

Multilayer Varistor for ESD pulse [DC voltage lines/High speed signal lines]

Series **EZJP**, 0201size



■ Features

- Excellent ESD suppression due to advanced material technology
- Meets IEC61000-4-2, Level 4 standard
- Can replace 2 Zener Diodes and 1 Capacitor
- Low capacitance versions for DC voltage lines of high speed busses
- Ultra low capacitance for signal lines of high speed busses
- RoHS compliant

■ Handling Precautions

see pages 8 to 13

■ Packaging Specifications

see pages 7

■ Explanation of Part Numbers

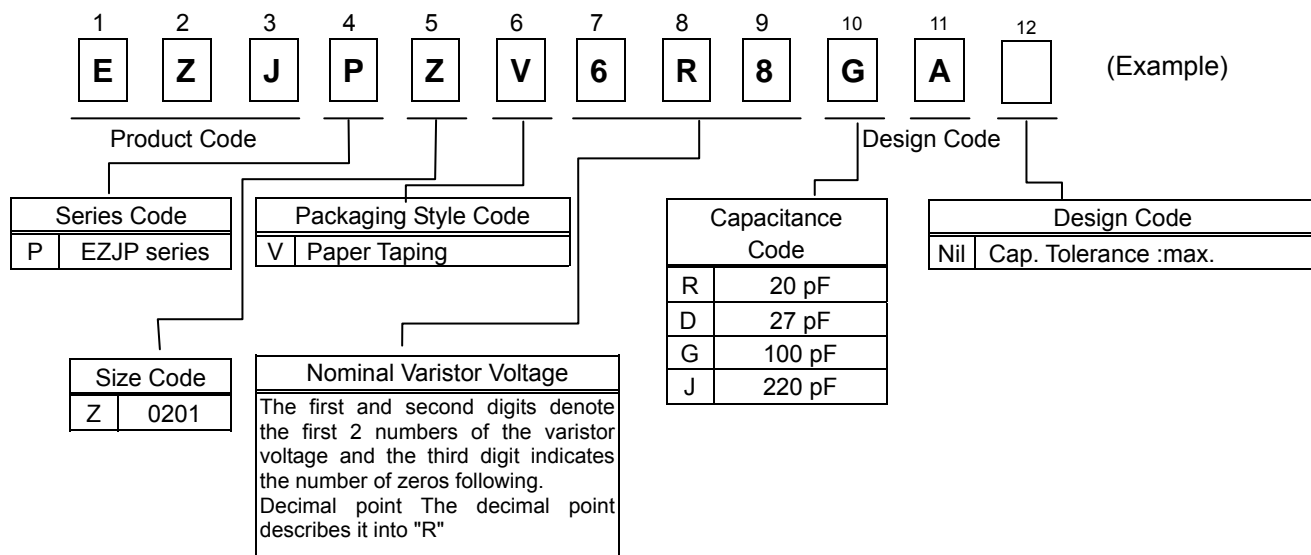

■ Construction

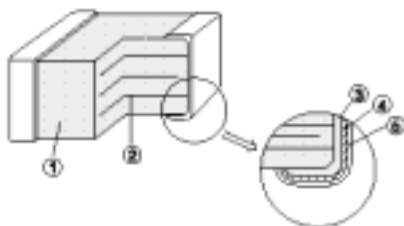

No.	Name	
①	Semiconductive Ceramics	
②	Internal electrode	
③	Terminal electrode	Substrate electrode
④		Intermediate electrode
⑤		External electrode

■ Dimensions in mm (not to scale)

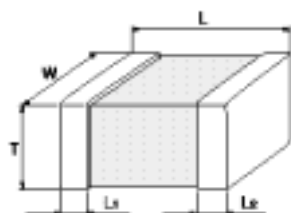

(Unit:mm)					
Size Code	Size	L	W	T	L ₁ , L ₂
Z	0201	0.60±0.03	0.30±0.03	0.30±0.03	0.15±0.05

Design and specifications are each subject to change without notice. Ask factory for the current technical specifications before purchase and/or use. Should a safety concern arise regarding this product, please be sure to contact us immediately.

Multilayer Varistor, Low Voltage Type (Standard Type) [DC voltage lines/Low speed signal lines]

■ Features

Multilayer monolithic ceramic construction
for use protecting DC voltage lines or signal lines

• Circuit voltage

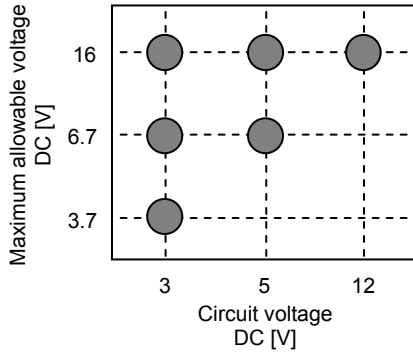

• Varistor voltage : 6.8 to 27V [at 1mA]

• Capacitance : 15 to 150pFtyp. [at 1MHz]

- 1 ■ Recommended Applications

Mobile phone	SW, LCD, LED, Audio terminal, Battery pack, Memory card, External IF
DSC, DVC	SW, LCD, LED, USB
PC, PDA	SW, LCD, LED, USB
TV, DVD	Audio, Video terminal
Audio	Audio terminal, Microphone, Receiver
Game console	Controller, External IF

■ Ratings and Characteristics

Size	Part No.	Maximum allowable voltage at DC (V)	Nominal varistor voltage at 1mA (V)	Capacitance (pF)		Maximum peak current at 8/20μs, 2times (A)	Maximum ESD at IEC61000-4-2
				at 1MHz	at 1kHz		
0201	EZJPZV6R8JA	3.7	6.8	220max	175typ.	5	Contact discharge 8kV
	EZJPZV6R8GA	3.7	6.8	100max	100typ.	5	
	EZJPZV120GA	6.7	12	100max	100typ.	5	
	EZJPZV120DA	6.7	12	27max	33typ.	1	
	EZJPZV270RA	16	27	20max.	16.5typ.	1	

● Operating Temperature Range : -40 to 85°C

* Recommend soldering method : Reflow soldering

Maximum Allowable Voltage	Maximum DC Voltage that can be applied continuously within the operating temperature range
Varistor Voltage	Varistor starting voltage between terminals at DC 1mA, also known as Breakdown voltage
Maximum Peak Current	Varistor's maximum current under the standard pulse 8/20μs, 2 times based on IEC60
Maximum ESD	Varistor's maximum voltage under ESD based on IEC61000-4-2, 10 times (5 times of each positive-negative polarity)

■ Voltage vs. Current

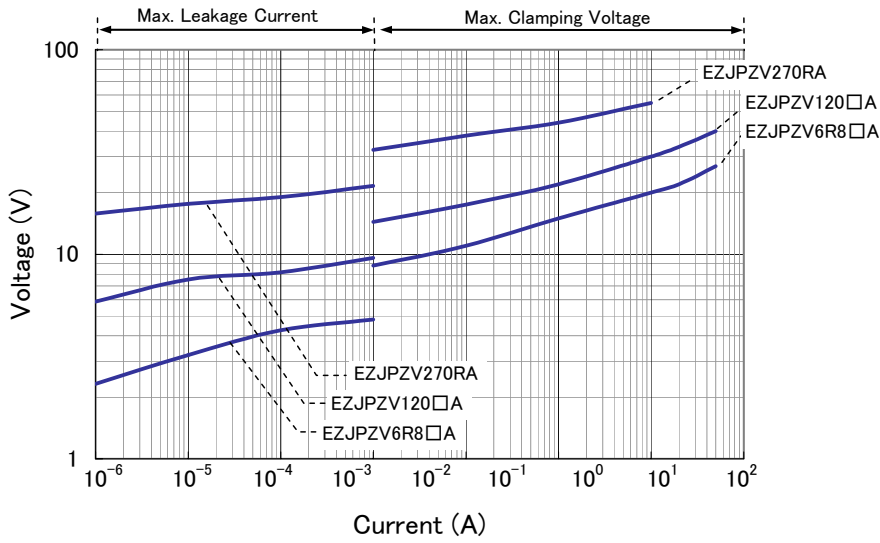

■ Frequency vs. Capacitance

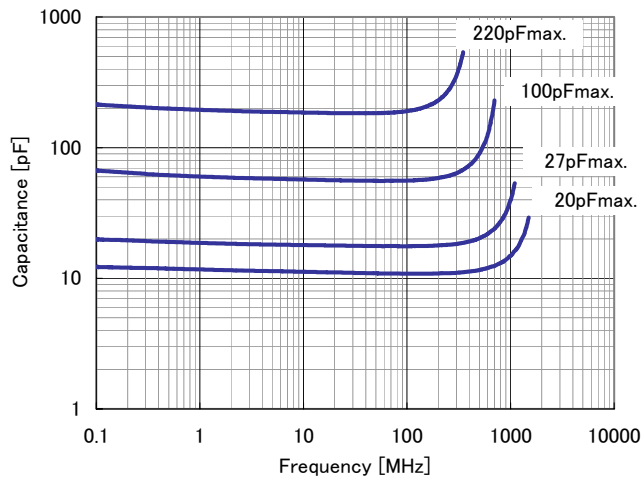

■ Frequency vs. Attenuation

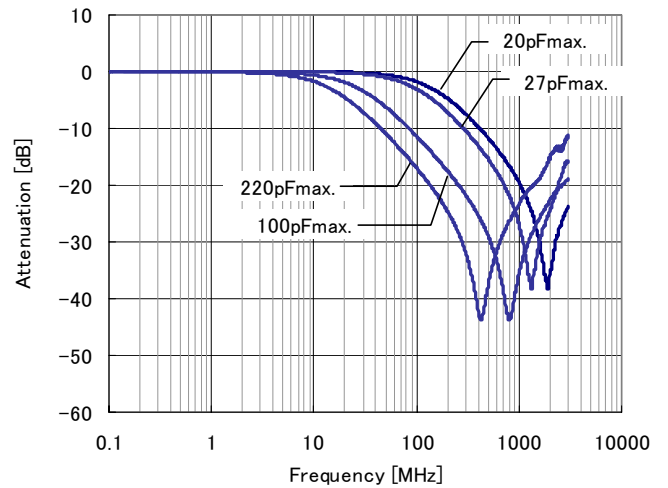

Design and specifications are each subject to change without notice. Ask factory for the current technical specifications before purchase and/or use. Should a safety concern arise regarding this product, please be sure to contact us immediately.

Varistor Characteristics and Equivalent Circuit

A Multilayer Varistor does not have an electrical polarity like zener diodes and is equivalent to total 3 pcs. of 2 zener diodes and 1 capacitor.

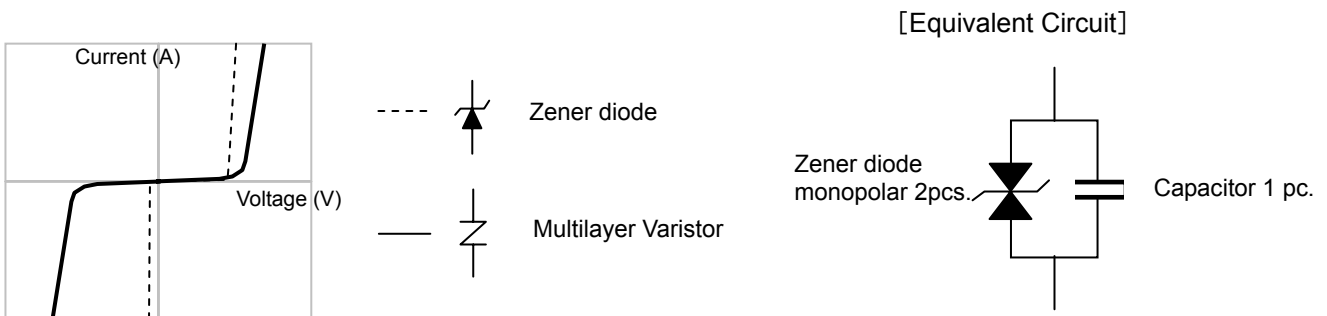

ESD Suppressive Effects

Typical effects of ESD suppression

Test conditions: IEC61000-4-2* Level 4 Contact discharge, 8kV

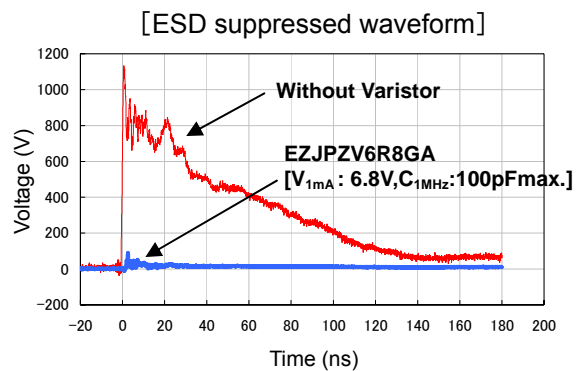
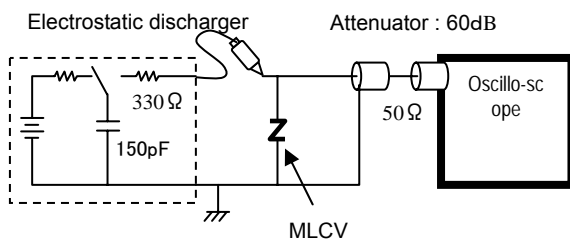

* IEC61000-4-2 ... International Standard of the ESD testing method (HBM) setting 4 levels of severity

Severity	Level 1	Level 2	Level 3	Level 4
Contact discharge	2kV	4kV	6kV	8kV
Air discharge	2kV	4kV	8kV	15kV

Replacement of Zener diode

Using a Multilayer Varistor to replace a "Zener diode & Capacitor" saves both the amount of space and number of components used.

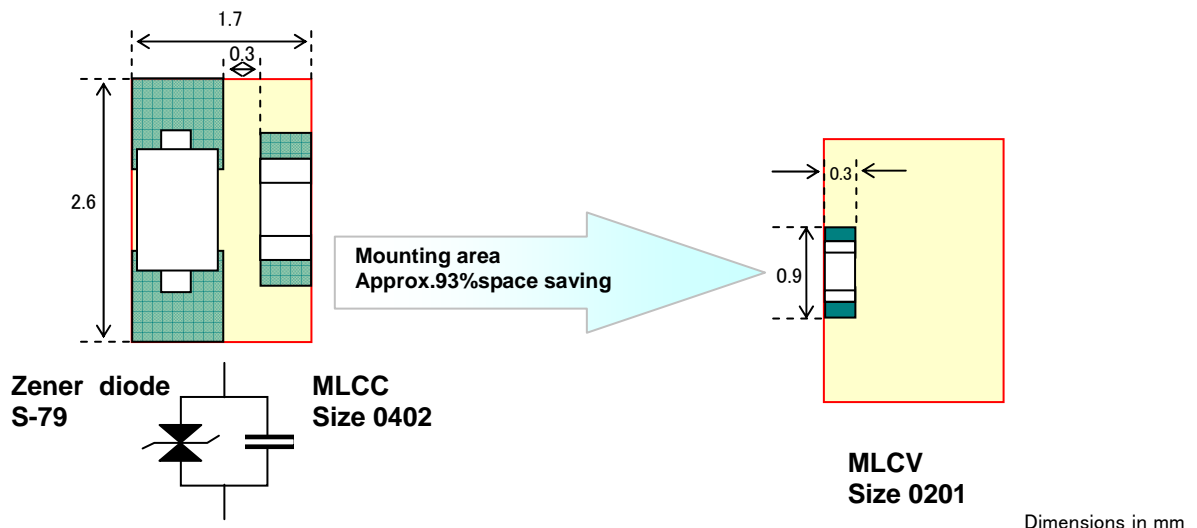

Design and specifications are each subject to change without notice. Ask factory for the current technical specifications before purchase and/or use. Should a safety concern arise regarding this product, please be sure to contact us immediately.

Recommended Applications

Applications	Series	Series	Circuit		
			DC 1k	1M	1G (Hz)
Mobile phones, DSC, PC, PDA, HDD TV (PDP, LC etc.), DVD, DVC, Game consoles, Audio equipment	Series EZJZ,P	Ultra low capacitance (Cap.:3pF or less)	[Grey Box]		DC to GHz Antenna, RF circuit, LVDS USB, IEEE1394, HDMI etc.
		Low capacitance (Cap.:20 to 680pF)	[Grey Box]		DC to millions of Hz PWR, SW, Audio terminals LCD, RS232C, etc.
PWR, Photoelectronic sensors, SSR, Motors, Pressure sensors, Proximity switches	Series EZJS	High capacitance (Cap.:1800 to 22000pF)	[Grey Box]		DC to thousands of Hz PWR, SW, Audio terminals etc.

Applications

Mobile Phone

- Audio lines

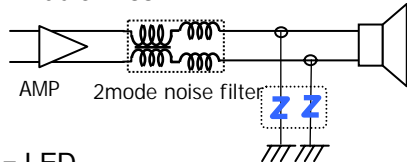

- LED

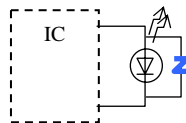

- SW/ Keyboard

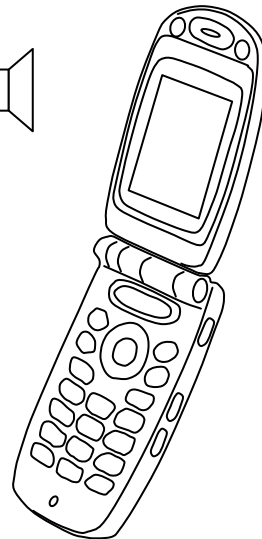
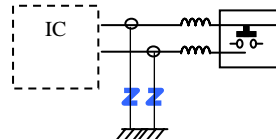

- LCD/Camera lines

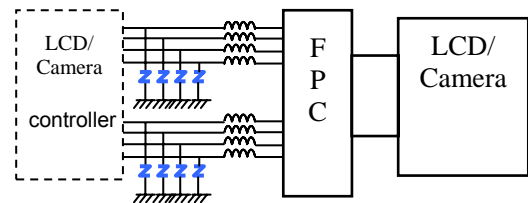

- I/O data lines

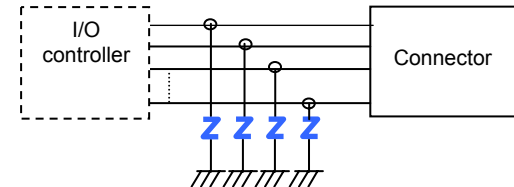

USB 1.1/2.0 lines

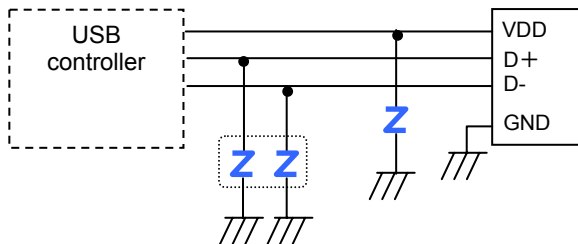

IEEE1394 lines

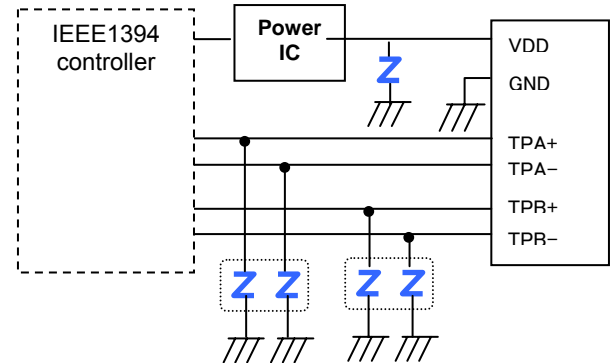

HDMI lines

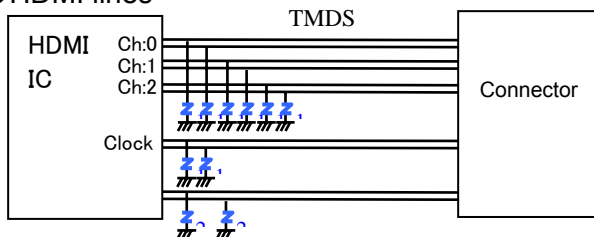

Design and specifications are each subject to change without notice. Ask factory for the current technical specifications before purchase and/or use. Should a safety concern arise regarding this product, please be sure to contact us immediately.

■ Performance and Testing Methods

Characteristics	Specifications	Testing Method															
Standard test conditions		Electrical characteristics shall be measured under the following conditions. Temp. : 5 to 35°C, Relative humidity : 85% or less															
Varistor voltage	To meet the specified value	The voltage between both end terminals of a varistor when the specified measuring current (C_{mA}) is applied to the Varistor (V_C , or V_{CmA} .) The measurement shall be made as quickly as possible to avoid heating effects.															
Maximum allowable voltage	To meet the specified value	The maximum DC voltage that can be applied continuously to a varistor															
Capacitance	To meet the specified value	Capacitance shall be measured at the specified frequency, bias voltage 0V, measuring voltage 0.2 to 2 Vrms.															
Maximum peak current	To meet the specified value	The maximum current measured (while the varistor voltage is within $\pm 10\%$ of its nominal value) when a standard impulse current of $8/20 \mu$ seconds is applied twice within an interval of 5 minutes.															
Maximum ESD	To meet the specified value	The maximum ESD measured (while the varistor voltage is within $\pm 30\%$ of its nominal value) when exposed to ESD 10 times (five times for each positive-negative polarity) based on IEC61000-4-2.															
Solderability	To meet the specified value	The part shall be immersed into a soldering bath under the conditions below. Solder: H63A Soldering flux: Ethanol solution of rosin (Concentration approx.25wt%) Soldering temp.: $230 \pm 5^\circ\text{C}$ Period: 4 ± 1 sec. Soldering position: So that both terminal electrodes are completely immersed in the soldering bath															
Resistance to soldering heat	$\Delta V_C / V_C$: within $\pm 10\%$	The part shall be immersed into a soldering bath under the conditions below (before being subjected to standard conditions) for 24 ± 2 hours to evaluate its characteristics. Soldering conditions: 270°C , 3s / 260°C , 10s Soldering position: So that both terminal electrodes are completely immersed in the soldering bath															
Temperature cycle	$\Delta V_C / V_C$: within $\pm 10\%$	Repeat the following cycle on the part for the specified number of times (before being subjected to standard conditions) for 24 ± 2 hours to evaluate its characteristics. Cycle : 5 cycles <table border="1" style="margin-left: auto; margin-right: auto;"> <thead> <tr> <th>Step</th> <th>Temperature</th> <th>Period</th> </tr> </thead> <tbody> <tr> <td>1</td> <td>Max. Operating Temp.</td> <td>30 min.</td> </tr> <tr> <td>2</td> <td>Ordinary temp.</td> <td>3 min.</td> </tr> <tr> <td>3</td> <td>Min. Operating Temp.</td> <td>30 min.</td> </tr> <tr> <td>4</td> <td>Ordinary temp.</td> <td>3 min.</td> </tr> </tbody> </table>	Step	Temperature	Period	1	Max. Operating Temp.	30 min.	2	Ordinary temp.	3 min.	3	Min. Operating Temp.	30 min.	4	Ordinary temp.	3 min.
Step	Temperature	Period															
1	Max. Operating Temp.	30 min.															
2	Ordinary temp.	3 min.															
3	Min. Operating Temp.	30 min.															
4	Ordinary temp.	3 min.															
Damp heat load	$\Delta V_C / V_C$: within $\pm 10\%$	The part shall be tested under the conditions below (before being subjected to standard conditions) for 24 ± 2 hours to evaluate its characteristics. Temp.: $40 \pm 2^\circ\text{C}$ Humidity: 90~95%RH Applied voltage: Maximum allowable voltage (Individually specified) Period: 500 + 24 / 0 h															
High temperature load	$\Delta V_C / V_C$: within $\pm 10\%$	The part shall be tested under the conditions below (before being subjected to standard conditions) for 24 ± 2 hours to evaluate its characteristics. Temp.: Maximum operating temperature $\pm 3^\circ\text{C}$ (Individually specified) Applied voltage: Maximum allowable voltage (Individually specified) Period : 500 + 24 / 0h															

Design and specifications are each subject to change without notice. Ask factory for the current technical specifications before purchase and/or use.
Should a safety concern arise regarding this product, please be sure to contact us immediately.

■ Packaging Specifications

● Standard Packing Quantities

Series	Size Code	Thickness (mm)	Paper Taping	
			Pitch (mm)	Q'ty (pcs./reel)
EZJP	Z (0201)	0.3	2	15,000

● Paper Taping

Pitch 2 mm (Pressed Carrier taping) : 0201

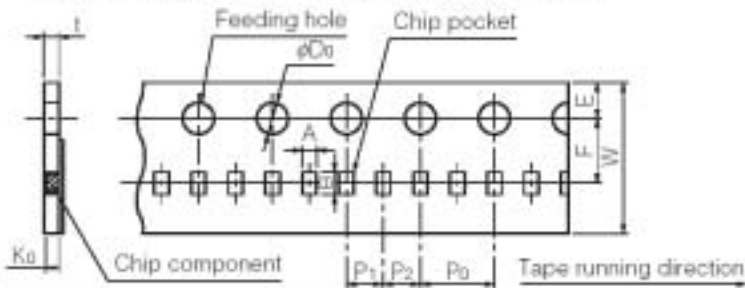

Symbol	A	B	W	F	E	P ₁	P ₂	P ₀	φD ₀	t	K ₀
Dim. (mm)	0.36 ±0.03	0.66 ±0.03	8.0 ±0.2	3.50 ±0.05	1.75 ±0.10	2.00 ±0.05	2.00 ±0.05	4.0 ±0.1	1.5 ^{+0.1} ₀	0.55 max.	0.36 ±0.03

● Reel for Taping

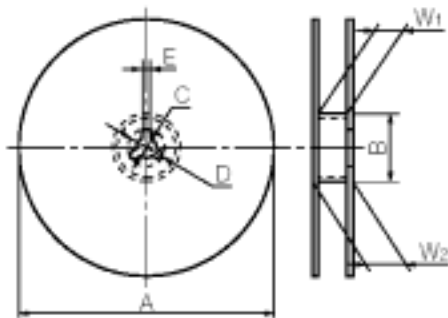

Symbol	φA	φB	C	D	E	W ₁	W ₂
Dim. (mm)	180 ^{-0.3} ₀	60.0 ^{+1.0} ₀	13.0±0.5	21.0±0.8	2.0±0.5	9.0 ^{+1.0} ₀	11.4±1.0

● Leader Part and Taped End

Leader part

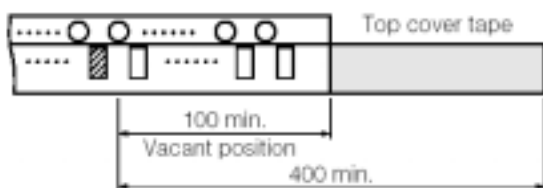

Taped end

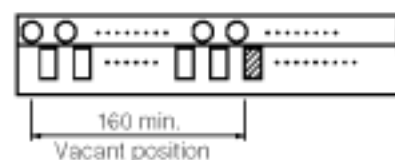

Multilayer Varistors ,Chip Type

Series : **EZJZ ,EZJP**(For DC voltage lines, high speed signal lines)

Series : **EZJS** (For DC voltage lines)

Handling Precautions

Safety Precautions

Multilayer Varistors (hereafter referred to as “Varistors”) should be used for general purpose applications as countermeasures against ESD and noise found in consumer electronics (audio/visual, home, office, information & communication) equipment. When subjected to severe electrical, environmental, and/or mechanical stress beyond the specifications, as noted in the Ratings and Specified Conditions section, the Varistors may fail in a short circuit mode or in an open-circuit mode. This case results in a burn-out, smoke or flaming.

For products which require high safety levels, please carefully consider how a single malfunction can affect your product. In order to ensure the safety in the case of a single malfunction, please design products with fail-safe, such as setting up protecting circuits, etc.

- For the following applications and conditions, please contact us for additional specifications not found in this document.
 - When your application may have difficulty complying with the safety or handling precautions specified below.
 - For any applications where a malfunction with this product may directly or indirectly cause hazardous conditions which could result in death or injury;
 - Aircraft and Aerospace Equipment (artificial satellite, rocket, etc.)
 - Submarine Equipment (submarine repeating equipment, etc.)
 - Transport Equipment (motor vehicles, airplanes, trains, ship, traffic signal controllers, etc.)
 - Power Generation Control Equipment (atomic power, hydroelectric power, thermal power plant control system, etc.)
 - Medical Equipment (life-support equipment, pacemakers, dialysis controllers, etc.)
 - Information Processing Equipment (large scale computer system, etc.)
 - Electric Heating Appliances, Combustion devices (gas fan heaters, oil fan heaters, etc.)
 - Rotary Motion Equipment
 - Security Systems
 - And any similar types of equipment

Strict Observance

1. Confirmation of Rated Performance

The Varistors shall be operated within the specified rating/performance.

Application exceeding the specifications may cause deteriorated performance and/or breakdown, resulting in degradation and/or smoking or ignition of products. The following are strictly observed.

- (1) The Varistors shall not be operated beyond the specified operating temperature range.
- (2) The Varistors shall not be operated in excess of the specified maximum allowable voltage.
- (3) The Varistors shall not be operated in the circuits to which surge current and ESD are applied exceeding the specified maximum peak current and maximum ESD.
- (4) Never use for AC power supply circuits.

2. The Varistors shall not be mounted near inflammables.

■ Operating Conditions and Circuit Design

1. Circuit Design

1.1 Operating Temperature and Storage Temperature

The specified “Operating Temperature Range” found in the Specification is the absolute maximum and minimum temperature rating. Every Varistor shall be operated within the specified “Operating

Temperature Range”.

The Varistors mounted on PCB shall be stored without operating within the specified “Storage Temperature Range” in the Specifications.

Design and specifications are each subject to change without notice. Ask factory for the current technical specifications before purchase and/or use. Should a safety concern arise regarding this product, please be sure to contact us immediately.

1.2 Operating Voltage

The Varistors shall not be operated in excess of the "Maximum allowable voltage". If the Varistors are operated beyond the specified Maximum allowable voltage, it may cause short and/or damage due to thermal run away. When high frequency and steep pulse voltages are continuously used, even when less than the Maximum allowable voltage, in a circuit, please examine the reliability of the Varistor while also checking the safety and reliability of your circuit. Check safety and reliability in your circuit.

1.3 Self-heating

The surface temperature of the Varistors shall be under the specified Maximum Operating Temperature in the Specifications including the temperature rise cause by self-heating. Check temperature rise of the Varistor in your circuit.

1.4 Environmental Restrictions

The Varistors shall not be operated and/or stored under the following conditions.

(1) Environmental conditions

- (a) Under direct exposure to water or salt water
- (b) Under conditions where water can condense and/or dew can form
- (c) Under conditions containing corrosive gases such as hydrogen sulfide, sulfurous acid, chlorine and ammonia

(2) Mechanical conditions

Under severe conditions of vibration or impact beyond the specified conditions found in the Specifications.

2. Design of Printed Circuit Board

2.1 Selection of Printed Circuit Boards

When the Varistors are mounted and soldered on an "Alumina Substrate", the substrate influences the Varistors' reliability against "Temperature Cycles" and "Heat shock" due to the difference in the thermal expansion coefficient between them. Confirm that the actual board used does not deteriorate the characteristics of the Varistors.

2.2 Design of Land Pattern

(1) Recommended land dimensions are shown below. Use the proper amount of solder in order to prevent cracking. Using too much solder places excessive stress on the Varistors.

Recommended Land Dimensions

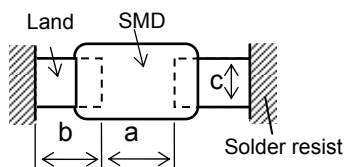

Size Code	Component dimensions			a	b	c
	L	W	T			
Z(0201)	0.6	0.3	0.3	0.2 to 0.3	0.2 to 0.3	0.2 to 0.3
0(0402)	1.0	0.5	0.5	0.4 to 0.5	0.4 to 0.5	0.4 to 0.5
1(0603)	1.6	0.8	0.8	0.8 to 1.0	0.6 to 0.8	0.6 to 0.8
2(0805)	2.0	1.25	0.8 to 1.25	0.8 to 1.2	0.8 to 1.0	0.8 to 1.0

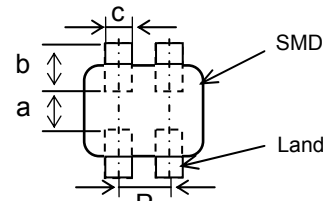

Size Code	Component dimensions			a	b	C	P
	L	W	T				
S (0504 2Array)	1.37	1.0	0.6	0.3~ 0.4	0.45~ 0.55	0.3~ 0.4	0.54~ 0.74

- (2) The size of lands shall be designed to have equal spacing between the right and left sides. If the amount of solder on the right land is different from that on the left land, the component may be cracked by stress since the side with a larger amount of solder solidifies later during cooling.

Recommended Amount of Solder

- (a) Excessive amount (b) Proper amount (c) Insufficient amount

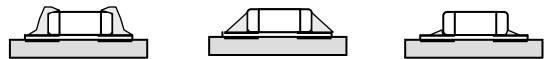

2.3 Utilization of Solder Resist

- (1) Solder resist shall be utilized to equalize the amounts of solder on both sides.
 (2) Solder resist shall be used to divide the pattern for the following cases;
- Components are arranged closely.
 - The Varistor is mounted near a component with lead wires.
 - The Varistor is placed near a chassis.
- See the table below.

Prohibited Applications and Recommended Applications

Item	Prohibited applications	Improved applications by pattern division
Mixed mounting with a component with lead wires	The lead wire of a component with lead wires	Solder resist
Arrangement near chassis	Chassis Solder (Ground solder) Electrode pattern	Solder resist
Retro-fitting of component with lead wires	A lead wire of Retro-fitted component Soldering iron	Solder resist
Lateral arrangement	Portion to be expressly soldered Land	Solder resist

2.4 Component Layout

Design and specifications are each subject to change without notice. Ask factory for the current technical specifications before purchase and/or use. Should a safety concern arise regarding this product, please be sure to contact us immediately.

The Varistors/components shall be placed on the PC board such that both electrodes are subjected to uniform stresses, or to position the component electrodes at right angles to the grid glove or bending line. This should be done to avoid cracking the Varistors from bending the PC board after or during placing/mounting on the PC board.

- (1) To minimize mechanical stress caused by the warp or bending of a PC board, please follow the recommended Varistors' layout below.

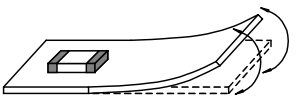
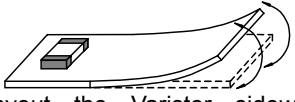
Prohibited	Recommended layout
	 Layout the Varistor sideways against the stressing direction.

- (2) The following layout is for your reference since mechanical stress near the dividing/breaking position of a PC board varies depending on the mounting position of the Varistors.

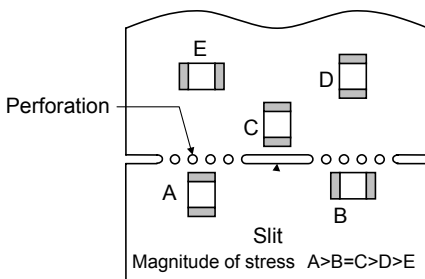

- (3) The magnitude of mechanical stress applied to the Varistors when the circuit board is divided is in the order of push back < slit < V-groove < perforation. Also take into account the layout of the Varistors and the dividing/breaking method.

2.5 Mounting Density and Spaces

If components are arranged in too narrow a space, the components can be affected by solder bridges and solder balls. The space between components should be carefully determined.

■ Precautions for Assembly

1. Storage

- (1) The Varistors shall be stored between 5 – 40°C and 20 - 70%RH, not under severe conditions of high temperature and humidity.
- (2) If stored in a place that is humid, dusty, or contains corrosive gasses (hydrogen sulfide, sulfurous acid, hydrogen chloride and ammonia etc.), the solderability of terminal electrodes may deteriorate. In addition, storage in a place subjected to heating and/or exposure to direct sunlight will cause deformed tapes and reels, and component sticking to tapes, both of which can result in mounting problems.
- (3) Do not store components longer than 6 months. Check the solderability of products that have been stored for more than 6 months before use.

2. Adhesives for Mounting

- (1) The amount and viscosity of an adhesive for mounting shall be such that the adhesive shall not flow off on the land during its curing.
- (2) If the amount of adhesive is insufficient for mounting, the Varistors may fall off after or during soldering.
- (3) If the adhesive is too low in its viscosity, the Varistors may be out of alignment after or during soldering.
- (4) Adhesives for mounting can be cured by ultraviolet or infrared radiation. In order to prevent the terminal electrodes of the Varistors from oxidizing, the curing shall be done under the following conditions:
160°C max., for 2 minutes max.
- (5) Insufficient curing may cause the Varistors to fall off after or during soldering. In addition, insulation resistance between terminal electrodes may deteriorate due to moisture absorption. In order to prevent these problems, please observe proper curing conditions.

3. Chip Mounting Consideration

- (1) When mounting the Varistors/components on a PC board, the Varistor bodies shall be free from excessive impact loads such as mechanical impact or stress due to the positioning, pushing force and displacement of vacuum nozzles during mounting.
- (2) Maintenance and inspection of the Chip Mounter must be performed regularly.
- (3) If the bottom dead center of the vacuum nozzle is too low, the Varistor will crack from excessive force during mounting.

The following precautions and recommendations are for your reference in use.

- (a) Set and adjust the bottom dead center of the vacuum nozzles to the upper surface of the PC board after correcting the warp of the PC board.
- (b) Set the pushing force of the vacuum nozzle during mounting to 1 to 3 N in static load.
- (c) For double surface mounting, apply a supporting pin on the rear surface of the PC board to suppress the bending of the PC board in order to minimize the impact of the vacuum nozzles.

Typical examples are shown in the table below.

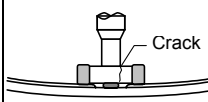
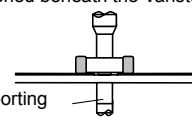
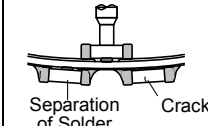
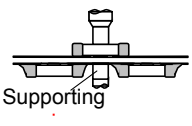
Item	Prohibited mounting	Recommended mounting
Single surface mounting	 Crack	 Supporting pin
Double surface mounting	 Separation of Solder Crack	 Supporting

Design and specifications are each subject to change without notice. Ask factory for the current technical specifications before purchase and/or use. Should a safety concern arise regarding this product, please be sure to contact us immediately.

- (d) Adjust the vacuum nozzles so that their bottom dead center during mounting is not too low.
- (4) The closing dimensions of the positioning chucks shall be controlled. Maintenance and replacement of positioning chucks shall be performed regularly to prevent chipping or cracking of the Varistors caused by mechanical impact during positioning due to worn positioning chucks.
- (5) Maximum stroke of the nozzle shall be adjusted so that the maximum bending of PC board does not exceed 0.5mm at 90 mm span. The PC board shall be supported by an adequate number of supporting pins.

4. Selection of Soldering Flux

Soldering flux may seriously affect the performance of the Varistors. The following shall be confirmed before use.

- (1) The soldering flux should have a halogen based content of 0.1 wt% (converted to chlorine) or below. Do not use soldering flux with strong acid.
- (2) When applying water-soluble soldering flux, wash the Varistors sufficiently because the soldering flux residue on the surface of PC boards may deteriorate the insulation resistance on the Varistors' surface.

5. Soldering

5.1 Flow Soldering

For flow soldering, abnormal and large thermal and mechanical stress, caused by the "Temperature Gradient" between the mounted Varistors and melted solder in a soldering bath may be applied directly to the Varistors, resulting in failure and damage of the Varistors. Therefore it is essential that soldering process follow these recommended conditions.

- (1) Application of Soldering flux:
The soldering flux shall be applied to the mounted Varistors thinly and uniformly by foaming method.
- (2) Preheating:
The mounted Varistors/Components shall be pre-heated sufficiently so that the "Temperature Gradient" between the Varistors/Components and the melted solder shall be 150 °C max. (100 to 130°C)
- (3) Immersion into Soldering bath:
The Varistors shall be immersed into a soldering bath of 240 to 260 °C for 3 to 5 seconds.
- (4) Gradual Cooling:
The Varistors shall be cooled gradually to room ambient temperature with the cooling temperature rates of 8 °C /s max. from 250°C to 170 °C and 4 °C/s max. from 170 °C to 130°C.
- (5) Flux Cleaning:
When the Varistors are immersed into a cleaning solvent, be sure that the surface temperatures of devices do not exceed 100 °C.
- (6) Performing flow soldering once under the conditions shown in the figure below [Recommended profile of Flow soldering (Ex)] will not cause any problems. However, pay attention to the possible warp and bending of the PC board.

Recommended profile for Flow soldering [Ex.]

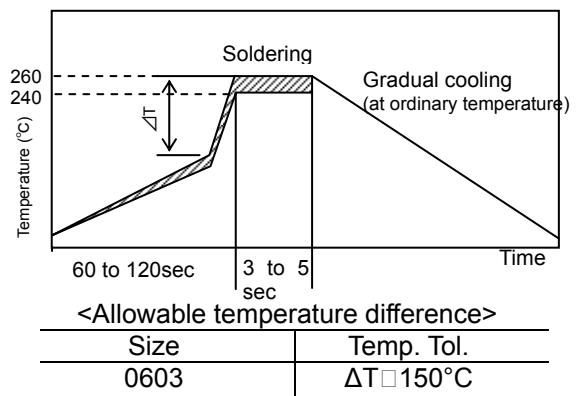

For products specified in individual specifications, avoid flow soldering.

5.2 Reflow Soldering

The reflow soldering temperature conditions are each temperature curves of Preheating, Temp. rise, Heating, Peak and Gradual cooling.

Large temperature difference caused by rapid heat application to the Varistors may lead to excessive thermal stresses, contributing to the thermal cracks.

The Preheating temperature requires controlling with great care so that tombstone phenomenon may be prevented.

Item	Temperature	Period or Speed
□ Preheating	140 to 180°C	60 to 120 sec
□ Temp. rise	Preheating temp to Peak temp.	2 to 5°C /sec
□ Heating	220°C min.	60 sec max.
□ Peak	260°C max.	10 sec max.
□ Gradual cooling	Peak temp. to 140°C	1 to 4°C /sec

Recommended profile of Reflow soldering (EX)

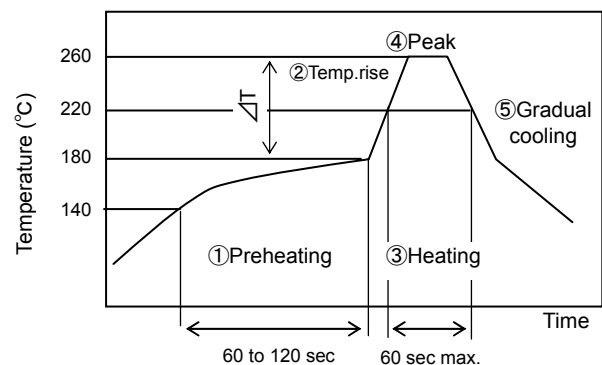

ΔT : Allowable temperature difference ΔT □ 150°C

The rapid cooling (forced cooling) during Gradual cooling part should be avoided, because this may cause defects such as the thermal cracks, etc.

When the Varistors are immersed into a cleaning solvent, make sure that the surface temperatures of the devices do not exceed 100□.

Design and specifications are each subject to change without notice. Ask factory for the current technical specifications before purchase and/or use. Should a safety concern arise regarding this product, please be sure to contact us immediately.

Performing reflow soldering twice under the conditions shown in the figure above [Recommended profile of Reflow soldering (EX)] will not cause any problems. However, pay attention to the possible warp and bending of the PC board.

5.3 Hand Soldering

Hand soldering typically causes significant temperature change, which may induce excessive thermal stresses inside the Varistors, resulting in the thermal cracks, etc. In order to prevent any defects, the following should be observed;

- The temperature of the soldering tips should be controlled with special care.
- The direct contact of soldering tips with the Varistors and/or terminal electrodes should be avoided.
- Dismounted Varistors shall not be reused.

(1) Condition 1 (with preheating)

(a) Soldering:

Φ1.0mm Thread eutectic solder with soldering flux* in the core.

*Rosin-based and non-activated flux is Recommended.

(b) Preheating:

The Varistors shall be preheated so that the "Temperature Gradient" between the devices and the tip of soldering iron is 150°C or below.

(c) Temperature of Iron tip: 300°C max.

(The required amount of solder shall be melted in advance on the soldering tip.)

(d) Gradual cooling:

After soldering, the Varistors shall be cooled gradually at room temperature.

Recommended profile of Hand soldering (EX)

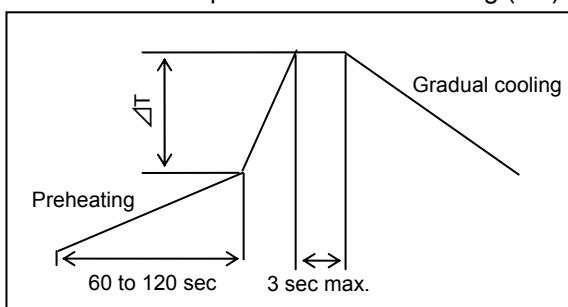

ΔT : Allowable temperature difference $\Delta T \leq 150^\circ\text{C}$

(2) Condition 2 (without preheating)

Hand soldering can be performed without preheating, by following the conditions below:

- (a) Soldering iron tip shall never directly touch the ceramic and terminal electrodes of the Varistors.
- (b) The lands are sufficiently preheated with a soldering iron tip before sliding the soldering iron tip to the terminal electrodes of the Varistors for soldering.

Conditions of Hand soldering without preheating

Conditions of Hand soldering without preheating	
	Condition
Temperature of Iron tip	270 °C max.
Wattage	20 W max.
Shape of Iron tip	φ3 mm max.
Soldering time with a soldering iron	3 sec max.

6. Post Soldering Cleaning

6.1 Cleaning solvent

Soldering flux residue may remain on the PC board if cleaned with an inappropriate solvent. This may deteriorate the electrical characteristics and reliability of the Varistors.

6.2 Cleaning conditions

Inappropriate cleaning conditions such as insufficient cleaning or excessive cleaning may impair the electrical characteristics and reliability of the Varistors.

(1) Insufficient cleaning can lead to:

(a) The halogen substance found in the residue of the soldering flux may cause the metal of terminal electrodes to corrode.

(b) The halogen substance found in the residue of the soldering flux on the surface of the Varistors may change resistance values.

(c) Water-soluble soldering flux may have more remarkable tendencies of (a) and (b) above compared to those of rosin soldering flux.

(2) Excessive cleaning can lead to:

(a) Overuse of ultrasonic cleaning may deteriorate the strength of the terminal electrodes or cause cracking in the solder and/or ceramic bodies of the Varistors due to vibration of the PC boards.

Please follow these conditions for Ultrasonic cleaning:

Ultrasonic wave output: 20 W/L max.

Ultrasonic wave frequency: 40 kHz max.

Ultrasonic wave cleaning time: 5 min. max.

6.3 Contamination of Cleaning solvent

Cleaning with contaminated cleaning solvent may cause the same results as insufficient cleaning due to the high density of liberated halogen.

7. Inspection Process

When mounted PC boards are inspected with measuring terminal pins, abnormal and excess mechanical stress shall not be applied to the PC board or mounted components, to prevent failure or damage to the devices.

(1) Mounted PC boards shall be supported by an adequate number of supporting pins with bend settings of 90 mm span 0.5 mm max.

(2) Confirm that the measuring pins have the right tip shape, are equal in height and are set in the correct positions.

The following figures are for your reference to avoid bending the PC board.

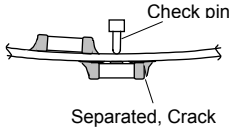
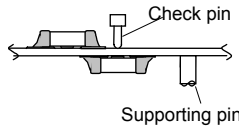
	Prohibited setting	Recommended setting
Bending of PC board		

8. Protective Coating

When the surface of a PC board on which the Varistors have been mounted is coated with resin to protect against moisture and dust, it shall be confirmed that the protective coating which is corrosive or chemically active is not used, in order that the reliability of the Varistors in the actual equipment may not be influenced. Coating materials that expand or shrink also may lead to damage to the Varistor during the curing process.

9. Dividing/Breaking of PC Boards

- (1) Abnormal and excessive mechanical stress such as bending or torsion shown below can cause cracking in the Varistors.

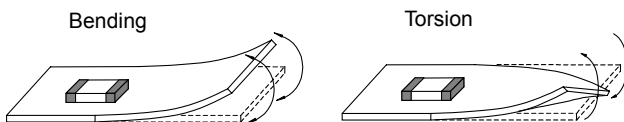

- (2) Dividing/Breaking of the PC boards shall be done carefully at moderate speed by using a jig or apparatus to prevent the Varistors on the boards from mechanical damage.

- (3) Examples of PCB dividing/breaking jigs:

The outline of PC board breaking jig is shown below.

When PC board are broken or divided, loading points should be close to the jig to minimize the extent of the bending.

Also, planes with no parts mounted on should be used as plane of loading, which generates a compressive stress on the mounted plane, in order to prevent tensile stress induced by the bending, which may cause cracks of the Varistors or other parts mounted on the PC boards.

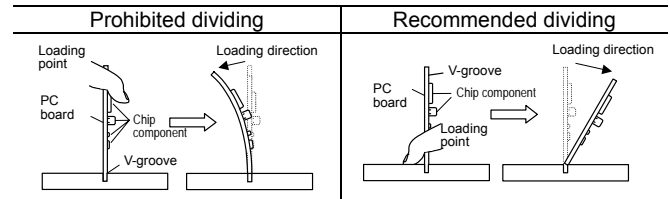
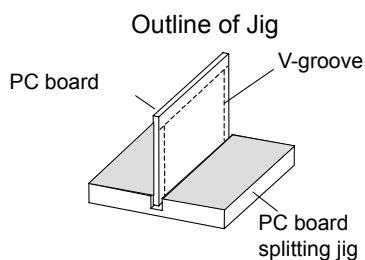

9. Mechanical Impact

- (1) The Varistors shall be free from any excessive mechanical impact. The Varistor body is made of ceramics and may be damaged or cracked if dropped.

Never use a Varistor which has been dropped; their quality may be impaired and failure rate increased.

- (2) When handling PC boards with Varistors mounted on them, do not allow the Varistors to collide with another PC board.

When mounted PC boards are handled or stored in a stacked state, impact between the corner of a PC board and the Varistor may cause damage or cracking and can deteriorate the withstand voltage and insulation resistance of the Varistor.

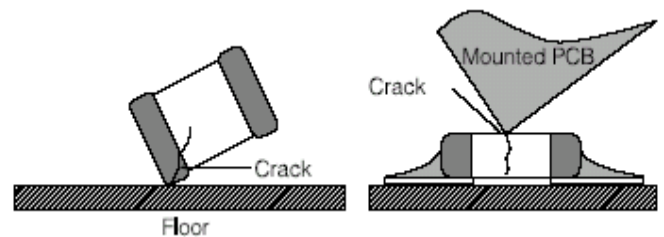

■ Other

The various precautions described above are typical. For special mounting conditions, please contact us.