

Am2855 • Am2856 • Am2857

Quad 128-Bit, Dual 256-Bit and Single 512-Bit Static Shift Registers

Distinctive Characteristics

- High-speed replacement for National 5055/6/7
- Internal recirculate
- Single TTL compatible clock
- Operation guaranteed from DC to 2.5MHz
- 100% reliability assurance testing in compliance with MIL-STD-883

FUNCTIONAL DESCRIPTION

These devices are a family of static P-channel MOS shift registers in three configurations. The Am2855 is a quad 128-bit register; the Am2856 is a dual 256-bit register; and the Am2857 is a single 512-bit register. All three devices include on chip recirculate. The registers are all clocked by a single low-level clock input. Because the registers are static, the clock may be stopped indefinitely in the LOW state without loss of data. Each of the registers has a single data input; data on the input is written into the register on the HIGH-to-LOW clock edge. A single recirculate control (RC) on each chip determines whether the registers on that chip are to write data in from the data inputs or recirculate the data appearing on the output. If RC is LOW, new data is written in; if RC is HIGH then the data on the output will be written back into the register input on the next clock pulse.

LOGIC SYMBOLS

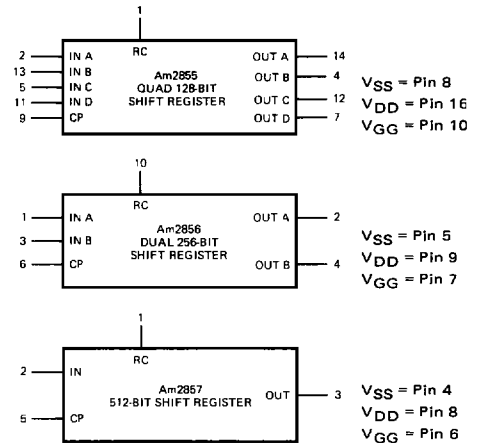

MOS-440

LOGIC BLOCK DIAGRAM (One Register Shown)

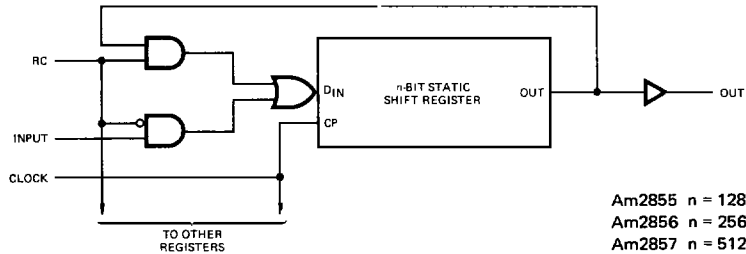

MOS-441

ORDERING INFORMATION

Package Type	Temperature Range	Order Number
16-Pin Molded DIP	0°C to +70°C	AM2855PC
16-Pin Hermetic DIP	0°C to +70°C	AM2855DC
16-Pin Hermetic DIP	-55°C to +125°C	AM2855DM
10-Pin Plastic DIP	0°C to +70°C	AM2856PC
TO-100 Can	0°C to +70°C	AM2856HC
TO-100 Can	-55°C to +125°C	AM2856HM
8-Pin Molded DIP	0°C to +70°C	AM2857PC
8-Pin Hermetic DIP	0°C to +70°C	AM2857DC
8-Pin Hermetic DIP	-55°C to +125°C	AM2857DM

CONNECTION DIAGRAMS

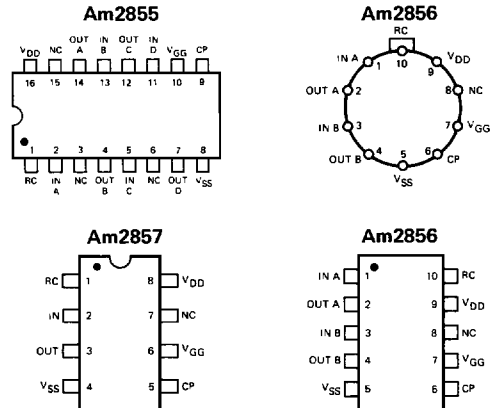

MOS-442

MAXIMUM RATINGS (Above which the useful life may be impaired)

Storage Temperature	-65°C to +160°C
Temperature (Ambient) Under Bias	-55°C to +125°C
V _{DD} Supply Voltage	V _{SS} -10V to V _{SS} +0.3V
V _{GG} Supply Voltage	V _{SS} -20V to V _{SS} +0.3V
V _{IC} Input Voltage	V _{SS} -20V to V _{SS} +0.3V

OPERATING RANGE

Part Number	Ambient Temperature	V _{SS}	V _{DD}	V _{GG}
Am2855DM Am2856HM Am2857DM	-55°C to +125°C	5.0V ±5%	0V	-12V ±5%
Am2855PC, DC Am2856HC Am2857PC, DC	0°C to +70°C	5.0V ±5%	0V	-12V ±5%

5

ELECTRICAL CHARACTERISTICS OVER OPERATING RANGE (Unless Otherwise Noted)

Parameters	Description	Test Conditions	Min.	Typ. (Note 1)	Max.	Units
V _{OH}	Output HIGH Voltage	I _{OH} = -0.5mA	2.4			Volts
V _{OL}	Output LOW Voltage	I _{OL} = 1.6mA			0.4	Volts
V _{IH}	Input HIGH Level	Guaranteed input logical HIGH voltage for all inputs	V _{SS} -1.0		V _{SS} +0.3	Volts
V _{IL}	Input LOW Level	Guaranteed input logical LOW voltage for all inputs	V _{SS} -18.5		V _{SS} -4.2	Volts
I _{IL}	Input Leakage Current	V _{IN} = -10.0V, all other pins GND, T _A = 25°C		0.01	0.5	μA
I _{DD}	V _{DD} Power Supply Current	T _A = 25°C, t _{oppwH} = 160 ns Data = 1010... output open f = 2.5 MHz		20.0	28.0	mA
I _{GG}	V _{GG} Power Supply Current			12.0	16.0	

Note: 1. Typical Limits are at V_{SS} = 5.0V, V_{GG} = -12V, 25°C ambient and maximum loading.

SWITCHING CHARACTERISTICS OVER OPERATING RANGE (Unless Otherwise Noted)

Parameters	Description	Test Conditions	Min.	Typ.	Max.	Units
f	Clock Frequency		0		2.5	MHz
t _{opwH}	Clock HIGH Time		0.16		10.0	μs
t _{opwL}	Clock LOW Time		0.200		∞	μs
t _r , t _f	Clock Rise and Fall Times		10		200	ns
t _s	Set-up Time, D or RC Inputs (see definitions)	t _r = t _f = 50ns	100			ns
t _h	Hold Time, D or RC Inputs (see definitions)	t _r = t _f = 50ns	40			ns
t _{pd}	Delay, Clock to Output LOW or HIGH	R _L = 4k, C _L = 10pF	(Note 3)	160	280	ns
C _{in}	Capacitance, Data In and RC Inputs (Note 2)	f = 1MHz, V _{IN} = V _{SS}		3	7	pF
C _φ	Capacitance, Clock Input (Note 2)	f = 1MHz, V _{IN} = V _{SS}		3	7	pF

Notes: 2. This parameter is periodically sampled but not 100% tested. It is guaranteed by design.

3. At any temperature, t_{pd} min. is always much greater than t_h(D) max.

TIMING DIAGRAM

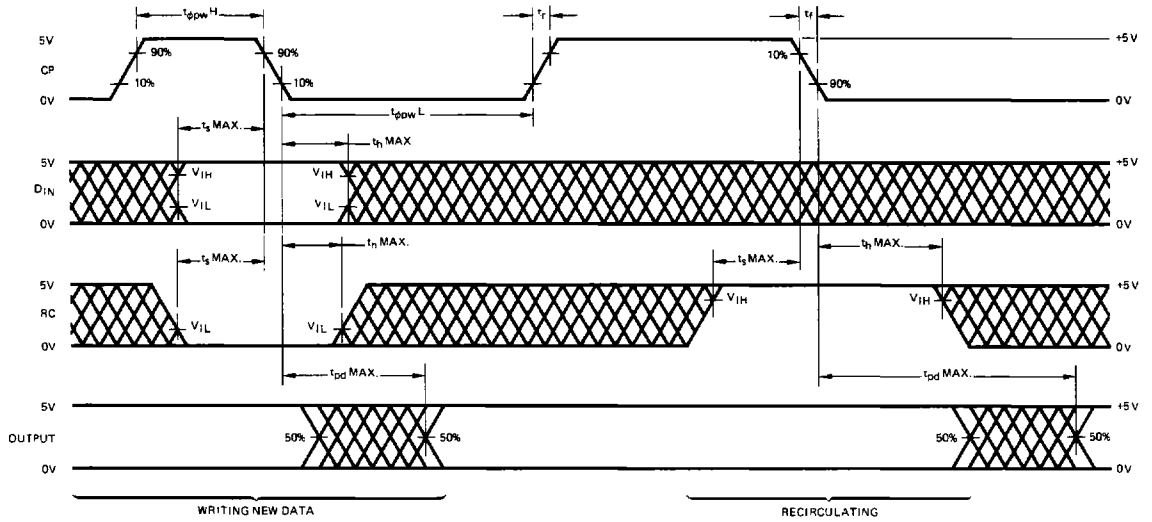

MOS-443

KEY TO TIMING DIAGRAM

WAVEFORM	INPUTS	OUTPUTS
—	MUST BE STEADY	WILL BE STEADY
▨	MAY CHANGE FROM H TO L	WILL BE CHANGING FROM H TO L
▩	MAY CHANGE FROM L TO H	WILL BE CHANGING FROM L TO H
▧	DON'T CARE: ANY CHANGE PERMITTED	CHANGING: STATE UNKNOWN

PERFORMANCE CURVES

Typical Data Output HIGH Current Versus Data Output Voltage

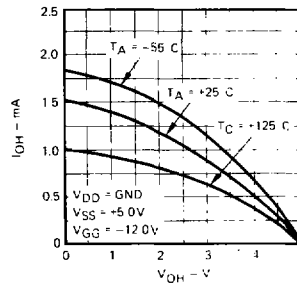

Typical Power-Supply Currents Versus Frequency

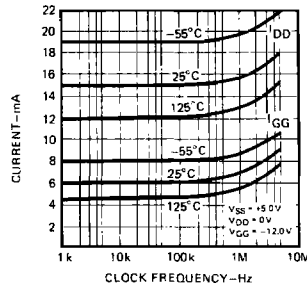

Typical Propagation Delay Versus Ambient Temperature

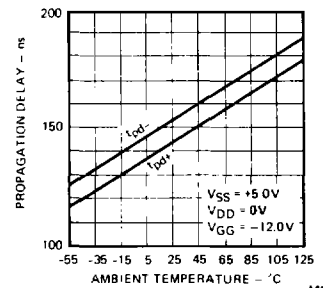

MOS-444

DEFINITION OF TERMS

STATIC SHIFT REGISTER A shift register that is capable of maintaining stored data without being continuously clocked. Most static shift registers are constructed with dynamic master and static slave flip-flops. The data is stored dynamically while the clock is HIGH and is transferred to the static slaves while the clock is LOW. The clock may be stopped indefinitely in the LOW state, but there are limitations on the time it may reside in the HIGH state.

SET-UP and HOLD TIMES The shift register will accept the data that is present on its input around the time the clock goes from HIGH-to-LOW. Because of variations in individual devices, there is some uncertainty as to exactly when, relative to this clock transition, the data will be stored. The set-up and hold times define the limits on this uncertainty. To guarantee storing the correct data, the data inputs should not be changed between the maximum set-up time before the clock transition and the maximum hold time after the clock transition. Data changes within this interval may or may not be detected.

Metalization and Pad Layouts

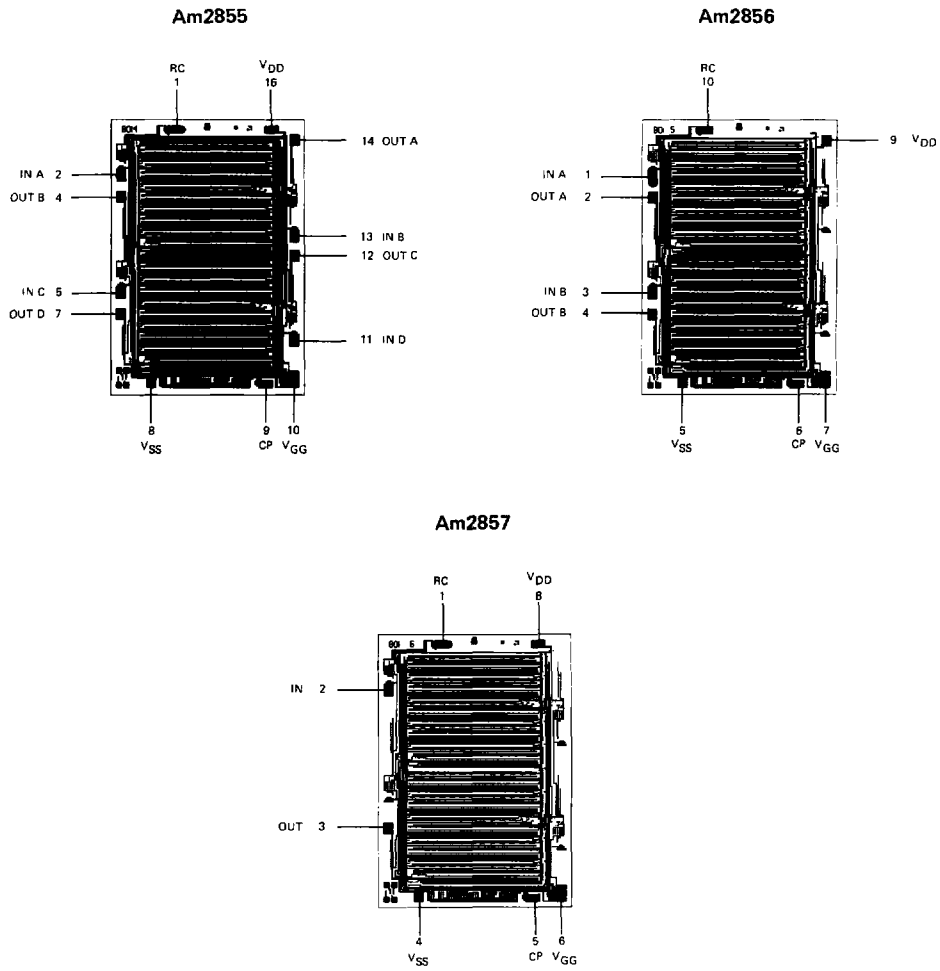

DIE SIZES: 0.101" X 0.142"

5