



Integrated Device Technology, Inc.

FAST CMOS QUAD 2-INPUT MULTIPLEXER

IDT54/74FCT157T/AT/CT/DT
IDT54/74FCT257T/AT/CT/DT

FEATURES:

- Std., A, C and D speed grades
- Low input and output leakage $\leq 1\mu\text{A}$ (max.)
- CMOS power levels
- True TTL input and output compatibility
 - $V_{OH} = 3.3\text{V}$ (typ.)
 - $V_{OL} = 0.3\text{V}$ (typ.)
- High drive outputs (-15mA I_{OH} , 48mA I_{OL})
- Power off disable outputs permit "live insertion"
- Meets or exceeds JEDEC standard 18 specifications
- Product available in Radiation Tolerant and Radiation Enhanced versions
- Military product compliant to MIL-STD-883, Class B and DESC listed (dual marked)
- Available in DIP, SOIC, QSOP, CERPACK and LCC packages

DESCRIPTION:

The IDT54/74FCT157T/AT/CT/DT and IDT54/74FCT257T/AT/CT/DT are high-speed quad 2-input multiplexers built using an advanced dual metal CMOS technology. Four bits of data from two sources can be selected using the common select input. The four buffered outputs present the selected data in the true (non-inverting) form.

The IDT54/74FCT157T/AT/CT/DT has a common, active-LOW, enable input. When the enable input is not active, all four outputs are held LOW. A common application of 'FCT157T is to move data from two different groups of registers to a common bus. Another application is as a function generator. The 'FCT157T can generate any four of the 16 different functions of two variables with one variable common.

The IDT54/74FCT257T/AT/CT/DT has a common Output Enable (\overline{OE}) input. When \overline{OE} is HIGH, all outputs are switched to a high-impedance state allowing the outputs to interface directly with bus-oriented systems.

FUNCTIONAL BLOCK DIAGRAM

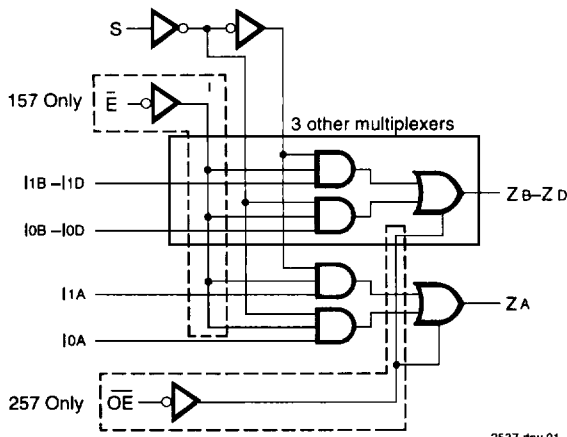

2537 drw 01

PIN CONFIGURATIONS

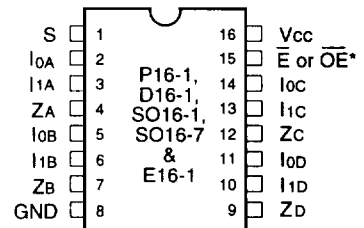

2537 drw 02

DIP/SOIC/QSOP/CERPACK TOP VIEW

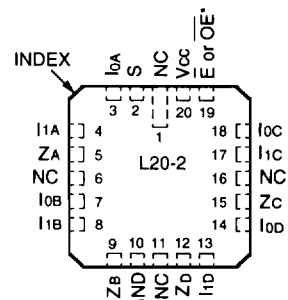

2537 drw 03

LCC TOP VIEW

* \overline{E} for FCT157, \overline{OE} for FCT257.

The IDT logo is a registered trademark of Integrated Device Technology, Inc.

MILITARY AND COMMERCIAL TEMPERATURE RANGES

APRIL 1994

PIN DESCRIPTION

Pin Names	Description
I0A-I0D	Source 0 Data Inputs
I1A-I1D	Source 1 Data Inputs
\bar{E}	Enable Input (Active LOW)-FCT157T
\bar{OE}	Output Enable (Active LOW)-FCT257T
S	Select Input
ZA-ZD	Outputs

2537 Inl 01

FUNCTION TABLE⁽¹⁾

Inputs				Output Zn	
\bar{E}/\bar{OE}	S	I0	I1	157	257
H	X	X	X	L	Z
L	H	X	L	L	L
L	H	X	H	H	H
L	L	L	X	L	L
L	L	H	X	H	H

2537 Inl 02

NOTE:

- H = HIGH Voltage Level
 L = LOW Voltage Level
 X = Don't Care
 Z = High Impedance

ABSOLUTE MAXIMUM RATINGS⁽¹⁾

Symbol	Rating	Commercial	Military	Unit
VTERM ⁽²⁾	Terminal Voltage with Respect to GND	-0.5 to +7.0	-0.5 to +7.0	V
VTERM ⁽³⁾	Terminal Voltage with Respect to GND	-0.5 to Vcc +0.5	-0.5 to Vcc +0.5	V
TA	Operating Temperature	0 to +70	-55 to +125	°C
TBIAS	Temperature Under Bias	-55 to +125	-65 to +135	°C
TSTG	Storage Temperature	-55 to +125	-65 to +150	°C
PT	Power Dissipation	0.5	0.5	W
IOUT	DC Output Current	-60 to +120	-60 to +120	mA

2537 Ink 03

NOTES:

- Stresses greater than those listed under ABSOLUTE MAXIMUM RATINGS may cause permanent damage to the device. This is a stress rating only and functional operation of the device at these or any other conditions above those indicated in the operational sections of this specification is not implied. Exposure to absolute maximum rating conditions for extended periods may affect reliability. No terminal voltage may exceed Vcc by +0.5V unless otherwise noted.
- Input and Vcc terminals only.
- Outputs and I/O terminals only.

CAPACITANCE (TA = +25°C, f = 1.0MHz)

Symbol	Parameter ⁽¹⁾	Conditions	Typ.	Max.	Unit
CIN	Input Capacitance	VIN = 0V	6	10	pF
COUT	Output Capacitance	VOUT = 0V	8	12	pF

2537 Ink 04

NOTE:

- This parameter is measured at characterization but not tested.

6

DC ELECTRICAL CHARACTERISTICS OVER OPERATING RANGE

Following Conditions Apply Unless Otherwise Specified:

Commercial: $T_A = 0^\circ\text{C}$ to $+70^\circ\text{C}$, $V_{CC} = 5.0\text{V} \pm 5\%$; Military: $T_A = -55^\circ\text{C}$ to $+125^\circ\text{C}$, $V_{CC} = 5.0\text{V} \pm 10\%$

Symbol	Parameter	Test Conditions ⁽¹⁾		Min.	Typ. ⁽²⁾	Max.	Unit
V_{IH}	Input HIGH Level	Guaranteed Logic HIGH Level		2.0	—	—	V
V_{IL}	Input LOW Level	Guaranteed Logic LOW Level		—	—	0.8	V
I_{IH}	Input HIGH Current ⁽⁴⁾	$V_{CC} = \text{Max.}$	$V_I = 2.7\text{V}$	—	—	± 1	μA
I_{IL}	Input LOW Current ⁽⁴⁾	$V_{CC} = \text{Max.}$	$V_I = 0.5\text{V}$	—	—	± 1	μA
I_{OZH}	High Impedance Output ⁽⁴⁾ Current	$V_{CC} = \text{Max.}$	$V_O = 2.7\text{V}$	—	—	± 1	μA
I_{OZL}			$V_O = 0.5\text{V}$	—	—	± 1	μA
I_I	Input HIGH Current ⁽⁴⁾	$V_{CC} = \text{Max.}, V_I = V_{CC} (\text{Max.})$		—	—	± 1	μA
V_{IK}	Clamp Diode Voltage	$V_{CC} = \text{Min.}, I_N = -18\text{mA}$		—	-0.7	-1.2	V
I_{OS}	Short Circuit Current	$V_{CC} = \text{Max.}^{(3)}, V_O = \text{GND}$		-60	-120	-225	mA
V_{OH}	Output HIGH Voltage	$V_{CC} = \text{Min.}$ $V_{IN} = V_{IH}$ or V_{IL}	$I_{OH} = -6\text{mA MIL.}$	2.4	3.3	—	V
			$I_{OH} = -8\text{mA COM'L.}$	—	—	—	—
			$I_{OH} = -12\text{mA MIL.}$ $I_{OH} = -15\text{mA COM'L.}$	2.0	3.0	—	V
V_{OL}	Output LOW Voltage	$V_{CC} = \text{Min.}$ $V_{IN} = V_{IH}$ or V_{IL}	$I_{OL} = 32\text{mA MIL.}$ $I_{OL} = 48\text{mA COM'L.}$	—	0.3	0.5	V
I_{OFF}	Input/Output Power Off Leakage ⁽⁵⁾	$V_{CC} = 0\text{V}, V_{IN}$ or $V_O \leq 4.5\text{V}$		—	—	± 1	μA
V_H	Input Hysteresis	—		—	200	—	mV
I_{CC}	Quiescent Power Supply Current	$V_{CC} = \text{Max.}$ $V_{IN} = \text{GND}$ or V_{CC}		—	0.01	1	mA

NOTES:

1. For conditions shown as Max. or Min., use appropriate value specified under Electrical Characteristics for the applicable device type.
2. Typical values are at $V_{CC} = 5.0\text{V}$, $+25^\circ\text{C}$ ambient.
3. Not more than one output should be shorted at one time. Duration of the short circuit test should not exceed one second.
4. The test limit for this parameter is $\pm 5\mu\text{A}$ at $T_A = -55^\circ\text{C}$.
5. This parameter is guaranteed but not tested.

2537 tbl 05

POWER SUPPLY CHARACTERISTICS

Symbol	Parameter	Test Conditions ⁽¹⁾		Min.	Typ. ⁽²⁾	Max.	Unit	
ΔI_{CC}	Quiescent Power Supply Current TTL Inputs HIGH	V _{CC} = Max. V _{IN} = 3.4V ⁽³⁾		—	0.5	2.0	mA	
I _{CCD}	Dynamic Power Supply Current ⁽⁴⁾	V _{CC} = Max. Outputs Open \bar{E} or \bar{OE} = GND One Bit Toggling 50% Duty Cycle	V _{IN} = V _{CC} V _{IN} = GND	—	0.15	0.25	mA/MHz	
I _C	Total Power Supply Current ⁽⁶⁾	V _{CC} = Max. Outputs Open f _o = 10MHz 50% Duty Cycle \bar{E} or \bar{OE} = GND One Bit Toggling	V _{IN} = V _{CC} V _{IN} = GND	—	1.5	3.5	mA	
			V _{IN} = 3.4V V _{IN} = GND	—	1.8	4.5		
			V _{IN} = V _{CC} Outputs Open f _o = 2.5MHz 50% Duty Cycle \bar{E} or \bar{OE} = GND Four Bits Toggling	V _{IN} = V _{CC} V _{IN} = GND	—	1.5		3.5 ⁽⁵⁾
				V _{IN} = 3.4V V _{IN} = GND	—	2.5		7.5 ⁽⁵⁾

NOTES:

2537 tbl 06

- For conditions shown as Max. or Min., use appropriate value specified under Electrical Characteristics for the applicable device type.
- Typical values are at V_{CC} = 5.0V, +25°C ambient.
- Per TTL driven input (V_{IN} = 3.4V); all other inputs at V_{CC} or GND.
- This parameter is not directly testable, but is derived for use in Total Power Supply calculations.
- Values for these conditions are examples of the I_{CC} formula. These limits are guaranteed but not tested.
- I_C = I_{QUIESCENT} + I_{INPUTS} + I_{DYNAMIC}
 I_{CC} = Quiescent Current
 ΔI_{CC} = Power Supply Current for a TTL High Input (V_{IN} = 3.4V)
 DH = Duty Cycle for TTL Inputs High
 N_T = Number of TTL Inputs at DH
 I_{CCD} = Dynamic Current Caused by an Output Transition Pair (HLH or LHL)
 f_o = Output Frequency
 N_o = Number of Outputs at f_o
 All currents are in milliamps and all frequencies are in megahertz.

6

SWITCHING CHARACTERISTICS OVER OPERATING RANGE – FCT157T/AT/CT/DT

Symbol	Parameter	Condition ⁽¹⁾	54/74FCT157T				54/74FCT157AT				Unit
			Com'l.		Mil.		Com'l.		Mil.		
			Min. ⁽²⁾	Max.	Min. ⁽²⁾	Max.	Min. ⁽²⁾	Max.	Min. ⁽²⁾	Max.	
tPLH tPHL	Propagation Delay IN to ZN	CL = 50pF RL = 500Ω	1.5	6.0	1.5	7.0	1.5	5.0	1.5	5.8	ns
tPLH tPHL	Propagation Delay \bar{E} to ZN		1.5	10.5	1.5	12.0	1.5	6.0	1.5	7.4	ns
tPLH tPHL	Propagation Delay S to ZN		1.5	10.5	1.5	12.0	1.5	7.0	1.5	8.1	ns

2537 tbl 07

Symbol	Parameter	Condition ⁽¹⁾	54/74FCT157CT				54/74FCT157DT				Unit
			Com'l.		Mil.		Com'l.		Mil.		
			Min. ⁽²⁾	Max.	Min. ⁽²⁾	Max.	Min. ⁽²⁾	Max.	Min. ⁽²⁾	Max.	
tPLH tPHL	Propagation Delay IN to ZN	CL = 50pF RL = 500Ω	1.5	4.3	1.5	5.0	1.5	3.9	—	—	ns
tPLH tPHL	Propagation Delay \bar{E} to ZN		1.5	4.8	1.5	5.9	1.5	4.4	—	—	ns
tPLH tPHL	Propagation Delay S to ZN		1.5	5.2	1.5	6.0	1.5	4.6	—	—	ns

2537 tbl 08

SWITCHING CHARACTERISTICS OVER OPERATING RANGE – FCT257T/AT/CT/DT

Symbol	Parameter	Condition ⁽¹⁾	54/74FCT257T				54/74FCT257AT				Unit
			Com'l.		Mil.		Com'l.		Mil.		
			Min. ⁽²⁾	Max.	Min. ⁽²⁾	Max.	Min. ⁽²⁾	Max.	Min. ⁽²⁾	Max.	
tPLH tPHL	Propagation Delay IN to ZN	CL = 50pF RL = 500Ω	1.5	6.0	1.5	7.0	1.5	5.0	1.5	5.8	ns
tPLH tPHL	Propagation Delay S to ZN		1.5	10.5	1.5	12.0	1.5	7.0	1.5	8.1	ns
tPZH tPZL	Output Enable Time		1.5	8.5	1.5	10.0	1.5	7.0	1.5	8.0	ns
tPHZ tPLZ	Output Disable Time		1.5	6.0	1.5	8.0	1.5	5.5	1.5	5.8	ns

2537 tbl 09

Symbol	Parameter	Condition ⁽¹⁾	54/74FCT257CT				54/74FCT257DT				Unit
			Com'l.		Mil.		Com'l.		Mil.		
			Min. ⁽²⁾	Max.	Min. ⁽²⁾	Max.	Min. ⁽²⁾	Max.	Min. ⁽²⁾	Max.	
tPLH tPHL	Propagation Delay IN to ZN	CL = 50pF RL = 500Ω	1.5	4.3	1.5	5.0	1.5	3.9	—	—	ns
tPLH tPHL	Propagation Delay S to ZN		1.5	5.2	1.5	6.0	1.5	4.4	—	—	ns
tPZH tPZL	Output Enable Time		1.5	6.0	1.5	6.8	1.5	4.4	—	—	ns
tPHZ tPLZ	Output Disable Time		1.5	5.0	1.5	5.3	1.5	4.4	—	—	ns

2537 tbl 10

NOTES:

1. See test circuits and waveforms.
2. Minimum limits are guaranteed but not tested on Propagation Delay.

TEST CIRCUITS AND WAVEFORMS

TEST CIRCUITS FOR ALL OUTPUTS

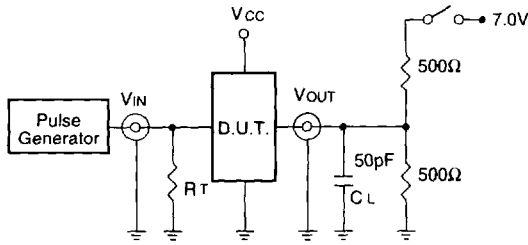

2537 drw 04

SWITCH POSITION

Test	Switch
Open Drain Disable Low Enable Low	Closed
All Other Tests	Open

DEFINITIONS:

CL = Load capacitance: includes jig and probe capacitance.
RT = Termination resistance: should be equal to Zout of the Pulse Generator.

2537 Ink 11

SET-UP, HOLD AND RELEASE TIMES

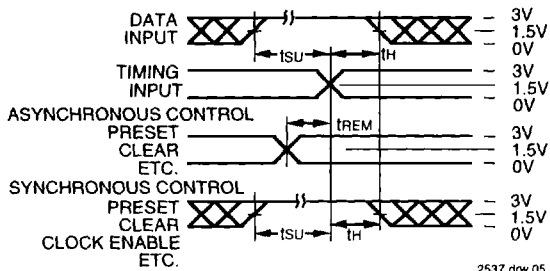

2537 drw 05

PULSE WIDTH

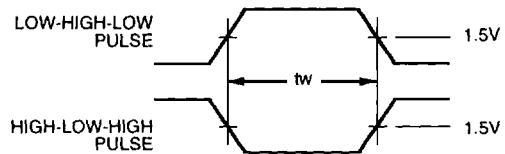

2537 drw 06



PROPAGATION DELAY

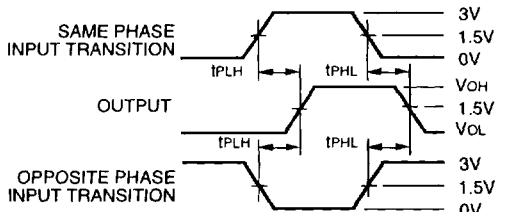

2537 drw 07

ENABLE AND DISABLE TIMES

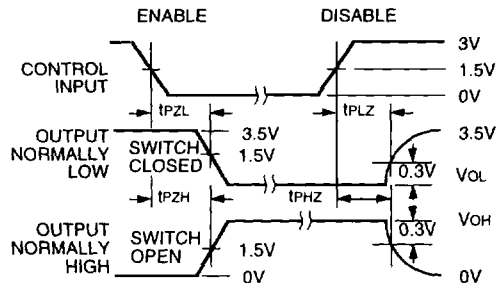

2537 drw 08

NOTES:

1. Diagram shown for input Control Enable-LOW and input Control Disable-HIGH
2. Pulse Generator for All Pulses: Rate ≤ 1.0MHz; tr ≤ 2.5ns; th ≤ 2.5ns

ORDERING INFORMATION

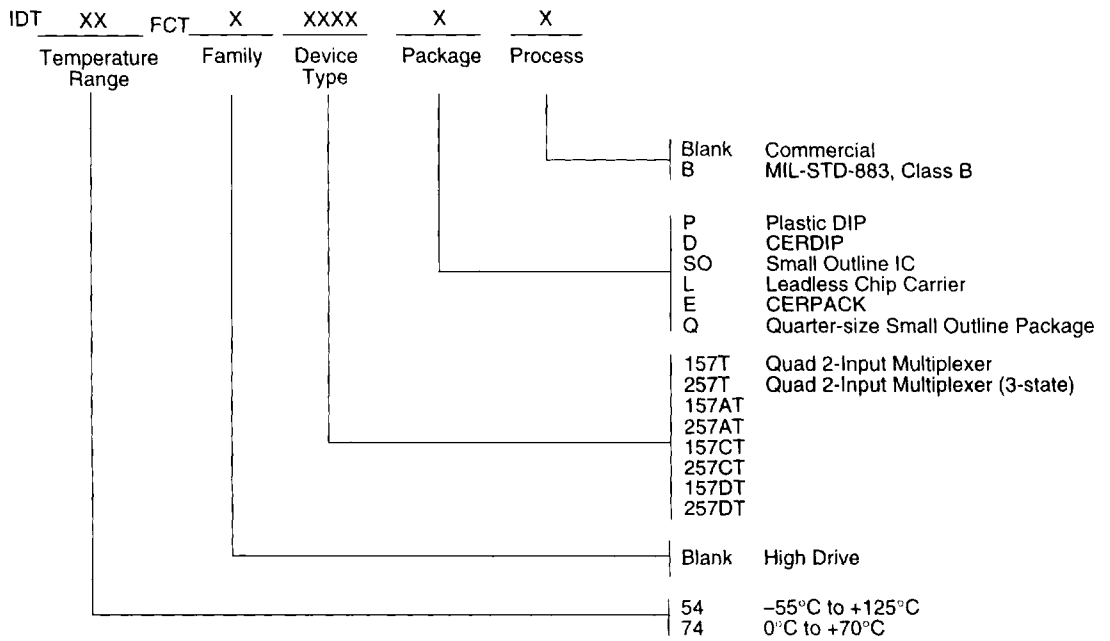

2537 drw 09