

RIGHT ANGLE, P.C.B. D-SUB ORDERING CODE

PDI - 15

S

-

9

-

J

NUMBER OF PINS
 =09
 =15
 =25
 =37

GENDER
 MALE =S
 FEMALE =R

FOOT PRINT LENGTH
 7.2mm = BLANK
 5.34mm =5
 9.4mm =9
 13.84mm =13
 9.4mm RECESSED BOARD LOCK =9L
 13.84mm RECESSED BOARD LOCK =13L





MATING FACE
 4-40 THREADED RIVET = BLANK
 JACK SCREW 4-40 THREAD =J
 RIVETED HEX STANDOFF =K
 4-40 THREADED RIVET & JACK SCREW (UNASSEMBLED) =P
 4-40 THREADED RIVET & JACK SCREW =R

P.C.B. FACE
 BOARD LOCK = BLANK
 HOLE =H
 THREADED HOLE =T
 NO GROUNDING STRAP =Z

GOLD PLATING (XX IS GOLD IN MICRO INCHES) =GXX
 GOLD FLASH (STANDARD) = BLANK

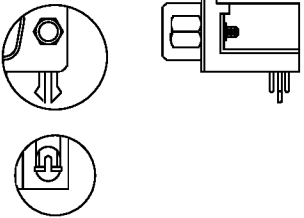
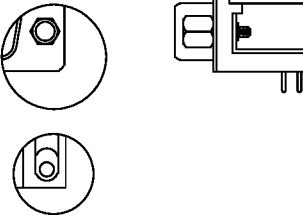
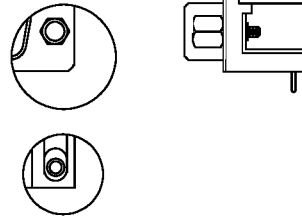
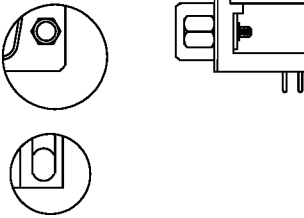
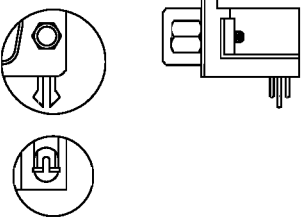
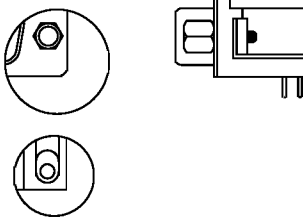
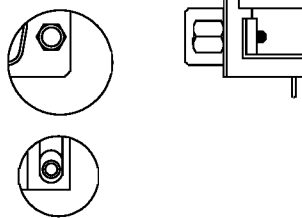
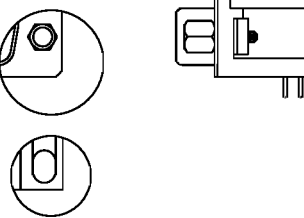
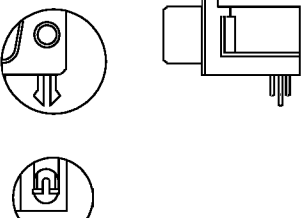
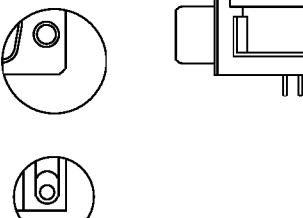
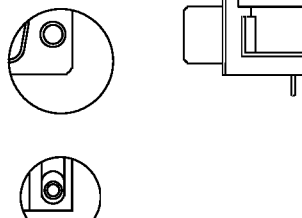
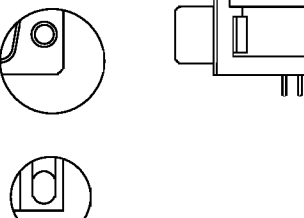
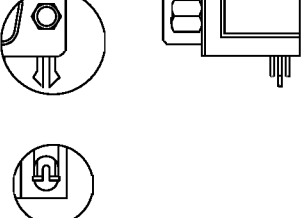
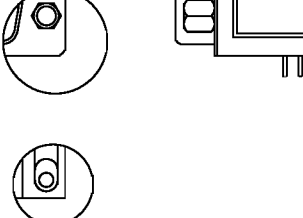
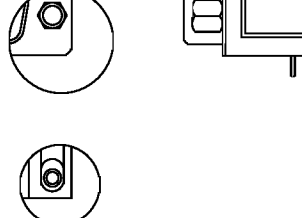
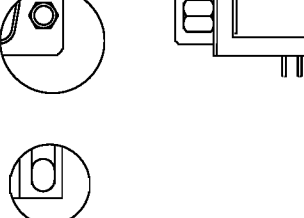
BOARD MOUNT OPTIONS, RIGHT ANGLE D-SUB P.C.B. FACE OPTIONS

MATING FACE OPTIONS

	STANDARD BOARD LOCK	H OPTION HOLE	T OPTION THREADED HOLE	Z OPTION NO GROUNDING STRAP
J OPTION				
JACK SCREW 4-40 THREAD				
R OPTION ASSEMBLED				
4-40 THREADED RIVET AND JACK SCREW				
P OPTION UNASSEMBLED				
STANDARD				
4-40 THREADED RIVET				
K OPTION				
RIVETED HEX STANDOFF				

6

5

4

3

2

1

MATERIAL AND FINISH

Shell: Steel, Tin plated.

Pin contact: Brass, Gold plating over Nickel

Insulator: PBT & glass filled reinforced, UL

94V-0 rated.

ELECTRICAL SPECIFICATIONS:

Rated current: 3A

Rated voltage: 250VDC

Insulation resistance: 1000 Mohm min @

500VDC

Dielectric withstanding voltage: 1000VAC for one minute.

Contact resistance: 15 mohm max.

ENVIRONMENTAL:

Operating temperature: -55°C to +105°C

NOTE: Replace first XX in part number with number of positions.

POSITIONS	A	B	C
09	16.9	25.0	30.8
15	25.3	33.3	39.2
25	39.0	47.1	53.1
37	55.2	63.5	69.4

Top view of the connector showing dimensions A, B, C, 2.77, 2.84, 8.3, 12.5, and 2X UNC #4-40.

Side view of the connector showing dimensions 6.0, 3.2, 2.84, 8.1, and 9.52.

ENVIRONMENTAL:

Operating temperature: -55°C to +105°C

NOTE: Replace first XX in part number with number of positions.

Bottom view of the connector showing dimensions 18.4 and 8.1.

RECOMMENDED PCB LAYOUT (TOP VIEW) showing dimensions B, 2.77, 1.385, 2XØ3.2, 2.84, 8.1, and PCB EDGE.

RECOMMENDED
PCB LAYOUT (TOP VIEW)

-XXX: SEE ORDERING CODE FOR OPTIONS

TOLERANCE
UNLESS OTHERWISE SPECIFIED

X	± 1
X.X	± 0.4
X.XX	± 0.13

Power Dynamics, Inc.

Phone: 973 560-0019 Whippany, New Jersey Fax: 973 560-0076

PART: RIGHT ANGLE, MALE D-SUB

P.C.B. MOUNT, 8.1mm FOOTPRINT

DRAWN BY	DF	DATE:	2/6/06
CHECK BY		DATE:	
APPR BY		DATE:	

PART #: PDI-XXS-XXX

SHEET
1 of 1SIZE: A
SCALE: NTSALL DIMENSIONS FOR REFERENCE ONLY
DIMENSIONS ARE IN MILLIMETERS

REV:

6

5

4

3

2

1

REV	DATE	CHANGE	CHK	CHK	APPR

6

5

4

3

2

1

MATERIAL AND FINISH

Shell: Steel, Nickel plated.
Pin contact: Brass, Gold plating over Nickel.
Insulator: PBT & glass fiber reinforced, UL 94V-0 rated.

ELECTRICAL SPECIFICATIONS:

Rated current: 5A
Insulation resistance: 1000 Mohm min @ 500VDC
Dielectric withstanding voltage: 1000VAC for one minute.
Contact resistance: 15 mohm max. 10 sec.

ENVIRONMENTAL:

Operating temperature: -55°C to +105°C

NOTE: Replace first XX in part number with number of positions.

POSITIONS	A	B	C
09	16.3	25.0	30.8
15	24.6	33.3	39.2
25	38.3	47.1	53.1
37	54.8	63.5	69.4

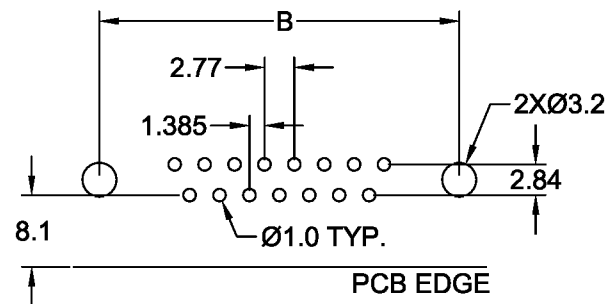
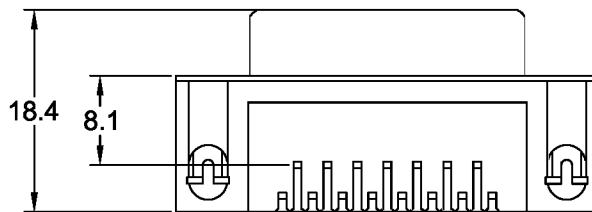
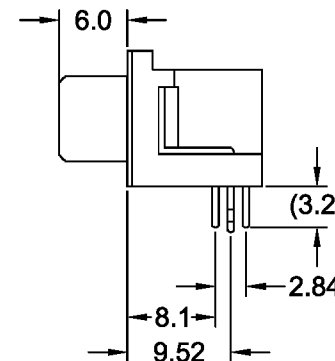
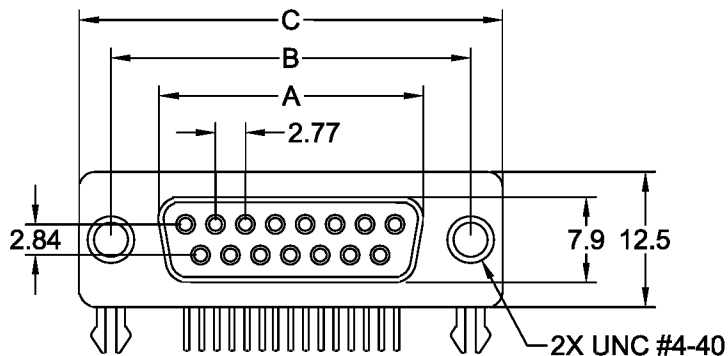

RECOMMENDED PCB LAYOUT (TOP VIEW)

-XXX: SEE ORDERING CODE FOR OPTIONS

TOLERANCE UNLESS OTHERWISE SPECIFIED	
X	± 1
X.X	± 0.4
X.XX	± 0.13

DRAWN BY	DF	DATE:	2/6/06
CHECK BY		DATE:	
APPR BY		DATE:	

Power Dynamics, Inc.
 Phone: 973 560-0019 Whippany, New Jersey Fax: 973 560-0076
 PART: RIGHT ANGLE, FEMALE D-SUB
 P.C.B. MOUNT, 8.1mm FOOTPRINT
PDI-XXR-XXX
 SHEET 1 of 1
 ALL DIMENSIONS FOR REFERENCE ONLY
 DIMENSIONS ARE IN MILLIMETERS
 REV:

REV	DATE	CHANGE	CHKG	CHKD	APPR

6

5

4

3

2

1

MATERIAL AND FINISH

Shell: Steel, Nickel plated.
 Pin contact: Brass, Gold plating over Nickel.
 Insulator: PBT & glass fiber reinforced, UL 94V-0 rated.

ELECTRICAL SPECIFICATIONS:

Rated current: 5A
 Insulation resistance: 1000 Mohm min @ 500VDC
 Dielectric withstanding voltage: 1000VAC for one minute.
 Contact resistance: 15 mohm max. 10 sec.

ENVIRONMENTAL:

Operating temperature: -55°C to +105°C

NOTE: Replace first XX in part number with number of positions.

POSITIONS	A	B	C
09	16.3	25.0	30.8
15	24.6	33.3	39.2
25	38.3	47.1	53.1
37	54.8	63.5	69.4

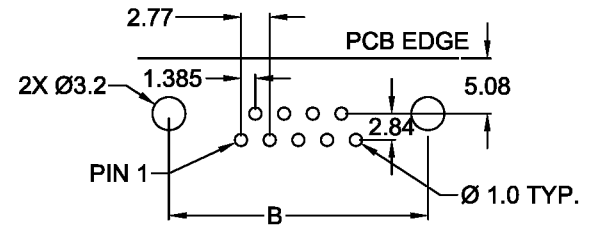
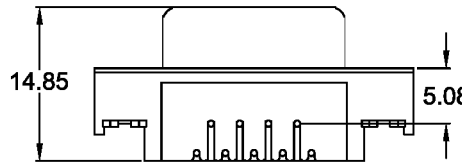
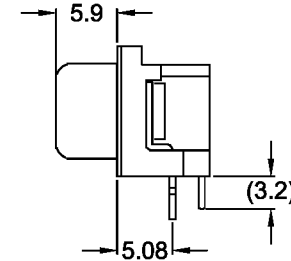
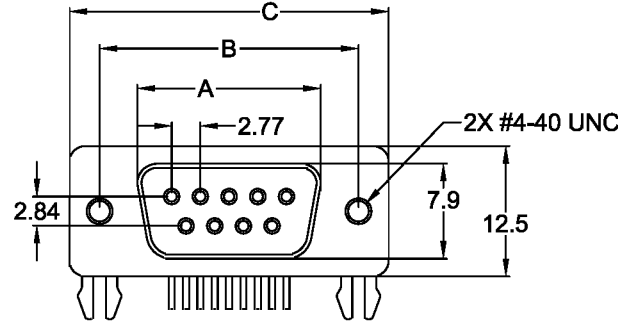

RECOMMENDED PCB LAYOUT (TOP VIEW)

-XXX: SEE ORDERING CODE FOR OPTIONS

TOLERANCE UNLESS OTHERWISE SPECIFIED	
X	± 1
X.X	± 0.4
X.XX	± 0.20

DRAWN BY	DF	DATE:	2/3/06
CHECK BY		DATE:	
APPR BY		DATE:	

Power Dynamics, Inc.
 Phone: 973 560-0019 Whippany, New Jersey Fax: 973 560-0076

PART: RIGHT ANGLE, FEMALE D-SUB
 P.C.B. MOUNT, 5.08mm FOOTPRINT

PART #: **PDI-XXR-5-XXX** SHEET 1 of 1

SIZE: **A** ALL DIMENSIONS FOR REFERENCE ONLY
 SCALE: **NTS** DIMENSIONS ARE IN MILLIMETERS

REV	DATE	CHANGE	CHK	CHK	APPR

MATERIAL AND FINISH

Shell: Steel, Tin plated.
 Pin contact: Brass, Gold plating over Nickel
 Insulator: PBT & glass filled reinforced, UL 94V-0 rated.

ELECTRICAL SPECIFICATIONS:

Rated current: 3A
 Rated voltage: 250VDC
 Insulation resistance: 1000 Mohm min @ 500VDC
 Dielectric withstanding voltage: 1000VAC for one minute.
 Contact resistance: 15 mohm max.

ENVIRONMENTAL:

Operating temperature: -55°C to +105°C

NOTE: Replace first XX in part number with number of positions.

POSITIONS	A	B	C
09	16.9	25.0	30.8
15	25.3	33.3	39.2
25	39.0	47.1	53.1
37	55.2	63.5	69.4

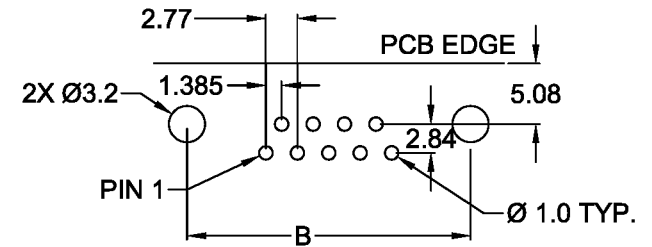
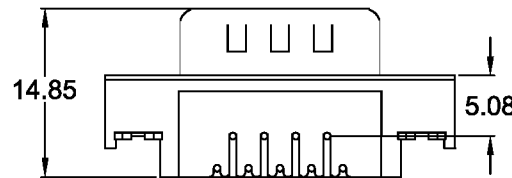
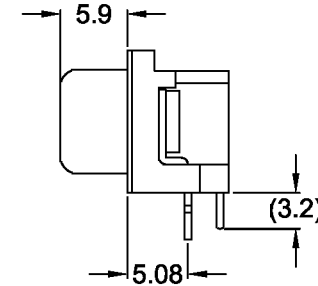
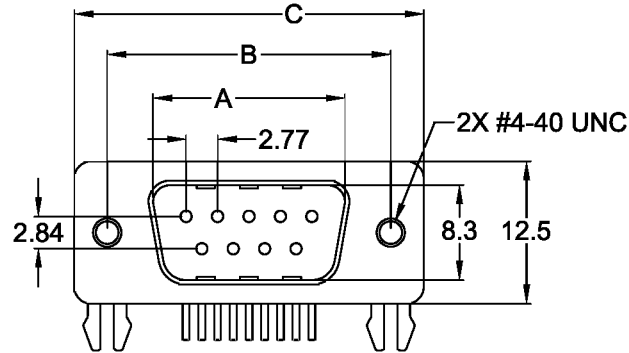

-XXX: SEE ORDERING CODE FOR OPTIONS

TOLERANCE
 UNLESS OTHERWISE SPECIFIED

X ± 1
 X.X ± 0.4
 X.XX ± 0.20

Power Dynamics, Inc.

Phone: 973 560-0019 Whippany, New Jersey Fax: 973 560-0076

PART: RIGHT ANGLE, MALE D-SUB
 P.C.B. MOUNT, 5.08mm FOOT PRINT

DRAWN BY	DF	DATE:	2/6/06
CHECK BY		DATE:	
APPR BY		DATE:	

PART #:	PDI-XXS-5-XXX	SHEET	1 of 1
SIZE:	A	ALL DIMENSIONS FOR REFERENCE ONLY DIMENSIONS ARE IN MILLIMETERS	
SCALE:	NTS	REV:	

REVISIONS	CHNG	CHK	APPR
REV	DATE	CHANGE	

6

5

4

3

2

1

MATERIAL AND FINISH

Shell: Steel, Nickel plated.

Pin contact: Brass, Gold plating over Nickel.

Insulator: PBT & glass fiber reinforced, UL 94V-0 rated.

ELECTRICAL SPECIFICATIONS:

Rated current: 5A

Insulation resistance: 1000 Mohm min @ 500VDC

Dielectric withstanding voltage: 1000VAC for one minute.

Contact resistance: 15 mohm max. 10 sec.

ENVIRONMENTAL:

Operating temperature: -55°C to +105°C

NOTE: Replace first XX in part number with number of positions.

POSITION	A	B	C
09	16.3	25.0	30.8
15	24.6	33.3	39.2
25	38.3	47.1	53.1
37	54.8	63.5	69.4

Dimensions: A, B, C, 2.84, 7.9, 12.5, 2X UNC #4-40, 2.77

Dimensions: 6.0, 10.3, (3.2)

Dimension: 10.3

Dimensions: B, 2.77, 1.385, 2.84, 2X Ø3.2, Ø1.0 TYP., PCB EDGE

RECOMMENDED PCB LAYOUT (TOP VIEW)

-XXX: SEE ORDERING CODE FOR OPTIONS

TOLERANCE

UNLESS OTHERWISE SPECIFIED

X ± 1
X.X ± 0.4
X.XX ± 0.20

Power Dynamics, Inc.

Phone: 973 560-0019 Whippany, New Jersey Fax: 973 560-0076

PART: RIGHT ANGLE, FEMALE D-SUB
P.C.B. MOUNT, 10.3mm FOOTPRINT

DRAWN BY	DF	DATE:	2/6/06
CHECK BY		DATE:	
APPR BY		DATE:	

PART #: **PDI-XXR-9-XXX**

SHEET
1 of 1

SIZE: A
SCALE: NTS
ALL DIMENSIONS FOR REFERENCE ONLY
DIMENSIONS ARE IN MILLIMETERS

REV:

6

5

4

3

2

1

REV	DATE	CHANGE	CHK	CHK	APPR

D

D

C

C

B

B

A

A

6

5

4

3

2

1

MATERIAL AND FINISH

Insulator: PBT, UL 94V-0 rated.

Shell: Steel, Tin plated.

Pin contact: Brass, Gold plating over Nickel in contact area, Tin on tails.

POSITION	A	B	C
09	16.9	25.0	30.8
15	25.3	33.3	39.2
25	39.0	47.1	53.1
37	55.2	63.5	69.4

ELECTRICAL SPECIFICATIONS:

Rated current: 3A

Rated voltage: 250VDC

Insulation resistance: 3000 Mohm min @ 500VDC

Dielectric withstanding voltage: 1000VAC / 1 minute.

Contact resistance: 15 mohm

ENVIRONMENTAL:

Operating temperature: -55°C to +105°C

NOTE: Replace first XX in part number with the number of positions.

Top view of the connector showing dimensions A, B, C, 2.84, 12.5, 8.3, and 2X UNC #4-40.

Side view of the connector showing dimensions 6.0, 10.3, and (3.2).

ENVIRONMENTAL:

Operating temperature: -55°C to +105°C

NOTE: Replace first XX in part number with the number of positions.

Bottom view of the connector showing dimensions 10.3 and 2.77.

RECOMMENDED PCB LAYOUT (TOP VIEW) showing dimensions B, 1.385, 2.77, 2.84, 10.3, Ø1.0 TYP., and 2X Ø3.2.

RECOMMENDED PCB LAYOUT (TOP VIEW)

-XXX: SEE ORDERING CODE FOR OPTIONS

TOLERANCE
UNLESS OTHERWISE SPECIFIED

X	± 1
X.X	± 0.4
X.XX	± 0.20

Power Dynamics, Inc.

Phone: 973 560-0019 Whippany, New Jersey Fax: 973 560-0076

PART: RIGHT ANGLE, MALE D-SUB

P.C.B. MOUNT, 10.3mm FOOTPRINT

DRAWN BY	DF	DATE:	2/8/06
CHECK BY		DATE:	
APPR BY		DATE:	

PART #: PDI-XXS-9-XXX

SHEET
1 of 1SIZE: A
SCALE: NTSALL DIMENSIONS FOR REFERENCE ONLY
DIMENSIONS ARE IN MILLIMETERS

REV:

REVISIONS

CHANGE

REV DATE

CHNGCHK APPR

6

5

4

3

2

1

6

5

4

3

2

1

MATERIAL AND FINISH

Insulator: PBT, UL 94V-0 rated.

Shell: Steel, Tin plated.

Pin contact: Brass, Gold Plating in contact area, Tin on tails over Nickel.

POSITION	A	B	C
09	16.3	25.0	30.8
15	24.6	33.3	39.2
25	38.3	47.1	53.1
37	54.8	63.5	69.4

ELECTRICAL SPECIFICATIONS:

Rated current: 3A max.

Rated voltage: 250VAC max.

Insulation resistance: 3000 Mohm min. @ 500VDC

Dielectric withstanding voltage: 1000VAC / 1 minute.

Contact resistance: 15 mohm max.

ENVIRONMENTAL:

Operating temperature: -55°C to +105°C

NOTES: Replace first XX in P/N with number of positions.

RECOMMENDED
PCB LAYOUT (TOP VIEW)

-XXX: SEE ORDERING CODE FOR OPTIONS

TOLERANCE

UNLESS OTHERWISE SPECIFIED

X	±	1
X.X	±	0.4
X.XX	±	0.20

Power Dynamics, Inc.

Phone: 973 560-0019 Whippany, New Jersey Fax: 973 560-0076

PART: RIGHT ANGLE, FEMALE D-SUB
PCB MOUNT, 14.96mm FOOTPRINT

DRAWN BY	DF	DATE:	2/8/06
CHECK BY		DATE:	
APPR BY		DATE:	

PART #: PDI-XXR-13-XXX

SHEET
1 of 1SIZE: A
SCALE: NTSALL DIMENSIONS FOR REFERENCE ONLY
DIMENSIONS ARE IN MILLIMETERS

REV:

6

5

4

3

2

1

REV	DATE	CHANGE	CHK	CHK	APPR

6

5

4

3

2

1

MATERIAL AND FINISH

Insulator: PBT, UL 94V-0 rated.

Shell: Steel, Tin plated.

Pin contact: Brass, Gold Plating in contact area, Tin on tails over Nickel.

POSITION	A	B	C
09	16.9	25.0	30.8
15	25.3	33.3	39.2
25	39.0	47.1	53.1
37	55.2	63.5	69.4

ELECTRICAL SPECIFICATIONS:

Rated current: 3A max.

Rated voltage: 250VAC max.

Insulation resistance: 3000 Mohm min. @ 500VDC

Dielectric withstanding voltage: 1000VAC / 1 minute.

Contact resistance: 15 mohm max.

ENVIRONMENTAL:

Operating temperature: -55°C to +105°C

NOTES: Replace first XX in P/N with number of positions.

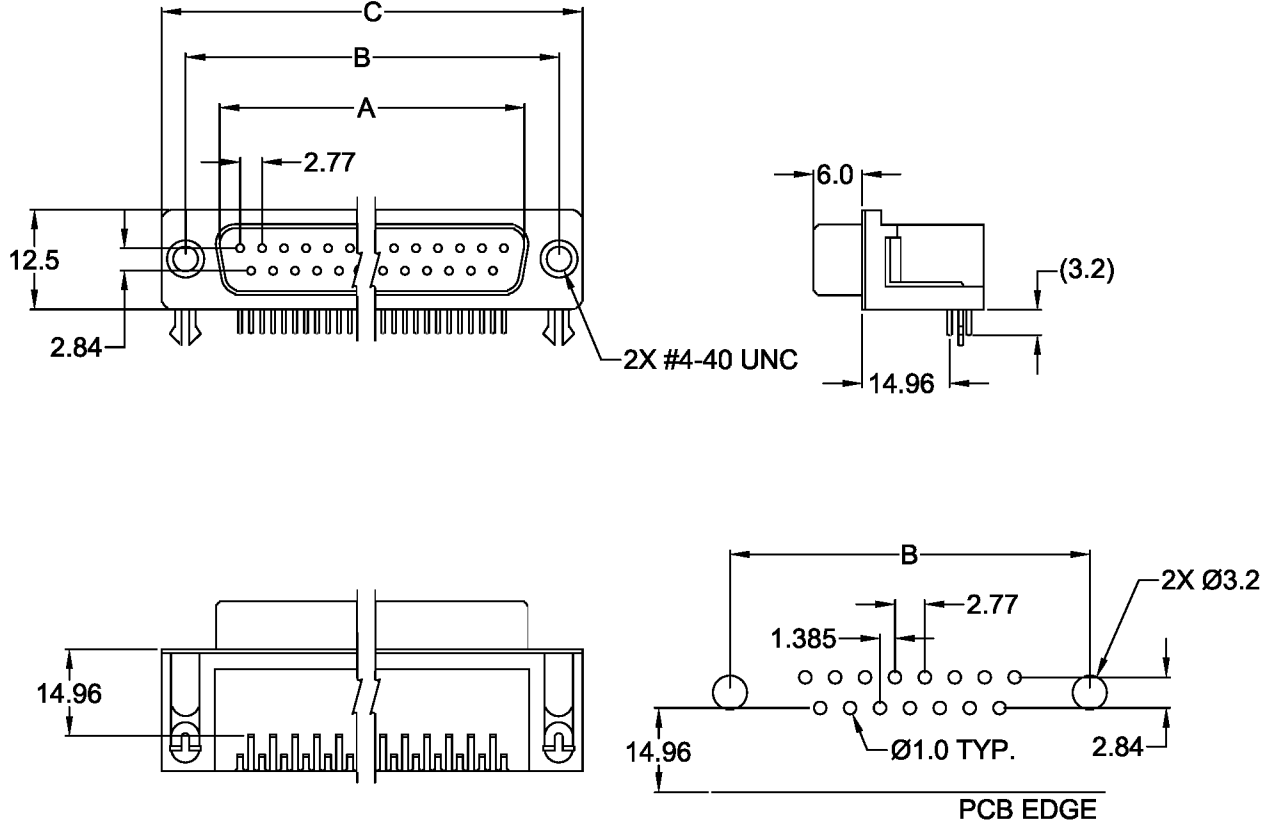

RECOMMENDED
PCB LAYOUT (TOP VIEW)

-XXX: SEE ORDERING CODE FOR OPTIONS

TOLERANCE UNLESS OTHERWISE SPECIFIED	
X	± 1
X.X	± 0.4
X.XX	± 0.20
DRAWN BY	DF
CHECK BY	DATE: 2/8/06
APPR BY	DATE:

Power Dynamics, Inc.
 Phone: 973 560-0019 Whippany, New Jersey Fax: 973 560-0076

PART: RIGHT ANGLE, MALE D-SUB
 PCB MOUNT, 14.96mm FOOTPRINT

PART #: **PDI-XXS-13-XXX** SHEET 1 of 1

SIZE: A ALL DIMENSIONS FOR REFERENCE ONLY
 SCALE: NTS DIMENSIONS ARE IN MILLIMETERS REV:

REVISIONS	CHANGE	CHK	CHK	APPR
REV	DATE			

6

5

4

3

2

1