

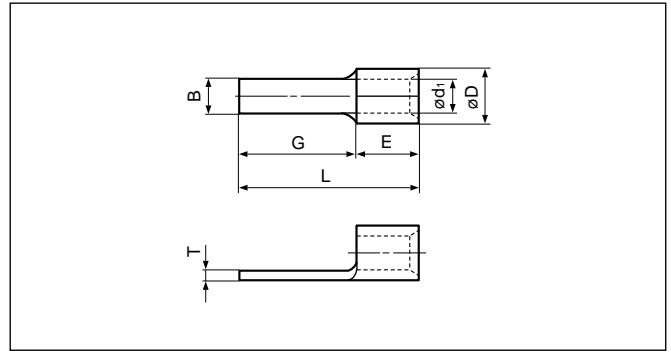

















Solderless terminals

**BLADE** Non-insulated



File No.:  E42024

Applicable Wire AWG#(mm <sup>2</sup> )	Part No.	Standard	Dimensions mm (in.)							Tool No.					Qty/box
			B	L	G	E	øD	ød <sub>1</sub>	T	YHT-2210	YA-1	YA-2	YA-4	BCT-0514	
22 to 16 (0.25 to 1.65)	1.25-1AF		2.8 (.110)	13.3 (.524)	9.0 (.354)	4.3 (.169)	3.4 (.134)	1.7 (.067)	0.8 (.031)	0	0	0	0	0	1,000
	1.25-2AF		3.4 (.134)	15.0 (.591)	10.2 (.402)	4.8 (.189)									
	1.25-3AF		1.0 (.039)	14.0 (.551)	9.8 (.386)	4.2 (.165)									
	1.25-AF2.3A		2.3 (.091)	23.0 (.906)	18.0 (.709)	4.8 (.189)									
	1.25-AF2.3B		2.3 (.091)	15.0 (.591)	10.0 (.394)	4.8 (.189)									
	1.25-AF3A-S		3.0 (.118)	17.3 (.681)	12.5 (.492)	4.8 (.189)									
	1.25-BL		3.0 (.118)	15.9 (.626)	11.1 (.437)	4.8 (.189)									
	1.25-BL2		3.0 (.118)	19.3 (.760)	14.5 (.571)	4.8 (.189)									
1.25-BLA		3.0 (.118)	15.9 (.626)	11.1 (.437)	4.8 (.189)										
16 to 14 (1.04 to 2.63)	2-1AF		2.8 (.110)	13.3 (.524)	9.0 (.354)	4.3 (.169)	4.1 (.161)	2.3 (.091)	0.8 (.031)	0	0	0	0	0	1,000
	2-2AF G-16		2.8 (.110)	20.8 (.819)	16.0 (.630)	4.8 (.189)									
	2-AFW		4.6 (.181)	23.0 (.906)	18.2 (.717)	4.8 (.189)									
	2-AF2.3A		2.3 (.091)	23.0 (.906)	18.0 (.709)	4.8 (.189)									
	2-AF3A-S		3.0 (.118)	17.3 (.681)	12.5 (.492)	4.8 (.189)									
12 to 10 (2.63 to 6.64)	5.5-1AF		2.8 (.110)	16.2 (.638)	10.0 (.394)	6.2 (.244)	5.6 (.220)	3.4 (.134)	1.0 (.039)	0	0	0	0	0	1,000
	5.5-2AF		4.0 (.157)	25.4 (1.000)	18.6 (.732)	6.8 (.268)									
	5.5-AFW		4.5 (.177)	25.4 (1.000)	18.6 (.732)	6.8 (.268)									
	5.5-AF4A-S		4.0 (.157)	20.8 (.819)	14.0 (.551)	6.8 (.268)									

Note: 1) Terminals with part number suffix "-S" have serrations on the blade.

2) The part numbers indicated in the above table are for products with a brazed seam.

When ordering products with a butted seam, add the prefix "WS" to the part number (ex. 2-1AF → **WS2-1AF**).

3) Delivery lead times may vary depending on the product. Contact JST for details.

Solderless terminals

**BLADE** Vinyl-insulated

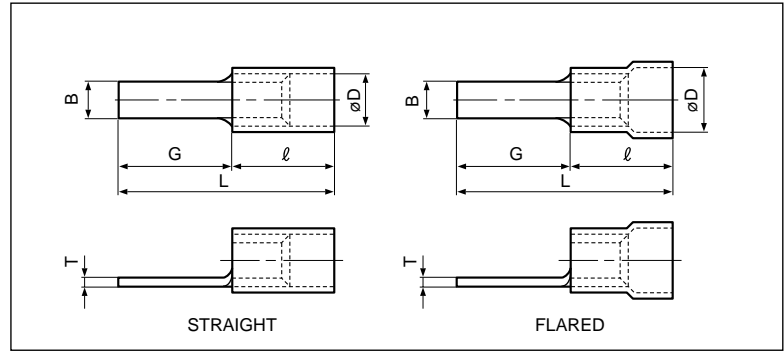
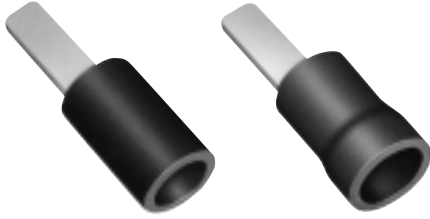

File No.: E42024

Applicable Wire AWG#(mm <sup>2</sup> )	Part No.		Standard	Dimensions mm (in.)							Color	Tool No.						Qty/box	
	Straight	Flared		B	L	G	l	ø D		T		YNT-2216	YNT-1614	YNT-1210S	YA-1	YA-2	YA-4		BCT-0514
								Str.	Fld.										
22 to 16 *(0.25 to 1.65)	V1.25-1AF	FV1.25-1AF		2.8 (.110)	18.0 (.709)	9.0 (.354)	9.0 (.354)	3.2 (.126)	4.0 (.157)	0.8 (.031)	Red	o	o	o	o	o	o	1,000	
	V1.25-2AF	FV1.25-2AF		3.4 (.134)	19.2 (.756)	10.2 (.402)													
	V1.25-3AF	FV1.25-3AF		1.0 (.039)	18.8 (.740)	9.8 (.386)													
	V1.25-AF2.3A	FV1.25-AF2.3A		2.3 (.091)	27.2 (1.071)	18.0 (.709)													
	V1.25-AF2.3B	FV1.25-AF2.3B		2.3 (.091)	19.2 (.756)	10.0 (.394)													
	V1.25-AF3A-S	FV1.25-AF3A-S		3.0 (.118)	21.5 (.846)	12.5 (.492)													
	V1.25-BL	FV1.25-BL		3.0 (.118)	20.1 (.791)	11.1 (.437)													
	V1.25-BL2	FV1.25-BL2		3.0 (.118)	23.5 (.925)	14.5 (.571)													
V1.25-BLA	FV1.25-BLA		3.0 (.118)	20.1 (.791)	11.1 (.437)														
16 to 14 (1.04 to 2.63)	V2-1AF	FV2-1AF		2.8 (.110)	18.0 (.709)	9.0 (.354)	9.0 (.354)	3.9 (.154)	4.5 (.177)	0.8 (.031)	Blue	o	o	o	o	o	o	1,000	
	V2-2AF G-16	FV2-2AF G-16		2.8 (.110)	25.0 (.984)	16.0 (.630)													
	V2-AFW	FV2-AFW		4.6 (.181)	27.2 (1.071)	18.2 (.717)													
	V2-AF2.3A	FV2-AF2.3A		2.3 (.091)	27.2 (1.071)	18.0 (.709)													
	V2-AF3A-S	FV2-AF3A-S		3.0 (.118)	21.5 (.846)	12.5 (.492)													
12 to 10 (2.63 to 6.64)	V5.5-1AF	FV5.5-1AF		2.8 (.110)	23.5 (.925)	10.0 (.394)	13.5 (.531)	5.4 (.213)	6.8 (.268)	1.0 (.039)	Yellow	o	o	o	o	o	500		
	V5.5-AFW	FV5.5-AFW		4.5 (.177)	32.1 (1.264)	18.6 (.732)													
	V5.5-AF4A-S	FV5.5-AF4A-S		4.0 (.157)	27.5 (1.083)	14.0 (.551)													







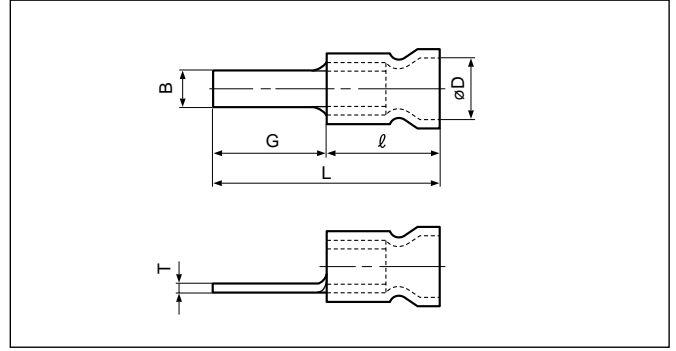







- Note: 1) Terminals with part number suffix "-S" have serrations on the blade.  
 2) The part numbers indicated in the above table are for products with a brazed seam.  
 When ordering products with a butted seam, add the prefix "WS" to the part number (ex. V2-1AF → **VWS2-1AF**).  
 3) \*The crimping will be more secure if the total cross-sectional area of the wire is at least 0.5 mm<sup>2</sup>.  
 Examples: If the cross-sectional area of the wire is 0.3mm<sup>2</sup>, fold the wire in two when crimping the terminal.  
 If the cross-sectional area of the wire is 0.5mm<sup>2</sup>, crimp the terminal onto the wire as it is.  
 4) Delivery lead times may vary depending on the product. Contact JST for details.

Solderless terminals

**BLADE** Vinyl-insulated (funnel-entry)



File No.:  E42024

Applicable Wire AWG#(mm <sup>2</sup> )	Part No.	Standard	Dimensions mm (in.)						Color	Tool No.						Qty/box
			B	L	G	ℓ	øD	T		YNT-2216	YNT-1614	YNT-1210S	YA-1	YA-2	YA-4	
22 to 16 (0.25 to 1.65)	FVX1.25-1AF		2.8 (.110)	19.8 (.780)	9.0 (.354)	10.8 (.425)	4.0 (.157)	0.8 (.031)	Red	0	0	0	0	0	0	1,000
	FVX1.25-2AF		3.4 (.134)	21.0 (.827)	10.2 (.402)											
	FVX1.25-AF2.3A		2.3 (.091)	29.0 (1.142)	18.0 (.709)											
	FVX1.25-AF2.3B		2.3 (.091)	21.0 (.827)	10.0 (.394)											
	FVX1.25-AF3A-S		3.0 (.118)	23.3 (.917)	12.5 (.492)											
	FVX1.25-BL		3.0 (.118)	21.9 (.862)	11.1 (.437)											
	FVX1.25-BL2		3.0 (.118)	25.3 (.996)	14.5 (.571)											
	FVX1.25-BLA		3.0 (.118)	21.9 (.862)	11.1 (.437)											
16 to 14 (1.04 to 2.63)	FVX2-1AF		2.8 (.110)	19.8 (.780)	9.0 (.354)	10.8 (.425)	4.6 (.181)	0.8 (.031)	Blue	0	0	0	0	0	1,000	
	FVX2-2AF G-16		2.8 (.110)	26.8 (1.005)	16.0 (.630)											
	FVX2-AFW		4.6 (.181)	29.0 (1.142)	18.2 (.717)											
	FVX2-AF2.3A		2.3 (.091)	29.0 (1.142)	18.0 (.709)											
	FVX2-AF3A-S		3.0 (.118)	23.3 (.917)	12.5 (.492)											
12 to 10 (2.63 to 6.64)	FVX5.5-AFW		4.5 (.177)	32.6 (1.283)	18.6 (.732)	14.0 (.551)	6.8 (.268)	1.0 (.039)	Yellow	0	0	0	0	500		
	FVX5.5-AF4A-S		4.0 (.157)	28.0 (1.102)	14.0 (.551)											

- Note: 1) Terminals with part number suffix "-S" have serrations on the blade.  
 2) The part numbers indicated in the above table are for products with a brazed seam.  
 When ordering products with a butted seam, add the prefix "WS" to the part number (ex. FVX2-1AF → FVXWS2-1AF).  
 3) \*The crimping will be more secure if the total cross-sectional area of the wire is at least 0.5 mm<sup>2</sup>.  
 Examples: If the cross-sectional area of the wire is 0.3mm<sup>2</sup>, fold the wire in two when crimping the terminal.  
 If the cross-sectional area of the wire is 0.5mm<sup>2</sup>, crimp the terminal onto the wire as it is.  
 4) Delivery lead times may vary depending on the product. Contact JST for details.

Solderless terminals

**BLADE** Vinyl-insulated with copper sleeve

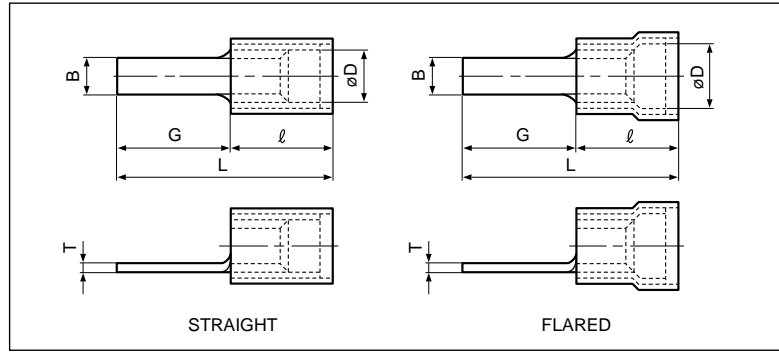
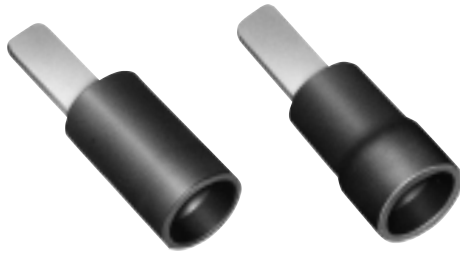

File No.: E42024

Applicable Wire AWG# (mm <sup>2</sup> )	Part No.		Standard	Dimensions mm (in.)							Color	Tool No.						Qty/box	
	Straight	Flared		B	L	G	l	ø D		T		YNT-2216	YNT-1614	YNT-1210S	YA-1	YA-2	YA-4		BCT-0514
								Str.	Fld.										
22 to 16 (0.25 to 1.65)	VD1.25-1AF	FVD1.25-1AF		2.8 (.110)	18.6 (.732)	9.0 (.354)	9.6 (.378)	3.5 (.138)	4.0 (.157)	0.8 (.031)	Red	0	0	0	0	0	0	1,000	
	VD1.25-2AF	FVD1.25-2AF		3.4 (.134)	19.8 (.780)	10.2 (.402)													
	VD1.25-3AF	FVD1.25-3AF		1.0 (.039)	19.4 (.764)	9.8 (.386)													
	VD1.25-AF2.3A	FVD1.25-AF2.3A		2.3 (.091)	27.3 (1.075)	18.0 (.709)													
	VD1.25-AF2.3B	FVD1.25-AF2.3B		2.3 (.091)	19.8 (.780)	10.0 (.394)													
	VD1.25-AF3A-S	FVD1.25-AF3A-S		3.0 (.118)	22.1 (.870)	12.5 (.492)													
	VD1.25-BL	FVD1.25-BL		3.0 (.118)	20.7 (.815)	11.1 (.437)													
	VD1.25-BL2	FVD1.25-BL2		3.0 (.118)	24.1 (.949)	14.5 (.571)													
	VD1.25-BLA	FVD1.25-BLA		3.0 (.118)	20.7 (.815)	11.1 (.437)													
16 to 14 (1.04 to 2.63)	VD2-1AF	FVD2-1AF		2.8 (.110)	18.1 (.713)	9.0 (.354)	9.6 (.378)	4.1 (.161)	4.7 (.185)	0.8 (.031)	Blue	0	0	0	0	0	0	1,000	
	VD2-2AF G-16	FVD2-2AF G-16		2.8 (.110)	25.6 (1.008)	16.0 (.630)													
	VD2-AFW	FVD2-AFW		4.6 (.181)	27.8 (1.094)	18.2 (.717)													
	VD2-AF2.3A	FVD2-AF2.3A		2.3 (.091)	27.8 (1.094)	18.0 (.709)													
	VD2-AF3A-S	FVD2-AF3A-S		3.0 (.118)	22.1 (.870)	12.5 (.492)													
12 to 10 (2.63 to 6.64)	VD5.5-1AF	FVD5.5-1AF		2.8 (.110)	24.0 (.945)	10.0 (.394)	14.0 (.551)	5.7 (.224)	6.5 (.256)	1.0 (.039)	Yellow	0	0	0	0	0	500		
	VD5.5-AFW	FVD5.5-AFW		4.5 (.177)	32.6 (1.283)	18.6 (.732)													
	VD5.5-AF4A-S	FVD5.5-AF4A-S		4.0 (.157)	28.0 (1.102)	14.0 (.551)													

- Note: 1) Terminals with part number suffix "-S" have serrations on the blade.  
 2) The part numbers indicated in the above table are for products with a brazed seam.  
 When ordering products with a butted seam, add the prefix "WS" to the part number (ex. FVD2-1AF → **FVDWS2-1AF**).  
 3) Delivery lead times may vary depending on the product. Contact JST for details.