

**PLEASE CHECK WWW.MOLEX.COM FOR LATEST PART INFORMATION**

**Part Number:** [0918143118](#)

**Status:** **Active**

**Overview:**

**Description:** 2.54mm (.100") Pitch C-Grid III™ Dual Row Right Angle Shrouded Header, 18 Circuits, Tin (Sn) over Nickel (Ni)

**Documents:**

[3D Model](#)

[Drawing \(PDF\)](#)

[RoHS Certificate of Compliance \(PDF\)](#)

**General**

Product Family	PCB Headers
Series	<a href="#">91814</a>
Application	Wire-to-Board
Overview	C-Grid III™
Product Name	C-Grid III™

**Physical**

Breakaway	No
Circuits (Loaded)	18
Circuits (maximum)	18
Color - Resin	Black
Durability (mating cycles max)	30
First Mate / Last Break	No
Glow-Wire Compliant	No
Guide to Mating Part	No
Keying to Mating Part	None
Lock to Mating Part	None
Material - Metal	Brass
Material - Plating Mating	Tin
Material - Plating Termination	Tin
Material - Resin	High Temperature Thermoplastic
Number of Rows	2
Orientation	Right Angle
PC Tail Length (in)	0.083 In
PC Tail Length (mm)	2.10 mm
PCB Locator	No
PCB Retention	None
PCB Thickness Recommended (in)	0.063 In
PCB Thickness Recommended (mm)	1.60 mm
Packaging Type	Tray
Pitch - Mating Interface (in)	0.100 In
Pitch - Mating Interface (mm)	2.54 mm
Pitch - Term. Interface (in)	0.100 In
Pitch - Term. Interface (mm)	2.54 mm
Plating min: Mating (µin)	120
Plating min: Mating (µm)	3
Plating min: Termination (µin)	120
Plating min: Termination (µm)	3
Polarized to Mating Part	Yes
Polarized to PCB	No
Shrouded	Closed Ends
Stackable	No
Surface Mount Compatible (SMC)	Yes
Temperature Range - Operating	-55°C to +125°C
Termination Interface: Style	Through Hole

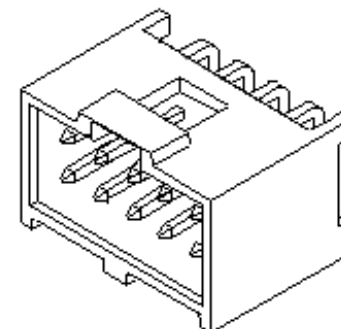

Series image - Reference only

**EU RoHS**

**ELV and RoHS Compliant**

**REACH SVHC**

**Contains SVHC: No**

**Halogen-Free**

**Status**

**Not Reviewed**

**China RoHS**



**Need more information on product environmental compliance?**

Email [productcompliance@molex.com](mailto:productcompliance@molex.com)  
Please visit the [Contact Us](#) section for any non-product compliance questions.

**Search Parts in this Series**

[91814 Series](#)

**Mates With**

[90142 C-Grid III™ Crimp Housing](#). [90119 C-Grid III™ Crimp Terminal](#)

**Electrical**

Current - Maximum	3A
Voltage - Maximum	350V AC/DC

**Solder Process Data**

Duration at Max. Process Temperature (seconds)	5
Lead-free Process Capability	Reflow Capable (SMT only)
Max. Cycles at Max. Process Temperature	1
Process Temperature max. C	260

**Material Info**

This document was generated on 11/16/2009

**PLEASE CHECK [WWW.MOLEX.COM](http://WWW.MOLEX.COM) FOR LATEST PART INFORMATION**