

FEATURES

- EIA SIZES A (1210), B (1812) AND C (1008)
- EXCELLENT HIGH Q AND HIGH SRF CHARACTERISTICS
- BOTH FLOW AND REFLOW SOLDERING APPLICABLE
- HIGH INDUCTANCE AVAILABLE IN SMALL SIZE
- EMBOSSED PLASTIC TAPE PACKAGE FOR AUTOMATIC PICK-PLACE

**RoHS
Compliant**

*See Part Number System for Details



AVAILABLE TYPE AND RANGE

EIA Size	Size Code	Size (L x W x H mm)	NIC Type	Inductance Range	Style	Page
1008	C	2.5 x 2.0 x 1.6	NIN-FC	0.22 ~ 100 μ H	Standard	224
			NIN-NC	10nH ~ 0.82 μ H	High Frequency	225
			NIN-PC	1.0 ~ 33 μ H	High Current	226
1210	A	3.2 x 2.5 x 2.2	NIN-FA	0.22 ~ 220 μ H	Standard	227
			NIN-NA	47nH ~ 8.2 μ H	High Frequency	228
			NIN-PA	1.0 ~ 330 μ H	High Current	229
1812	B	4.5 x 3.2 x 3.2	NIN-FB	0.10 ~ 1000 μ H	Standard	222-223

SPECIFICATIONS

Specifications	Case Size		
	1008	1210	1812
Inductance Range	10nH ~ 100 μ H	47nH ~ 330 μ H	0.10 μ H ~ 1000 μ H
Inductance Tolerance	\pm 20% (M), \pm 10% (K), \pm 5% (J)		\pm 10% (K), \pm 5% (J)
Operating Temperature Range	-25°C ~ +85°C (at 100% of rated voltage)		
Insulation Resistance	1,000 MegOhm Min. (@ 100Vdc, Termination to Case)		
Withstanding Voltage	250 Vdc for 1 minute (Termination to Case)		
Q-Factor, Self Resonant Frequency DC Resistance, Rated DC Current and Inductance Tolerance	See Individual Product Listings		

ENVIRONMENTAL CHARACTERISTICS

Test	Specification	Test Method & Condition
Solderability	90% Min. Coverage	After 3 Sec. Dip in +230°C Solder Pot (Post Flux)
Humidity	(1) No Evidence of Damage	After 500 Hrs at 60°C and 90 ~ 95% RH
Soldering Effect	(2) Inductance Shall Be Within \pm 5% of initial Value	After 5 Seconds at -260°C (5 Min. 120°C Pre-Heat)
Low Frequency Vibration	(3) Q Factor Shall Be Within \pm 10 of initial Value	After 2 Hrs per Axis, 10 ~ 55Hz, 1.5 mm Ampl
Thermal Shock		After 100 cycles (-40° to +85°C) 30 Min. Each
Low Temperature Storage		After 500 Hrs at -40°C
High Temperature Load Life	(1) No Evidence of Damage (2) Inductance Shall Be Within \pm 10% of Initial Value	After 500 Hrs at +85°C with rated DC Current
Humidity Load Life	(3) Q Factor Shall Be Within \pm 10% of Initial Value	After 500 Hrs at 60°C with 90 ~ 95% RH with Rated DC Current

For Quality Factor (**Q**) and Inductance (**L**) over Frequency curves see www.RFpassives.com

NIN-FB B-SIZE (1812) STANDARD VALUES

NIC P/N	'L' Inductance (uH)	Tolerance		'Q' Factor (min.)	L & Q Test Freq.	SRF Mhz (min.)	DC Resistance (ohms) Max.	Rated DC Current (mA) Max.
		(std)	(opt)					
NIN-FBR10xTR	0.10	±20% (M)	±10% (K)	28	25.2 Mhz	700	0.44	450
NIN-FBR12xTR	0.12	±20% (M)	±10% (K)	30	25.2 Mhz	500	0.22	450
NIN-FBR15xTR	0.15	±20% (M)	±10% (K)	30	25.2 Mhz	450	0.25	450
NIN-FBR18xTR	0.18	±20% (M)	±10% (K)	30	25.2 Mhz	400	0.28	450
NIN-FBR22xTR	0.22	±20% (M)	±10% (K)	30	25.2 Mhz	350	0.32	450
NIN-FBR27xTR	0.27	±20% (M)	±10% (K)	30	25.2 Mhz	320	0.36	450
NIN-FBR33xTR	0.33	±20% (M)	±10% (K)	30	25.2 Mhz	300	0.40	450
NIN-FBR39xTR	0.39	±20% (M)	±10% (K)	30	25.2 Mhz	250	0.45	450
NIN-FBR47xTR	0.47	±20% (M)	±10% (K)	30	25.2 Mhz	220	0.50	450
NIN-FBR56xTR	0.56	±20% (M)	±10% (K)	30	25.2 Mhz	180	0.55	450
NIN-FBR68xTR	0.68	±20% (M)	±10% (K)	30	25.2 Mhz	160	0.60	450
NIN-FBR82xTR	0.82	±20% (M)	±10% (K)	30	25.2 Mhz	140	0.67	450
NIN-FB1R0xTR	1.0	±20% (M)	±10% (K)	50	7.96 Mhz	100	0.50	450
NIN-FB1R2xTR	1.2	±20% (M)	±10% (K)	50	7.96 Mhz	80	0.55	430
NIN-FB1R5xTR	1.5	±20% (M)	±10% (K)	50	7.96 Mhz	70	0.60	410
NIN-FB1R8xTR	1.8	±20% (M)	±10% (K)	50	7.96 Mhz	60	0.65	390
NIN-FB2R2xTR	2.2	±20% (M)	±10% (K)	50	7.96 Mhz	55	0.70	380
NIN-FB2R7xTR	2.7	±20% (M)	±10% (K)	50	7.96 Mhz	50	0.75	370
NIN-FB3R3xTR	3.3	±20% (M)	±10% (K)	50	7.96 Mhz	45	0.80	355
NIN-FB3R9xTR	3.9	±20% (M)	±10% (K)	50	7.96 Mhz	40	0.90	330
NIN-FB4R7xTR	4.7	±20% (M)	±10% (K)	50	7.96 Mhz	35	1.0	315
NIN-FB5R6xTR	5.6	±20% (M)	±10% (K)	50	7.96 Mhz	33	1.1	300
NIN-FB6R8xTR	6.8	±10% (K)	±5% (J)	50	7.96 Mhz	27	1.2	285
NIN-FB8R2xTR	8.2	±10% (K)	±5% (J)	50	7.96 Mhz	25	1.4	270

For Quality Factor (**Q**) and Inductance (**L**)
over Frequency curves
see www.RFpassives.com

NIN-FB B-SIZE (1812) STANDARD VALUES

NIC P/N	'L' Inductance (μH)	Tolerance		'Q' Factor (min.)	L & Q Test Freq.	SRF Mhz (min.)	DC Resistance (ohms) Max.	Rated DC Current (mA) Max.
		(std)	(opt)					
NIN-FB100xTR	10	±10% (K)	±5% (J)	50	2.52 Mhz	20	1.6	250
NIN-FB120xTR	12	±10% (K)	±5% (J)	50	2.52 Mhz	18	2.0	225
NIN-FB150xTR	15	±10% (K)	±5% (J)	50	2.52 Mhz	17	2.5	200
NIN-FB180xTR	18	±10% (K)	±5% (J)	50	2.52 Mhz	15	2.8	190
NIN-FB220xTR	22	±10% (K)	±5% (J)	50	2.52 Mhz	13	3.2	180
NIN-FB270xTR	27	±10% (K)	±5% (J)	50	2.52 Mhz	12	3.6	170
NIN-FB330xTR	33	±10% (K)	±5% (J)	50	2.52 Mhz	11	4.0	160
NIN-FB390xTR	39	±10% (K)	±5% (J)	50	2.52 Mhz	10	4.5	150
NIN-FB470xTR	47	±10% (K)	±5% (J)	50	2.52 Mhz	10	5.0	140
NIN-FB560xTR	56	±10% (K)	±5% (J)	50	2.52 Mhz	9.3	5.5	135
NIN-FB680xTR	68	±10% (K)	±5% (J)	50	2.52 Mhz	9.0	6.0	130
NIN-FB820xTR	82	±10% (K)	±5% (J)	50	2.52 Mhz	8.2	7.0	120
NIN-FB101xTR	100	±10% (K)	±5% (J)	40	2.52 Mhz	6.7	8.8	105
NIN-FB121xTR	120	±10% (K)	±5% (J)	40	1.5 Mhz	6.1	10	100
NIN-FB151xTR	150	±10% (K)	±5% (J)	40	1.5 Mhz	5.5	11	95
NIN-FB181xTR	180	±10% (K)	±5% (J)	40	1.5 Mhz	5.1	13	85
NIN-FB221xTR	220	±10% (K)	±5% (J)	40	0.796 Mhz	4.5	13	85
NIN-FB271xTR	270	±10% (K)	±5% (J)	40	0.796 Mhz	4.1	14	80
NIN-FB331xTR	330	±10% (K)	±5% (J)	40	0.796 Mhz	3.7	16	75
NIN-FB391xTR	390	±10% (K)	±5% (J)	40	0.796 Mhz	3.3	19	70
NIN-FB471xTR	470	±10% (K)	±5% (J)	30	0.796 Mhz	3.3	31	55
NIN-FB561xTR	560	±10% (K)	±5% (J)	30	0.796 Mhz	2.7	35	50
NIN-FB681xTR	680	±10% (K)	±5% (J)	30	0.796 Mhz	2.5	39	50
NIN-FB821xTR	820	±10% (K)	±5% (J)	30	0.796 Mhz	2.4	45	45
NIN-FB102xTR	1000	±10% (K)	±5% (J)	30	0.796 Mhz	2.1	53	40

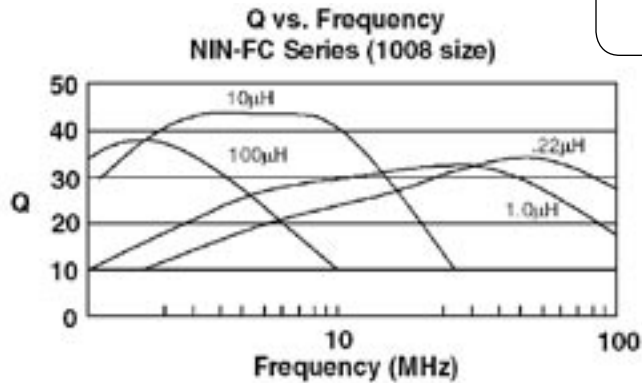

For Quality Factor (Q) and Inductance (L) over Frequency curves see www.RFpassives.com

NIN-FC SERIES C SIZE (1008) STANDARD TYPE

NIC P/N	'L' Inductance (µH)	Tolerance		'Q' Factor (min.)	L & Q Test Freq.	SRF Mhz (min.)	DC Resistance (ohms) Max.	Rated DC Current (mA) Max.
		(std)	(opt)					
NIN-FCR22xTR	0.22	±20% (M)	±10% (K)	25	25.2 Mhz	230	0.70	190
NIN-FCR27xTR	0.27	±20% (M)	±10% (K)	25	25.2 Mhz	210	0.75	180
NIN-FCR33xTR	0.33	±20% (M)	±10% (K)	25	25.2 Mhz	190	0.85	170
NIN-FCR39xTR	0.39	±20% (M)	±10% (K)	25	25.2 Mhz	175	0.95	160
NIN-FCR47xTR	0.47	±20% (M)	±10% (K)	25	25.2 Mhz	160	1.00	155
NIN-FCR56xTR	0.56	±20% (M)	±10% (K)	25	25.2 Mhz	150	1.10	150
NIN-FCR68xTR	0.68	±20% (M)	±10% (K)	25	25.2 Mhz	135	1.25	140
NIN-FCR82xTR	0.82	±20% (M)	±10% (K)	25	25.2 Mhz	125	1.4	130
NIN-FC1R0 xTR	1.0	±10% (K)	±5% (J)	25	7.96 Mhz	115	0.65	195
NIN-FC1R2 xTR	1.2	±10% (K)	±5% (J)	25	7.96 Mhz	100	0.75	180
NIN-FC1R5 xTR	1.5	±10% (K)	±5% (J)	25	7.96 Mhz	90	0.85	170
NIN-FC1R8 xTR	1.8	±10% (K)	±5% (J)	25	7.96 Mhz	85	0.95	160
NIN-FC2R2xTR	2.2	±10% (K)	±5% (J)	25	7.96 Mhz	80	1.05	155
NIN-FC2R7 xTR	2.7	±10% (K)	±5% (J)	25	7.96 Mhz	75	1.20	145
NIN-FC3R3 xTR	3.3	±10% (K)	±5% (J)	25	7.96 Mhz	65	1.30	135
NIN-FC3R9 xTR	3.9	±10% (K)	±5% (J)	25	7.96 Mhz	60	1.40	130
NIN-FC4R7 xTR	4.7	±10% (K)	±5% (J)	25	7.96 Mhz	55	1.55	125
NIN-FC5R6 xTR	5.6	±10% (K)	±5% (J)	25	7.96 Mhz	50	1.75	120
NIN-FC6R8 xTR	6.8	±10% (K)	±5% (J)	25	7.96 Mhz	45	1.95	115
NIN-FC8R2 xTR	8.2	±10% (K)	±5% (J)	25	7.96 Mhz	40	2.20	105
NIN-FC100 xTR	10	±10% (K)	±5% (J)	25	2.52 Mhz	32	3.50	80
NIN-FC120 xTR	12	±10% (K)	±5% (J)	25	2.52 Mhz	30	3.80	75
NIN-FC150 xTR	15	±10% (K)	±5% (J)	25	2.52 Mhz	28	4.40	70
NIN-FC180 xTR	18	±10% (K)	±5% (J)	25	2.52 Mhz	25	5.00	65
NIN-FC220 xTR	22	±10% (K)	±5% (J)	25	2.52 Mhz	22	5.80	60
NIN-FC270 xTR	27	±10% (K)	±5% (J)	20	2.52 Mhz	21	6.30	115
NIN-FC330 xTR	33	±10% (K)	±5% (J)	20	2.52 Mhz	20	7.10	110
NIN-FC390 xTR	39	±10% (K)	±5% (J)	20	2.52 Mhz	18	9.50	90
NIN-FC470 xTR	47	±10% (K)	±5% (J)	20	2.52 Mhz	17	11.0	80
NIN-FC560 xTR	56	±10% (K)	±5% (J)	20	2.52 Mhz	16	12.1	75
NIN-FC680 xTR	68	±10% (K)	±5% (J)	20	2.52 Mhz	15	16.6	70
NIN-FC820 xTR	82	±10% (K)	±5% (J)	20	2.52 Mhz	13	19.0	65
NIN-FC101 xTR	100	±10% (K)	±5% (J)	15	0.796 Mhz	12	21.0	60

Q vs Frequency
NIN-NC Series (1008 size)
High Frequency Type

For Quality Factor (Q) and Inductance (L) over Frequency curves see www.RFpassives.com

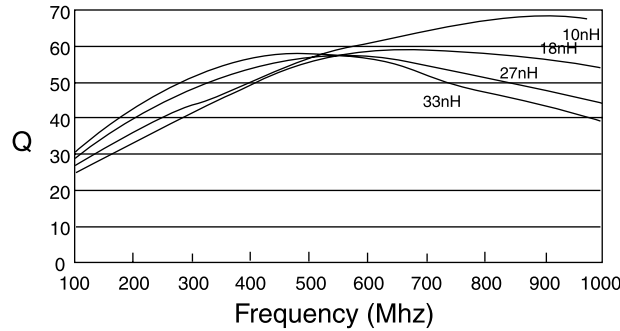

NIN-NC SERIES C SIZE (1008) HIGH FREQUENCY TYPE

NIC P/N	'L' Inductance (nH)	Tolerance		'Q' Factor (min.)	L & Q Test Freq.	SRF Mhz (min.)	DC Resistance (ohms) Max.	Rated DC Current (mA) Max.
		(std)	(opt)					
NIN-NC10NKTR	10	±10% (K)	---	10	100 Mhz	2500	0.32	280
NIN-NC12NKTR	12	±10% (K)	---	10	100 Mhz	2200	0.34	270
NIN-NC15NKTR	15	±10% (K)	---	10	100 Mhz	1800	0.38	255
NIN-NC18NKTR	18	±10% (K)	---	10	100 Mhz	1550	0.40	250
NIN-NC22NKTR	22	±10% (K)	---	15	100 Mhz	1350	0.43	240
NIN-NC27NKTR	27	±10% (K)	---	15	100 Mhz	1150	0.47	230
NIN-NC33NxTR	33	±10% (K)	±5% (J)	15	100 Mhz	1000	0.51	220
NIN-NC39NxTR	39	±10% (K)	±5% (J)	15	100 Mhz	890	0.55	215
NIN-NC47NxTR	47	±10% (K)	±5% (J)	15	100 Mhz	770	0.59	205
NIN-NC56NxTR	56	±10% (K)	±5% (J)	15	100 Mhz	670	0.63	200
NIN-NC68NxTR	68	±10% (K)	±5% (J)	15	100 Mhz	590	0.68	190
NIN-NC82NxTR	82	±10% (K)	±5% (J)	15	100 Mhz	520	0.73	185
NIN-NCR10xTR	100	±10% (K)	±5% (J)	10	25.2 Mhz	460	0.80	175
NIN-NCR12xTR	120	±10% (K)	±5% (J)	10	25.2 Mhz	400	0.87	170
NIN-NCR15xTR	150	±10% (K)	±5% (J)	10	25.2 Mhz	340	0.98	160
NIN-NCR18xTR	180	±10% (K)	±5% (J)	10	25.2 Mhz	300	1.05	155
NIN-NCR22xTR	220	±10% (K)	±5% (J)	10	25.2 Mhz	260	1.15	145
NIN-NCR27xTR	270	±10% (K)	±5% (J)	10	25.2 Mhz	230	1.25	140
NIN-NCR33xTR	330	±10% (K)	±5% (J)	10	25.2 Mhz	200	1.37	135
NIN-NCR39xTR	390	±10% (K)	±5% (J)	10	25.2 Mhz	180	1.47	130
NIN-NCR47xTR	470	±10% (K)	±5% (J)	10	25.2 Mhz	160	1.58	125
NIN-NCR56xTR	560	±10% (K)	±5% (J)	10	25.2 Mhz	145	1.70	120
NIN-NCR68xTR	680	±10% (K)	±5% (J)	10	25.2 Mhz	130	1.85	110
NIN-NCR82xTR	820	±10% (K)	±5% (J)	10	25.2 Mhz	100	2.10	100

For Quality Factor (**Q**) and Inductance (**L**)
over Frequency curves
see www.RFpassives.com

NIN-PC SERIES C SIZE (1008) HIGH CURRENT TYPE

NIC P/N	'L' Inductance (μ H)	Tolerance		'Q' Factor (min.)	L & Q Test Freq.	SRF Mhz (min.)	DC Resistance (ohms) Max.	Rated DC Current (mA) Max.
		(std)	(opt)					
NIN-PC1R0MTR	1.0	$\pm 20\%$	---	10	7.96 Mhz	95	0.45	475
NIN-PC1R5MTR	1.5	$\pm 20\%$	---	10	7.96 Mhz	85	0.55	435
NIN-PC2R2MTR	2.2	$\pm 20\%$	---	10	7.96 Mhz	65	0.65	390
NIN-PC3R3MTR	3.3	$\pm 20\%$	---	8	7.96 Mhz	55	0.85	340
NIN-PC4R7MTR	4.7	$\pm 20\%$	---	8	7.96 Mhz	43	1.2	285
NIN-PC6R8KTR	6.8	$\pm 10\%$	---	8	7.96 Mhz	39	1.3	275
NIN-PC100KTR	10	$\pm 10\%$	---	20	2.52 Mhz	32	2.2	210
NIN-PC120KTR	12	$\pm 10\%$	---	20	2.52 Mhz	25	2.7	195
NIN-PC150KTR	15	$\pm 10\%$	---	20	2.52 Mhz	21	3.2	175
NIN-PC220KTR	22	$\pm 10\%$	---	20	2.52 Mhz	18	4.0	160
NIN-PC330KTR	33	$\pm 10\%$	---	20	2.52 Mhz	16	6.5	120

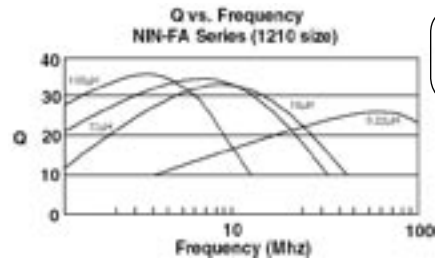

For Quality Factor (Q) and Inductance (L) over Frequency curves see www.RFpassives.com

NIN-FA SERIES A SIZE (1210) STANDARD TYPE

NIC P/N	'L' Inductance (μH)	Tolerance		'Q' Factor (min.)	L & Q Test Freq.	SRF Mhz (min.)	DC Resistance (ohms) Max.	Rated DC Current (mA) Max.
		(std)	(opt)					
NIN-FAR22xTR	0.22	±20% (M)	±10% (K)	25	25.2 Mhz	230	0.29	360
NIN-FAR27xTR	0.27	±20% (M)	±10% (K)	25	25.2 Mhz	210	0.32	345
NIN-FAR33xTR	0.33	±20% (M)	±10% (K)	25	25.2 Mhz	190	0.35	330
NIN-FAR39xTR	0.39	±20% (M)	±10% (K)	25	25.2 Mhz	175	0.39	305
NIN-FAR47xTR	0.47	±20% (M)	±10% (K)	25	25.2 Mhz	160	0.44	290
NIN-FAR56xTR	0.56	±20% (M)	±10% (K)	25	25.2 Mhz	150	0.49	275
NIN-FAR68xTR	0.68	±20% (M)	±10% (K)	25	25.2 Mhz	135	0.55	260
NIN-FAR82xTR	0.82	±20% (M)	±10% (K)	25	25.2 Mhz	125	0.61	245
NIN-FA1R0xTR	1.0	±10% (K)	±5% (J)	30	7.96 Mhz	115	0.69	230
NIN-FA1R2xTR	1.2	±10% (K)	±5% (J)	30	7.96 Mhz	100	0.75	215
NIN-FA1R5xTR	1.5	±10% (K)	±5% (J)	30	7.96 Mhz	90	0.75	210
NIN-FA1R8xTR	1.8	±10% (K)	±5% (J)	30	7.96 Mhz	85	0.82	200
NIN-FA2R2xTR	2.2	±10% (K)	±5% (J)	30	7.96 Mhz	80	0.95	190
NIN-FA2R7xTR	2.7	±10% (K)	±5% (J)	30	7.96 Mhz	75	1.1	180
NIN-FA3R3xTR	3.3	±10% (K)	±5% (J)	30	7.96 Mhz	65	1.2	180
NIN-FA3R9xTR	3.9	±10% (K)	±5% (J)	30	7.96 Mhz	60	1.3	175
NIN-FA4R7xTR	4.7	±10% (K)	±5% (J)	30	7.96 Mhz	55	1.5	165
NIN-FA5R6xTR	5.6	±10% (K)	±5% (J)	30	7.96 Mhz	50	1.6	160
NIN-FA6R8xTR	6.8	±10% (K)	±5% (J)	30	7.96 Mhz	45	1.8	150
NIN-FA8R2xTR	8.2	±10% (K)	±5% (J)	30	7.96 Mhz	40	2.0	140
NIN-FA100xTR	10	±10% (K)	±5% (J)	30	2.52 Mhz	36	2.1	140
NIN-FA120xTR	12	±10% (K)	±5% (J)	30	2.52 Mhz	33	2.5	125
NIN-FA150xTR	15	±10% (K)	±5% (J)	30	2.52 Mhz	30	2.8	120
NIN-FA180xTR	18	±10% (K)	±5% (J)	30	2.52 Mhz	27	3.3	110
NIN-FA220xTR	22	±10% (K)	±5% (J)	30	2.52 Mhz	25	3.7	105
NIN-FA270xTR	27	±10% (K)	±5% (J)	30	2.52 Mhz	22	5.0	90
NIN-FA330xTR	33	±10% (K)	±5% (J)	30	2.52 Mhz	20	5.6	85
NIN-FA390xTR	39	±10% (K)	±5% (J)	30	2.52 Mhz	20	6.4	80
NIN-FA470xTR	47	±10% (K)	±5% (J)	30	2.52 Mhz	15	7.0	75
NIN-FA560xTR	56	±10% (K)	±5% (J)	30	2.52 Mhz	15	8.0	70
NIN-FA680xTR	68	±10% (K)	±5% (J)	30	2.52 Mhz	15	9.0	65
NIN-FA820xTR	82	±10% (K)	±5% (J)	30	2.52 Mhz	11	10	60
NIN-FA101xTR	100	±10% (K)	±5% (J)	20	0.796 Mhz	10	10	60
NIN-FA121xTR	120	±10% (K)	±5% (J)	20	0.796 Mhz	10	11	55
NIN-FA151xTR	150	±10% (K)	±5% (J)	20	0.796 Mhz	8	15	50
NIN-FA181xTR	180	±10% (K)	±5% (J)	20	0.796 Mhz	7	17	50
NIN-FA221xTR	220	±10% (K)	±5% (J)	20	0.796 Mhz	7	21	45

Q vs Frequency NIN-NA Series (1210 Size)

For Quality Factor (Q) and Inductance (L) over Frequency curves see www.RFpassives.com

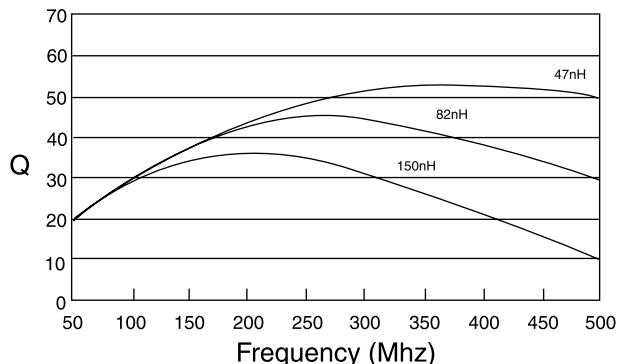

NIN-NA SERIES A SIZE (1210) HIGH FREQUENCY

NIC P/N	'L' Inductance (μH)	Tolerance	'Q' Factor (min.)	L & Q Test Freq.	SRF Mhz (min.)	DC Resistance (ohms) Max.	Rated DC Current (mA) Max.
NIN-NA47NMTR	0.047	±20% (M)	10	100 Mhz	680	0.20	450
NIN-NA56NMTR	0.056	±20% (M)	10	100 Mhz	600	0.22	420
NIN-NA68NMTR	0.068	±20% (M)	10	100 Mhz	540	0.25	400
NIN-NA82NMTR	0.082	±20% (M)	10	100 Mhz	500	0.27	380
NIN-NAR10MTR	0.10	±20% (M)	10	100 Mhz	450	0.30	360
NIN-NAR12MTR	0.12	±20% (M)	10	25.2 Mhz	400	0.67	240
NIN-NAR15MTR	0.15	±20% (M)	10	25.2 Mhz	350	0.72	230
NIN-NAR18MTR	0.18	±20% (M)	10	25.2 Mhz	320	0.81	220
NIN-NAR22KTR	0.22	±10% (K)	10	25.2 Mhz	280	0.90	210
NIN-NAR27KxTR	0.27	±10% (K)	10	25.2 Mhz	250	1.0	200
NIN-NAR33KTR	0.33	±10% (K)	10	25.2 Mhz	220	1.1	190
NIN-NAR39KTR	0.39	±10% (K)	10	25.2 Mhz	200	1.2	180
NIN-NAR47KTR	0.47	±10% (K)	10	25.2 Mhz	180	1.4	175
NIN-NAR56KTR	0.56	±10% (K)	10	25.2 Mhz	160	1.5	170
NIN-NAR68KTR	0.68	±10% (K)	10	25.2 Mhz	150	1.7	155
NIN-NAR82KTR	0.82	±10% (K)	10	25.2 Mhz	135	1.9	145
NIN-NA1R0JTR	1.0	±5% (J)	13	7.96 Mhz	120	2.1	125
NIN-NA1R2JTR	1.2	±5% (J)	13	7.96 Mhz	110	2.3	120
NIN-NA1R5JTR	1.5	±5% (J)	13	7.96 Mhz	95	2.7	115
NIN-NA1R8JTR	1.8	±5% (J)	13	7.96 Mhz	85	3.0	110
NIN-NA2R2JTR	2.2	±5% (J)	13	7.96 Mhz	80	3.2	110
NIN-NA2R7JTR	2.7	±5% (J)	13	7.96 Mhz	70	3.6	105
NIN-NA3R3JTR	3.3	±5% (J)	13	7.96 Mhz	62	4.2	100
NIN-NA3R9JTR	3.9	±5% (J)	13	7.96 Mhz	57	4.4	95
NIN-NA4R7JTR	4.7	±5% (J)	13	7.96 Mhz	52	7.7	70
NIN-NA5R6JTR	5.6	±5% (J)	13	7.96 Mhz	46	8.7	65
NIN-NA6R8JTR	6.8	±5% (J)	13	7.96 Mhz	42	10	60
NIN-NA8R2JTR	8.2	±5% (J)	13	7.96 Mhz	38	11	60

For Quality Factor (**Q**) and Inductance (**L**)
over Frequency curves
see www.RFpassives.com

NIN-PA SERIES A SIZE (1210) HIGH CURRENT TYPE

NIC P/N	'L' Inductance (μ H)	Tolerance		'Q' Factor (min.)	L & Q Test Freq.	SRF Mhz (min.)	DC Resistance (ohms) Max.	Rated DC Current (mA) Max.
		(std)	(opt)					
NIN-PA1R0MTR	1.0	$\pm 20\%$ (M)	----	7	7.96 Mhz	150	0.15	600
NIN-PA1R5MTR	1.5	$\pm 20\%$ (M)	----	7	7.96 Mhz	110	0.18	550
NIN-PA2R2MTR	2.2	$\pm 20\%$ (M)	----	7	7.96 Mhz	80	0.23	500
NIN-PA3R3MTR	3.3	$\pm 20\%$ (M)	----	7	7.96 Mhz	58	0.28	400
NIN-PA4R7MTR	4.7	$\pm 20\%$ (M)	----	7	7.96 Mhz	46	0.34	350
NIN-PA6R8MTR	6.8	$\pm 20\%$ (M)	----	7	7.96 Mhz	38	0.42	300
NIN-PA100KTR	10	$\pm 10\%$ (K)	----	15	2.52 Mhz	23	0.50	240
NIN-PA120KTR	12	$\pm 10\%$ (K)	----	15	2.52 Mhz	21	0.60	230
NIN-PA150KTR	15	$\pm 10\%$ (K)	----	15	2.52 Mhz	18	0.74	220
NIN-PA180KTR	18	$\pm 10\%$ (K)	----	15	2.52 Mhz	17	0.90	205
NIN-PA220KTR	22	$\pm 10\%$ (K)	----	15	2.52 Mhz	15	1.15	185
NIN-PA270KTR	27	$\pm 10\%$ (K)	----	15	2.52 Mhz	13	1.45	165
NIN-PA330KTR	33	$\pm 10\%$ (K)	----	15	2.52 Mhz	12	1.65	155
NIN-PA390KTR	39	$\pm 10\%$ (K)	----	15	2.52 Mhz	11	1.90	145
NIN-PA470KTR	47	$\pm 10\%$ (K)	----	15	2.52 Mhz	9.5	2.25	135
NIN-PA560KTR	56	$\pm 10\%$ (K)	----	15	2.52 Mhz	8.5	3.30	110
NIN-PA680KTR	68	$\pm 10\%$ (K)	----	15	2.52 Mhz	7.5	3.70	105
NIN-PA820KTR	82	$\pm 10\%$ (K)	----	15	2.52 Mhz	7.0	4.20	100
NIN-PA101KTR	100	$\pm 10\%$ (K)	----	20	0.796 Mhz	6.5	5.0	90
NIN-PA121KTR	120	$\pm 10\%$ (K)	----	20	0.796 Mhz	6.0	7.0	75
NIN-PA151KTR	150	$\pm 10\%$ (K)	----	20	0.796 Mhz	5.5	8.0	70
NIN-PA181KTR	180	$\pm 10\%$ (K)	----	20	0.796 Mhz	5.0	9.5	65
NIN-PA221KTR	220	$\pm 10\%$ (K)	----	20	0.796 Mhz	4.0	11.0	60
NIN-PA271KTR	270	$\pm 10\%$ (K)	----	20	0.796 Mhz	3.5	14.5	55
NIN-PA331KTR	330	$\pm 10\%$ (K)	----	20	0.796 Mhz	3.0	16.0	50

PACKAGING SPECIFICATIONS

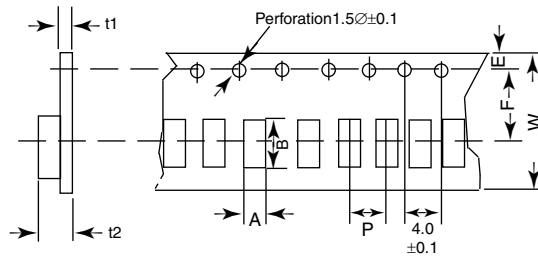

CARRIER TAPE DIMENSIONS (mm)

Case Code	Type	Size	W ± 0.3	A ± 0.2	B ± 0.2	P ± 0.1	E ± 0.1	F ± 0.1	t1	t2
B	FC/NC/PC	C	8.0	2.4	2.9	4.0	1.75	3.5	0.25	1.85
C	FA/NA/PA	A	8.0	2.8	3.6	4.0	1.75	3.5	0.25	2.4
D	FB	B	12.0	3.6	4.9	8.0	1.75	5.5	0.3	3.5

DIMENSIONS (mm)

Case Code	Type	Size	D $\varnothing \pm 2$	W ± 1.5	Qty/Reel
B	FC/NC/PC	C	180	9.0	2000 pcs
C	FA/NA/PA	A	180	9.0	2000 pcs
D	FB	B	180	13.0	500 pcs

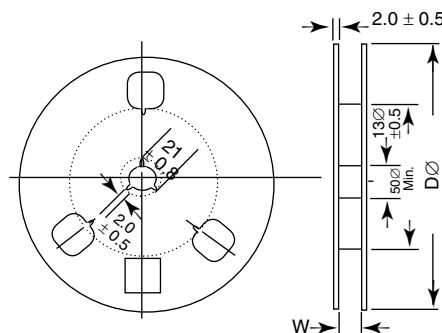

RECOMMENDED LAND PATTERNS FOR FLOW AND REFLOW SOLDERING

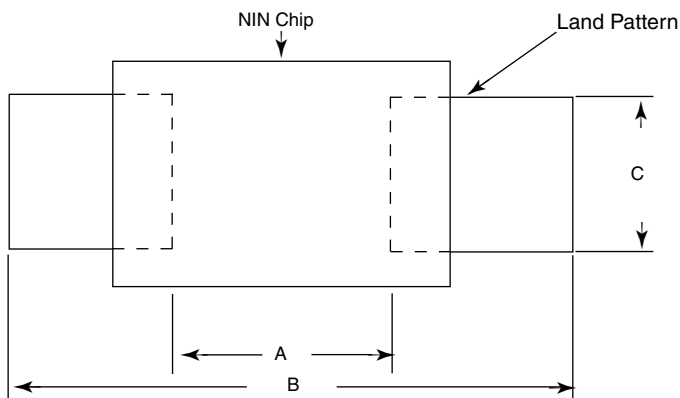

DIMENSIONS (mm)

	Type	Size	A	B	C
B	FC/NC/PC	C	1.4~1.5	3.5~4.0	1.2~1.6
C	FA/NA/PA	A	1.6~2.0	4.0~4.6	1.9~2.4
D	FB	B	2.4~2.6	5.5~6.0	2.0~3.0