

AEH Half-brick Series

Technical Reference Notes

24V Input, 2.5V, 3.3V, 5V Single Output

50-150W DC-DC Converter

(Rev01)



Introduction

The AEH 24Vin series comes in a industry standard half-brick package of **2.4" x 2.28" x 0.5"** and footprint. The AEH 24Vin series is available with 2:1 input range of 18-36V. Outputs of 2.5V, 3.3V, and 5V are fully isolated from input and the isolation voltage is 1500Vdc. **The typical efficiencies are 88% for the 5V output, 87% for the 3.3V output, and 86% for the 2.5V output.**

Designed using a synchronous rectification topology, AEH 24Vin series incorporates simple structure, good electrical performance and high reliability. Standard features include input LVP, OCP, output OVP, short circuit protection, and over-temperature protection. Using aluminum based plate, the maximum case temperature can reach 100 °C.

The AEH 24Vin series is designed to meet CISPR22, FCC Class A, UL, TUV, and CSA certifications.

Design Features

- ☞ High Efficiency
- ☞ High power density
- ☞ Low output noise
- ☞ Metal baseplate
- ☞ CNT function
- ☞ Remote sense
- ☞ Trim function
- ☞ Input under-voltage lockout
- ☞ Output short circuit protection
- ☞ Output current limiting
- ☞ Output over-voltage protection
- ☞ Overtemperature protection
- ☞ High input-output isolation voltage

Options

- ☞ Heat sink available for extended operation
- ☞ Choice of CNT logic configuration

Typical Application

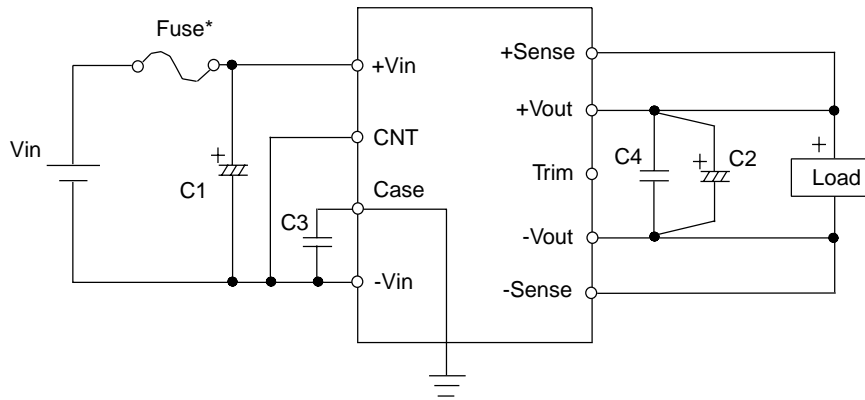

Fuse*: Use external fuse (fast blow type) for each unit.

50W output : 10A fuse

75W output : 15A fuse

100W output : 20A fuse

150W output : 30A fuse

C1: Recommended input capacitor C1

-40 °C~ +100 °C: $\geq 47\mu\text{F}/100\text{V}$ electrolytic capacitor.

C2: Recommended output capacitor C2

0°C~ +100°C: one 2200 $\mu\text{F}/6.3\text{V}$ electrolytic capacitor

Below 0°C: use 1 X 220 μF tantalum capacitor parallel with a 2200 $\mu\text{F}/6.3\text{V}$ electrolytic capacitor

C3: Recommended 4700pF/2000V

C4: Recommended 1 $\mu\text{F}/10\text{V}$

AEH 24V Input Half-Brick Series Power Converters
2.5V, 3.3V, 5V Single Output, 50-150W

Block Diagram

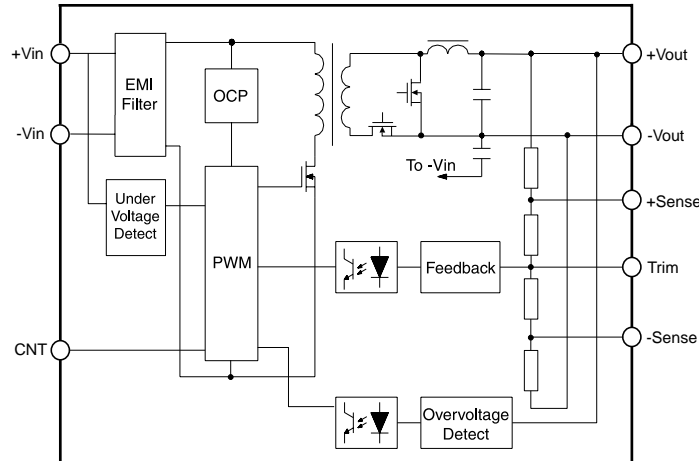

Ordering Information

Model Number	Input Voltage	Output Voltage	Output Current	Ripple (mV rms)	Noise (mV pp)	Efficiency	
						min	typ
AEH10G24(N)	18-36V	2.5V	10A	40	150	84%	86%
AEH10F24(N)	18-36V	3.3V	10A	40	150	85%	87%
AEH10A24(N)	18-36V	5V	10A	40	150	86%	88%
*AEH15G24(N)	18-36V	2.5V	15A	40	150	84%	86%
*AEH15F24(N)	18-36V	3.3V	15A	40	150	85%	87%
*AEH15A24(N)	18-36V	5V	15A	40	150	86%	88%
AEH20G24(N)	18-36V	2.5V	20A	40	150	84%	86%
AEH20F24(N)	18-36V	3.3V	20A	40	150	85%	87%
AEH20A24(N)	18-36V	5V	20A	40	150	86%	88%
*AEH30G24(N)	18-36V	2.5V	30A	40	150	84%	86%
*AEH30F24(N)	18-36V	3.3V	30A	40	150	84%	86%
*AEH30A24(N)	18-36V	5V	30A	40	150	86%	88%

*: detailed information referring to the factory

AEH 24V Input Half-Brick Series Power Converters
2.5V, 3.3V, 5V Single Output, 50-150W

Absolute Maximum Rating

Characteristic	Min	Typ	Max	Units	Notes
Input Voltage(continuous)	-0.3		40	Vdc	
Input Voltage(peak/surge)	-0.3		50	Vdc	100ms non-repetitive
Operating temperature	-40		100*	°C	*:case temperature
storage temperature	-55		125	°C	

Input Characteristics

Characteristic	Min	Typ	Max	Units	Notes
Input Voltage Range	18	24	36	Vdc	
Input Reflected Current		25	80	mAp-p	
Turn-off Input Voltage	14	15.5	17	V	
Turn-on Input Voltage	15	16.5	18	V	
Turn On Time		15	25	ms	

Control Function

Characteristic	Min	Typ	Max	Units	Notes
Logic High	3		15	Vdc	
Logic Low	-0.7		1.2	Vdc	
Control Current			2	mA	

General Specifications

Characteristic	Min	Typ	Max	Units	Notes
MTBF		1880		k Hrs	Bellcore TR332, Tc=30°C
Isolation			1500	Vdc	
Pin solder temperature			260	°C	wave solder < 10 s
Hand Soldering Time			5	s	iron temperature 425°C
Weight		70		grams	

AEH 24V Input Half-Brick Series Power Converters
2.5V, 3.3V, 5V Single Output, 50-150W

AEH10G24(N) Output Characteristics

Characteristic	Min	Typ	Max	Units	Notes
Power		25		W	
Output Current		10		A	
Output Setpoint Voltage	2.45	2.5	2.55	Vdc	Vin=24V, Io=10A
Line Regulation		0.02	0.2	%Vo	Vin=18-36V, Io=10A
Load Regulation		0.1	0.5	%Vo	Io=0-10A, Vin=24V
Dynamic Response					
50-75% load		1.5		%Vo	Ta=25°C, di/dt =1A/10µs
		100		µs	Ta=25°C, di/dt =1A/10µs
50-25% load		1.5		%Vo	Ta=25°C, di/dt =1A/10µs
		100		µs	Ta=25°C, di/dt =1A/10µs
Current Limit Threshold	11	12.5	14	A	
Short Circuit Current		17		A	
Efficiency	84	86		%	Vin=24V, Io=10A
Trim Range	90		110	%Vo	
Over Voltage Protection Setpoint	3		3.9	V	
Sense Compensation			0.5	V	0.25V each leg
Temperature Regulation			0.02	%Vo/°C	
Ripple (rms)		20	40	mV	(0 to 20MHz Bandwidth)
Noise (p-p)		100	150	mV	(0 to 20MHz Bandwidth)
Over Temperature Protection		105		°C	
Switching Frequency		230		kHz	

AEH 24V Input Half-Brick Series Power Converters
2.5V, 3.3V, 5V Single Output, 50-150W

AEH10F24(N) Output Characteristics

Characteristic	Min	Typ	Max	Units	Notes
Power		33		W	
Output Current		10		A	
Output Setpoint Voltage	3.25	3.3	3.35	Vdc	Vin=24V, Io=10A
Line Regulation		0.02	0.2	%Vo	Vin=18~36V, Io=10A
Load Regulation		0.1	0.5	%Vo	Io=0~10A, Vin=24V
Dynamic Response					
50-75% load		1.5		%Vo	Ta=25°C, di/dt =1A/10µs
		100		µs	Ta=25°C, di/dt =1A/10µs
50-25% load		1.5		%Vo	Ta=25°C, di/dt =1A/10µs
		100		µs	Ta=25°C, di/dt =1A/10µs
Current Limit Threshold	11	12.5	14	A	
Short Circuit Current		17		A	
Efficiency	85	87		%	Vin=24V, Io=10A
Trim Range	90		110	%Vo	
Over Voltage Protection Setpoint	3.9		5.0	V	
Sense Compensation			0.5	V	0.25V each leg
Temperature Regulation			0.02	%Vo/°C	
Ripple (rms)		20	40	mV	(0 to 20MHz Bandwidth)
Noise (p-p)		100	150	mV	(0 to 20MHz Bandwidth)
Over Temperature Protection		105		°C	
Switching Frequency		270		kHz	

AEH 24V Input Half-Brick Series Power Converters
2.5V, 3.3V, 5V Single Output, 50-150W

AEH10A24(N) Output Characteristics

Characteristic	Min	Typ	Max	Units	Notes
Power		50		W	
Output Current		10		A	
Output Setpoint Voltage	4.92	5.0	5.08	Vdc	Vin=24V, Io=10A
Line Regulation		0.02	0.2	%Vo	Vin=18~36V, Io=10A
Load Regulation		0.1	0.5	%Vo	Io=0~10A, Vin=24V
Dynamic Response					
50-75% load		1.5		%Vo	Ta=25°C, di/dt =1A/10µs
		100		µs	Ta=25°C, di/dt =1A/10µs
50-25% load		1.5		%Vo	Ta=25°C, di/dt =1A/10µs
		100		µs	Ta=25°C, di/dt =1A/10µs
Current Limit Threshold	11	12	14	A	
Short Circuit Current		17		A	
Efficiency	86	87		%	Vin=24V, Io=10A
Trim Range	90		110	%Vo	
Over Voltage Protection Setpoint	5.75		7	V	
Sense Compensation			0.5	V	0.25V each leg
Temperature Regulation			0.02	%Vo/°C	
Ripple (rms)		20	40	mV	(0 to 20MHz Bandwidth)
Noise (pp)		100	150	mV	(0 to 20MHz Bandwidth)
Over Temperature Protection		105		°C	
Switching Frequency		280		kHz	

AEH 24V Input Half-Brick Series Power Converters
2.5V, 3.3V, 5V Single Output, 50-150W

AEH20G24(N) Output Characteristics

Characteristic	Min	Typ	Max	Units	Notes
Power		50		W	
Output Current		20		A	
Output Setpoint Voltage	2.45	2.5	2.55	Vdc	Vin=24V, Io=20A
Line Regulation		0.02	0.2	%Vo	Vin=18~36V, Io=20A
Load Regulation		0.1	0.5	%Vo	Io=0~20A, Vin=24V
Dynamic Response					
50-75% load		1.5		%Vo	Ta=25°C, di/dt =1A/10µs
		100		µs	Ta=25°C, di/dt =1A/10µs
50-25% load		1.5		%Vo	Ta=25°C, di/dt =1A/10µs
		100		µs	Ta=25°C, di/dt =1A/10µs
Current Limit Threshold	22	25	28	A	
Short Circuit Current		30		A	
Efficiency	84	86		%	Vin=24V, Io=20A
Trim Range	90		110	%Vo	
Over Voltage Protection Setpoint	3		3.9	V	
Sense Compensation			0.5	V	0.25V each leg
Temperature Regulation			0.02	%Vo/°C	
Ripple (rms)		20	40	mV	(0 to 20MHz Bandwidth)
Noise (pp)		100	150	mV	(0 to 20MHz Bandwidth)
Over Temperature Protection		105		°C	
Switching Frequency		230		kHz	

AEH 24V Input Half-Brick Series Power Converters
2.5V, 3.3V, 5V Single Output, 50-150W

AEH20F24(N) Output Characteristics

Characteristic	Min	Typ	Max	Units	Notes
Power		66		W	
Output Current		20		A	
Output Setpoint Voltage	3.25	3.3	3.35	Vdc	Vin=24V, Io=20A
Line Regulation		0.02	0.2	%Vo	Vin=18~36V, Io=20A
Load Regulation		0.1	0.5	%Vo	Io=0~20A, Vin=24V
Dynamic Response					
50-75% load		1.5		%Vo	Ta=25°C, di/dt =1A/10µs
		100		µs	Ta=25°C, di/dt =1A/10µs
50-25% load		1.5		%Vo	Ta=25°C, di/dt =1A/10µs
		100		µs	Ta=25°C, di/dt =1A/10µs
Current Limit Threshold	22	25	28	A	
Short Circuit Current		30		A	
Efficiency	86	87		%	Vin=24V, Io=20A
Trim Range	90		110	%Vo	
Over Voltage Protection Setpoint	3.9		5.0	V	
Sense Compensation			0.5	V	0.25V each leg
Temperature Regulation			0.02	%Vo/°C	
Ripple (rms)		20	40	mV	(0 to 20MHz Bandwidth)
Noise (pp)		100	150	mV	(0 to 20MHz Bandwidth)
Over Temperature Protection		105		°C	
Switching Frequency		330		kHz	

AEH 24V Input Half-Brick Series Power Converters
2.5V, 3.3V, 5V Single Output, 50-150W

AEH20A24(N) Output Characteristics

Characteristic	Min	Typ	Max	Units	Notes
Power		100		W	
Output Current		20		A	
Output Setpoint Voltage	4.92	5.0	5.08	Vdc	Vin=24V, Io=20A
Line Regulation		0.02	0.2	%Vo	Vin=18~36V, Io=20A
Load Regulation		0.1	0.5	%Vo	Io=0~20A, Vin=24V
Dynamic Response					
50-75% load		1.5		%Vo	Ta=25°C, di/dt =1A/10µs
		100		µs	Ta=25°C, di/dt =1A/10µs
50-25% load		1.5		%Vo	Ta=25°C, di/dt =1A/10µs
		100		µs	Ta=25°C, di/dt =1A/10µs
Current Limit Threshold	22	24.5	28	A	
Short Circuit Current		30		A	
Efficiency	86	88		%	Vin=24V, Io=20A
Trim Range	90		110	%Vo	
Over Voltage Protection Setpoint	5.75		7.0	V	
Sense Compensation			0.5	V	0.25V each leg
Temperature Regulation			0.02	%Vo/°C	
Ripple (rms)		20	40	mV	(0 to 20MHz Bandwidth)
Noise (pp)		100	150	mV	(0 to 20MHz Bandwidth)
Over Temperature Protection		105		°C	
Switching Frequency		280		kHz	

Characteristic Curves (at 25 °C)

Typical Efficiency AEH10G24N

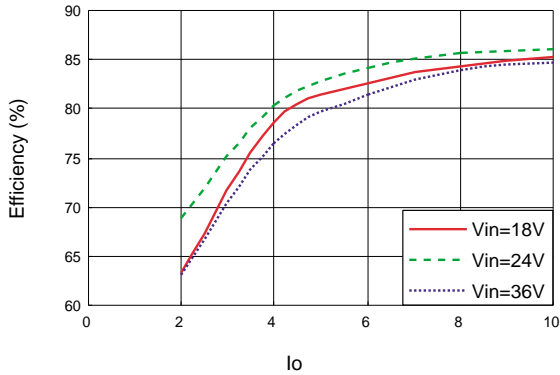

Typical Efficiency AEH10F24N

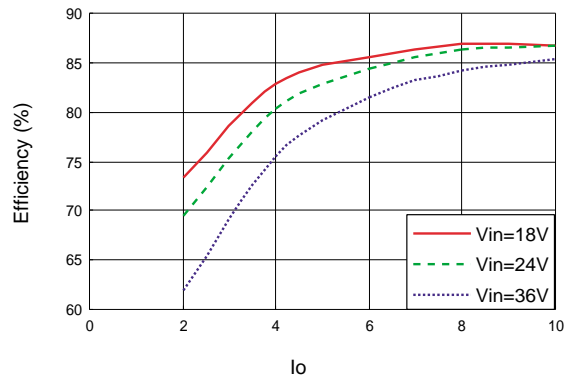

Typical Efficiency AEH10A24N

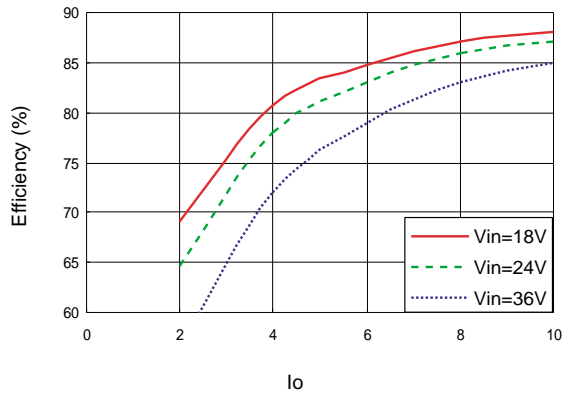

Typical Efficiency AEH20G24N

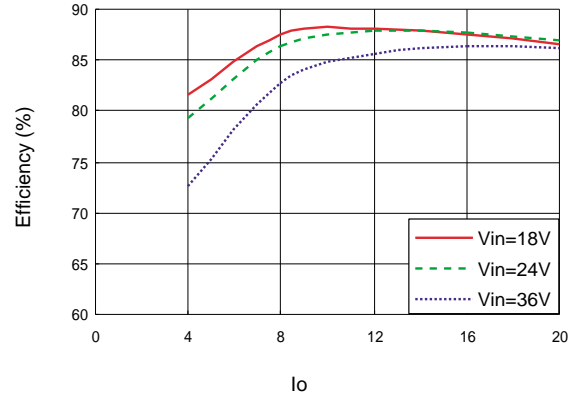

Typical Efficiency AEH20F24N

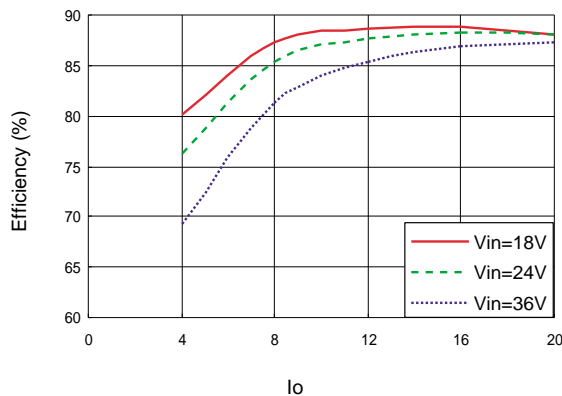

Typical Efficiency AEH20A24N

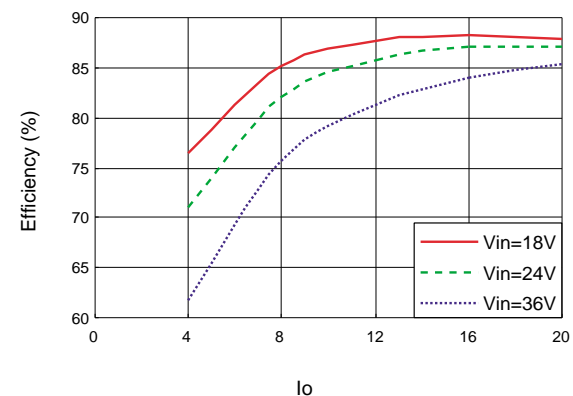

Characteristic Curves (at 25 °C)

Typical Output Overcurrent Characteristics
 AEH10G24N

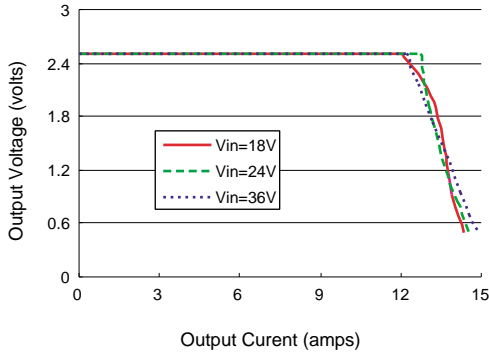

Typical Output Overcurrent Characteristics
 AEH10F24N

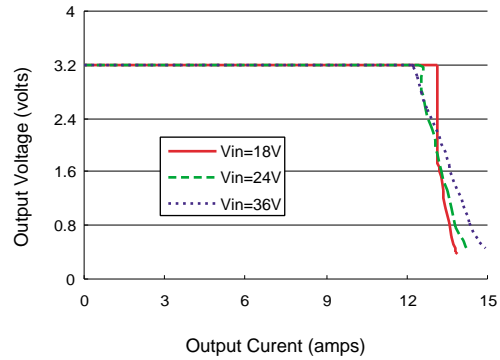

Typical Output Overcurrent Characteristics
 AEH10A24N

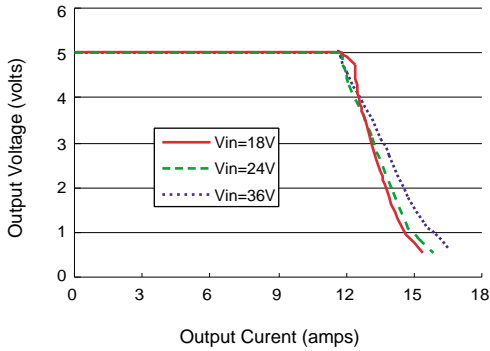

Typical Output Overcurrent Characteristics
 AEH20G24N

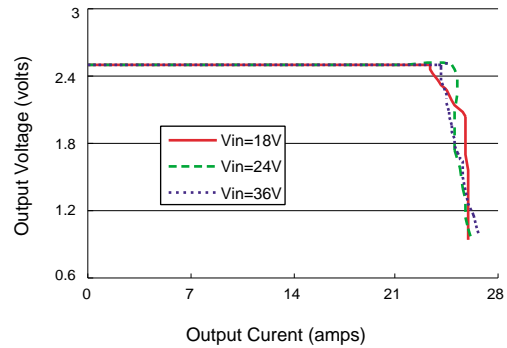

Typical Output Overcurrent Characteristics
 AEH20F24N

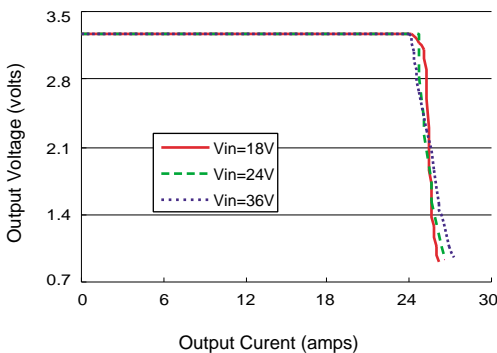

Typical Output Overcurrent Characteristics
 AEH10A24N

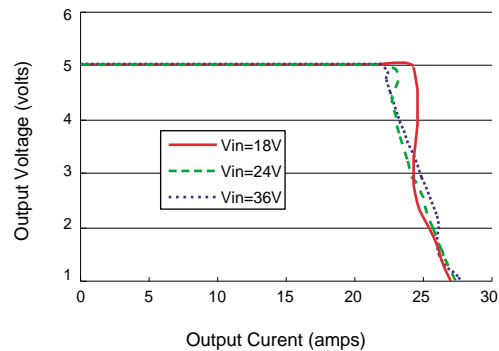

Characteristic Curves (at 25 °C)

**Typical Input-Output Characteristics
AEH10G24N**

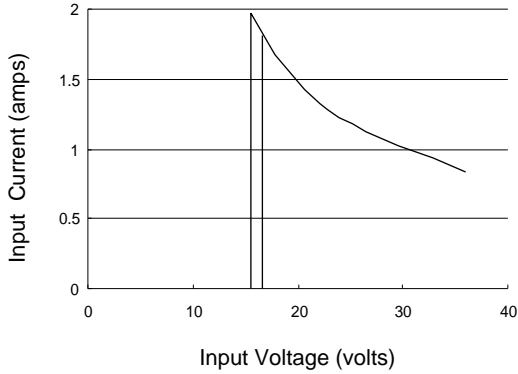

**Typical Input-Output Characteristics
AEH10F24N**

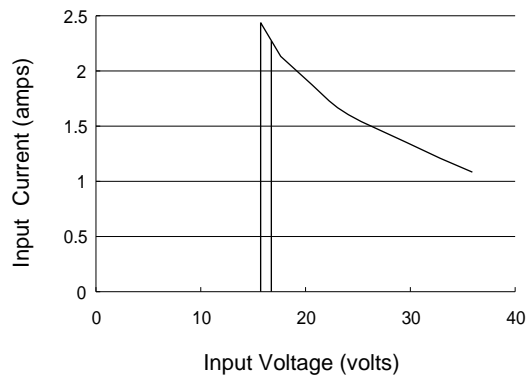

**Typical Input-Output Characteristics
AEH10A24N**

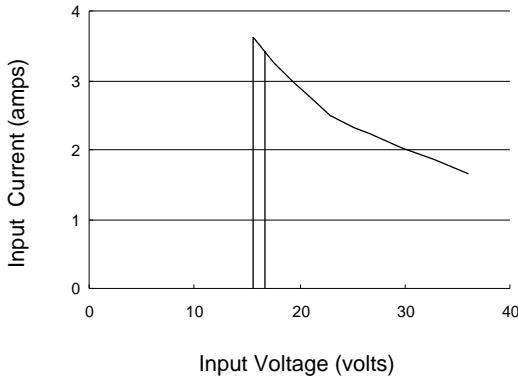

**Typical Input-Output Characteristics
AEH20G24N**

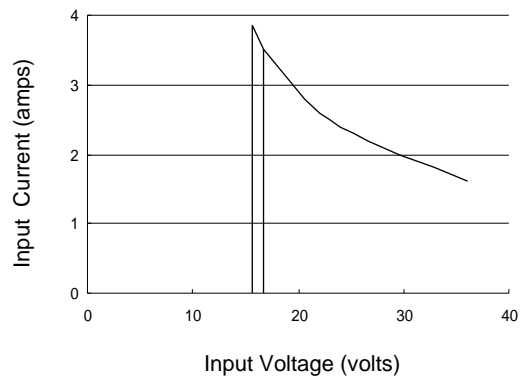

**Typical Input-Output Characteristics
AEH20F24N**

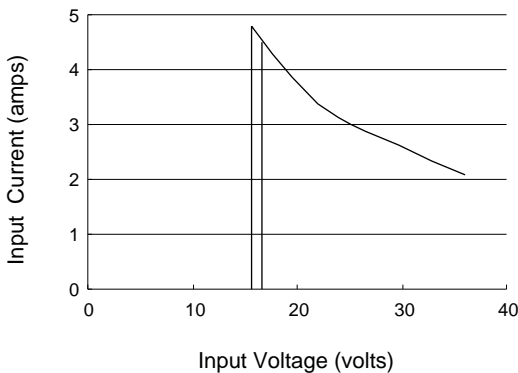

**Typical Input-Output Characteristics
AEH20A24N**

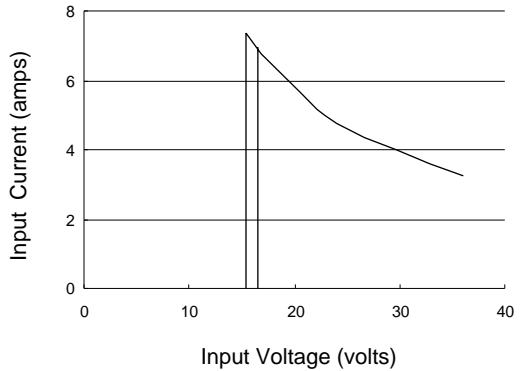

Transient response (24V rated input, variable load, at 25 °C)

**Typical Transient Response to Step Load
Change from 25%-50%-25%I_{omax}
AEH10G24N**

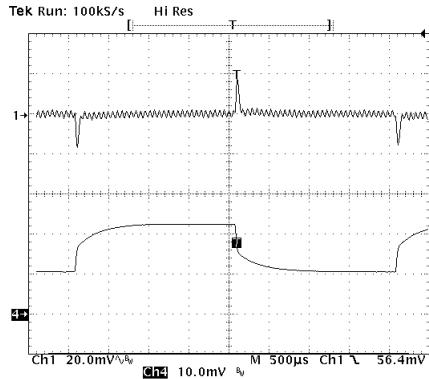

**Typical Transient Response to Step Load
Change from 25%-50%-25%I_{omax}
AEH10F24N**

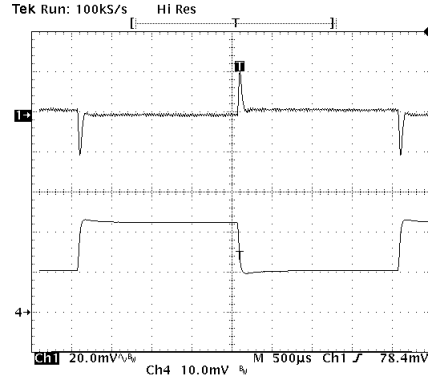

**Typical Transient Response to Step Load
Change from 25%-50%-25%I_{omax}
AEH10A24N**

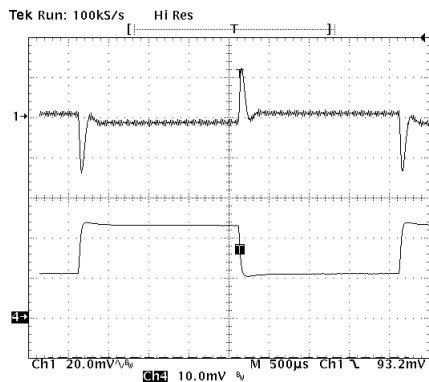

**Typical Transient Response to Step Load
Change from 25%-50%-25%I_{omax}
AEH20G24N**

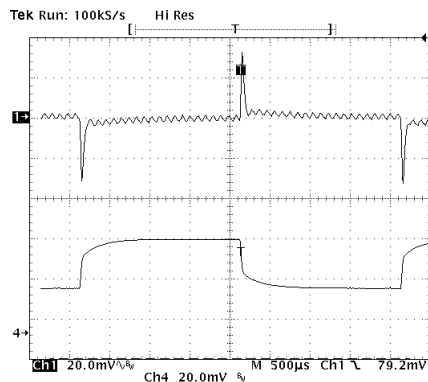

**Typical Transient Response to Step Load
Change from 25%-50%-25%I_{omax}
AEH20F24N**

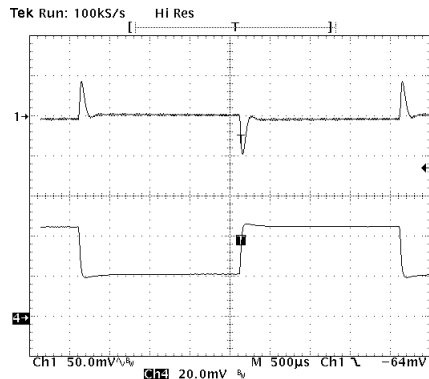

**Typical Transient Response to Step Load
Change from 25%-50%-25%I_{omax}
AEH20A24N**

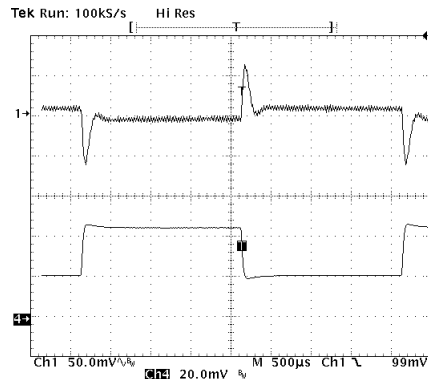

Transient response (24V rated input, variable load, at 25 °C)

Typical Transient Response to Step Load Change from 75%-50%-75%I_{omax}
AEH10G24N

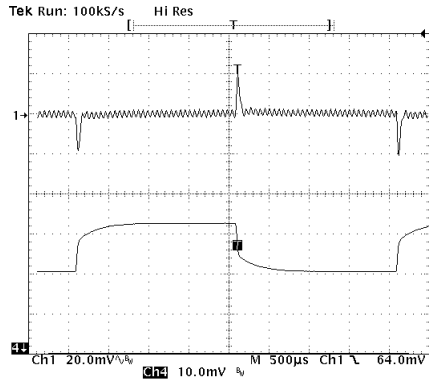

Typical Transient Response to Step Load Change from 75%-50%-75%I_{omax}
AEH10F24N

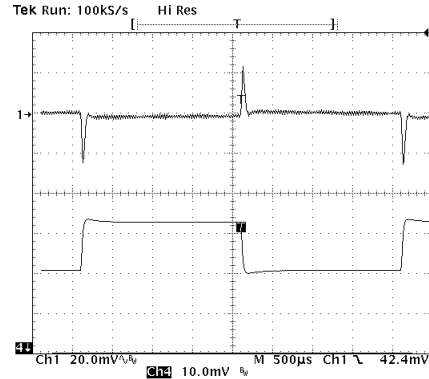

Typical Transient Response to Step Load Change from 75%-50%-75%I_{omax}
AEH10A24N

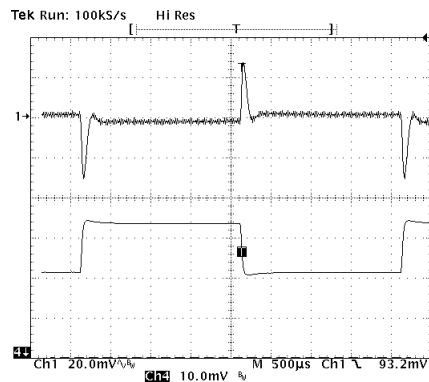

Typical Transient Response to Step Load Change from 50%-75%-50%I_{omax}
AEH20G24N

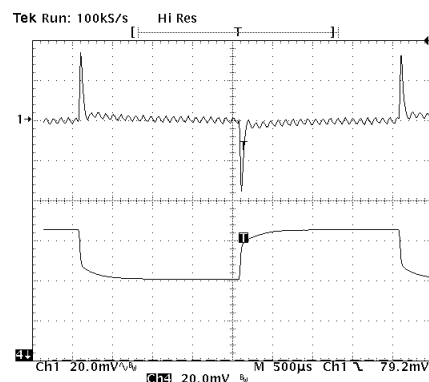

Typical Transient Response to Step Load Change from 50%-75%-50%I_{omax}
AEH20F24N

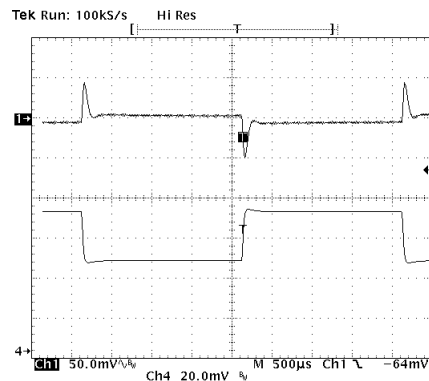

Typical Transient Response to Step Load Change from 75%-50%-75%I_{omax}
AEH20A24N

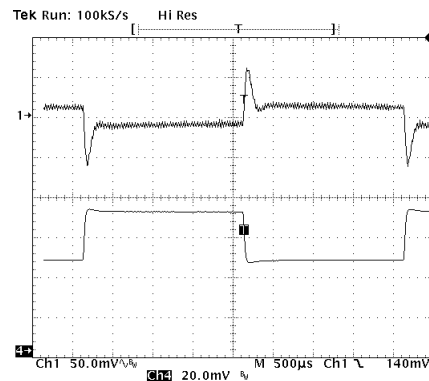

Characteristic Curves (24V rated input voltage, full load, at 25 °C)

Typical Start-Up from Power On
AEH10G24N

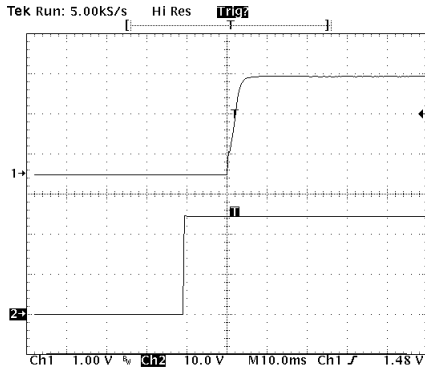

Typical Start-Up from Power On
AEH10F24N

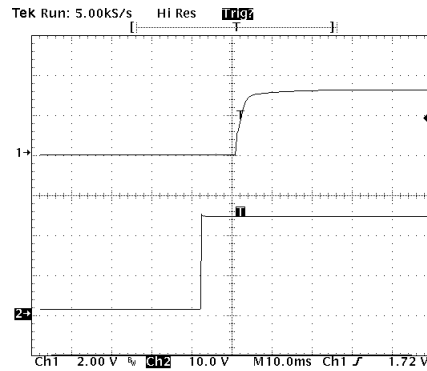

Typical Start-Up from Power On
AEH10A24N

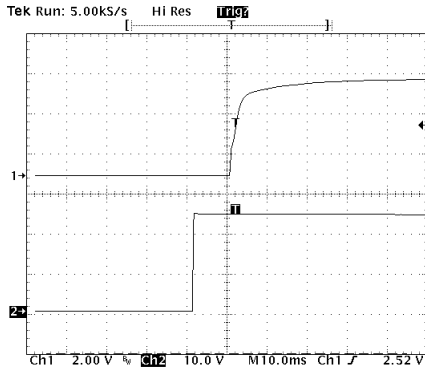

Typical Start-Up from Power On
AEH20G24N

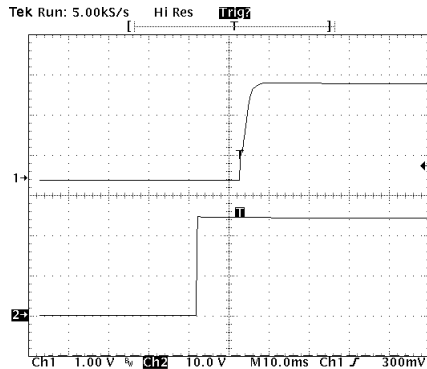

Typical Start-Up from Power On
AEH20F24N

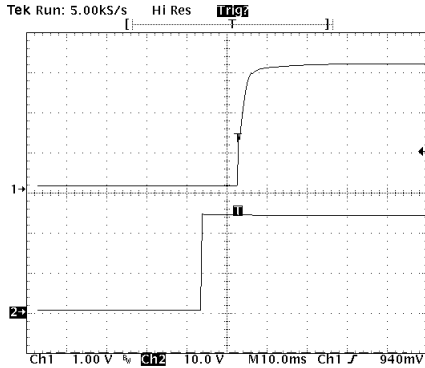

Typical Start-Up from Power On
AEH20A24N

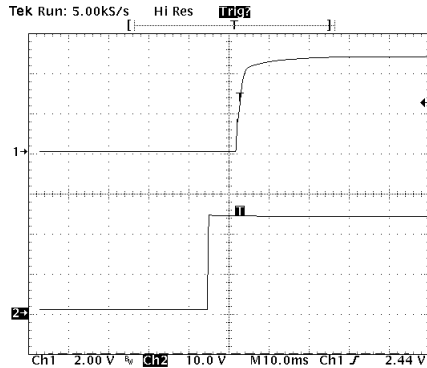

Characteristic Curves (24V rated input voltage, full load, at 25 °C)

Typical Shut-down from Power Off
AEH10G24N

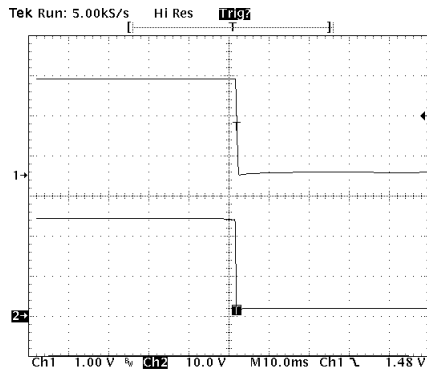

Typical Shut-down from Power Off
AEH10F24N

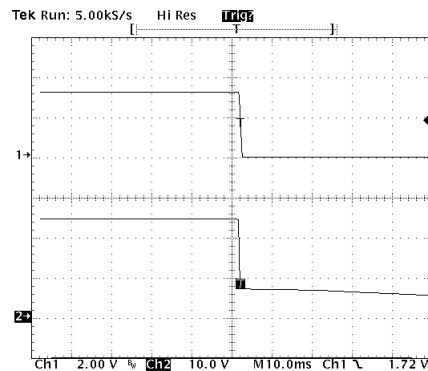

Typical Shut-down from Power Off
AEH10A24N

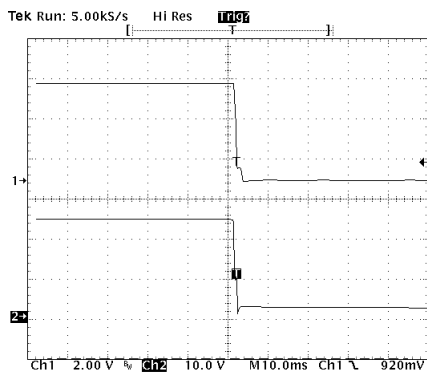

Typical Shut-down from Power Off
AEH20G24N

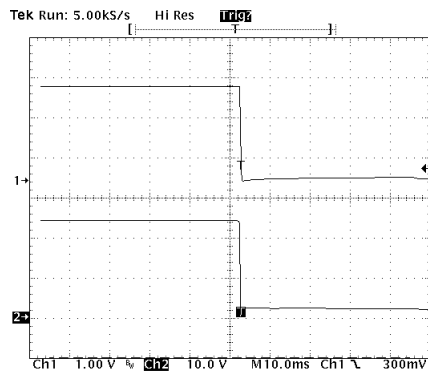

Typical Shut-down from Power Off
AEH20F24N

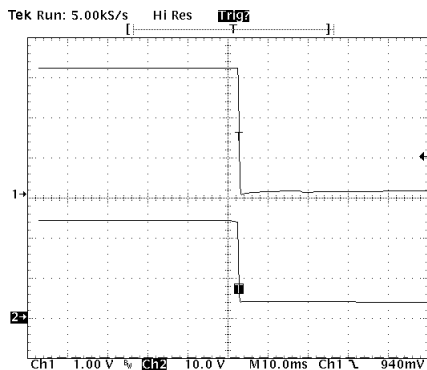

Typical Shut-down from Power Off
AEH20A24N

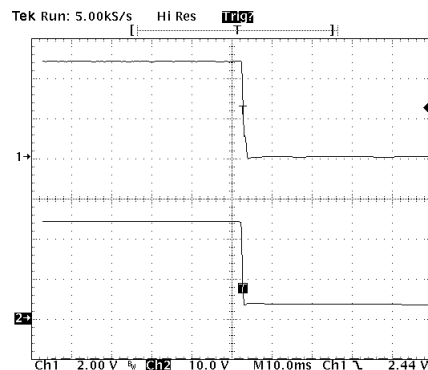

Characteristic Curves (24V rated input voltage, full load, at 25 °C)

Typical Start-Up Transient with CNT Control
AEH10G24N

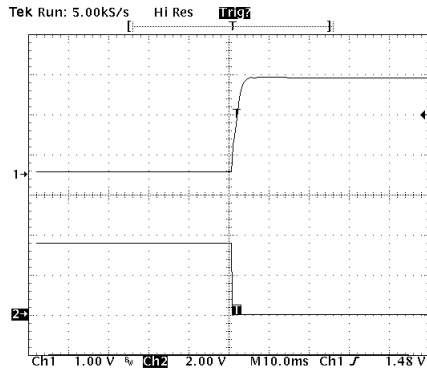

Typical Start-Up Transient with CNT Control
AEH10F24N

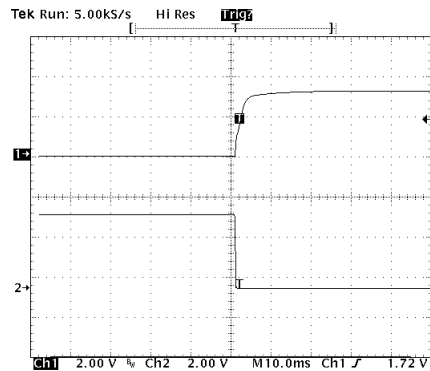

Typical Start-Up Transient with CNT Control
AEH10A24N

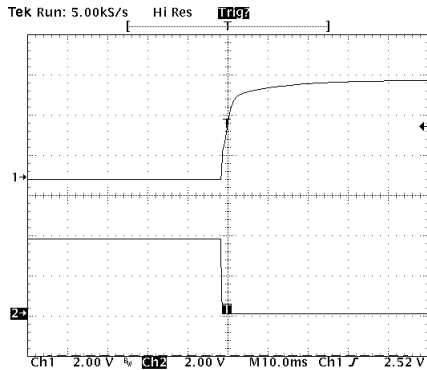

Typical Start-Up Transient with CNT Control
AEH20G24N

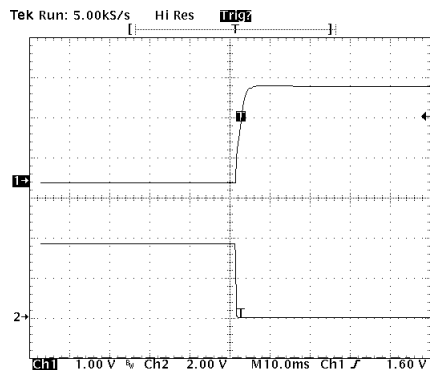

Typical Start-Up Transient with CNT Control
AEH20F24N

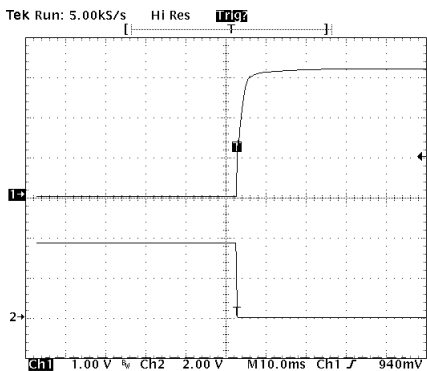

Typical Start-Up Transient with CNT Control
AEH20A24N

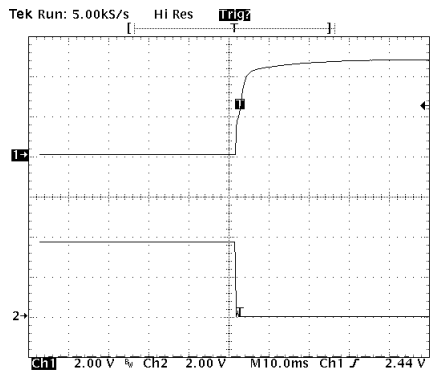

Characteristic Curves (24V rated input voltage, full load, at 25 °C)

Typical Shut-down Transient with CNT Control
AEH10G24N

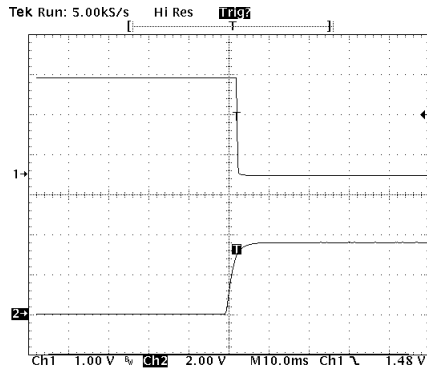

Typical Shut-down Transient with CNT Control
AEH10F24N

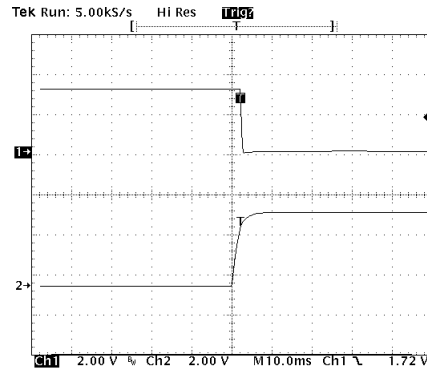

Typical Shut-down Transient with CNT Control
AEH10A24N

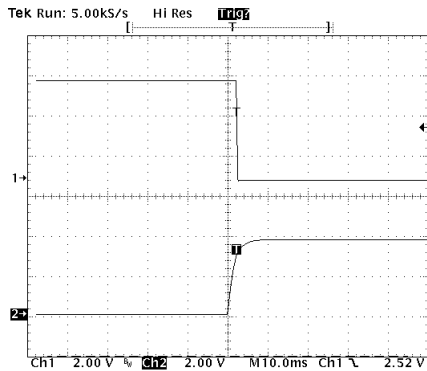

Typical Shut-down Transient with CNT Control
AEH20G24N

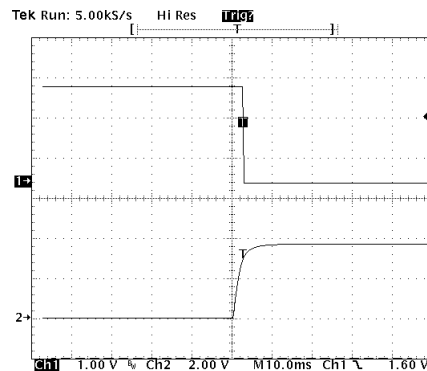

Typical Shut-down Transient with CNT Control
AEH20F24N

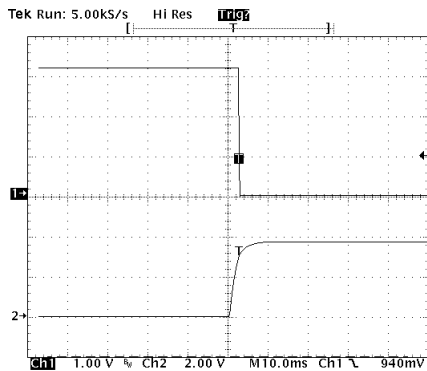

Typical Shut-down Transient with CNT Control
AEH20A24N

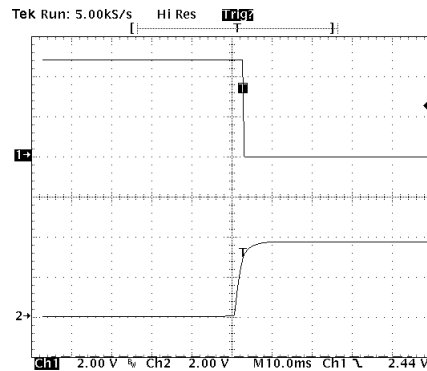

**AEH 24V Input Half-Brick Series Power Converters
2.5V, 3.3V, 5V Single Output, 50-150W**

Characteristic Curves (24V rated input voltage, full load, at 25 °C)

**Typical Output Ripple Voltage
AEH10G24N**

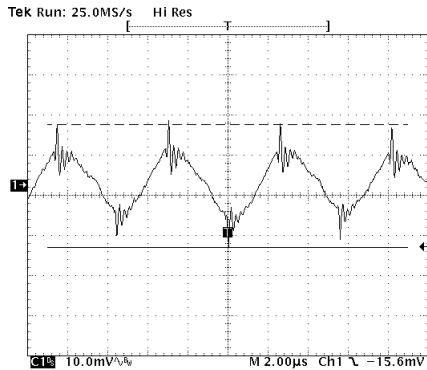

**Typical Output Ripple Voltage
AEH10F24N**

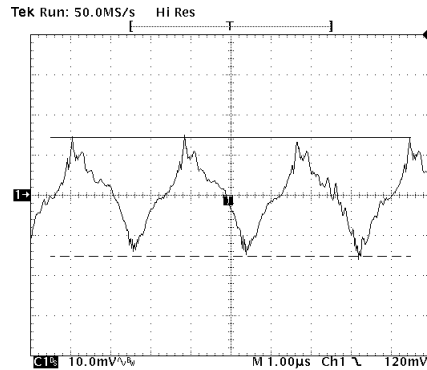

**Typical Output Ripple Voltage
AEH10A24N**

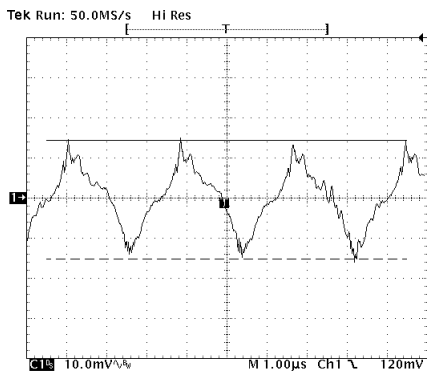

**Typical Output Ripple Voltage
AEH20G24N**

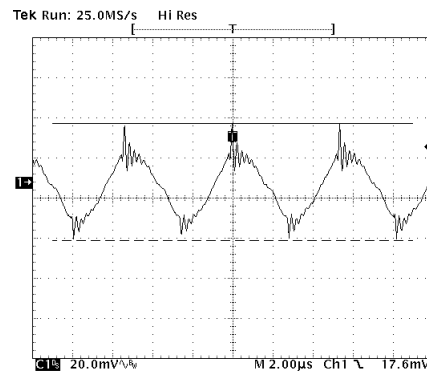

**Typical Output Ripple Voltage
AEH20F24N**

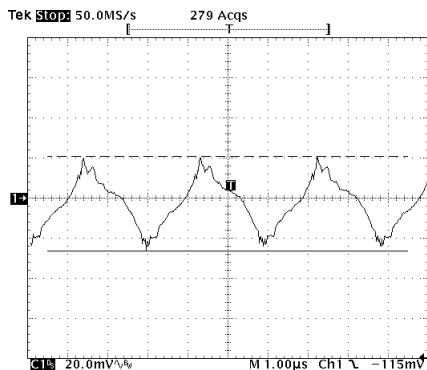

**Typical Output Ripple Voltage
AEH20A24N**

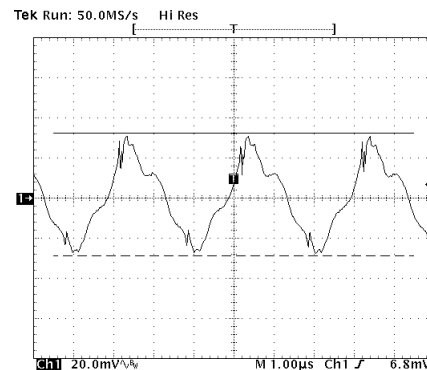

AEH 24V Input Half-Brick Series Power Converters
2.5V, 3.3V, 5V Single Output, 50-150W

Characteristic Curves *(24V rated input voltage, full load, at 25 °C)*

Overvoltage Protection
AEH10G24N

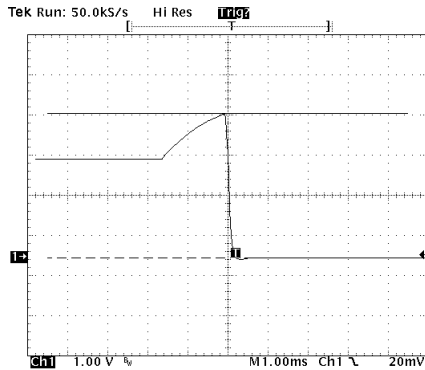

Overvoltage Protection
AEH10F24N

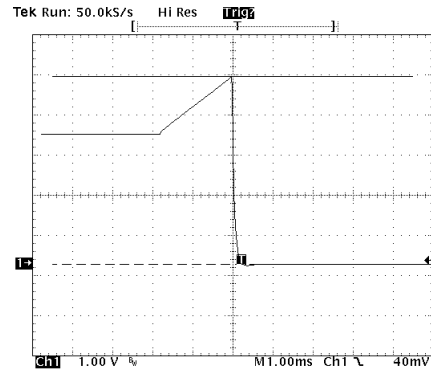

Overvoltage Protection
AEH10A24N

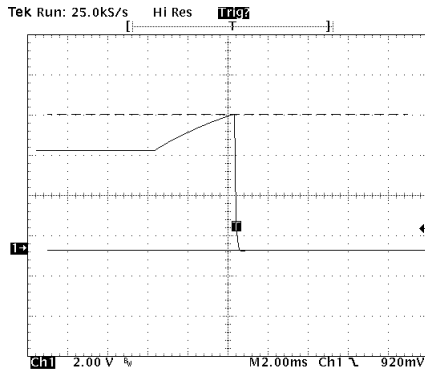

Overvoltage Protection
AEH20G24N

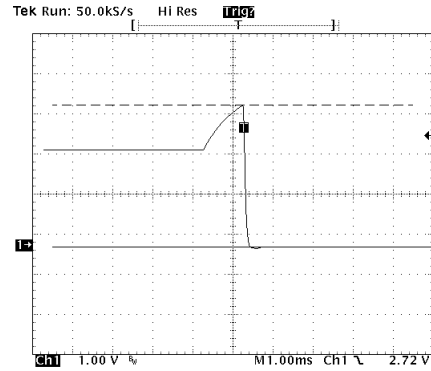

Overvoltage Protection
AEH20F24N

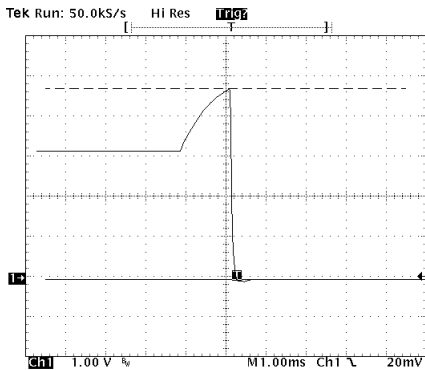

Overvoltage Protection
AEH20A24N

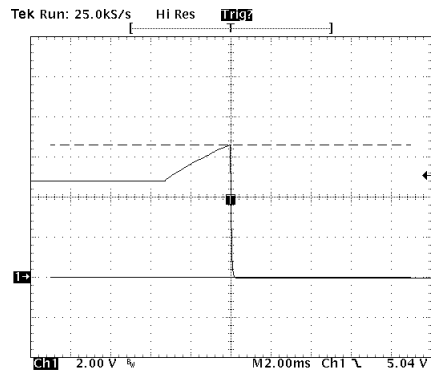

Pins

The +Vin and -Vin input connection pins are located as shown in Figure 1. AEH 24Vin converters have a 2:1 input voltage range and can accept 18-36 Vdc.

Care should be taken to avoid applying reverse polarity to the input which can damage the converter.

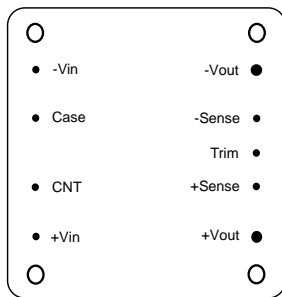

Fig.1 Pin Location

Input Characteristic

Fusing

The AEH 24Vin power modules have no internal fuse. An external fuse must always be employed! To meet international safety requirements, a 250 Volt rated fuse should be used. If one of the input lines is connected to chassis ground, then the fuse must be placed in the other input line.

Standard safety agency regulations require input fusing. Recommended fuse ratings for the AEH 24Vin Series are shown in Table 1.

Table 1

Series	Fuse Rating(24Vin)
50W	10A
75W	15A
100W	20A
150W	30A

Input Reverse Voltage Protection

Under installation and cabling conditions where reverse polarity across the input may occur, reverse polarity protection is recommended. Protection can easily be provided as shown in Figure 2. In both cases the diode rating is determined by the power of the converter. Diodes should be rated as shown in Table1.

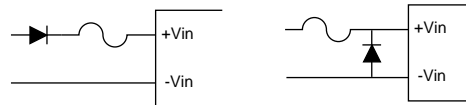

Fig.2 Reverse Polarity Protection Circuits

Placing the diode across the inputs rather than in-line with the input offers an advantage in that the diode only conducts in a reverse polarity condition, which increases circuit efficiency and thermal performance.

Input Undervoltage Protection

The AEH 24Vin series is protected against undervoltage on the input. If the input voltage drops below the acceptable range, the converter will shut down. It will automatically restart when the undervoltage condition is removed.

Input Filter

Input filters are included in the converters to help achieve standard system emissions certifications. Some users however, may find that additional input filtering is necessary. The AEH 24Vin 2.5Vout series has an internal switching frequency of 180kHz so a high frequency capacitor mounted close to the input terminals produces the best results. To reduce reflected noise, a capacitor can be added across the input as shown in Figure 3, forming a π filter. A 100 μ F/63V electrolytic capacitor is recommended for C1.

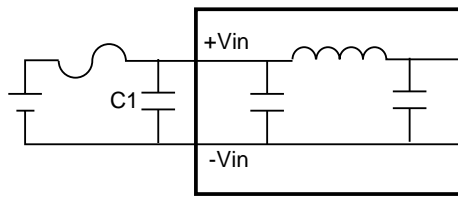

Fig.3 Ripple Rejection Input Filter

For conditions where EMI is a concern, a different input filter can be used. Figure 4 shows an input filter designed to reduce EMI effects. L1, L2 is a 2mH common mode choke.

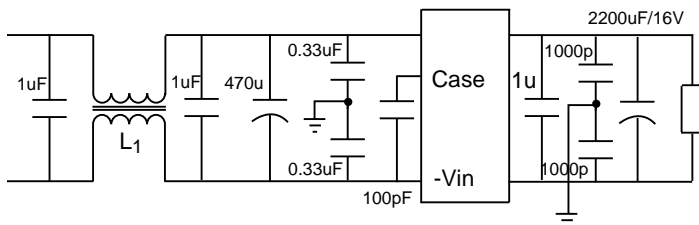

Fig.4 EMI Reduction Input Filter

When a filter inductor is connected in series with the power converter input, an input capacitor C1 should be added. An input capacitor C1 should also be used when the input wiring is long, since the wiring can act as an inductor. Failure to use an input capacitor under these conditions can produce large input voltage spikes and an unstable output.

CNT Function

Two remote on/off options are available.

Negative logic applying a voltage less than 1.2V to the CNT pin will enable the output, and applying a voltage greater than 3V will disable it.

Positive logic applying a voltage larger than 3V to the CNT pin will enable the output, and applying a voltage less than 1.2V will disable it. Negative logic, device code suffix " N ". Positive logic, device code suffix nothing is the factory-preferred.

If the CNT pin is left open, the converter will default to " control off " operation in negative logic, but default to " control on " in positive logic.

The maximum voltage that can be applied to the CNT pin is 15V.

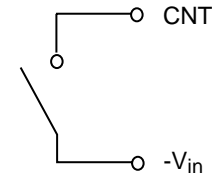

Fig.5 Simple Control

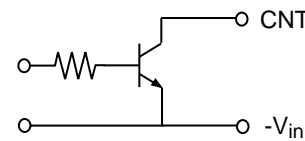

Fig.6 Transistor Control

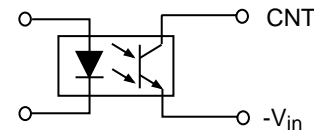

Fig.7 Isolated Control

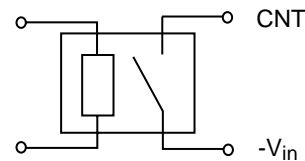

Fig.8 Relay Control

Input-Output Characteristic

Safety Consideration

For safety-agency approval of the system in which the power module is used, the power module must be installed in compliance with the spacing and separation requirements of the end-use safety agency standard, i.e., UL1950, CSA C22.2 No. 950-95, and EN60950.

The input-to-output 1500VDC isolation is an operational insulation. The DC/DC power mod-

ule should be installed in end-use equipment, in compliance with the requirements of the ultimate application, and is intended to be supplied by an isolated secondary circuit. When the supply to the DC/DC power module meets all the requirements for SELV(<60Vdc), the output is considered to remain within SELV limits (level 3). If connected to a non-SELV power system, double or reinforced insulation must be provided in the power supply that isolates the input from any hazardous voltages, including the ac mains. One Vi pin and one Vo pin are to be grounded or both the input and output pins are to be kept floating. Single fault testing in the power supply must be performed in combination with the DC/DC power module to demonstrate that the output meets the requirement for SELV. The input pins of the module are not operator accessible.

Note: Do not ground either of the input pins of the module, without grounding one of the output pins. This may allow a non-SELV voltage to appear between the output pin and ground.

Case Grounding

For proper operation of the module, the case or baseplate of the AEH 24Vin module does not require a connection to a chassis ground. If the AEH module is not in a metallic enclosure in a system, it may be advisable to directly ground the case to reduce electric field emissions. Leaving the case floating can help to reduce magnetic field radiation from common mode noise currents. If the case has to be grounded for safety or other reasons, an inductor can be connected to chassis at DC and AC line frequencies, but be left floating at switching frequencies. Under this condition, the safety requirements are met and the emissions are minimized.

Output Characteristic

Minimum Load Requirement

There no minimum load requirement for the AEH 24Vin series modules.

Remote Sensing

The AEH 24Vin converter can remotely sense both lines of its output which moves the effective output voltage regulation point from the output of the unit to the point of connection of the remote sense pins. This feature automatically adjusts the real output voltage of the AEH 24Vin in order to compensate for voltage drops in distribution and maintain a regulated voltage at the point of load.

When the converter is supporting loads far away, or is used with undersized cabling, significant voltage drop can occur at the load. The best defense against such drops is to locate the load close to the converter and to ensure adequately sized cabling is used. When this is not possible, the converter can compensate for a drop of up to 0.5V, through use of the sense leads.

When used, the + and - sense leads should be connected from the converter to the point of load as shown in Figure 9 using twisted pair wire. The converter will then regulate its output voltage at the point where the leads are connected. Care should be taken not to reverse the sense leads. If reversed, the converter will trigger the OVP protection and turn off. **When not used, the +Sense lead must be connected with +Vo directly, and -Sense with -Vo.** Also note that the output voltage and the remote sense voltage offset must be less than the min-

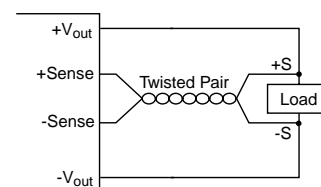

Fig.9 Sense Connections

AEH 24V Input Half-Brick Series Power Converters 2.5V, 3.3V, 5V Single Output, 50-150W

imum overvoltage trip point. **Note that at elevated output voltages the maximum power rating of the module remains the same, and the output current capability will decrease correspondingly.**

Output Trimming

Users can increase or decrease the output voltage set point of a module by connecting an external resistor between the TRIM pin and either the SENSE (+) or SENSE (-) pins. The trim resistor should be positioned close to the module. **If not using the trim feature, leave the TRIM pin open.**

Trimming up by more than 10% of the nominal output may damage the converter or trig the OVP protection. Trimming down more than 10% can cause the converter to regulate improperly. Trim down and trim up circuits and the corresponding configuration are shown in Figure 10 to Figure 15 next page.

Note that at elevated output voltages the maximum power rating of the module remains the same, and the output current capability will decrease correspondingly.

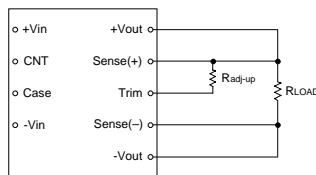

$$R_{adj-up} = \frac{Vo(100+y)}{1.26y} - \frac{(100+2y)}{y}$$

Where y is the adjusting percentage of the voltage.
0 < y < 10
Radj-up is in kΩ.

Fig.10 Circuit and Equation to Trim Up

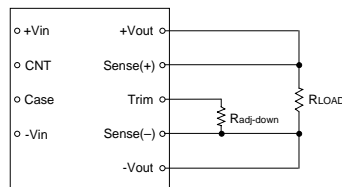

$$R_{adj-down} = \frac{100}{y} - 2$$

where y is the adjusting percentage of the voltage.
0 < y < 10
Radj-down is in kΩ.

Fig.11 Circuit and Equation to Trim Down

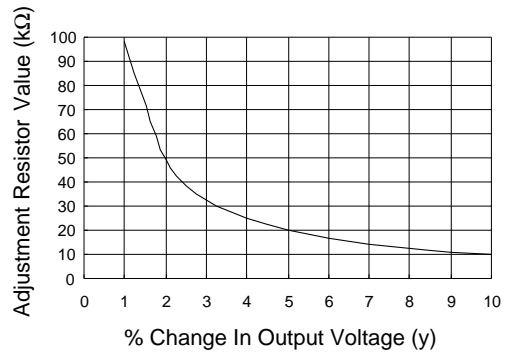

Fig.12 Resistor Selection for 2.5Vout Trim Up

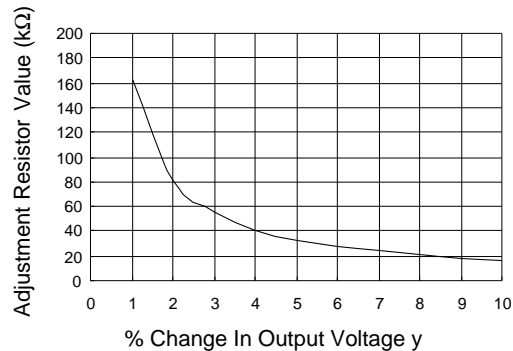

Fig.13 Resistor Selection for 3.3Vout Trim Up

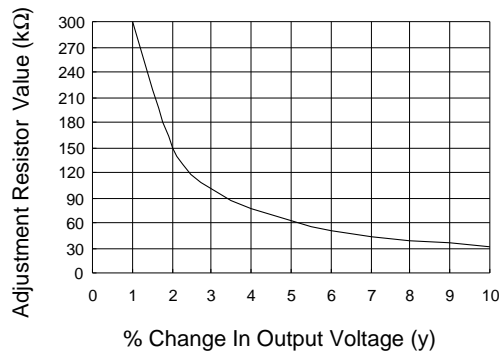

Fig.14 Resistor Selection for 5Vout Trim Up

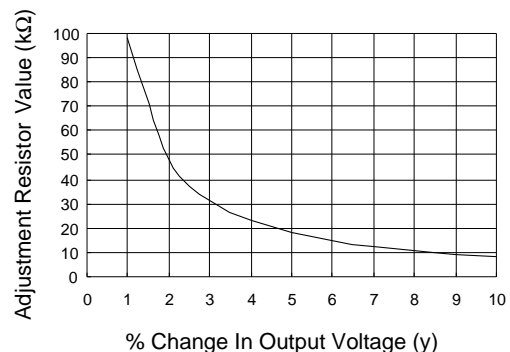

Fig.15 Resistor Selection for Trim Down

Output Over-Current Protection

AEH 24Vin series DC/DC converters feature foldback current limiting as part of their Overcurrent Protection (OCP) circuits. When output current exceeds 110 to 140% of rated current, such as during a short circuit condition, the output will shutdown immediately, and can tolerate short circuit conditions indefinitely. When the overcurrent condition is removed, the converter will automatically restart.

Output Filters

When the load is sensitive to ripple and noise, an output filter can be added to minimize the effects. A simple output filter to reduce output ripple and noise can be made by connecting a capacitor across the output as shown in Figure 16. The recommended value for the output capacitor C1 is 2200 μ F/10V.

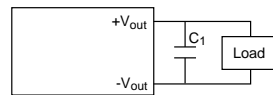

Fig.16 Output Ripple Filter

Extra care should be taken when long leads or traces are used to provide power to the load. Long lead lengths increase the chance for noise to appear on the lines. Under these conditions C2 can be added across the load as shown in Figure 17. The recommended component for C2 is 2200 μ F/10V capacitor and connecting a 0.1 μ F ceramic capacitor C1 in parallel generally.

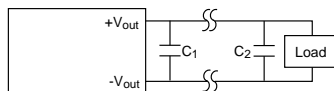

Fig.17 Output Ripple Filter For a Distant Load

Decoupling

Noise on the power distribution system is not always created by the converter. High speed

analog or digital loads with dynamic power demands can cause noise to cross the power inductor back onto the input lines. Noise can be reduced by decoupling the load. In most cases, connecting a 10 μ F tantalum capacitor in parallel with a 0.1 μ F ceramic capacitor across the load will decouple it. The capacitors should be connected as close to the load as possible.

Ground Loops

Ground loops occur when different circuits are given multiple paths to common or earth ground, as shown in Figure 18. Multiple ground points can slightly different potential and cause current flow through the circuit from one point to another. This can result in additional noise in all the circuits. To eliminate the problem, circuits should be designed with a single ground connection as shown in Figure 19.

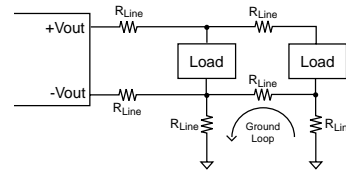

Fig.18 Ground Loops

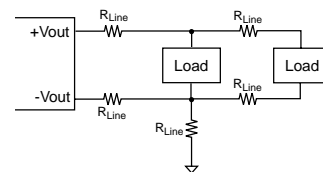

Fig.19 Single Point Ground

Output Over-Voltage Protection

The over-voltage protection has a separate feedback loop which activates when the output voltage is between 120% and 140% of the nominal output voltage. When an over-voltage condition occurs, a “ turn off “ signal was sent to the input of the module, and shut off the output. The module will restart after power on again.

AEH 24V Input Half-Brick Series Power Converters 2.5V, 3.3V, 5V Single Output, 50-150W

Parallel Power Distribution

Figure 20 shows a typical parallel power distribution design. Such designs, sometimes called daisy chains, can be used for very low output currents, but are not normally recommended. The voltage across loads far from the source can vary greatly depending on the IR drops along the leads and changes in the loads closer to the source. Dynamic load conditions increase the potential problems.

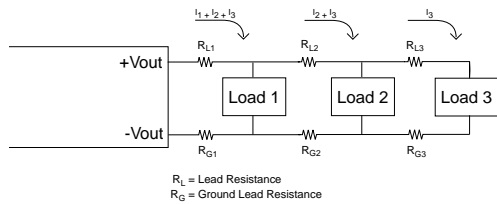

Fig.20 Parallel Power Distribution

Radial Power Distribution

Radial power distribution is the preferred method of providing power to the load. Figure 21 shows how individual loads are connected directly to the power source. This arrangement requires additional power leads, but it avoids the voltage variation problems associated with the parallel power distribution technique.

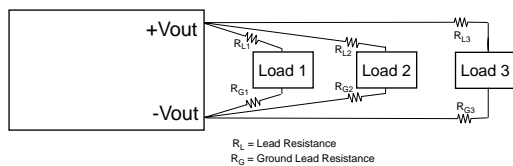

Fig.21 Radial Power Distribution

Mixed Distribution

In the real world a combination of parallel and radial power distribution is often used. Dynamic and high current loads are connected using a radial design, while static and low current loads can be connected in parallel. This combined approach minimizes the drawbacks of a parallel

design when a purely radial design is not feasible.

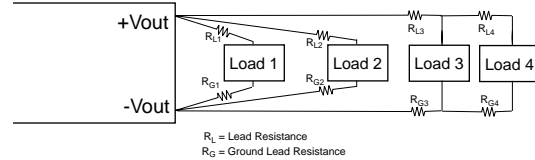

Fig.22 Mixed Power Distribution

Redundant Operation

A common requirement in high reliability systems is to provide redundant power supplies. The easiest way to do this is to place two converters in parallel, providing fault tolerance but not load sharing. Oring diodes should be used to ensure that failure of one converter will not cause failure of the second. Figure 23 shows such an arrangement. Upon application of power, one of the converters will provide a slightly higher output voltage and will support the full load demand. The second converter will see a zero load condition and will "idle". If the first converter should fail, the second converter will support the full load. When designing redundant converter circuits, Schottky diodes should be used to minimize the forward voltage drop. The voltage drop across the Schottky diodes must also be considered when determining load voltage requirements.

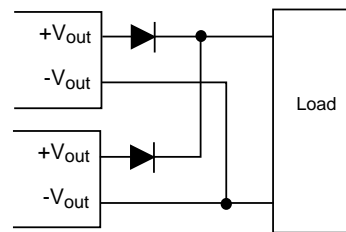

Fig.23 Redundant Operation

Thermal Management

Technologies

AEH 24V input series features high efficiency and the module have typical efficiency high up to 88% at full load. With less heat dissipation and temperature-resistant components such as ceramic capacitors, these modules exhibit good behavior during prolonged exposure to high temperatures. Maintaining the operating case temperature (T_c) within the specified range help keep internal-component temperatures within their specifications which in turn help keep MTBF from falling below the specified rating. Proper cooling of the power modules is also necessary for reliable and consistent operation.

Basic Thermal Management

Measuring the case temperature of the module (T_c) as the method shown in Figure 24 can verify the proper cooling. Figure 24 shows the metal surface of the module and the pin locations. The module should work under 90°C for the reliability of operation and T_c must not exceed 100 °C while operating in the final system configuration. The measurement can be made with a surface probe after the module has reached thermal equilibrium. If a heat sink is mounted to the case, make the measurement as close as possible to the indicated position. It makes the assumption that the final system configuration exists and can be used for a test environment.

The following text and graphs show guidelines to predict the thermal performance of the module for typical configurations that include heat sinks in natural or forced airflow environments. Note that T_c of module must always be checked in the final system configuration to verify proper operational due to the variation in test condi-

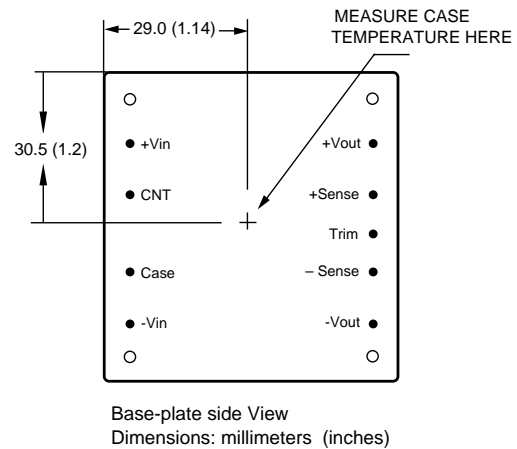

Fig.24. Case Temperature Measurement

tions.

Thermal management acts to transfer the heat dissipated by the module to the surrounding environment. The amount of power dissipated by the module as heat (P_D) is got by the equation below:

$$P_D = P_I - P_O$$

where : P_I is input power;

P_O is output power;

P_D is dissipated power.

Also, module efficiency (η) is defined as the following equation:

$$\eta = P_O / P_I$$

If eliminating the input power term, from two above equations can yield the equation below:

$$P_D = P_O (1 - \eta) / \eta$$

The module power dissipation then can be calculated through the equation.

Because each power module output voltage has a different power dissipation curve, a plot of power dissipation versus output current over three different line voltages is given in each module-specific data sheet. The typical power dissipation curve of AEH series are shown as figure 25 to figure 30.

AEH 24V Input Half-Brick Series Power Converters
2.5V, 3.3V, 5V Single Output, 50-150W

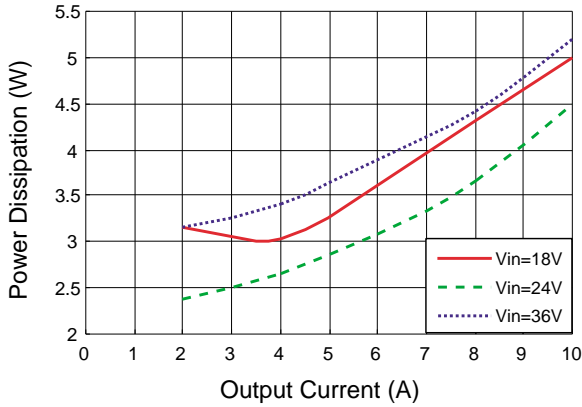

Fig.25 AEH10G24N Power Dissipation Curves

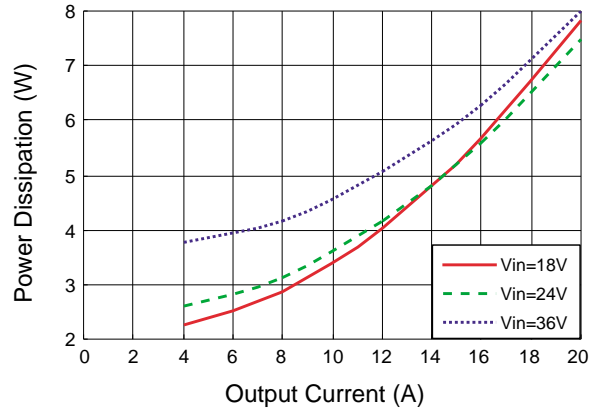

Fig.28 AEH10F24N Power Dissipation Curves

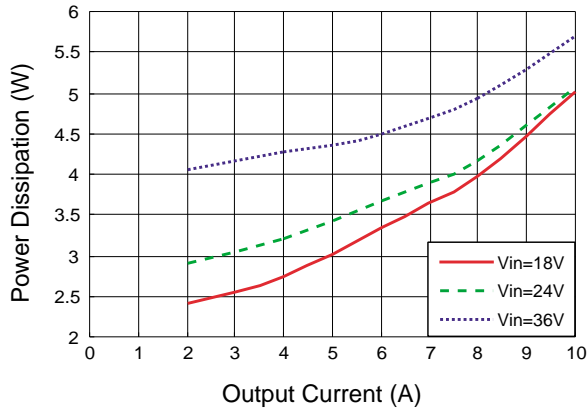

Fig.26 AEH10A24N Power Dissipation Curves

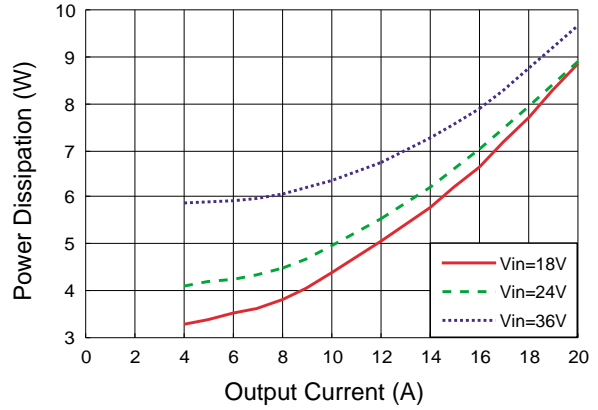

Fig.29 AEH20G24N Power Dissipation Curves

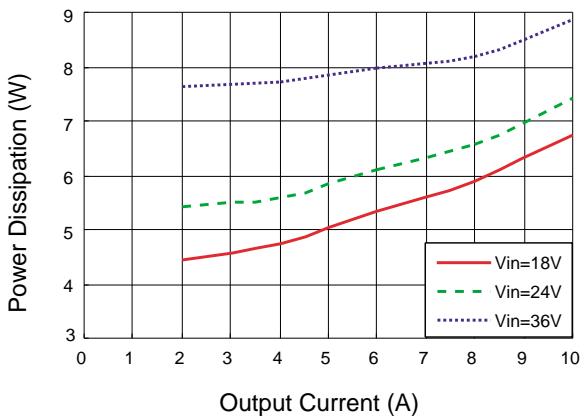

Fig.27 AEH20F24N Power Dissipation Curves

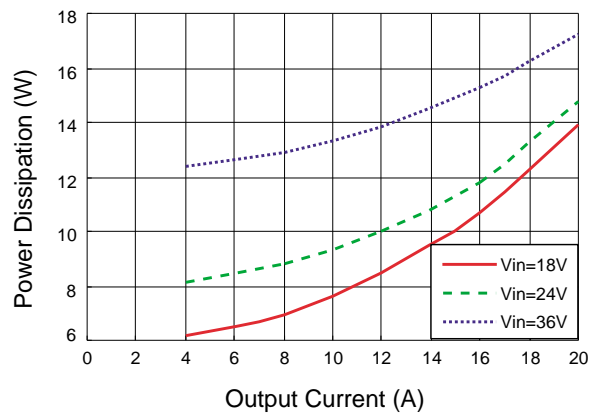

Fig.30 AEH20A24N Power Dissipation Curves

Module Derating

Experiment Setup

From the experimental set up shown in figure 31, the derating curves as figure 32 can be drawn. Note that the PWB (printed-wiring board) and the module must be mounted vertically. The passage has a rectangular cross-section. The clearance between the facing PWB and the top of the module is kept 13 mm (0.5 in.) constantly.

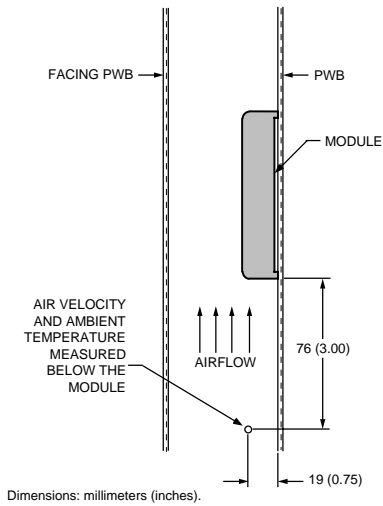

Fig.31 Experiment Set Up

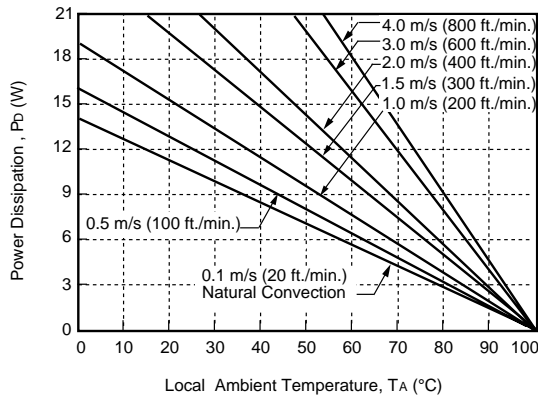

Fig.32 Forced Convection Power Derating without Heat Sink

Convection Without Heat Sinks

Heat transfer can be enhanced by increasing the airflow over the module. Figure 32 shows the maximum power that can be dissipated by the module.

In the test, natural convection airflow was measured at 0.05 m/s to 0.1 m/s (10 ft./min. to 20 ft./min.). The 0.5 m/s to 4.0 m/s (100 ft./min. to 800 ft./min.) curves are tested with externally adjustable fans. The appropriate airflow for a given operating condition can be determined through figure 32.

Example 1. How to calculate the minimum airflow required to maintain a desired Tc?

If a AEH20A24N module operates with a 24V line voltage, a 20 A output current, and a 40 °C maximum ambient temperature, What is the minimum airflow necessary for the operating?

Determine Pd (referenced Fig.30) with condition:

$$V_{in} = 24 \text{ V}$$

$$I_o = 20 \text{ A}$$

Get: $P_D = 15 \text{ W}$

And with $T_A = 40 \text{ }^\circ\text{C}$

Determine airflow (Fig.32):

$$v = 1.5 \text{ m/s (300 ft./min.)}$$

Example 2. How to calculate the maximum output power of a module in a certain convection and a max. TA?

What is the maximum power output for a AEH20A24N operating at following conditions:

$$V_{in} = 24 \text{ V}$$

$$v = 1.5 \text{ m/s (300 ft./min.)}$$

$$T_A = 40 \text{ }^\circ\text{C}$$

Determine Pd (Fig.32)

$$P_D = 15\text{W}$$

Determine Io (Fig.30):

$$I_o = 20 \text{ A}$$

Calculate Po:

AEH 24V Input Half-Brick Series Power Converters 2.5V, 3.3V, 5V Single Output, 50-150W

$$P_o = (V_o) \times (I_o) = 5 \times 20 = 100 \text{ W}$$

Although the two examples above use 100 °C as the maximum case temperature, for extremely high reliability applications, one may design to a lower case temperature as shown in Example 4 on page 35.

Heat Sink Configuration

Several standard heat sinks are available for the AEH 24Vin 50 W to 150 W modules as shown in Figure 33 to Figure 35.

The heat sinks mount to the top surface of the

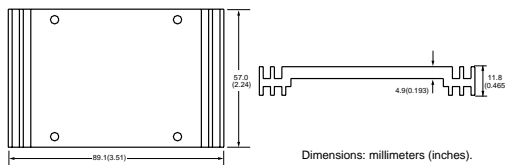

Fig.33 Non Standard Heatsink

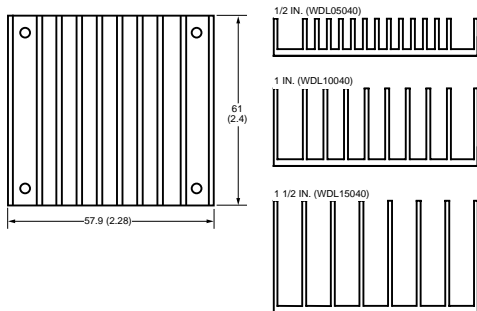

Fig.34 Longitudinal Fins Heat Sink

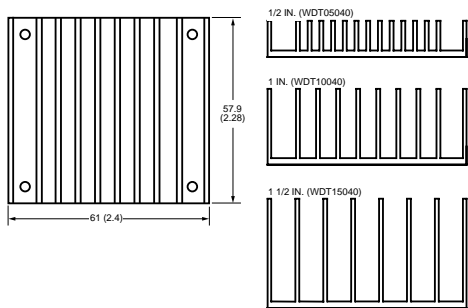

Fig.35 Transverse Fins Heat Sink

module with screws torqued to 0.56 N-m (5 in.-lb). A thermally conductive dry pad or thermal grease is placed between the case and the heat sink to minimize contact resistance (typically 0.1°C/W to 0.3°C/W) and temperature differential.

Nomenclature for heat sink configurations is as follows:

WDxyyy40

where:

x = fin orientation: longitudinal (L) or transverse (T)

yyy = heat sink height (in 100ths of inch)

For example, WDT5040 is a heat sink that is transverse mounted (see Figure 35) for a 61 mm x 57.9 mm (2.4 in.x 2.28 in.) module with a heat sink height of 0.5 in.

Heatsink Mounting Advice

A crucial part of the thermal design strategy is the thermal interface between the baseplate of the module and the heatsink. Inadequate measures taken here will quickly negate any other attempts to control the baseplate temperature. For example, using a conventional dry insulator can result in a case-heatsink thermal impedance of >0.5°C/W, while use one of the recommended interface methods (silicon grease

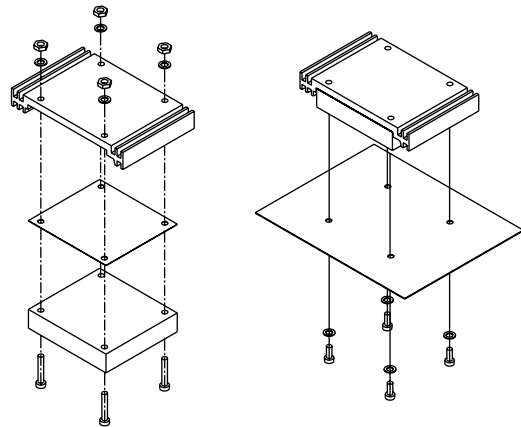

Fig.36 Heat Sink Mounting

**AEH 24V Input Half-Brick Series Power Converters
2.5V, 3.3V, 5V Single Output, 50-150W**

or thermal pads available from Astec) can result in a case-heatsink thermal impedance around 0.1°C/W.

Natural Convection with Heat Sink

The power derating for a module with the heat sinks (shown as figure 25 to figure 30) in natural convection is shown in figure 35. In this test, natural convection generates airflow about 0.05 m/s to 0.1 m/s (10ft./min to 20ft./min). Figure 37 can be used for heat-sink selection in natural convection environment.

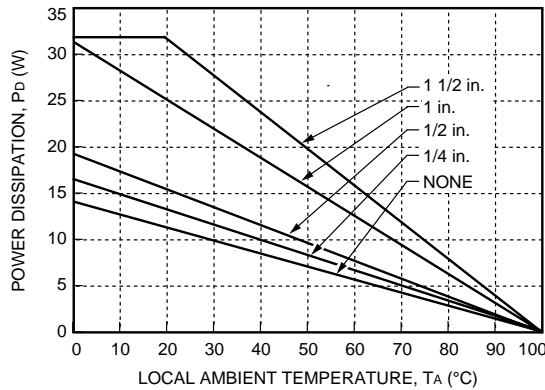

Fig.37 Heat Sink Power Derating Curves, Natural Convection

Example 3. How to select a heat sink?

What heat sink would be appropriate for a AEH20A24N in a natural convection environment at nominal line, 2/3 load, and maximum ambient temperature of 40°C?

Determine Pd (referenced Fig.30) with condition:

$$V_{in} = 24 \text{ V}$$

$$I_o = 2/3 (20) = 13 \text{ A}$$

$$T_A = 40 \text{ }^\circ\text{C}$$

Get: Pd = 10.5 W

Determine Heat Sink (Fig.37):

no heat sink allows up to TA = 30 °C
1/4 in. allows up to TA = 40 °C

Basic Thermal Model

There is another approach to analyze module thermal performance, to model the overall thermal resistance of the module. This presentation method is especially useful when considering heat sinks. The following equation can be used to calculate the total thermal resistance .

$$RCA = \Delta T_{C, \text{max}} / P_D$$

Where RCA is the module thermal resistance;

$\Delta T_{C, \text{max}}$ is the maximum case temperature rise;

Pd is the module power dissipation.

In this model, Pd, $\Delta T_{C, \text{max}}$, and RCA are equals to current flow, voltage drop, and electrical resistance, respectively, in Ohm's law, as shown in Figure 38. Also, $\Delta T_{C, \text{max}}$ is defined as the difference between the module case temperature (Tc) and the inlet ambient temperature (TA).

$$\Delta T_{C, \text{max}} = T_C - T_A$$

Where Tc is the module case temperature,

TA is the inlet ambient temperature.



Fig.38 Basic Thermal Resistance Model

For AEH 24Vin Series 50W to 150W converters, the module's thermal resistance values versus air velocity have been determined experimentally and shown in figure 39. The highest values on each curve represents the point of natural convection.

Figure 39 is used for determining thermal performance under various conditions of airflow and heat sink configurations.

AEH 24V Input Half-Brick Series Power Converters
2.5V, 3.3V, 5V Single Output, 50-150W

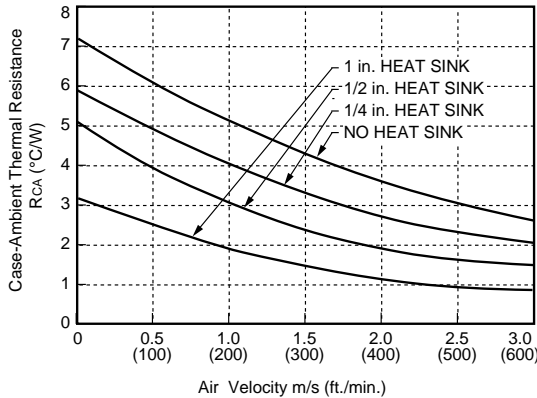

Fig.39 Case-to-Ambient Thermal Resistance Curves; Either Orientation

Example 4. How to determine the allowable minimum airflow to heat sink combinations necessary for a module under a desired Tc and a certain condition?

Although the maximum case temperature for the AEH Series converters is 100°C, you can improve module reliability by limiting Tc,max to a lower value. How to decide? For example, what is the allowable minimum airflow for AEH 100W heat sink combinations at desired Tc of 80 °C?

The working condition is as following:

$$V_{in} = 24 \text{ V}, I_o = 20 \text{ A}, T_A = 40 \text{ }^\circ\text{C}$$

Determine P_D (Fig.30.)

$$P_D = 15 \text{ W}$$

Then solve RCA:

$$RCA = \Delta T_{C, \text{max}} / P_D$$

$$RCA = (T_C - T_A) / P_D$$

$$RCA = (80 - 40) / 15 = 2.7^\circ\text{C/W}$$

determine air velocity from figure 39:

If no heat sink:

$$v = 3 \text{ m/s (600 ft./min.)}$$

If 1/4 in. heat sink:

$$v = 2 \text{ m/s (400 ft./min.)}$$

If 1/2 in. heat sink:

$$v = 1.4 \text{ m/s (280 ft./min.)}$$

If 1 in. heat sink:

$$v = 0.5 \text{ m/s (100 ft./min.)}$$

Example 5. How to determine case temperature (Tc) for the various heat sink configurations at certain air velocity?

What is the allowable Tc for AEH 24Vin 100W heat sink configurations at desired air velocity of 2.0 m/s, and it is operating at a 24 V line voltage, a 20 A output current, a 40 °C maximum ambient temperature?

Determine P_D (Fig.30) with condition:

$$V_{in} = 24 \text{ V}$$

$$I_o = 20 \text{ A}$$

$$T_A = 40 \text{ }^\circ\text{C}$$

$$v = 2.0 \text{ m/s (400 ft./min.)}$$

Get: P_D = 15 W

Determine Tc: T_C = (RCA x P_D) + T_A

Determine the corresponding thermal resistances (RCA) from Figure 39 :

No heat sink: RCA = 3.8 °C/W

$$T_C = (3.8 \times 15) + 40 = 97 \text{ }^\circ\text{C}$$

1/4 in. heat sink: RCA = 2.8 °C/W

$$T_C = (2.8 \times 15) + 40 = 82 \text{ }^\circ\text{C}$$

1/2 in. heat sink: RCA = 2.0 °C/W

$$T_C = (2.0 \times 15) + 40 = 70 \text{ }^\circ\text{C}$$

1 in. heat sink: RCA = 1.2 °C/W

$$T_C = (1.2 \times 15) + 40 = 58 \text{ }^\circ\text{C}$$

In this configuration, the heat sink would not need and the power module does not exceed the maximum case temperature of 100°C.

Mechanical Considerations

Installation

Although AEH 24Vin series converters can be mounted in any orientation, free air-flowing must be taken. Normally power components are always put at the end of the airflow path or have the separate airflow paths. This can keep other system equipment cooler and increase

**AEH 24V Input Half-Brick Series Power Converters
2.5V, 3.3V, 5V Single Output, 50-150W**

component life spans.

Soldering

AEH 24Vin series converters are compatible with standard wave soldering techniques. When wave soldering, the converter pins should be preheated for 20-30 seconds at 110°C, and wave soldered at 260°C for less than 10 seconds.

When hand soldering, the iron temperature should be maintained at 425°C and applied to the converter pins for less than 5 seconds. Longer exposure can cause internal damage to the converter. Cleaning can be performed with cleaning solvent IPA or with water.

MTBF

The MTBF, calculated in accordance with Bellcore TR-NWT-000332 is 1,880,000 hours. Obtaining this MTBF in practice is entirely possible. If the ambient air temperature is expected to exceed +25°C, then we also advise a heatsink on the AEH, oriented for the best possible cooling in the air stream.

ASTECC can supply replacements for converters from other manufacturers, or offer custom solutions. Please contact the factory for details.

**AEH 24V Input Half-Brick Series Power Converters
2.5V, 3.3V, 5V Single Output, 50-150W**

Recommend Hole Pattern

Base-plate side view

Dimensions are in millimeters and (inches).

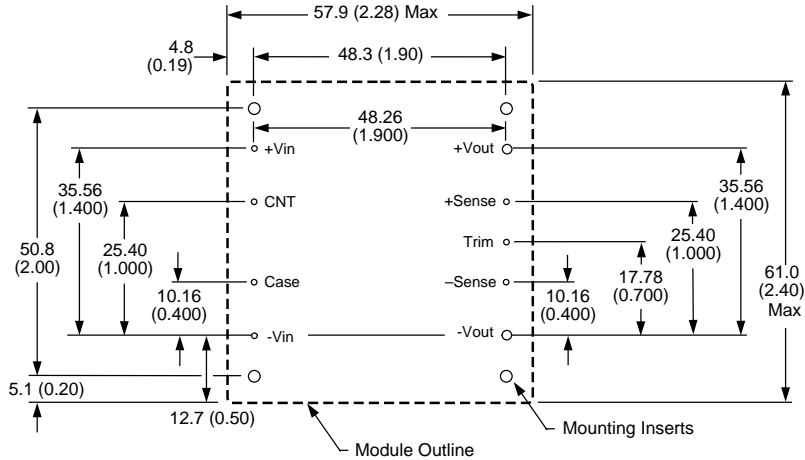

Mechanical chart

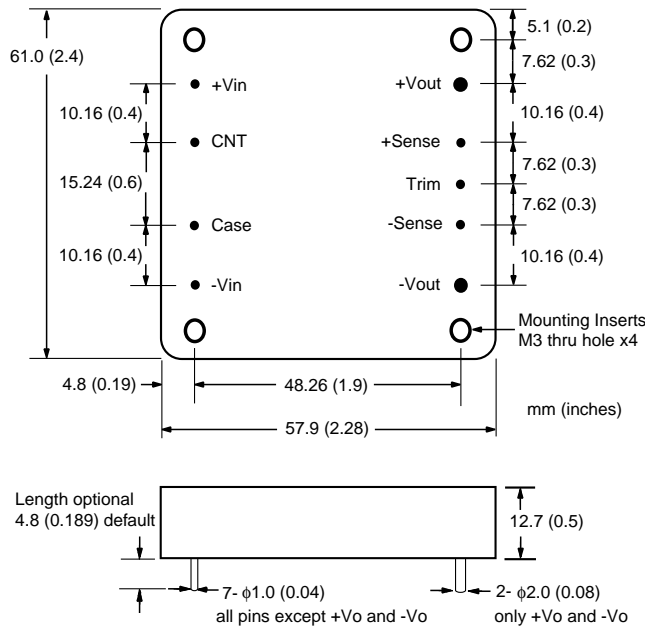

Pin Length Option	Device Code Suffix
4.80mm ± 0.5mm 0.189in. ± 0.020in.	none (default)
3.80mm ± 0.25mm 0.150in. ± 0.010in.	-6
5.80mm ± 0.5mm 0.228in. ± 0.02in.	-7
2.80mm ± 0.25mm 0.110in. ± 0.010in.	-8

Tolerances:
Inches Millimeters
.xx ±0.020 .x ±0.5
.xxx ±0.010 .xx ±0.25

Pins
>4mm ±0.02inch (±0.5mm)
<4mm ±0.01inch (±0.25mm)

Base-plate side view

PART NUMBER DESCRIPTION

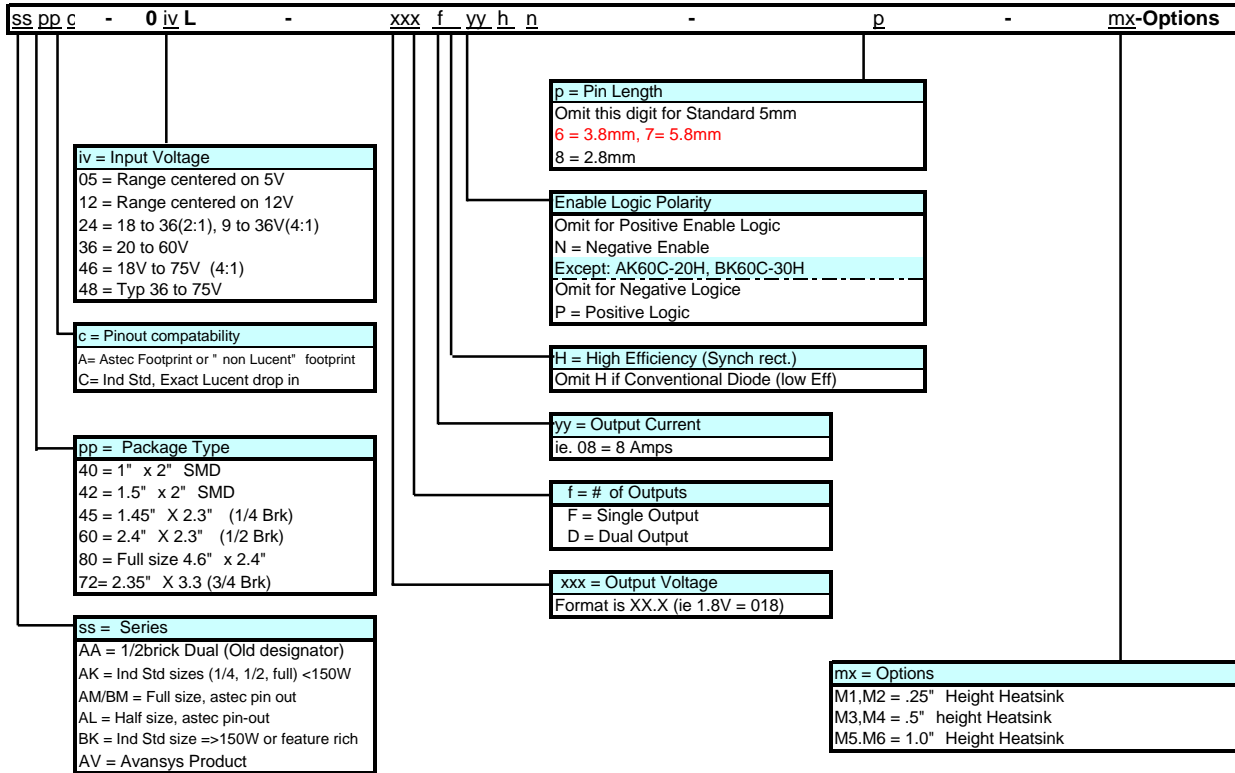

Note: For some products, they may not conform with the PART NUMBER DESCRIPTION above absolutely.

NEW PART NUMBER DESCRIPTION

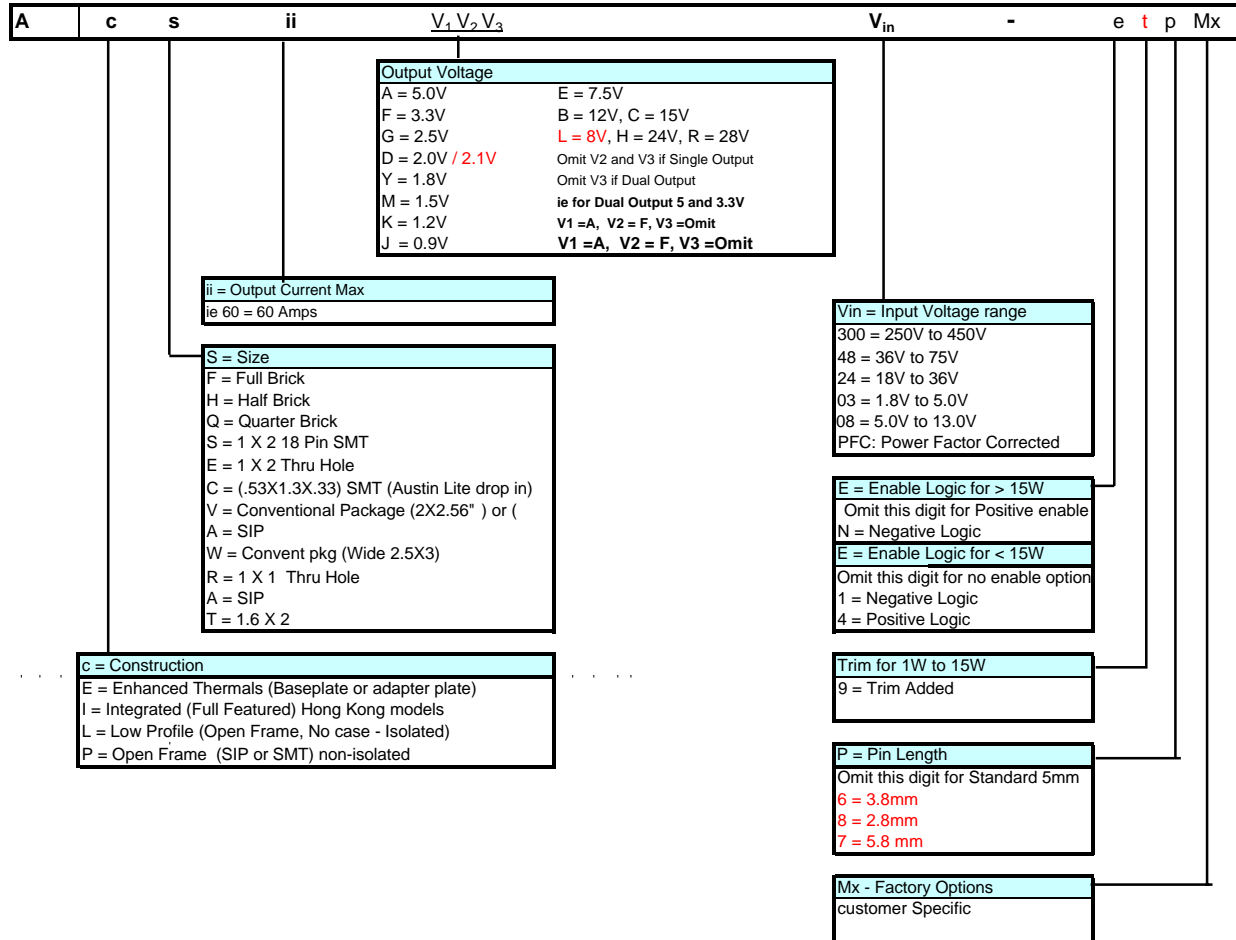

Note: For some products, they may not conform with the NEW PART NUMBER DESCRIPTION above absolutely.