



A Unit of Teledyne Electronics and Communications

CENTIGRID® SURFACE MOUNT COMMERCIAL RELAYS DPDT

SERIES S172

SERIES DESIGNATION	RELAY TYPE
S172	DPDT basic relay
S172D	DPDT relay with internal diode for coil transient suppression

INTERNAL CONSTRUCTION

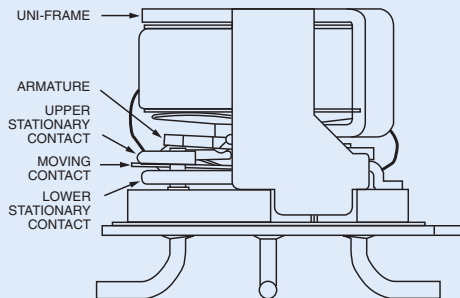

DESCRIPTION

The S172 surface mount Centigrad® relay is an ultraminiature, hermetically sealed, armature relay for commercial applications. Its low profile height (.470) and .100" grid spaced terminals make it an ideal choice where extreme packaging density and/or close PC board spacing are required. The specially formed leads are pre-tinned to make the relays ideal for all types of surface-mount solder reflow processes.

The basic design and internal structure are similar to Teledyne's DPDT 114 Centigrad® relay. Unique construction features and manufacturing techniques provide overall high reliability and excellent resistance to environmental extremes:

- All welded construction.
- Unique uni-frame design providing high magnetic efficiency and mechanical rigidity.
- High force/mass ratios for resistance to shock and vibration.
- Advanced cleaning techniques provide maximum assurance of internal cleanliness.
- Precious metal alloy contact material with gold plating assures excellent high current and dry circuit switching capabilities.

The S172D relay has an internal discrete silicon diode for coil transient suppression.

ENVIRONMENTAL AND PHYSICAL SPECIFICATIONS

Temperature (Ambient)	Storage	-65°C to +125°C
	Operating	-55°C to +85°C
Vibration (General Note 1)		10 g's to 500 Hz
Shock (General Note 1)		30 g's, 6 msec, half-sine
Enclosure		Hermetically sealed
Weight		0.15 oz. (4.3g) max.
Reflow Temperature		260°C max. temp. 1 min. max.

SERIES S172
GENERAL ELECTRICAL SPECIFICATIONS (@25°C) (Notes 2 & 3)

Contact Arrangement	2 Form C (DPDT)	
Rated Duty	Continuous	
Contact Resistance	0.15 ohm max. before life; 0.3 ohm max. after life at 1A/28Vdc (measured 1/8" from header)	
Contact Load Ratings (DC) (See Fig. 1 for other DC resistive voltage/current ratings)	Resistive: 1 Amp/28Vdc Inductive: 200 mA/28Vdc (320 mH) Lamp: 100 mA/28Vdc Low Level: 10 to 50 µA/10 to 50mV	
Contact Life Ratings	5,000,000 cycles (typical) at low level 500,000 cycles (typical) at 0.5A/28Vdc resistive 100,000 cycles min. at all other loads specified above	
Contact Overload Rating	2A/28Vdc Resistive (100 cycles min.)	
Contact Carry Rating	Contact factory	
Operate Time	6.0 msec max. at nominal rated coil voltage	
Release Time	S172: 3.0 msec max. S172D: 6.0 msec max.	
Contact Bounce	1.5 msec max.	
Intercontact Capacitance	0.4 pf typical	
Insulation Resistance	1,000 megohms min. between mutually isolated terminals	
Dielectric Strength	Atmospheric pressure: 300 Vrms/60Hz	
Negative Coil Transient (Vdc)	S172D	2.0 max
Diode P.I.V. (Vdc)	S172D	60 min.

DETAILED ELECTRICAL SPECIFICATIONS (@25°C) (Note 3)

	BASE PART NUMBERS	S172-5	S172-12	S172-26
		S172D-5	S172D-12	S172D-26
Coil Voltage (Vdc)	Nom.	5.0	12.0	26.5
	Max.	5.8	16.0	32.0
Coil Resistance (Ohms ±20%)		64	400	1600
Pick-up Voltage (Vdc, Max.) Pulse Operation		3.8	9.0	18.0
Coil Operating Power at Nominal Voltage (Milliwatts)		405	360	440

TYPICAL DC CONTACT RATINGS (RESISTIVE)

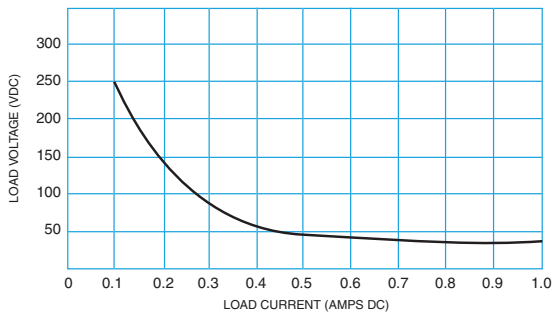
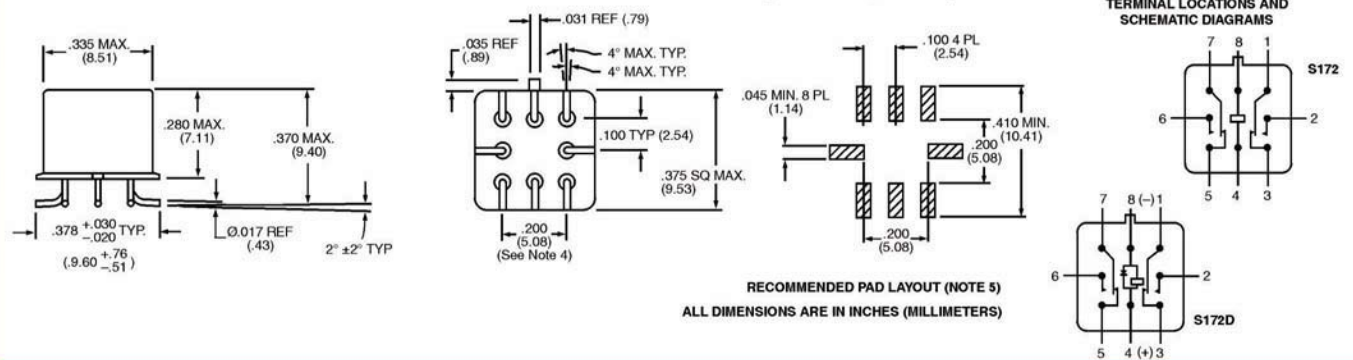

FIGURE 1

GENERAL NOTES

- Relay contacts will exhibit no chatter in excess of 10 µsec or transfer in excess of 1 µsec.
- "Typical" characteristics are based on available data and are best estimates. No on-going verification tests are performed.
- Unless otherwise specified, parameters are initial values.
- Position of leads as they emerge from relay base.
- Leads will fit noted pad layout with no overhang.
- Lead ends are coplanar within .008" wide tolerance zone.
- Terminals coated with SN60 or SN63 solder per QQ-S-571. Base material exposed at sheared end of leads.
- Add "/R" to end of part number for RoHS compliant solder coated pins (Sn99.3/Cu0.7).

OUTLINE DIMENSIONS AND RECOMMENDED PAD LAYOUT (Notes 5, 6 & 7)

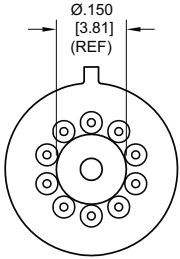
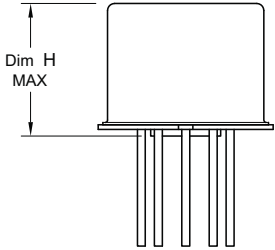
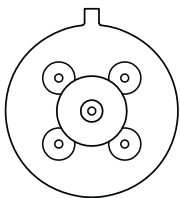
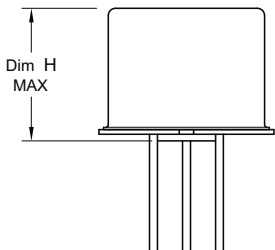
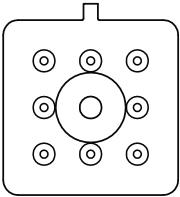
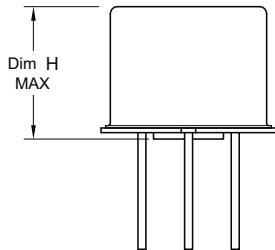
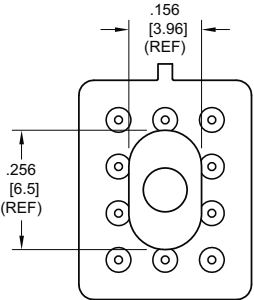
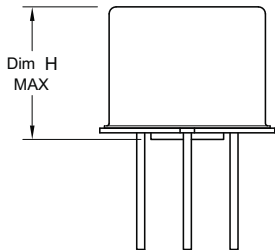

Appendix A: Spacer Pads

Pad designation and bottom view dimensions	Height	For use with the following:	Dim. H Max.
 <p style="text-align: center;">“M4” Pad for TO-5</p>		ER411T ER412, ER412D, ER412DD	.295 (7.49)
		712, 712D, 712TN, RF300, RF310, RF320	.300 (7.62)
		ER420, ER422D, ER420DD, 421, ER421D, ER421DD, ER422, ER422D, ER422DD, 722, 722D, RF341	.305 (7.75)
		ER431T, ER432T, ER432, ER432D, ER432DD	.400 (10.16)
		732, 732D, 732TN, RF303, RF313, RF323	.410 (10.41)
		RF312	.350 (8.89)
 <p style="text-align: center;">“M4” Pad for TO-5</p>		ER411, ER411D, ER411DD	.295 (7.49)
		ER431, ER431D, ER431DD	.400 (10.16)
		RF311	.300 (7.62)
		RF331	.410 (10.41)
 <p style="text-align: center;">“M4” Pad for Centigrid®</p>		172, 172D	.305 (7.75)
		ER114, ER114D, ER114DD, J114, J114D, J114DD	.300 (7.62)
		ER134, ER134D, ER134DD, J134, J134D, J134DD	.400 (10.16)
		RF100	.315 (8.00)
		RF103	.420 (10.67)
 <p style="text-align: center;">“M9” Pad for Centigrid®</p>		122C, A152	.320 (8.13)
		ER116C, J116C	.300 (7.62)
		ER136C, J136C	.400 (10.16)
		RF180	.325 (8.25)
		A150	.305 (7.75)

Notes:

1. Spacer pad material: Polyester film.
2. To specify an “M4” or “M9” spacer pad, refer to the mounting variants portion of the part numbering example in the applicable datasheet.
3. Dimensions are in inches (mm).
4. Unless otherwise specified, tolerance is $\pm .010$ (.25).
5. Add 10 mΩ to the contact resistance show in the datasheet.
6. Add 0.01 oz. (0.25 g) to the weight of the relay assembly shown in the datasheet.

Appendix A: Spreader Pads

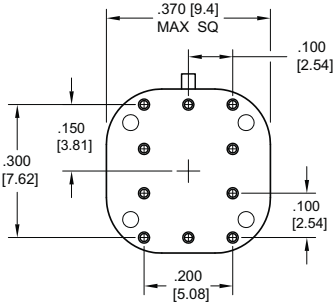
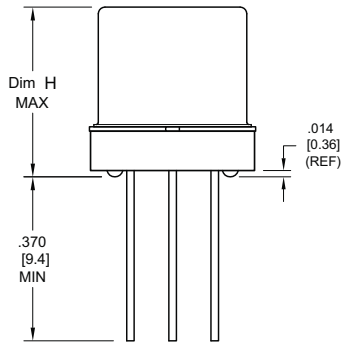
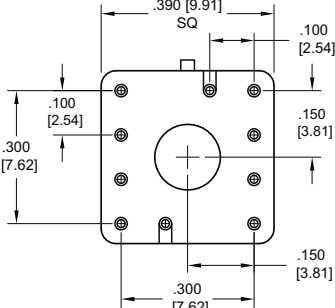
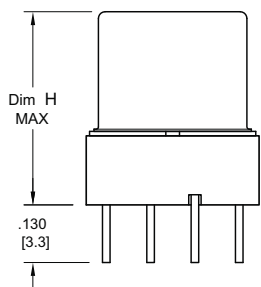
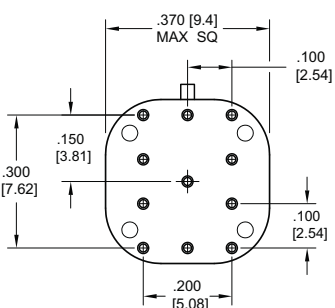
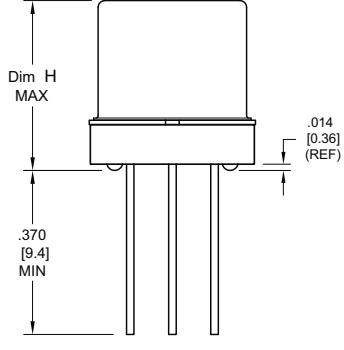
Pad designation and bottom view dimensions	Height	For use with the following:	Dim. H Max.
 <p>“M” Pad <u>5/</u> <u>6/</u> <u>9/</u></p>		ER411T, J411T, ER412, ER412D ER412DD, J412, J412D, J412DD ER412T, J412T	.388 (9.86)
		712, 712D, 712TN	.393 (9.99)
		ER431T, J431T, ER432, ER432D ER432DD, J432, J432D, J432DD ER432T, J432T	.493 (12.52)
		732, 732D, 732TN	.503 (12.78)
		ER420, J420, ER420D, J420D ER420DD, J420DD, ER421, J421 ER421D, J421D, ER421DD J422D, ER422DD, J422DD, 722	.398 (10.11)
 <p>“M2” Pad <u>7/</u> <u>8/</u></p>		ER411T ER412, ER412D, ER412DD J412, J412D, J412DD	.441 (11.20)
		712, 712D	.451 (11.46)
		ER421, ER421D, ER421DD 722, 732D	.451 (11.46)
		ER431T ER432, ER432D, ER432DD	.546 (13.87)
		732, 732D	.556 (14.12)
 <p>“M3” Pad <u>5/</u> <u>6/</u> <u>9/</u></p>		ER411, ER411D, ER411DD ER411TX ER412X, ER412DX, ER412DDX ER412TX	.388 (9.86)
		712X, 712DX, 712TNX	.393 (9.99)
		ER420X, ER420DX, ER420DDX ER421X, ER421DX, ER421DDX ER422X, ER422DX ER422DDX, 722X, 722DDX	.398 (10.11)
		ER431, ER431D, ER431DD ER431TX ER432X, ER432DX, ER432DDX ER432TX	.493 (12.52)
		732X, 732DX, 732TNX	.503 (12.78)

Notes:

1. Spreader pad material: Diallyl Phthalate.
2. To specify an “M”, “M2” or “M3” spreader pad, refer to the mounting variants portion of the part number example in the applicable datasheet.
3. Dimensions are in inches (mm).
4. Unless otherwise specified, tolerance is $\pm .010$ ” (0.25).
- 5/. Add 25 mΩ to the contact resistance shown in the datasheet.
- 6/. Add .01 oz. (0.25 g) to the weight of the relay assembly shown in the datasheet.
- 7/. Add 50 mΩ to the contact resistance shown in the datasheet.
- 8/. Add 0.025 oz (0.71 g) to the weight of the relay assembly shown in the datasheet.
- 9/. M3 pad to be used only when the relay has a center pin (e.g. ER411M3-12A, 722XM3-26.)

Appendix A: Ground Pin Positions

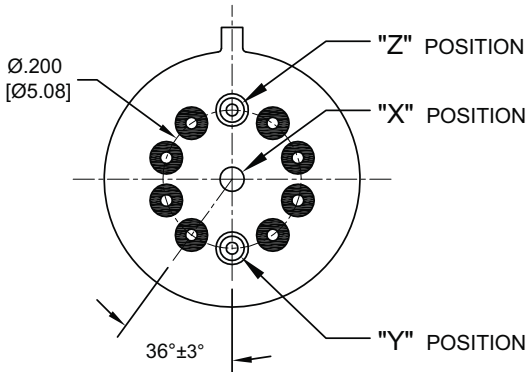

TO-5 Relays:

ER411T, ER412, ER412T, ER420, ER421, ER422,
ER431T, ER432, ER432T, 712, 712TN, 400H, 400K,
400V, RF300, RF303, RF341, RF312, RF310, RF313,
RF320, RF323

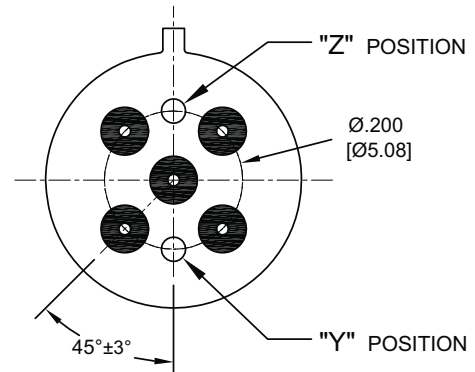

TO-5 Relays:

ER411, ER431, RF311, RF331

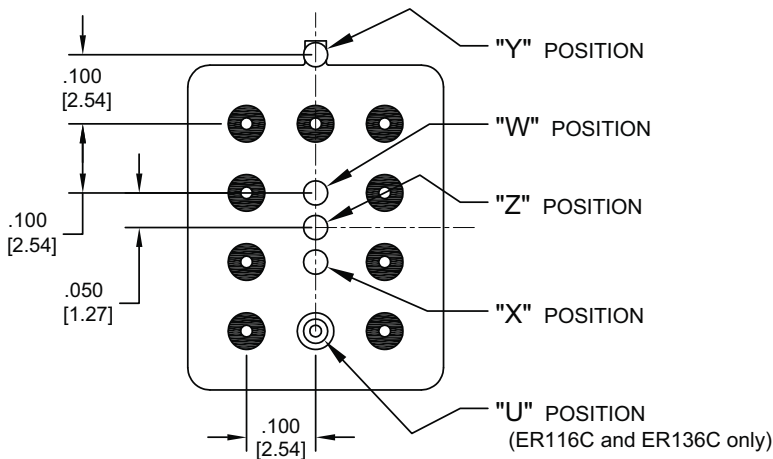

Centigrid® Relays:

RF180, ER116C, 122C, ER136C

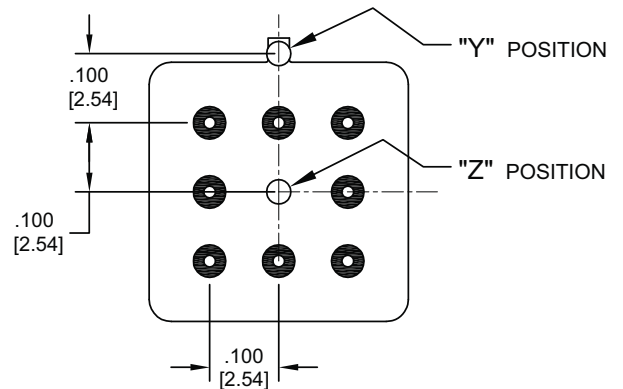

Centigrid® Relays:

RF100, RF103, ER114, ER134, 172

- Indicates ground pin position
- Indicates glass insulated lead position
- ◎ Indicates ground pin or lead position depending on relay type

NOTES

1. Terminal views shown
2. Dimensions are in inches (mm)
3. Tolerances: $\pm .010$ ($\pm .25$) unless otherwise specified
4. Ground pin positions are within $.015$ (0.38) dia. of true position
5. Ground pin head dia., 0.035 (0.89) ref; height 0.010 (0.25) ref.
6. Lead dia. 0.017 (0.43) nom.