

Document Title

512Kx36 & 1Mx18-Bit Flow Through NtRAM™

Revision History

<u>Rev. No.</u>	<u>History</u>	<u>Draft Date</u>	<u>Remark</u>
0.0	1. Initial document.	March. 25. 1999	Preliminary
0.1	1. Update ICC & ISB values.	May. 27. 1999	Preliminary
0.2	1. Change tOE from 3.5ns to 4.0ns at -8 . 2. Change tOE from 3.5ns to 4.0ns at -9 . 3. Change tOE from 3.5ns to 4.0ns at -10 .	June. 22. 1999	Preliminary
0.3	1. Change ISB value from 60mA to 80mA at -8. 2. Change ISB value from 50mA to 70mA at -9 . 3. Change ISB value from 40mA to 60mA at -10 .	Sep. 04. 1999	Preliminary
0.4	1. Changed tCYC from 12ns to 10ns at -9 . 2. Changed DC condition at Icc and parameters Icc ; from 300mA to 320mA at -8, from 260mA to 300mA at -9, from 240mA to 280mA at -10 3. Change pin allocation at 119BGA . - A4 ; from NC to A . - B2 ; from A to CS2 - B4 ; from $\overline{\text{CKE}}$ to ADV - B6 ; from A to CS2 - G4 ; from ADV to A - H4 ; from NC to $\overline{\text{WE}}$ - M4 ; from $\overline{\text{WE}}$ to $\overline{\text{CKE}}$	Nov. 19. 1999	Preliminary
1.0	1. Final Spec Release.	Dec. 08. 1999	Final
2.0	Add access time 7.5ns bin.	Nov. 23. 2000	Final
3.0	1. Remove -10 bin (tCD=10ns)	Feb. 23. 2001	Final

The attached data sheets are prepared and approved by SAMSUNG Electronics. SAMSUNG Electronics CO., LTD. reserve the right to change the specifications. SAMSUNG Electronics will evaluate and reply to your requests and questions on the parameters of this device. If you have any questions, please contact the SAMSUNG branch office near your office, call or contact Headquarters.



K7M163625M K7M161825M

512Kx36 & 1Mx18 Flow-Through NtRAM™

512Kx36 & 1Mx18-Bit Flow Through NtRAM™

FEATURES

- 3.3V+0.165V/-0.165V Power Supply.
- I/O Supply Voltage 3.3V+0.165V/-0.165V for 3.3V I/O or 2.5V+0.4V/-0.125V for 2.5V I/O
- Byte Writable Function.
- Enable clock and suspend operation.
- Single READ/WRITE control pin.
- Self-Timed Write Cycle.
- Three Chip Enable for simple depth expansion with no data contention .
- A interleaved burst or a linear burst mode.
- Asynchronous output enable control.
- Power Down mode.
- TTL-Level Three-State Outputs.
- 100-TQFP-1420A /119BGA(7x17 Ball Grid Array Package).

GENERAL DESCRIPTION

The K7M163625M and K7M161825M are 18,874,368-bits Synchronous Static SRAMs.

The NRAM™, or No Turnaround Random Access Memory utilizes all bandwidth in any combination of operating cycles.

Address, data inputs, and all control signals except output enable and linear burst order are synchronized to input clock.

Burst order control must be tied "High or Low".

Asynchronous inputs include the sleep mode enable(ZZ).

Output Enable controls the outputs at any given time.

Write cycles are internally self-timed and initiated by the rising edge of the clock input. This feature eliminates complex off-chip write pulse generation

and provides increased timing flexibility for incoming signals.

For read cycles, Flow-Through SRAM allows output data to simply flow freely from the memory array.

The K7M163625M and K7M161825M are implemented with SAMSUNG's high performance CMOS technology and is available in 100pin TQFP and 119BGA packages. Multiple power and ground pins minimize ground bounce.

FAST ACCESS TIMES

Parameter	Symbol	-75	-85	-90	Unit
Cycle Time	t _{CYC}	8.5	10	10	ns
Clock Access Time	t _{CD}	7.5	8.5	9.0	ns
Output Enable Access Time	t _{OE}	4.0	4.0	4.0	ns

LOGIC BLOCK DIAGRAM

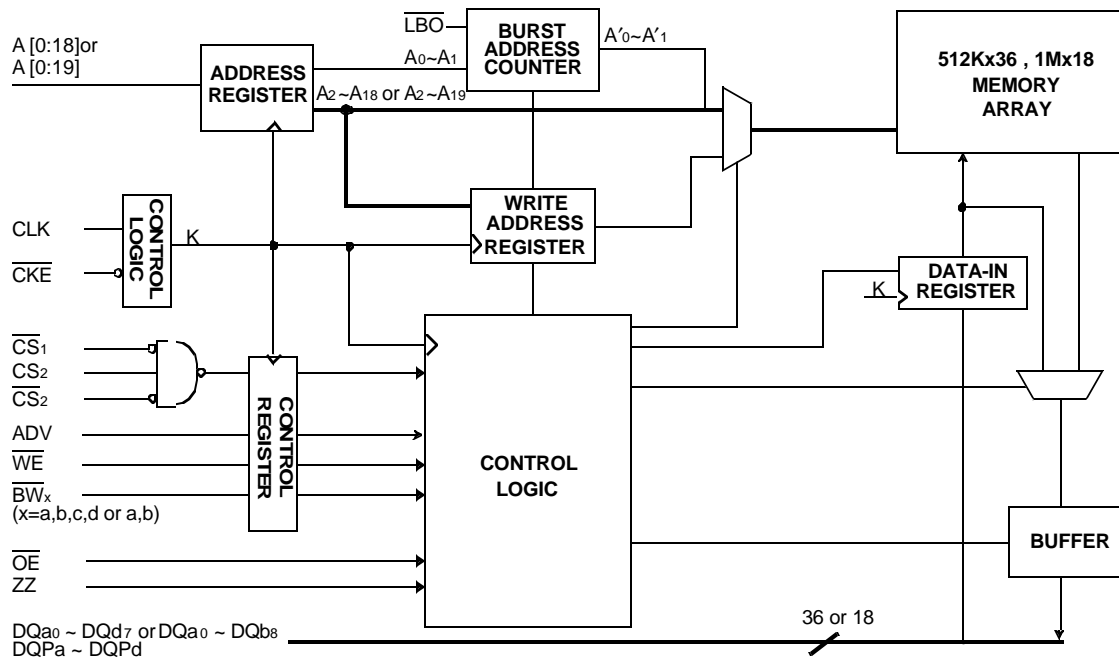

NtRAM™ and No Turnaround Random Access Memory are trademarks of Samsung.



ELECTRONICS

**K7M163625M
K7M161825M**

512Kx36 & 1Mx18 Flow-Through NtRAM™

PIN CONFIGURATION(TOP VIEW)

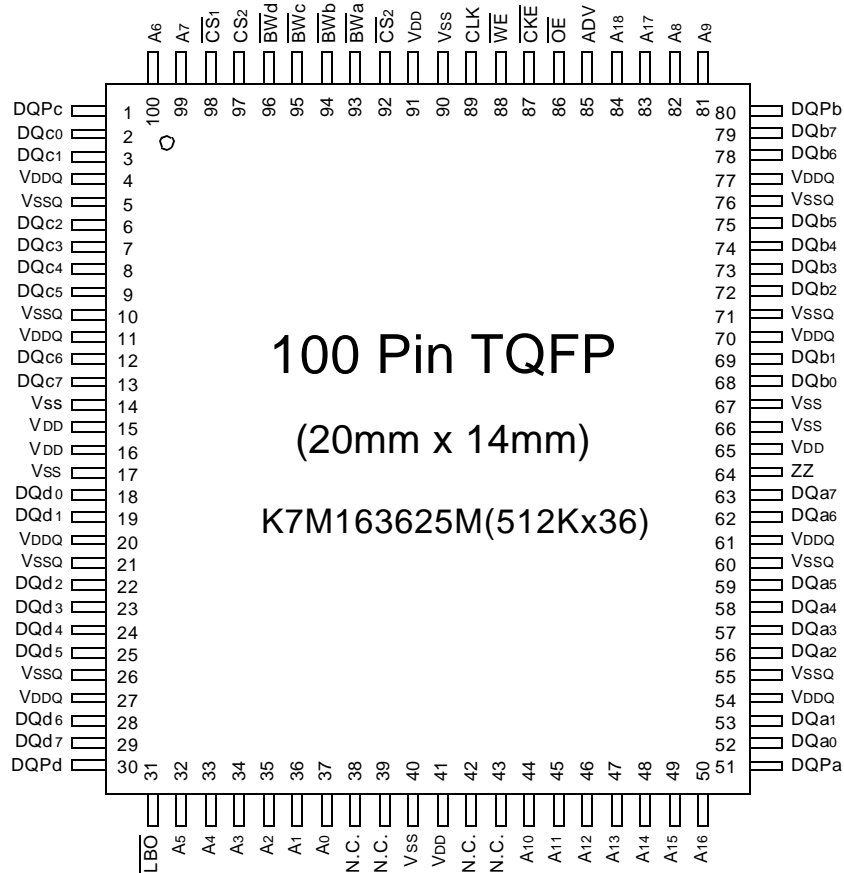

PIN NAME

SYMBOL	PIN NAME	TQFP PIN NO.	SYMBOL	PIN NAME	TQFP PIN NO.
A0 - A18	Address Inputs	32,33,34,35,36,37,44 45,46,47,48,49,50,81 82,83,84,99,100	VDD	Power Supply(+3.3V)	15,16,41,65,91
			VSS	Ground	14,17,40,66,67,90
ADV	Address Advance/Load	85	N.C.	No Connect	38,39,42,43
WE	Read/Write Control Input	88			
CLK	Clock	89	DQa0~a7	Data Inputs/Outputs	52,53,56,57,58,59,62,63
CKE	Clock Enable	87	DQb0~b7	Data Inputs/Outputs	68,69,72,73,74,75,78,79
CS1	Chip Select	98	DQc0~c7	Data Inputs/Outputs	2,3,6,7,8,9,12,13
CS2	Chip Select	97	DQd0~d7	Data Inputs/Outputs	18,19,22,23,24,25,28,29
CS2	Chip Select	92	DQPa~Pd	Data Inputs/Outputs	51,80,1,30
BWx(x=a,b,c,d)	Byte Write Inputs	93,94,95,96	VDDQ	Output Power Supply (2.5V or 3.3V)	4,11,20,27,54,61,70,77
OE	Output Enable	86	VSSQ	Output Ground	5,10,21,26,55,60,71,76
ZZ	Power Sleep Mode	64			
LBO	Burst Mode Control	31			

Notes : 1. A₀ and A₁ are the two least significant bits(LSB) of the address field and set the internal burst counter if burst is desired.



**K7M163625M
K7M161825M**

512Kx36 & 1Mx18 Flow-Through NtRAM™

PIN CONFIGURATION(TOP VIEW)

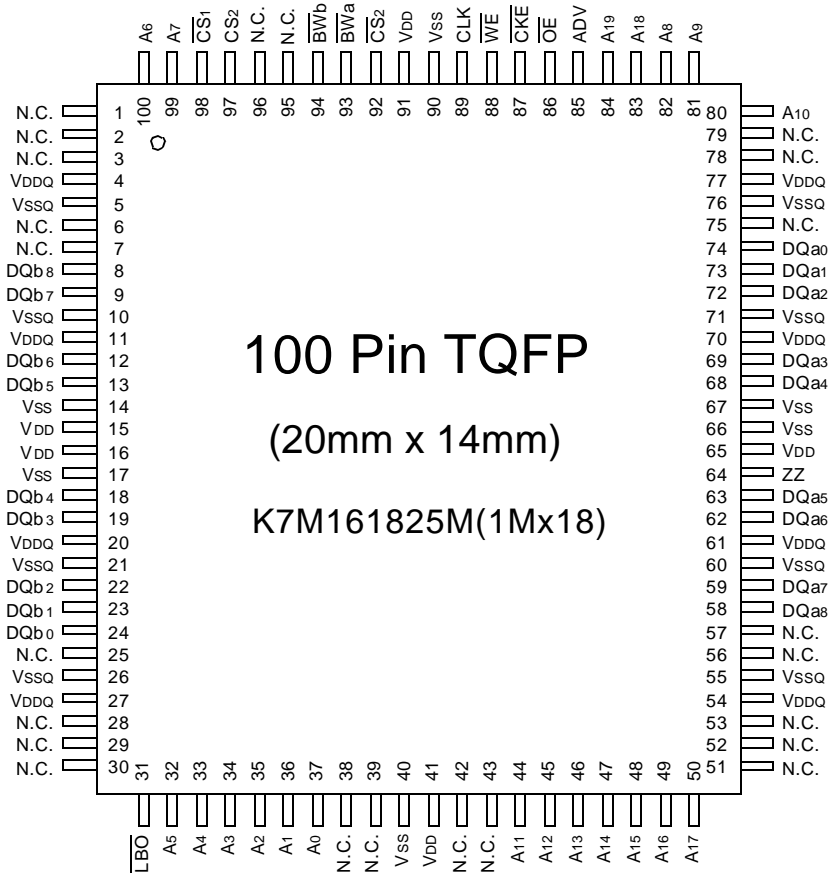

PIN NAME

SYMBOL	PIN NAME	TQFP PIN NO.	SYMBOL	PIN NAME	TQFP PIN NO.
A0 - A19	Address Inputs	32,33,34,35,36,37,44 45,46,47,48,49,50,80 81,82,83,84,99,100	VDD	Power Supply(+3.3V)	15,16,41,65,91
			VSS	Ground	14,17,40,66,67,90
ADV	Address Advance/Load	85	N.C.	No Connect	1,2,3,6,7,25,28,29,30, 38,39,42,43,51,52,53, 56,57,75,78,79,95,96
WE	Read/Write Control Input	88			
CLK	Clock	89			
CKE	Clock Enable	87			
CS1	Chip Select	98	DQa0~a8	Data Inputs/Outputs	58,59,62,63,68,69,72,73,74
CS2	Chip Select	97	DQb0~b8	Data Inputs/Outputs	8,9,12,13,18,19,22,23,24
CS2	Chip Select	92			
BWx(x=a,b)	Byte Write Inputs	93,94			
OE	Output Enable	86	VDDQ	Output Power Supply (2.5V or 3.3V)	4,11,20,27,54,61,70,77
ZZ	Power Sleep Mode	64			
LBO	Burst Mode Control	31	VSSQ	Output Ground	5,10,21,26,55,60,71,76

Notes : 1. A0 and A1 are the two least significant bits(LSB) of the address field and set the internal burst counter if burst is desired.

**K7M163625M
K7M161825M**

512Kx36 & 1Mx18 Flow-Through NtRAM™

119BGA PACKAGE PIN CONFIGURATIONS(TOP VIEW)

K7M163625M(512Kx36)

	1	2	3	4	5	6	7
A	VDDQ	A	A	A	A	A	VDDQ
B	NC	CS2	A	ADV	A	$\overline{CS2}$	NC
C	NC	A	A	VDD	A	A	NC
D	DQc	DQPc	VSS	NC	VSS	DQPb	DQb
E	DQc	DQc	VSS	$\overline{CS1}$	VSS	DQb	DQb
F	VDDQ	DQc	VSS	\overline{OE}	VSS	DQb	VDDQ
G	DQc	DQc	\overline{BWc}	A	\overline{BWb}	DQb	DQb
H	DQc	DQc	VSS	\overline{WE}	VSS	DQb	DQb
J	VDDQ	VDD	NC	VDD	NC	VDD	VDDQ
K	DQd	DQd	VSS	CLK	VSS	DQa	DQa
L	DQd	DQd	\overline{BWd}	NC	\overline{BWa}	DQa	DQa
M	VDDQ	DQd	VSS	\overline{CKE}	VSS	DQa	VDDQ
N	DQd	DQd	VSS	A1*	VSS	DQa	DQa
P	DQd	DQPd	VSS	A0*	VSS	DQPa	DQa
R	NC	A	\overline{LBO}	VDD	NC	A	NC
T	NC	NC	A	A	A	NC	ZZ
U	VDDQ	NC	NC	NC	NC	NC	VDDQ

Note : * A₀ and A₁ are the two least significant bits(LSB) of the address field and set the internal burst counter if burst is desired.

PIN NAME

SYMBOL	PIN NAME	SYMBOL	PIN NAME
A	Address Inputs	VDD	Power Supply
A ₀ ,A ₁	Burst Address Inputs	VSS	Ground
ADV	Address Advance/Load	N.C.	No Connect
\overline{WE}	Read/Write Control Input		
CLK	Clock	DQa	Data Inputs/Outputs
\overline{CKE}	Clock Enable	DQb	Data Inputs/Outputs
$\overline{CS1}$	Chip Select	DQc	Data Inputs/Outputs
CS ₂	Chip Select	DQd	Data Inputs/Outputs
$\overline{CS2}$	Chip Select	DQPa-Pd	Data Inputs/Outputs
\overline{BWx} (x=a,b,c,d)	Byte Write Inputs	VDDQ	Output Power Supply
\overline{OE}	Output Enable		
ZZ	Power Sleep Mode		
\overline{LBO}	Burst Mode Control		



**K7M163625M
K7M161825M**

512Kx36 & 1Mx18 Flow-Through NtRAM™

119BGA PACKAGE PIN CONFIGURATIONS(TOP VIEW)

K7M161825M(1Mx18)

	1	2	3	4	5	6	7
A	VDDQ	A	A	A	A	A	VDDQ
B	NC	CS2	A	ADV	A	$\overline{CS2}$	NC
C	NC	A	A	VDD	A	A	NC
D	DQb	NC	VSS	NC	VSS	DQP _a	NC
E	NC	DQb	VSS	$\overline{CS1}$	VSS	NC	DQ _a
F	VDDQ	NC	VSS	\overline{OE}	VSS	DQ _a	VDDQ
G	NC	DQb	\overline{BWb}	A	VSS	NC	DQ _a
H	DQb	NC	VSS	\overline{WE}	VSS	DQ _a	NC
J	VDDQ	VDD	NC	VDD	NC	VDD	VDDQ
K	NC	DQb	VSS	CLK	VSS	NC	DQ _a
L	DQb	NC	VSS	NC	\overline{BWa}	DQ _a	NC
M	VDDQ	DQb	VSS	\overline{CKE}	VSS	NC	VDDQ
N	DQb	NC	VSS	A ₁ *	VSS	DQ _a	NC
P	NC	DQP _b	VSS	A ₀ *	VSS	NC	DQ _a
R	NC	A	\overline{LBO}	VDD	NC	A	NC
T	NC	A	A	NC	A	A	ZZ
U	VDDQ	NC	NC	NC	NC	NC	VDDQ

Note : * A₀ and A₁ are the two least significant bits(LSB) of the address field and set the internal burst counter if burst is desired.

PIN NAME

SYMBOL	PIN NAME	SYMBOL	PIN NAME
A	Address Inputs	VDD	Power Supply
A ₀ ,A ₁	Burst Address Inputs	VSS	Ground
ADV	Address Advance/Load	N.C.	No Connect
\overline{WE}	Read/Write Control Input		
CLK	Clock		
\overline{CKE}	Clock Enable	DQ _a	Data Inputs/Outputs
$\overline{CS1}$	Chip Select	DQ _b	Data Inputs/Outputs
CS ₂	Chip Select	DQP _a , P _b	Data Inputs/Outputs
$\overline{CS2}$	Chip Select		
\overline{BWx} (x=a,b)	Byte Write Inputs	VDDQ	Output Power Supply
\overline{OE}	Output Enable		
ZZ	Power Sleep Mode		
LBO	Burst Mode Control		

FUNCTION DESCRIPTION

The K7M163625M and K7M161825M are NtRAM™ designed to sustain 100% bus bandwidth by eliminating turnaround cycle when there is transition from Read to Write, or vice versa.

All inputs (with the exception of \overline{OE} , \overline{LBO} and ZZ) are synchronized to rising clock edges.

All read, write and deselect cycles are initiated by the ADV input. Subsequent burst addresses can be internally generated by the burst advance pin (ADV). ADV should be driven to Low once the device has been deselected in order to load a new address for next operation.

Clock Enable(\overline{CKE}) pin allows the operation of the chip to be suspended as long as necessary. When \overline{CKE} is high, all synchronous inputs are ignored and the internal device registers will hold their previous values.

NtRAM™ latches external address and initiates a cycle, when \overline{CKE} , ADV are driven to low and all three chip enables($\overline{CS1}$, $CS2$, $\overline{CS2}$) are active .

Output Enable(\overline{OE}) can be used to disable the output at any given time.

Read operation is initiated when at the rising edge of the clock, the address presented to the address inputs are latched in the address register, \overline{CKE} is driven low, all three chip enables($CS1$, $CS2$, $\overline{CS2}$) are active, the write enable input signals WE are driven high, and ADV driven low. Data appears at the outputs within the same clock cycle as the address for the data. Also during read operation \overline{OE} must be driven low for the device to drive out the requested data.

Write operation occurs when \overline{WE} is driven low at the rising edge of the clock. $\overline{BW}[d:a]$ can be used for byte write operation. The Flow Through NtRAM™ uses a late write cycle to utilize 100% of the bandwidth.

At the first rising edge of the clock, \overline{WE} and address are registered, and the data associated with that address is required one cycle later.

Subsequent addresses are generated by ADV High for the burst access as shown below. The starting point of the burst sequence is provided by the external address. The burst address counter wraps around to its initial state upon completion.

The burst sequence is determined by the state of the \overline{LBO} pin. When this pin is low, linear burst sequence is selected.

And when this pin is high, Interleaved burst sequence is selected.

During normal operation, ZZ must be driven low. When ZZ is driven high, the SRAM will enter a Power Sleep Mode after 2 cycles. At this time, internal state of the SRAM is preserved. When ZZ returns to low, the SRAM normally operates after 2 cycles of wake up time.

BURST SEQUENCE TABLE

(Interleaved Burst, \overline{LBO} =High)

\overline{LBO} PIN	HIGH	Case 1		Case 2		Case 3		Case 4	
		A1	A0	A1	A0	A1	A0	A1	A0
	First Address	0	0	0	1	1	0	1	1
	↓	0	1	0	0	1	1	1	0
	↓	1	0	1	1	0	0	0	1
	Fourth Address	1	1	1	0	0	1	0	0

(Linear Burst, \overline{LBO} =Low)

\overline{LBO} PIN	LOW	Case 1		Case 2		Case 3		Case 4	
		A1	A0	A1	A0	A1	A0	A1	A0
	First Address	0	0	0	1	1	0	1	1
	↓	0	1	1	0	1	1	0	0
	↓	1	0	1	1	0	0	0	1
	Fourth Address	1	1	0	0	0	1	1	0

Note : 1. \overline{LBO} pin must be tied to High or Low, and Floating State must not be allowed.

STATE DIAGRAM FOR NtRAM™

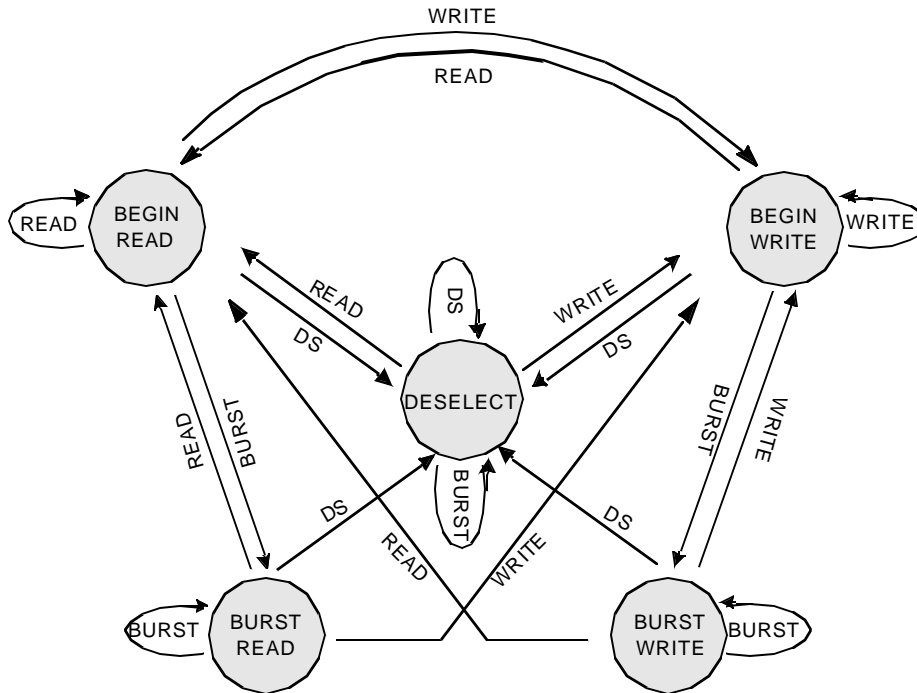

COMMAND	ACTION
DS	DESELECT
READ	BEGIN READ
WRITE	BEGIN WRITE
BURST	BEGIN READ BEGIN WRITE CONTINUE DESELECT

Notes : 1. An IGNORE CLOCK EDGE cycle is not shown in the above diagram. This is because CKE HIGH only blocks the clock(CLK) input and does not change the state of the device.
2. States change on the rising edge of the clock(CLK)

TRUTH TABLES

SYNCHRONOUS TRUTH TABLE

CS ₁	CS ₂	CS ₂	ADV	WE	BW _x	OE	CKE	CLK	ADDRESS ACCESSED	OPERATION
H	X	X	L	X	X	X	L	↑	N/A	Not Selected
X	L	X	L	X	X	X	L	↑	N/A	Not Selected
X	X	H	L	X	X	X	L	↑	N/A	Not Selected
X	X	X	H	X	X	X	L	↑	N/A	Not Selected Continue
L	H	L	L	H	X	L	L	↑	External Address	Begin Burst Read Cycle
X	X	X	H	X	X	L	L	↑	Next Address	Continue Burst Read Cycle
L	H	L	L	H	X	H	L	↑	External Address	NOP/Dummy Read
X	X	X	H	X	X	H	L	↑	Next Address	Dummy Read
L	H	L	L	L	L	X	L	↑	External Address	Begin Burst Write Cycle
X	X	X	H	X	L	X	L	↑	Next Address	Continue Burst Write Cycle
L	H	L	L	L	H	X	L	↑	N/A	NOP/Write Abort
X	X	X	H	X	H	X	L	↑	Next Address	Write Abort
X	X	X	X	X	X	X	H	↑	Current Address	Ignore Clock

- Notes :** 1. X means "Don't Care". 2. The rising edge of clock is symbolized by (↑).
 3. A continue deselect cycle can only be entered if a deselect cycle is executed first.
 4. WRITE = L means Write operation in WRITE TRUTH TABLE.
 WRITE = H means Read operation in WRITE TRUTH TABLE.
 5. Operation finally depends on status of asynchronous input pins(ZZ and OE).

WRITE TRUTH TABLE (x36)

WE	BW _a	BW _b	BW _c	BW _d	OPERATION
H	X	X	X	X	READ
L	L	H	H	H	WRITE BYTE a
L	H	L	H	H	WRITE BYTE b
L	H	H	L	H	WRITE BYTE c
L	H	H	H	L	WRITE BYTE d
L	L	L	L	L	WRITE ALL BYTES
L	H	H	H	H	WRITE ABORT/NOP

- Notes :** 1. X means "Don't Care".
 2. All inputs in this table must meet setup and hold time around the rising edge of CLK(↑).

WRITE TRUTH TABLE (x18)

WE	BW _a	BW _b	OPERATION
H	X	X	READ
L	L	H	WRITE BYTE a
L	H	L	WRITE BYTE b
L	L	L	WRITE ALL BYTES
L	H	H	WRITE ABORT/NOP

- Notes :** 1. X means "Don't Care".
 2. All inputs in this table must meet setup and hold time around the rising edge of CLK(↑).



ASYNCHRONOUS TRUTH TABLE

Operation	ZZ	\overline{OE}	I/O STATUS
Sleep Mode	H	X	High-Z
Read	L	L	DQ
	L	H	High-Z
Write	L	X	Din, High-Z
Deselected	L	X	High-Z

Notes

1. X means "Don't Care".
2. Sleep Mode means power Sleep Mode of which stand-by current does not depend on cycle time.
3. Deselected means power Sleep Mode of which stand-by current depends on cycle time.

ABSOLUTE MAXIMUM RATINGS*

PARAMETER	SYMBOL	RATING	UNIT
Voltage on V _{DD} Supply Relative to V _{SS}	V _{DD}	-0.3 to 4.6	V
Voltage on Any Other Pin Relative to V _{SS}	V _{IN}	-0.3 to 4.6	V
Power Dissipation	P _D	1.6	W
Storage Temperature	T _{STG}	-65 to 150	°C
Operating Temperature	T _{OPR}	0 to 70	°C
Storage Temperature Range Under Bias	T _{BIAS}	-10 to 85	°C

*Notes : Stresses greater than those listed under "Absolute Maximum Ratings" may cause permanent damage to the device. This is a stress rating only and functional operation of the device at these or any other conditions above those indicated in the operating sections of this specification is not implied. Exposure to absolute maximum rating conditions for extended periods may affect reliability.

OPERATING CONDITIONS at 3.3V I/O(0°C ≤ T_A ≤ 70°C)

PARAMETER	SYMBOL	MIN	Typ.	MAX	UNIT
Supply Voltage	V _{DD}	3.135	3.3	3.465	V
	V _{DDQ}	3.135	3.3	3.465	V
Ground	V _{SS}	0	0	0	V

OPERATING CONDITIONS at 2.5V I/O(0°C ≤ T_A ≤ 70°C)

PARAMETER	SYMBOL	MIN	Typ.	MAX	UNIT
Supply Voltage	V _{DD}	3.135	3.3	3.465	V
	V _{DDQ}	2.375	2.5	2.9	V
Ground	V _{SS}	0	0	0	V

CAPACITANCE*(T_A=25°C, f=1MHz)

PARAMETER	SYMBOL	TEST CONDITION	MIN	MAX	UNIT
Input Capacitance	C _{IN}	V _{IN} =0V	-	7	pF
Output Capacitance	C _{OUT}	V _{OUT} =0V	-	9	pF

*Note : Sampled not 100% tested.

DC ELECTRICAL CHARACTERISTICS($V_{DD}=3.3V+0.165V/-0.165V$, $T_A=0^{\circ}C$ to $+70^{\circ}C$)

PARAMETER	SYMBOL	TEST CONDITIONS	MIN	MAX	UNIT	NOTES	
Input Leakage Current(except ZZ)	I _{IL}	$V_{DD}=\text{Max}$; $V_{IN}=V_{SS}$ to V_{DD}	-2	+2	μA		
Output Leakage Current	I _{OL}	Output Disabled,	-2	+2	μA		
Operating Current	I _{CC}	Device Selected, I _{OUT} =0mA, ZZ≤V _{IL} , Cycle Time ≥ t _{CYC} Min	-75	-	340	mA	1,2
			-85	-	320		
			-90	-	300		
Standby Current	I _{SB}	Device deselected, I _{OUT} =0mA, ZZ≤V _{IL} , f=Max, All Inputs≤0.2V or ≥ V _{DD} -0.2V	-75	-	90	mA	
			-85	-	80		
			-90	-	70		
	I _{SB1}	Device deselected, I _{OUT} =0mA, ZZ≤0.2V, f=0, All Inputs=fixed (V _{DD} -0.2V or 0.2V)	-		30	mA	
I _{SB2}	Device deselected, I _{OUT} =0mA, ZZ≥V _{DD} -0.2V, f=Max, All Inputs≤V _{IL} or ≥V _{IH}	-		30	mA		
Output Low Voltage(3.3V I/O)	V _{OL}	I _{OL} =8.0mA	-	0.4	V		
Output High Voltage(3.3V I/O)	V _{OH}	I _{OH} =-4.0mA	2.4	-	V		
Output Low Voltage(2.5V I/O)	V _{OL}	I _{OL} =1.0mA	-	0.4	V		
Output High Voltage(2.5V I/O)	V _{OH}	I _{OH} =-1.0mA	2.0	-	V		
Input Low Voltage(3.3V I/O)	V _{IL}		-0.3*	0.8	V		
Input High Voltage(3.3V I/O)	V _{IH}		2.0	V _{DD} +0.5**	V	3	
Input Low Voltage(2.5V I/O)	V _{IL}		-0.3*	0.7	V		
Input High Voltage(2.5V I/O)	V _{IH}		1.7	V _{DD} +0.5**	V	3	

Notes : 1. Reference AC Operating Conditions and Characteristics for input and timing.
2. Data states are all zero.
3. In Case of I/O Pins, the Max. V_{IH}=V_{DD}+0.3V.

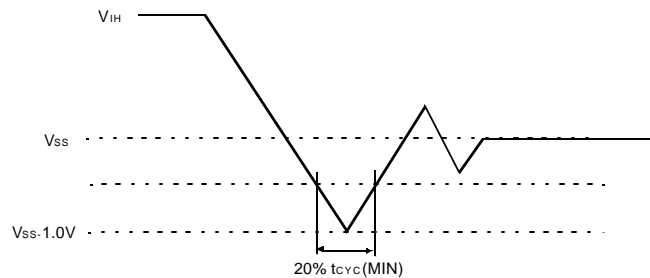

TEST CONDITIONS

($V_{DD}=3.3V+0.165V/-0.165V$, $V_{DDQ}=3.3V+0.165V/-0.165V$ or $V_{DDQ}=3.3V+0.165V/-0.165V$, $V_{DDQ}=2.5V+0.4V/-0.125V$, $T_A=0$ to $70^{\circ}C$)

PARAMETER	VALUE
Input Pulse Level(for 3.3V I/O)	0 to 3.0V
Input Pulse Level(for 2.5V I/O)	0 to 2.5V
Input Rise and Fall Time(Measured at 20% to 80% for 3.3V I/O)	1.0V/ns
Input Rise and Fall Time(Measured at 20% to 80% for 2.5V I/O)	1.0V/ns
Input and Output Timing Reference Levels for 3.3V I/O	1.5V
Input and Output Timing Reference Levels for 2.5V I/O	V _{DDQ} /2
Output Load	See Fig. 1

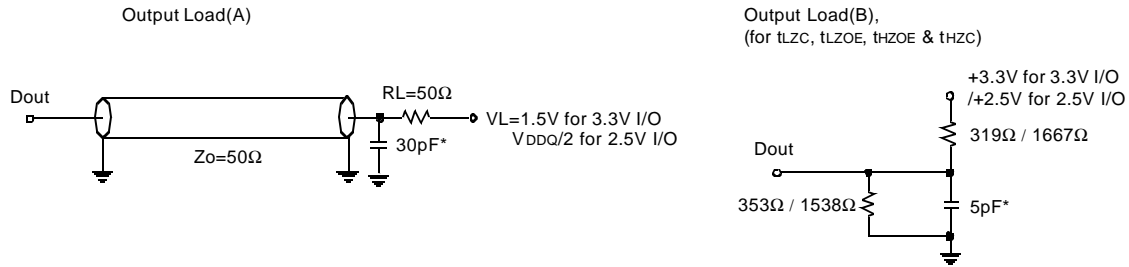

* Including Scope and Jig Capacitance

Fig. 1

AC TIMING CHARACTERISTICS(VDD=3.3V+0.165V/-0.165V, TA=0°C to +70°C)

PARAMETER	SYMBOL	-75		-85		-90		UNIT
		MIN	MAX	MIN	MAX	MIN	MAX	
Cycle Time	tCYC	8.5	-	10	-	10	-	ns
Clock Access Time	tCD	-	7.5	-	8.5	-	9.0	ns
Output Enable to Data Valid	tOE	-	4.0	-	4.0	-	4.0	ns
Clock High to Output Low-Z	tLZC	2.5	-	2.5	-	2.5	-	ns
Output Hold from Clock High	tOH	2.5	-	2.5	-	2.5	-	ns
Output Enable Low to Output Low-Z	tLZOE	0	-	0	-	0	-	ns
Output Enable High to Output High-Z	tHZOE	-	4.0	-	4.0	-	4.0	ns
Clock High to Output High-Z	tHZC	-	5.0	-	5.0	-	5.0	ns
Clock High Pulse Width	tCH	2.5	-	3.0	-	3.0	-	ns
Clock Low Pulse Width	tCL	2.5	-	3.0	-	3.0	-	ns
Address Setup to Clock High	tAS	2.0	-	2.0	-	2.0	-	ns
$\overline{\text{CKE}}$ Setup to Clock High	tCES	2.0	-	2.0	-	2.0	-	ns
Data Setup to Clock High	tDS	2.0	-	2.0	-	2.0	-	ns
Write Setup to Clock High ($\overline{\text{WE}}$, $\overline{\text{BWx}}$)	tWS	2.0	-	2.0	-	2.0	-	ns
Address Advance Setup to Clock High	tADVS	2.0	-	2.0	-	2.0	-	ns
Chip Select Setup to Clock High	tCSS	2.0	-	2.0	-	2.0	-	ns
Address Hold from Clock High	tAH	0.5	-	0.5	-	0.5	-	ns
$\overline{\text{CKE}}$ Hold from Clock High	tCEH	0.5	-	0.5	-	0.5	-	ns
Data Hold from Clock High	tDH	0.5	-	0.5	-	0.5	-	ns
Write Hold from Clock High ($\overline{\text{WE}}$, $\overline{\text{BWx}}$)	tWH	0.5	-	0.5	-	0.5	-	ns
Address Advance Hold from Clock High	tADVH	0.5	-	0.5	-	0.5	-	ns
Chip Select Hold from Clock High	tCSH	0.5	-	0.5	-	0.5	-	ns
ZZ High to Power Down	tPDS	2	-	2	-	2	-	cycle
ZZ Low to Power Up	tPUS	2	-	2	-	2	-	cycle

Notes : 1. All address inputs must meet the specified setup and hold times for all rising clock(CLK) edges when ADV is sampled low and CS is sampled low. All other synchronous inputs must meet the specified setup and hold times whenever this device is chip selected.
 2. Chip selects must be valid at each rising edge of CLK(when ADV is Low) to remain enabled.
 3. A write cycle is defined by WE low having been registered into the device at ADV Low, A Read cycle is defined by WE High with ADV Low, Both cases must meet setup and hold times.
 4. To avoid bus contention, At a given voltage and temperature tLZC is more than tHZC.
 The soecs as shown do not imply bus contention because tLZC is a Min. parameter that is worst case at totally different test conditions (0°C,3.465V) than tHZC, which is a Max. parameter(worst case at 70°C,3.135V)
 It is not possible for two SRAMs on the same board to be at such different voltage and temperatue.

SLEEP MODE

SLEEP MODE is a low current, power-down mode in which the device is deselected and current is reduced to I_{SB2} . The duration of SLEEP MODE is dictated by the length of time the ZZ is in a High state.

After entering SLEEP MODE, all inputs except ZZ become disabled and all outputs go to High-Z

The ZZ pin is an asynchronous, active high input that causes the device to enter SLEEP MODE.

When the ZZ pin becomes a logic High, I_{SB2} is guaranteed after the time t_{ZZI} is met. Any operation pending when entering SLEEP MODE is not guaranteed to successful complete. Therefore, SLEEP MODE (READ or WRITE) must not be initiated until valid pending operations are completed. Similarly, when exiting SLEEP MODE during t_{PUS} , only a DESELECT or READ cycle should be given while the SRAM is transitioning out of SLEEP MODE.

SLEEP MODE ELECTRICAL CHARACTERISTICS

DESCRIPTION	CONDITIONS	SYMBOL	MIN	MAX	UNITS
Current during SLEEP MODE	$ZZ \geq V_{IH}$	I_{SB2}		10	mA
ZZ active to input ignored		t_{PDS}	2		cycle
ZZ inactive to input sampled		t_{PUS}	2		cycle
ZZ active to SLEEP current		t_{ZZI}		2	cycle
ZZ inactive to exit SLEEP current		t_{RZZI}	0		

SLEEP MODE WAVEFORM

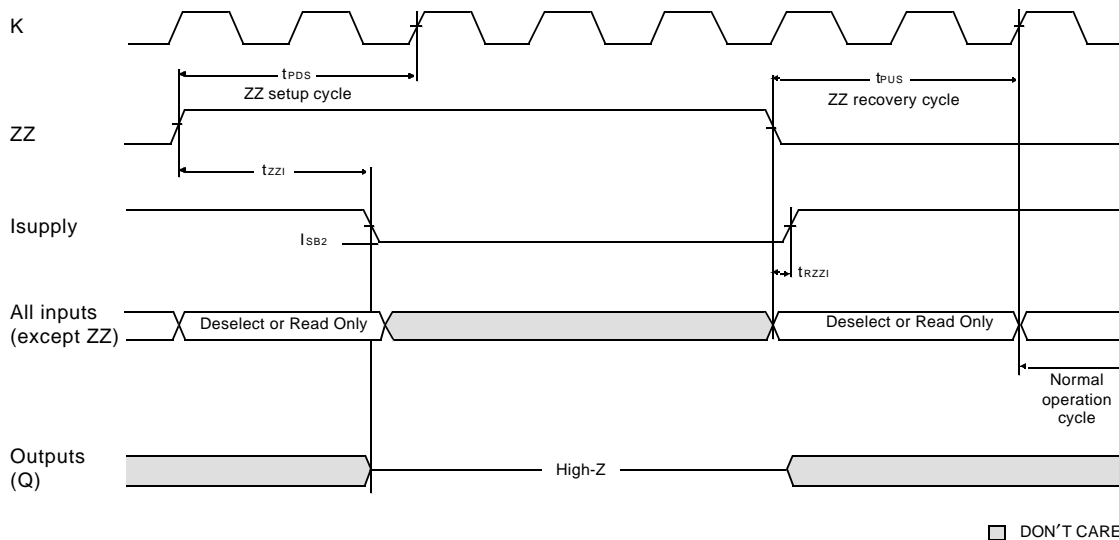

TIMING WAVEFORM OF READ CYCLE

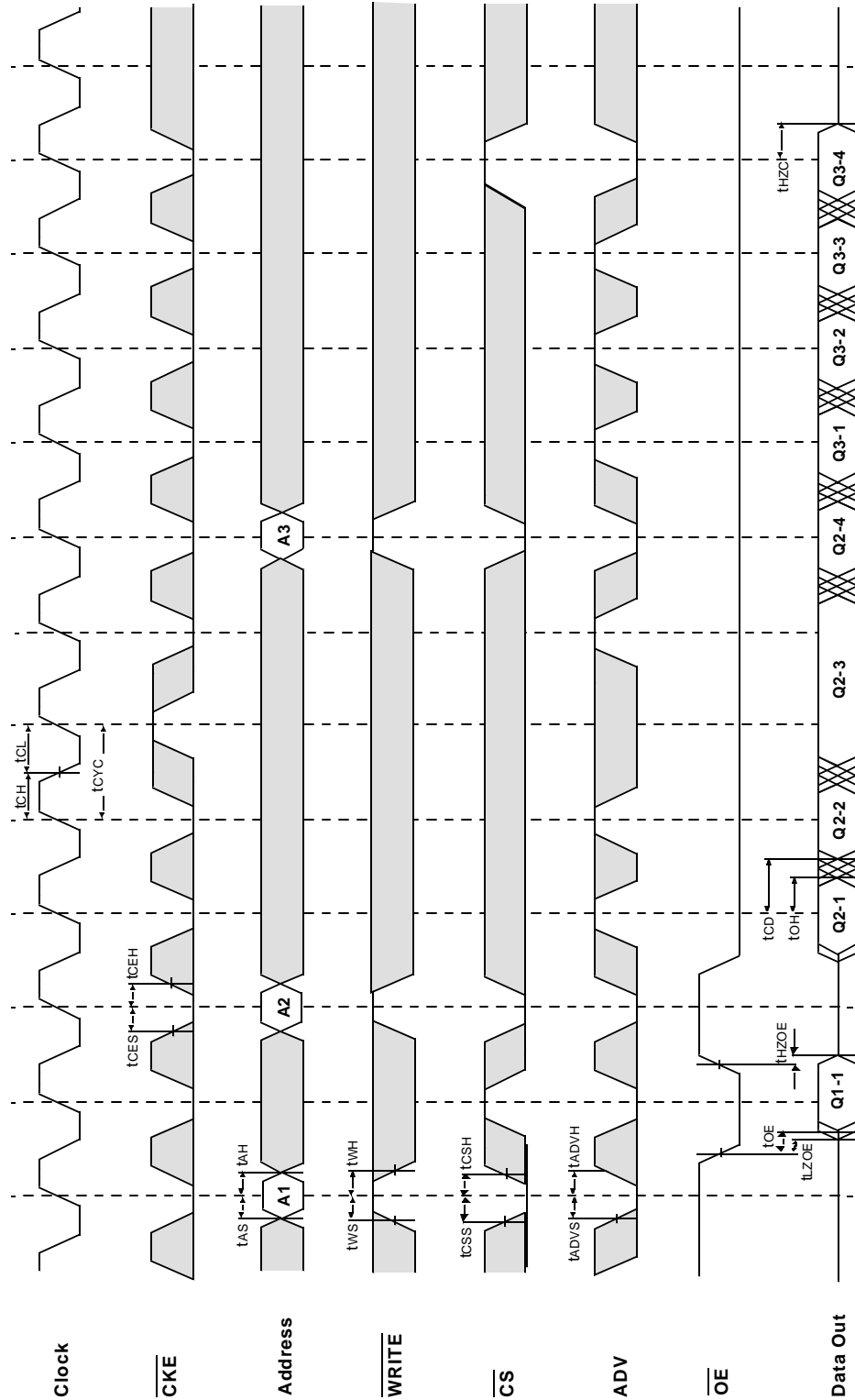

☐ Don't Care
☒ Undefined

NOTES : $\overline{WRITE} = L$ means $\overline{WE} = L$, and $\overline{BWx} = L$
 $\overline{CS} = L$ means $\overline{CS}_1 = L$, $\overline{CS}_2 = H$ and $\overline{CS}_2 = L$
 $\overline{CS} = H$ means $\overline{CS}_1 = H$, or $\overline{CS}_1 = L$ and $\overline{CS}_2 = H$, or $\overline{CS}_1 = L$, and $\overline{CS}_2 = L$

TIMING WAVEFORM OF WRTE CYCLE

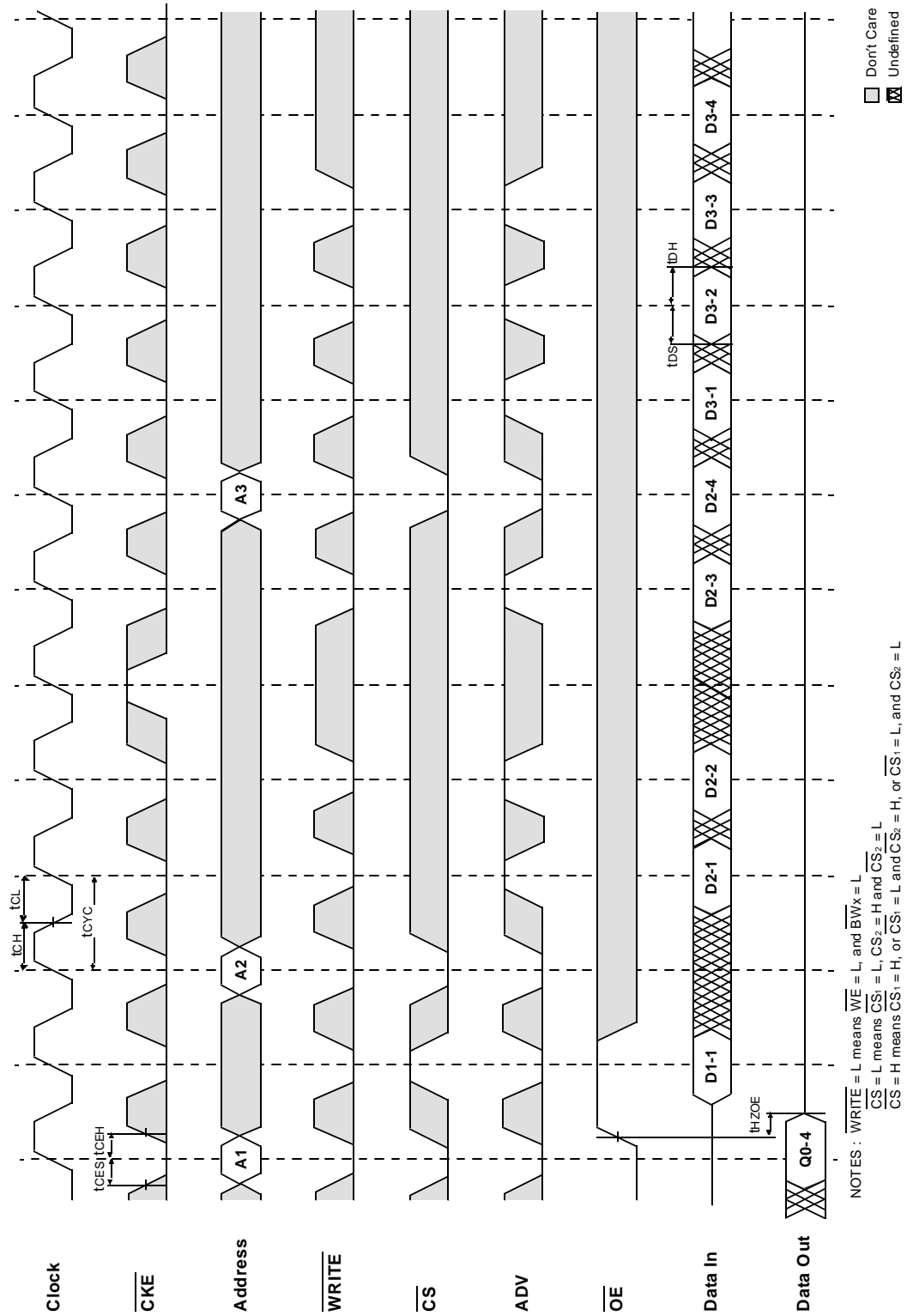

TIMING WAVEFORM OF SINGLE READ/WRITE

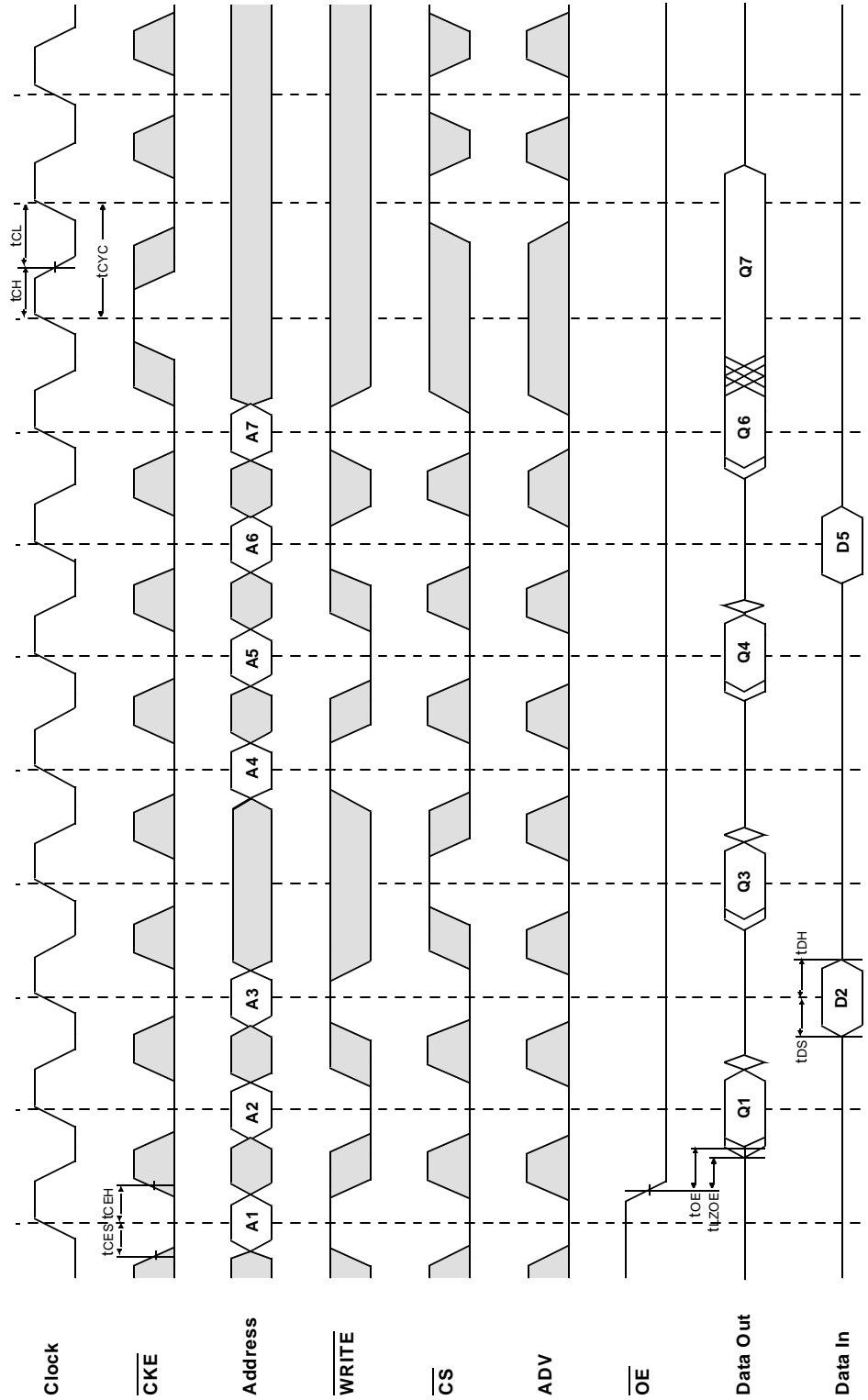

NOTES: $\overline{\text{WRITE}} = \text{L}$ means $\overline{\text{WE}} = \text{L}$, and $\overline{\text{BWx}} = \text{L}$.
 $\overline{\text{CS}} = \text{L}$ means $\overline{\text{CS}}_1 = \text{L}$, $\overline{\text{CS}}_2 = \text{H}$ and $\overline{\text{CS}}_2 = \text{L}$.
 $\overline{\text{CS}} = \text{H}$ means $\overline{\text{CS}}_1 = \text{H}$, or $\overline{\text{CS}}_1 = \text{L}$ and $\overline{\text{CS}}_2 = \text{H}$, or $\overline{\text{CS}}_1 = \text{L}$, and $\overline{\text{CS}}_2 = \text{L}$.

TIMING WAVEFORM OF $\overline{\text{CKE}}$ OPERATION

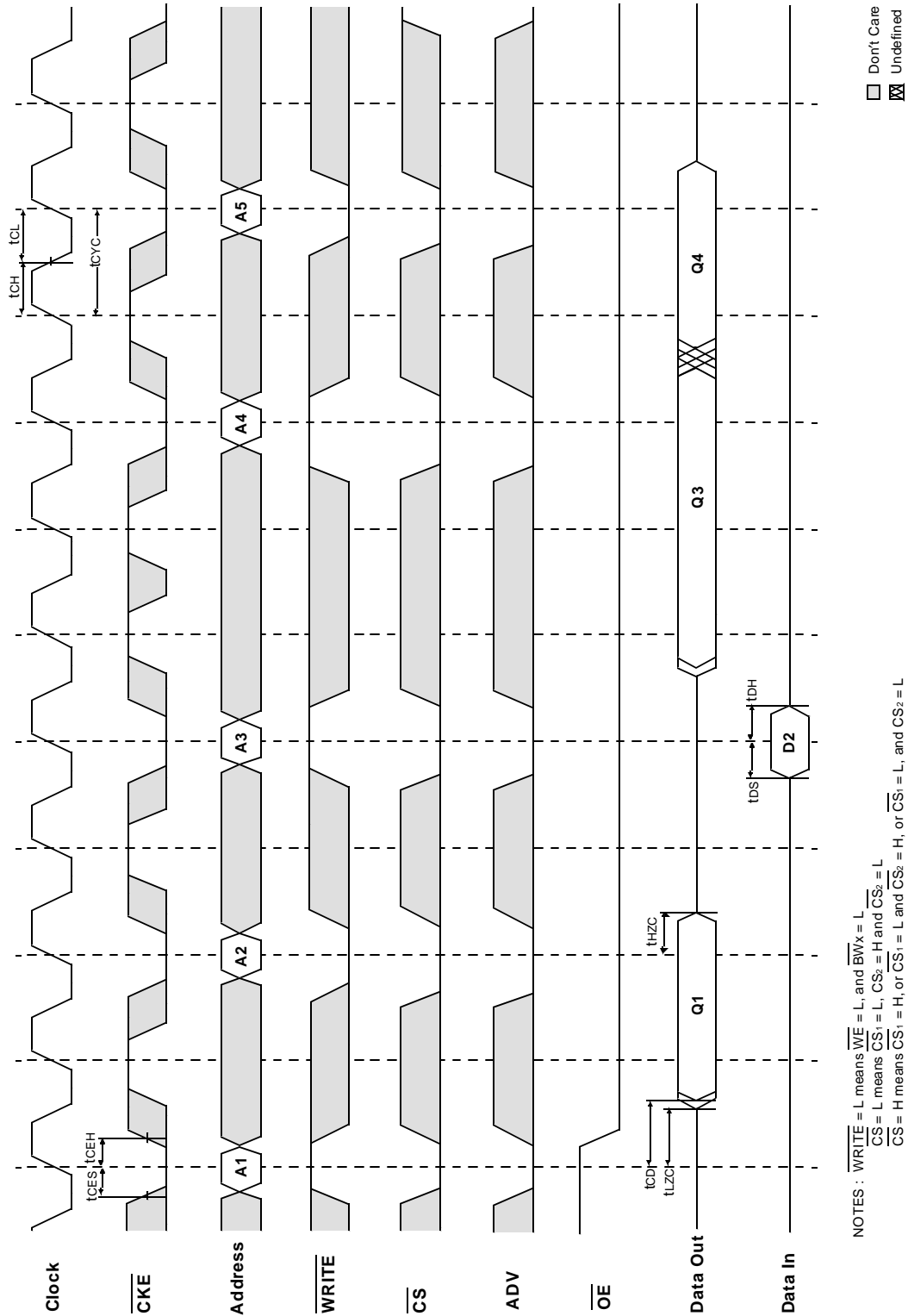

NOTES: $\overline{\text{WRITE}} = \text{L}$ means $\overline{\text{WE}} = \text{L}$, and $\overline{\text{BW}} = \text{L}$
 $\overline{\text{CS}} = \text{L}$ means $\overline{\text{CS}}_1 = \text{L}$, $\overline{\text{CS}}_2 = \text{H}$ and $\overline{\text{CS}}_2 = \text{L}$
 $\overline{\text{CS}} = \text{H}$ means $\overline{\text{CS}}_1 = \text{H}$, or $\overline{\text{CS}}_1 = \text{L}$ and $\overline{\text{CS}}_2 = \text{H}$, or $\overline{\text{CS}}_1 = \text{L}$, and $\overline{\text{CS}}_2 = \text{L}$

TIMING WAVEFORM OF CS OPERATION

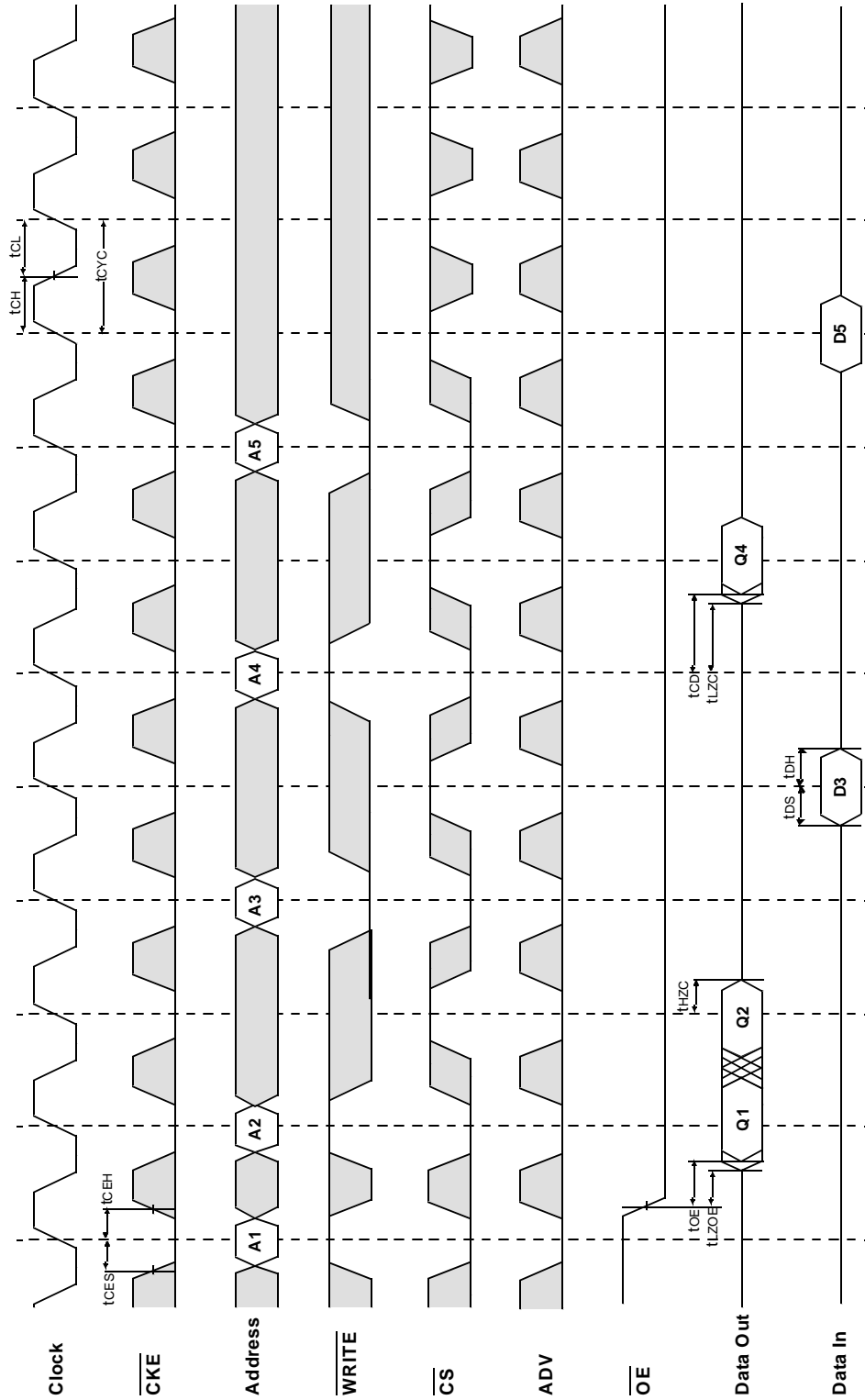

Don't Care
 Undefined

NOTES : $\overline{WRITE} = L$ means $\overline{WE} = L$, and $\overline{BWk} = L$
 $\overline{CS} = L$ means $\overline{CS}_1 = L$, $\overline{CS}_2 = H$ and $\overline{CS}_2 = L$
 $\overline{CS} = H$ means $\overline{CS}_1 = H$, or $\overline{CS}_1 = L$ and $\overline{CS}_2 = H$, or $\overline{CS}_1 = L$, and $\overline{CS}_2 = L$

**K7M163625M
K7M161825M**

512Kx36 & 1Mx18 Flow-Through NtRAM™

PACKAGE DIMENSIONS

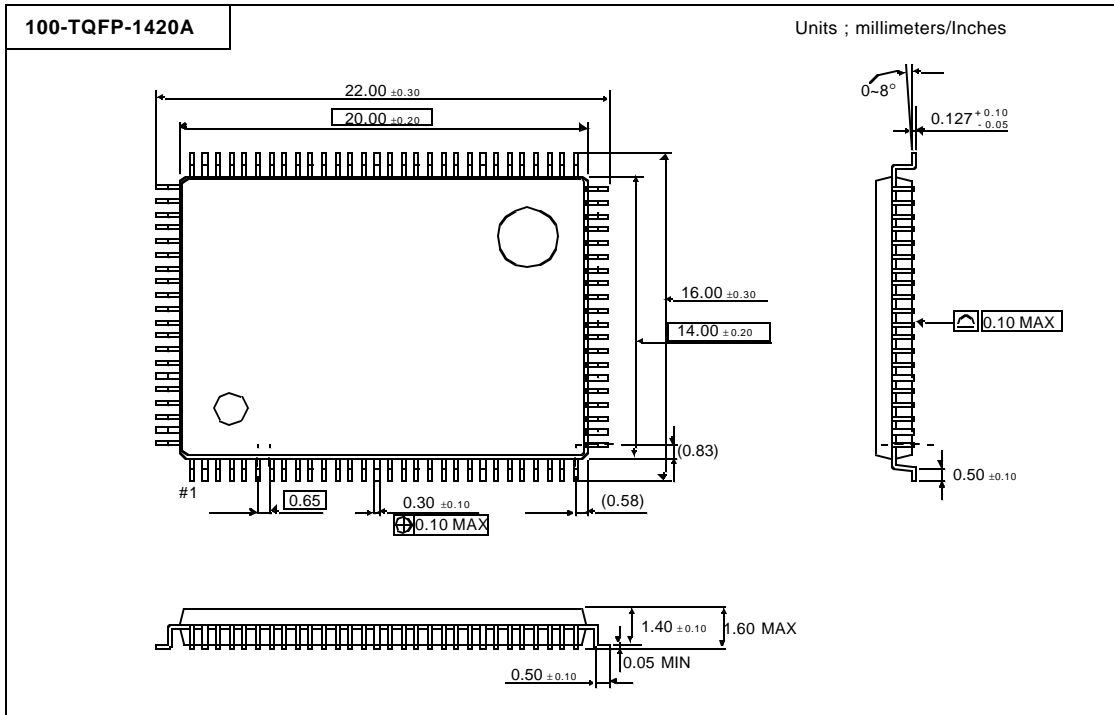

K7M163625M
K7M161825M

512Kx36 & 1Mx18 Flow-Through NtRAM™

119BGA PACKAGE DIMENSIONS

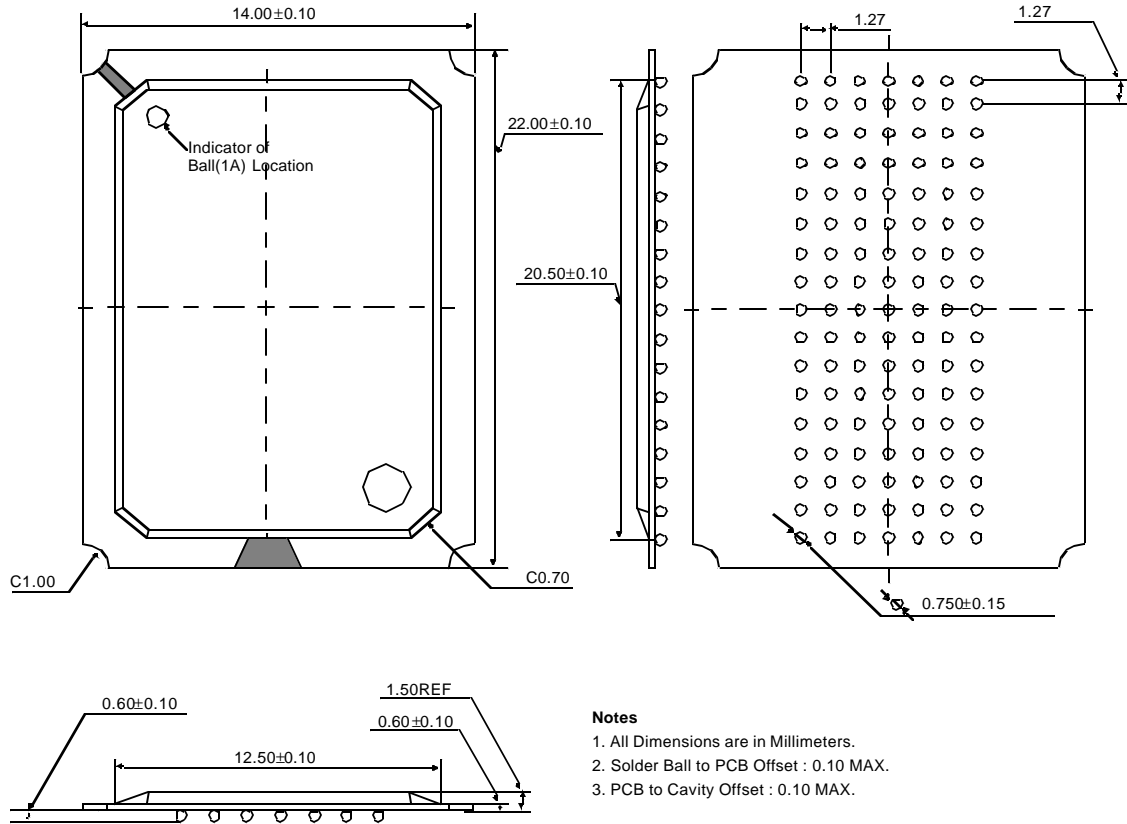

Notes

- 1. All Dimensions are in Millimeters.
- 2. Solder Ball to PCB Offset : 0.10 MAX.
- 3. PCB to Cavity Offset : 0.10 MAX.