

## EUK240 Series Power Modules; DC-DC Converters

### 36-60 Vdc Input; 9.6V Output; 240 W

### RoHS Compliant

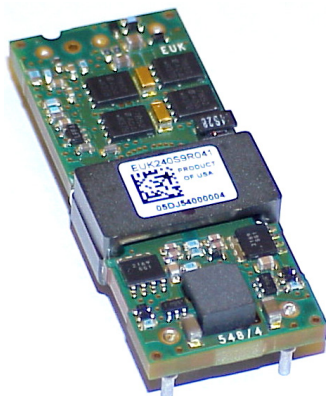

### Applications

- Distributed Power Architecture
- Wireless Networks
- Optical and Access Networks equipment
- Enterprise Networks

### Options

- Negative logic, Remote On/Off
- Pin length

### Description

The EUK240-series DC-DC converters are single-output power modules designed to support intermediate bus applications using discrete/modular point of load (POL) converters. The output is unregulated and a fixed 5:1 ratio is maintained between the input and output voltages. By taking advantage of the absence of regulation, high efficiency topologies operated at fixed duty cycles can be employed leading to low cost open frame modules. The output is fully isolated from the input, allowing versatile polarity configurations and grounding connections. The high efficiency of this converter leads to lower power dissipation. Built-in filtering for both input and output minimizes the need for external filtering. The module package dimensions are 59.7 mm x 23.6 mm x 11.0 mm (2.28 in x 0.93 in x 0.44 in.). Standard features include remote On/Off, input over-voltage, output over-current and over-temperature protection.

### Features

- Compliant to RoHS EU Directive 2002/95/EC (-Z versions)
- Compliant to ROHS EU Directive 2002/95/EC with lead solder exemption (non-Z versions)
- High efficiency – 96% at 9.6V, full load
- Excellent Thermal Performance:  
240W at Vin=55Vdc, 55°C at 1m/s (200LFM)  
240W at Vin=60Vdc, 60°C at 1.5m/s (300LFM)
- Industry standard Eighth brick:  
57.9 mm x 23.6mm x 11.0 mm  
(2.28 in x 0.93 in x 0.44 in)
- Cost-efficient open frame design
- Low output voltage ripple and noise
- Positive Remote On/Off logic
- Output over-current protection, auto-restart
- Input over-voltage protection, auto-restart
- Input under-voltage lockout
- Over-temperature protection, auto-restart
- Operating temperature range (-40°C to 85°C)
- ISO\*\* 9001 certified manufacturing facilities
- Basic Insulation (100% factory test to 1500Vdc)
- *UL\** 60950-1 Recognised, *CSA*<sup>†</sup> C22.2 No. 60950-1-03 Certified, and EN 60950-1 (*VDE*<sup>‡</sup> 0805: 2001-12) Licensed

\* *UL* is a registered trademark of Underwriters Laboratories, Inc.

<sup>†</sup> *CSA* is a registered trademark of Canadian Standards Association.

<sup>‡</sup> *VDE* is a trademark of Verband Deutscher Elektrotechniker e.V.

\*\* *ISO* is a registered trademark of the International Organization of Standards

## Absolute Maximum Ratings

Stresses in excess of the absolute maximum ratings can cause permanent damage to the device. These are absolute stress ratings only, functional operation of the device is not implied at these or any other conditions in excess of those given in the operations sections of the data sheet. Exposure to absolute maximum ratings for extended periods can adversely affect the device reliability.

Parameter	Device	Symbol	Min	Max	Unit
Input Voltage					
Continuous	All	$V_{IN}$	-0.3	60	Vdc
Non-Operating Condition	All		-0.3	75	Vdc
Operating Ambient Temperature	All	$T_A$	-40	85	°C
Storage Temperature	All	$T_{stg}$	-55	125	°C
I/O Isolation Voltage (100% factory tested)	All	$V_{iso}$	—	1500	Vdc

## Electrical Specifications

Unless otherwise indicated, specifications apply over all operating input voltage, resistive load, and temperature conditions.

Parameter	Device	Symbol	Min	Typ	Max	Unit
Operating Input Voltage	All	$V_{IN}$	36	48	60	Vdc
Maximum Input Current ( $V_{IN}=0$ to 60Vdc, $P_O=P_{O,max}$ )	All	$I_{IN,max}$			5	Adc
Inrush Transient	All	$I^2t$			1	A <sup>2</sup> s
Input Reflected Ripple Current, peak-to-peak (5Hz to 20MHz, 12 $\mu$ H source impedance; $T_a$ 25°C, $C_{in}$ = 33 $\mu$ F)	All		—	50	—	mAp-p
Input Ripple Rejection (120Hz)	All		—	14	—	dB

**CAUTION: This power module is not internally fused. An input line fuse must always be used.**

This power module can be used in a wide variety of applications, ranging from simple standalone operation to being part of complex power architecture. To preserve maximum flexibility, internal fusing is not included, however, to achieve maximum safety and system protection, always use an input line fuse. The safety agencies require a fast-acting fuse with a maximum rating of 15 A (see Safety Considerations section). Based on the information provided in this data sheet on inrush energy and maximum dc input current, the same type of fuse with a lower rating can be used. Refer to the fuse manufacturer's data sheet for further information.

### Electrical Specifications (continued)

Parameter	Device	Symbol	Min	Typ	Max	Unit
Output Voltage Set-point ( $V_{IN} = V_{IN, min}$ , $I_O = I_{O, max}$ , $T_A = 25^\circ\text{C}$ )	All	$V_{O, set}$		9.6		Vdc
Output Voltage (Over all line, load, and Temp Conditions Until end of life)	All	$V_O$	6.0	—	12.0	Vdc
Output Regulation Line ( $V_{IN} = V_{IN, min}$ to $V_{IN, max}$ )	All			—	4.2	V
Load ( $I_O = I_{O, min}$ to $I_{O, max}$ )	All		—	—	500	mV
Temperature ( $T_{ref} = T_{A, min}$ to $T_{A, max}$ )	All		—	—	200	mV
Output Ripple and Noise on nominal output ( $V_{IN} = V_{IN, nom}$ and $I_O = I_{O, min}$ to $I_{O, max}$ , $C_{out} = 1\mu\text{F}$ ceramic // $10\mu\text{F}$ Tantalum capacitor) RMS (5Hz to 20MHz bandwidth)	All		—	33	65	$\text{mV}_{rms}$
Peak-to-Peak (5Hz to 20MHz bandwidth)	All		—	100	150	$\text{mV}_{pk-pk}$
External Capacitance	All	$C_{O, max}$	0	—	5000	$\mu\text{F}$
Output Power		$P_O$			240	W
Output Current	All	$I_O$	0	—	34	A dc
Output Current Limit Inception (Hiccup Mode)	All	$I_{O, lim}$	—	32		A dc
Efficiency $V_{IN} = 48\text{V}$ , $T_A = 25^\circ\text{C}$ , $I_O = I_{O, max}$	All	$\eta$	—	96	—	%
Switching Frequency	All	$f_{sw}$	130		240	KHz
Dynamic Load Response ( $di_O/dt = 0.1\text{A}/\mu\text{s}$ ; $V_{IN} = V_{IN, nom}$ ; $T_A = 25^\circ\text{C}$ ) Load Change from $I_O = 50\%$ to $75\%$ of $I_{O, max}$						
Peak Deviation	All	$V_{pk}$	—	400	—	mV
Settling Time ( $V_O < 10\%$ peak deviation)	All	$t_s$	—	0.2	—	ms
Load Change from $I_O = 50\%$ to $25\%$ of $I_{O, max}$						
Peak Deviation	All	$V_{pk}$	—	400	—	mV
Settling Time ( $V_O < 10\%$ peak deviation)	All	$t_s$	—	0.2	—	ms

### Isolation Specifications

Parameter	Min	Typ	Max	Unit
Isolation Capacitance	—	1000	—	pF
Isolation Resistance	10	—	—	$\text{M}\Omega$

### General Specifications

Parameter	Min	Typ	Max	Unit
Calculated MTBF ( $I_O = 80\%$ of $I_{O, max}$ , $T_A = 40^\circ\text{C}$ )		2,511,340	—	Hours
Weight	—	32.5 (1.15)	—	g (oz.)

## Feature Specifications

Unless otherwise indicated, specifications apply over all operating input voltage, resistive load, and temperature conditions. See Feature Descriptions for additional information.

Parameter	Device	Symbol	Min	Typ	Max	Unit
Remote On/Off Signal Interface ( $V_{IN}=V_{IN, min}$ to $V_{IN, max}$ ; open collector or equivalent, Signal referenced to $V_{IN}$ -terminal) Negative Logic: device code suffix "1" Logic Low = module On, Logic High = module Off Positive Logic: No device code suffix required Logic Low = module Off, Logic High = module On						
Logic Low - Remote On/Off Current	All	$I_{on/off}$	—	—	1.0	mA
Logic Low - On/Off Voltage	All	$V_{on/off}$	-0.3	—	0.8	V <sub>dc</sub>
Logic High Voltage – (Typ = Open Collector)	All	$V_{on/off}$	2.0	—	4.7	V <sub>dc</sub>
Logic High maximum allowable leakage current ( $V_{on/off} = 2.0V$ )	All	$I_{on/off}$	—	—	0.7	mA
Maximum voltage allowed on On/Off pin		$V_{on/off}$	—	—	13.5	V <sub>dc</sub>
Turn-On Delay and Rise Times ( $I_O=80\% I_{O, max}$ , $T_A = 25^\circ C$ )						
Case 1: On/Off input is set to Logic High and then input power is applied (delay from instant at which $V_{IN} = V_{IN, min}$ until $V_o=10\%$ of $V_{o,nom}$ )	All	$T_{delay}$	—	10	—	msec
Case 2: Input power is applied for at least one second and then the On/Off input is set to logic high (delay from instant at which $V_{on/off} = 0.9V$ until $V_o=10\%$ of $V_{o, set}$ )	All	$T_{delay}$	—	8	—	msec
Output voltage Rise time (time for $V_o$ to rise from 10% of $V_{o, nom}$ to 90% of $V_{o, nom}$ )	All	$T_{rise}$	—	5	—	msec
Output voltage overshoot – Startup $I_O= 80\%$ of $I_{O, max}$ ; $T_A = 25^\circ C$						
	All		—	—	400	mV
Input Under-voltage Lockout						
Turn-on Threshold		$V_{UVLO}$	—	34	35.5	V
Turn-off Threshold			32.0	35	—	V
Input Over voltage Protection						
	All	$V_{I, prot}$	—	63	65	V
Over temperature protection						
	All		—	125	—	$^\circ C$

### Characteristic Curves

The following figures provide typical characteristics for EUK240S9R0 at  $T_A = 25^\circ\text{C}$

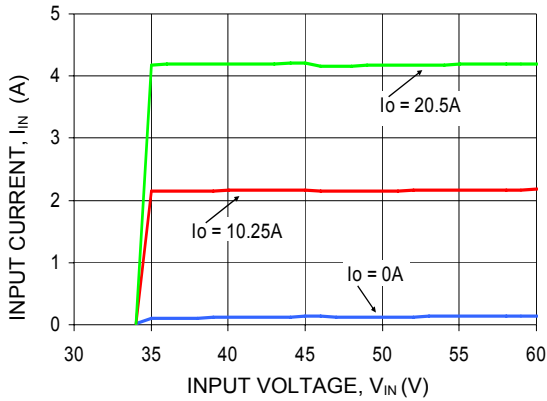

Figure 1. Typical Input characteristics at room temperature .

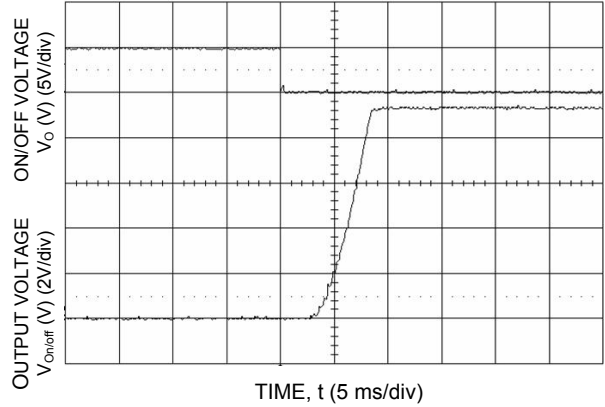

Figure 4. Typical Start-Up Characteristics from Remote ON/OFF.

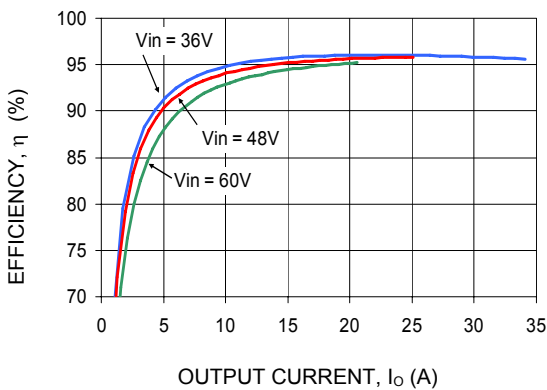

Figure 2. Typical Converter Efficiency versus Output Current at room temperature.

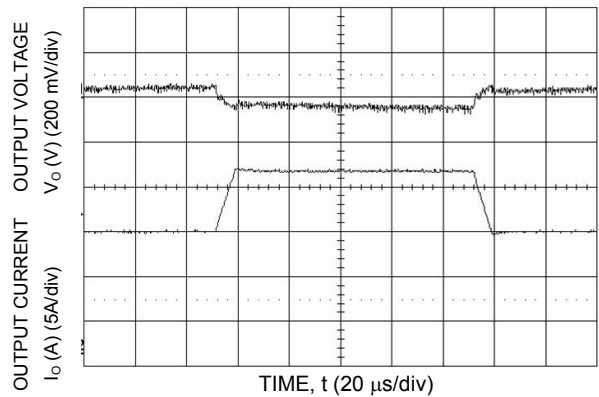

Figure 5. Transient Response to a Dynamic Load Change from 50% to 75% 50% of full load.

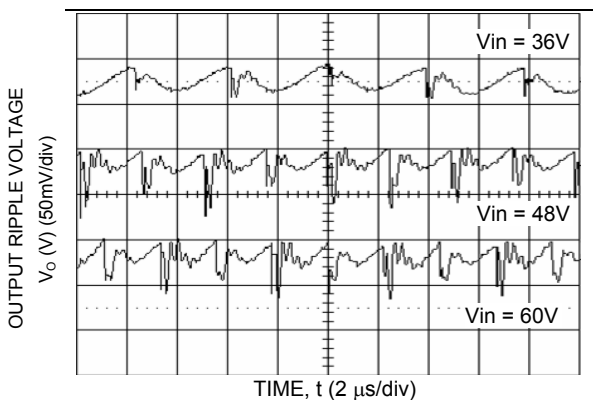

Figure 3. Output ripple voltage at full load and minimum, nominal and maximum input voltage.

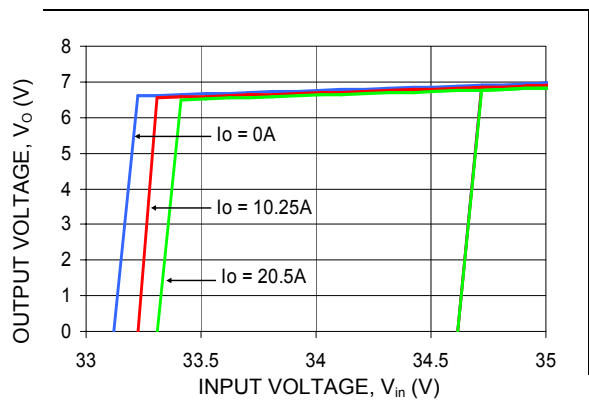

Figure 6. Typical Output Voltage start up vs. Input Voltage Characteristic at Room Temperature.

Characteristic Curves (continued)

The following figures provide typical characteristics for EUK240S9R0 at  $T_A = 25^\circ\text{C}$

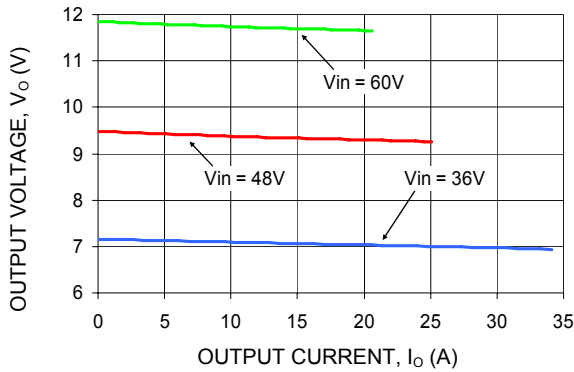

Figure 7. Typical Output Voltage vs. Output Current Characteristic at Room Temperature.

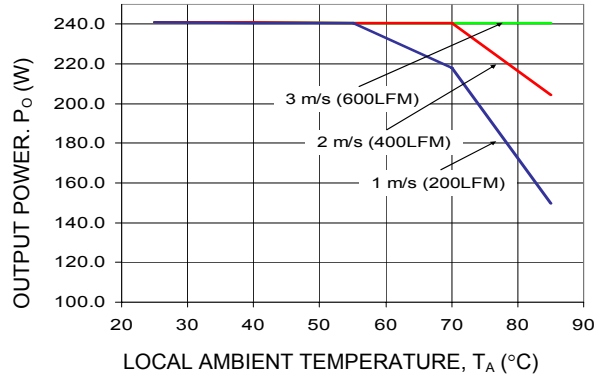

Figure 10. Thermal derating of the module in the Transverse Orientation; Airflow Direction from Vin(-) to Vin(+); Vin = 48V.

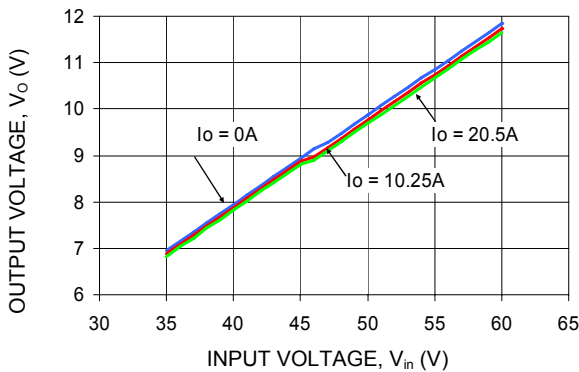

Figure 8. Typical Output Voltage vs. Input Voltage Characteristic at Room Temperature.

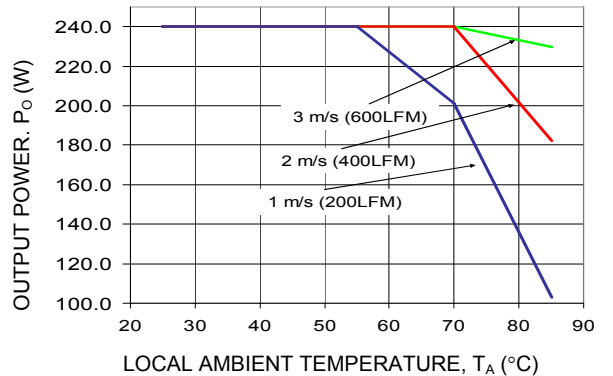

Figure 11. Thermal derating of the module in the Transverse Orientation; Airflow Direction from Vin(-) to Vin(+); Vin = 55V.

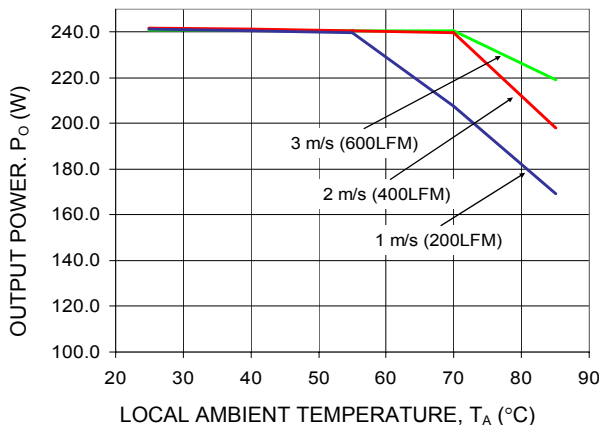

Figure 9. Thermal derating of the module in the Transverse Orientation; Airflow Direction from Vin(-) to Vin(+); Vin = 38V.

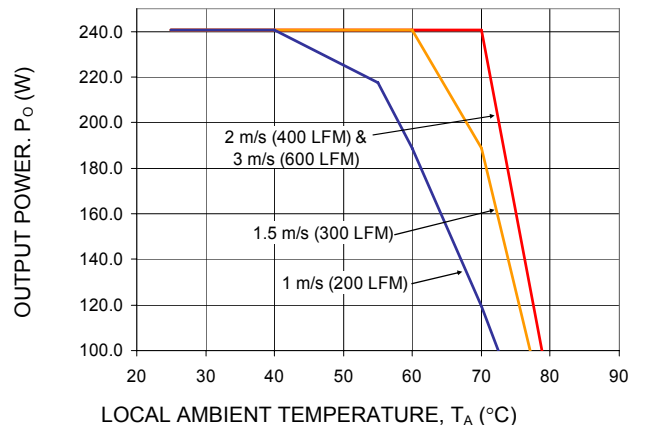
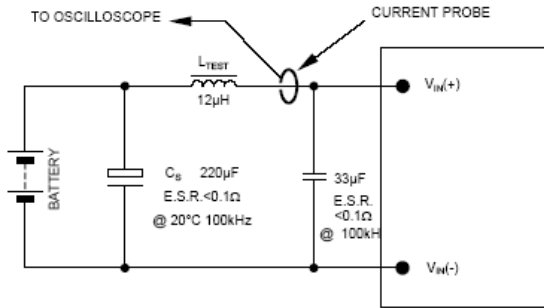

Figure 12. Thermal derating of the module in the Transverse Orientation; Airflow Direction from Vin(-) to Vin(+); Vin = 60V.

### Test Configurations



NOTE: Measure input reflected ripple current with a simulated source inductance ( $L_{TEST}$ ) of 12µH. Capacitor  $C_B$  offsets possible battery impedance. Measure current as shown above.

Figure 13. Input Reflected Ripple Current Test Setup.

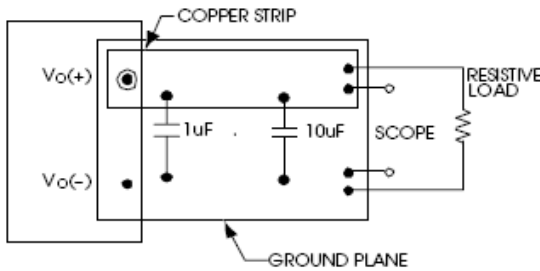

NOTE: All voltage measurements to be taken at the module terminals, as shown above. If sockets are used then Kelvin connections are required at the module terminals to avoid measurement errors due to socket contact resistance.

Figure 14. Output Ripple and Noise Test Setup.

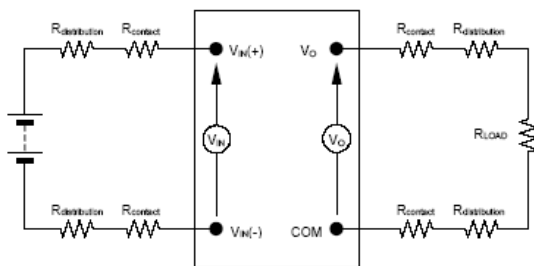

NOTE: All voltage measurements to be taken at the module terminals, as shown above. If sockets are used then Kelvin connections are required at the module terminals to avoid measurement errors due to socket contact resistance.

Figure 15. Output Voltage and Efficiency Test Setup.

$$\text{Efficiency } \eta = \frac{V_O \cdot I_O}{V_{IN} \cdot I_{IN}} \times 100 \%$$

### Safety Considerations

For safety agency approval the power module must be installed in compliance with the spacing and separation requirements of the end-use safety agency standards, i.e., UL 60950-1, CSA C22.2 No. 60950-1-03, and EN60950-1 (VDE 0850) (IEC60950, 3<sup>rd</sup> edition) Licensed. The power modules meet the 73/23/EEC and 93/68/EEC Directives and will be marked with the Conformance Europeane (CE) mark.

For the converter output to be considered meeting the requirements of safety extra-low voltage (SELV), the input must meet SELV requirements.

The input to these units is to be provided with a fast-acting fuse with a maximum rating of 15 A in the ungrounded lead.

## Feature Description

### Remote On/Off

Two remote on/off options are available. Positive logic remote on/off turns the module on during a logic-high voltage on the ON/OFF pin, and off during logic low. Negative logic remote on/off turns the module off during a logic high and on during a logic low. Negative logic, device code suffix "1," is the factory-preferred configuration. To turn the power module on and off, the user must supply a switch to control the voltage between the on/off terminal and the VI (-) terminal (Von/off). The switch can be an open collector or equivalent (see Figure 16). A logic low is Von/off = -0.3 V to 0.8 V. The maximum Ion/off during a logic low is 10 mA. The switch should maintain a logic-low voltage while sinking 10 mA. During logic high, the maximum Von/off generated by the power module is 4.7 V. The maximum allowable leakage current of the switch at Von/off = 2.0V is 0.7 mA. If not using the remote on/off feature, perform one of the following to turn the unit on:

For negative logic, short ON/OFF pin to VI(-).

For positive logic: leave ON/OFF pin open.

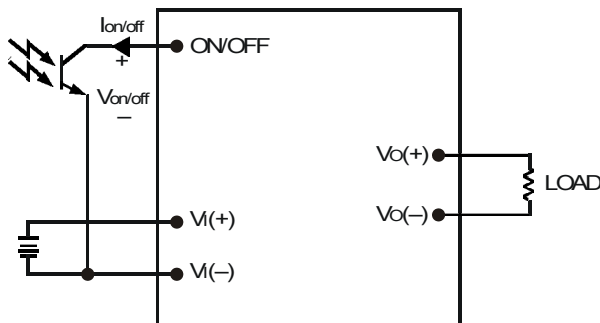

**Figure 16. Circuit configuration for using Remote On/Off Implementation.**

### Over-current Protection

To provide protection in an output overload condition, the module is equipped with internal current-limiting circuitry and can endure current limiting for unlimited duration. If the output current exceeds the current limit inception value, the module enters into the hiccup (auto-restart) mode operation, where it shuts down and automatically attempts to restart. As long as the fault condition exists, the module will remain in this hiccup mode, and can sustain this mode of operation until the over-current fault condition is corrected.

### Input Under-voltage Lockout

At input voltages below the input under voltage lockout limit, the module operation is disabled. The module will begin to operate at an input voltage above the under voltage lockout turn-on threshold.

### Over-temperature Protection

These modules feature an over-temperature protection circuit to safeguard against thermal damage. The protection circuit shuts down the module when the maximum device reference temperature is exceeded. When the module cools down and the reference device temperature falls below the recovery threshold, the module will resume operation.

### Over-voltage Protection

The input/output over-voltage protection circuit is designed to shut down the module when the input voltage exceeds the over-voltage threshold. The module will resume operation when the input voltage enters the normal input operating range.

### Short Circuit Protection

The power modules shall sustain no damage when subjected to a short circuit of any duration on its output. The output of the module shall recover automatically in a hiccup (auto-restart) manner identical to that described in the over-current protection section.

### Pre-Bias Immunity

The startup/shutdown characteristics of the module accommodates external voltage source clamping on the output via external diodes without exhibiting non-monotonic startup (See figure 17). The monotonic startup of the module will not be affected by the customer application of the pre-biasing of the output. During shutdown an internal feature implemented in the module ensures there will be no reverse current. During Hiccup operation, the reverse current protection will be enabled.

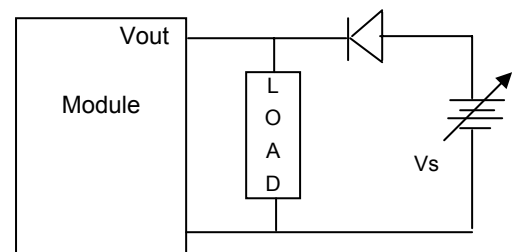

**Figure 17. Pre-bias immunity configuration.**



### Thermal Considerations

Power modules operate in a variety of thermal environments; however, sufficient cooling should be provided to help ensure reliable operation. Considerations include ambient temperature, airflow, module power dissipation, and the need for increased reliability. A reduction in the operating temperature of the module will result in an increase in reliability. The thermal data is based on physical measurements taken in a wind tunnel. The test set-up is shown in Figure 18. The module delivers full power over an input voltage range of 36V to 55V, at an ambient temperature of 55°C, at the airflow rate of 200LFM environment, at sea level, at 50 % relative humidity, with specified orientation. For higher local ambient temperature operation, the modules output power should be derated, as shown in Figures 9 - 12.

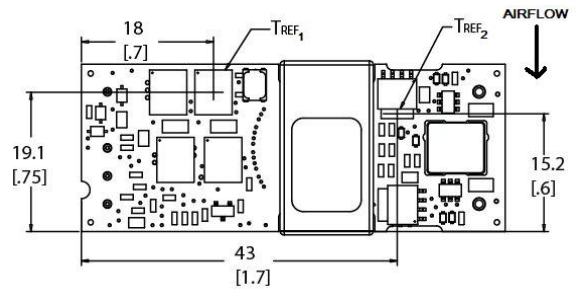

Figure 19. Temperature Measurement Locations

Please refer to the Application Note “Thermal Characterization Process For Open-Frame Board-Mounted Power Modules” for a detailed discussion of thermal aspects including maximum device temperatures.

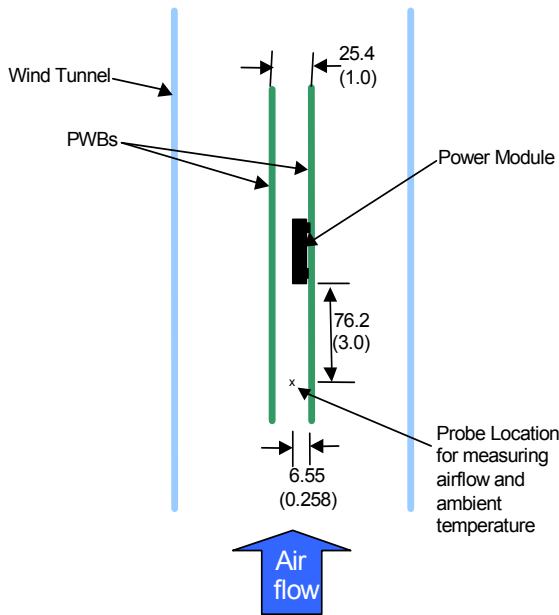

Figure 18. Thermal Test Set up.

## Post Solder Cleaning and Drying Considerations

Post solder cleaning is usually the final circuit-board assembly process prior to electrical board testing. The result of inadequate cleaning and drying can affect both the reliability of a power module and the testability of the finished circuit-board assembly. For guidance on appropriate soldering, cleaning and drying procedures, refer to Lineage Power *Board Mounted Power Modules: Soldering and Cleaning* Application Note (AP01-056EPS).

## Through-Hole Lead-Free Soldering Information

The RoHS-compliant through-hole products use the SAC (Sn/Ag/Cu) Pb-free solder and RoHS-compliant components. They are designed to be processed through single or dual wave soldering machines. The pins have an RoHS-compliant finish that is compatible with both Pb and Pb-free wave soldering processes. A maximum preheat rate of 3°C/s is suggested. The wave preheat process should be such that the temperature of the power module board is kept below 210°C. For Pb solder, the recommended pot temperature is 260°C, while the Pb-free solder pot is 270°C max. Not all RoHS-compliant through-hole products can be processed with paste-through-hole Pb or Pb-free reflow process. If additional information is needed, please consult with your Lineage Power representative for more details.

### Mechanical Outline

Dimensions are in millimeters and [inches].

Tolerances:  $x.x \text{ mm} \pm 0.5 \text{ mm}$  [ $x.xx \text{ in.} \pm 0.02 \text{ in.}$ ] (Unless otherwise indicated)

$x.xx \text{ mm} \pm 0.25 \text{ mm}$  [ $x.xxx \text{ in.} \pm 0.010 \text{ in.}$ ]

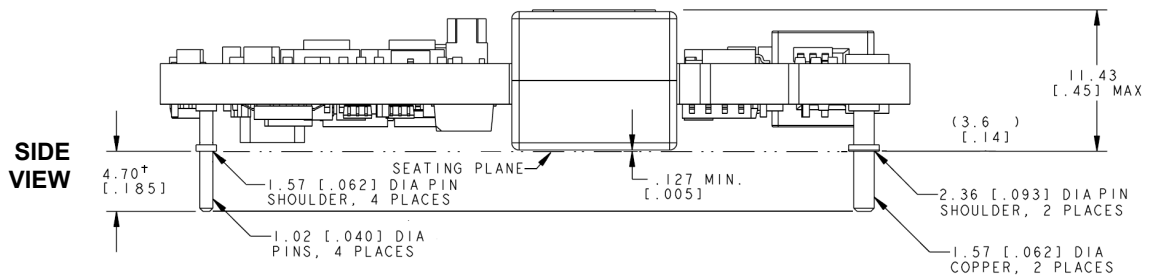
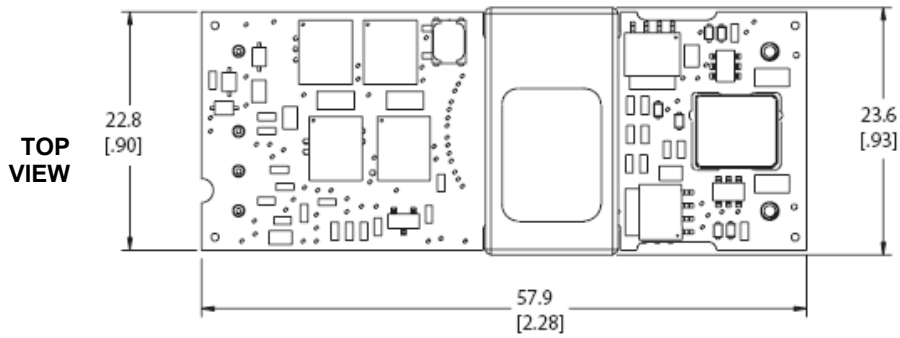

† Optional pin lengths shown in Table 2, Device Options.

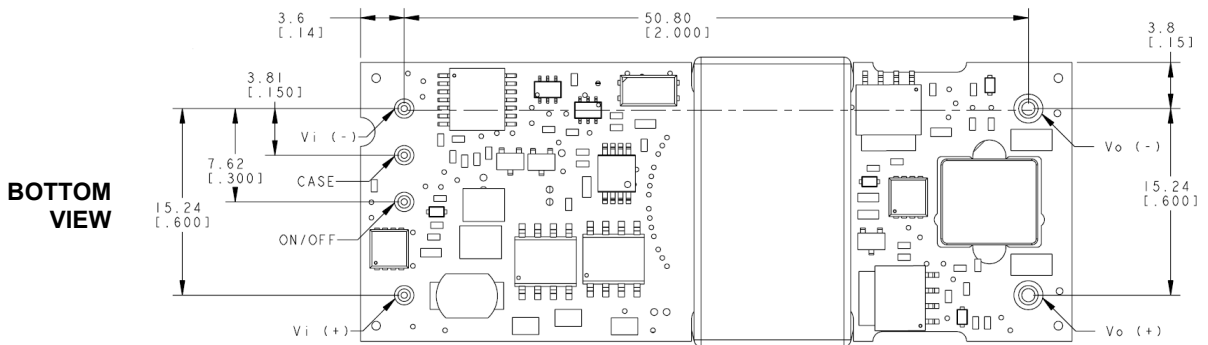

### Recommended Pad Layout

Dimensions are in millimeters and [inches].

Tolerances: x.xx mm ± 0.5 mm [x.xx in. ± 0.02 in.] (Unless otherwise indicated)

x.xx mm ± 0.25 mm [x.xxx in ± 0.010 in.]

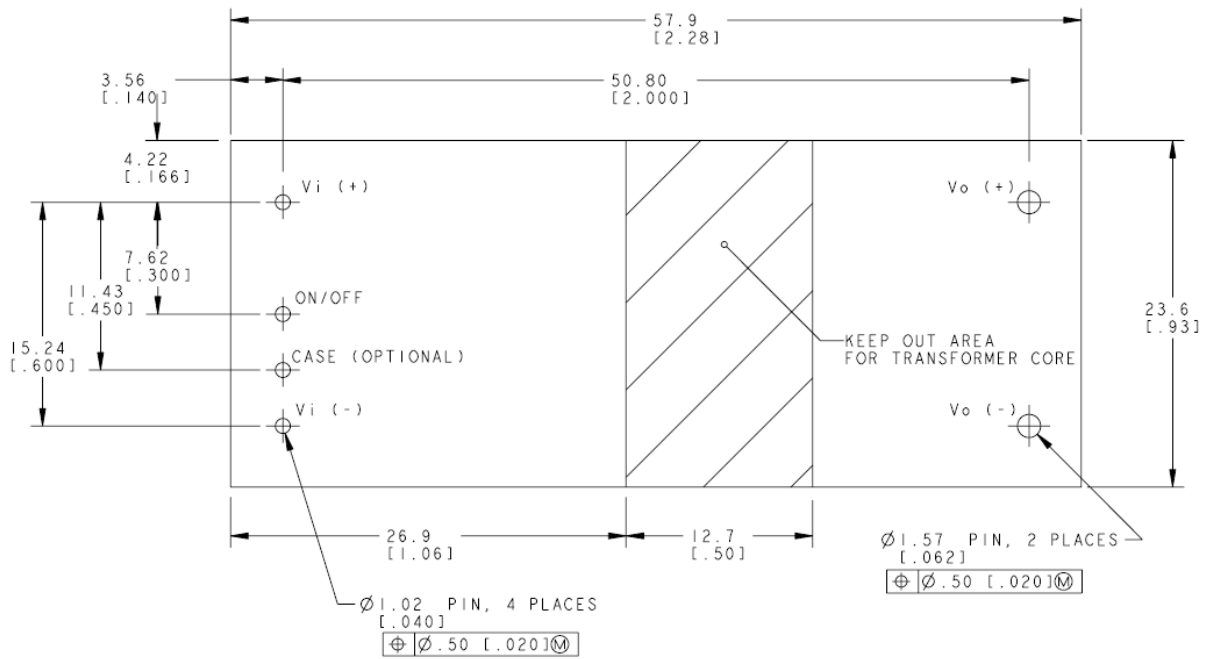

## Ordering Information

Please contact your Lineage Power Sales Representative for pricing, availability and optional features.

**Table 1. Device Codes**

Product codes	Input Voltage	Output Voltage	Output Power	Efficiency	Connector Type	Comcodes
EUK240S9R041Z	36-60 Vdc	9.6V	240W	96%	Through hole	CC109114294
EUK240S9R0641Z	36-60 Vdc	9.6V	240W	96%	Through hole	CC109143525

-Z indicates RoHS Compliant modules

**Table 2. Device Options**

Option	Suffix
Negative remote on/off logic	1
Auto-restart (must be ordered)	4
Pin Length: 3.68 mm ± 0.25mm , (0.145 in. ± 0.010 in.)	6
Pin Length: 2.79 mm ± 0.25mm , (0.110 in. ± 0.010 in.)	8



**LINEAGE POWER**

**World Wide Headquarters**  
**Lineage Power Corporation**  
3000 Skyline Drive, Mesquite, TX 75149, USA  
**+1-800-526-7819**  
(Outside U.S.A.: **+1-972-284-2626**)  
**www.lineagepower.com**  
**e-mail: techsupport1@lineagepower.com**

**Asia-Pacific Headquarters**  
Tel: +65 6416 4283

**Europe, Middle-East and Africa Headquarters**  
Tel: +49 89 6089 286

**India Headquarters**  
Tel: +91 80 28411633

Lineage Power reserves the right to make changes to the product(s) or information contained herein without notice. No liability is assumed as a result of their use or application. No rights under any patent accompany the sale of any such product(s) or information.

© 2008 Lineage Power Corporation, (Mesquite, Texas) All International Rights Reserved.