

NPN DARLINGTON POWER MODULE

- HIGH CURRENT POWER BIPOLAR MODULE
- VERY LOW R_{th} JUNCTION CASE
- SPECIFIED ACCIDENTAL OVERLOAD AREAS
- ULTRAFAST FREEWHEELING DIODE
- ISOLATED CASE (2500V RMS)
- EASY TO MOUNT
- LOW INTERNAL PARASITIC INDUCTANCE

INDUSTRIAL APPLICATIONS:

- MOTOR CONTROL
- UPS
- DC/DC & DC/AC CONVERTERS

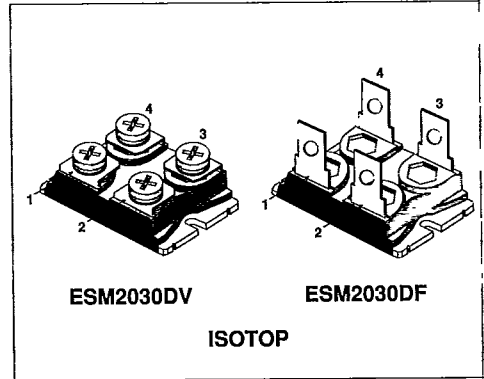

INTERNAL SCHEMATIC DIAGRAM

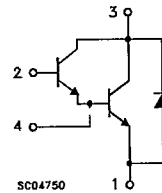

ABSOLUTE MAXIMUM RATINGS

Symbol	Parameter	Value	Unit
V_{CEV}	Collector-Emitter Voltage ($V_{BE} = -5$ V)	400	V
$V_{CEO(sus)}$	Collector-Emitter Voltage ($I_B = 0$)	300	V
V_{EBO}	Emitter-Base Voltage ($I_C = 0$)	7	V
I_C	Collector Current	67	A
I_{CM}	Collector Peak Current ($t_p = 10$ ms)	100	A
I_B	Base Current	3	A
I_{BM}	Base Peak Current ($t_p = 10$ ms)	6	A
P_{tot}	Total Dissipation at $T_c = 25$ °C	150	W
T_{stg}	Storage Temperature	-55 to 150	°C
T_j	Max. Operating Junction Temperature	150	°C
V_{iso}	Insulation Withstand Voltage (AC-RMS)	2500	V

THERMAL DATA

T-33-35

R _{thj-case}	Thermal Resistance Junction-case (transistor)	Max	0.83	°C/W
R _{thj-case}	Thermal Resistance Junction-case (diode)	Max	1.2	°C/W
R _{thc-h}	Thermal Resistance Case-heatsink With Conductive Grease Applied	Max	0.05	°C/W

ELECTRICAL CHARACTERISTICS (T_{case} = 25 °C unless otherwise specified)

Symbol	Parameter	Test Conditions	Min.	Typ.	Max.	Unit
I _{CEr} #	Collector Cut-off Current (R _{BE} = 5 Ω)	V _{CE} = V _{CEV} V _{CE} = V _{CEV} T _J = 100 °C			1.5 16	mA mA
I _{CEV} #	Collector Cut-off Current (V _{BE} = -5V)	V _{CE} = V _{CEV} V _{CE} = V _{CEV} T _J = 100 °C			1 11	mA mA
I _{EBO} #	Emitter Cut-off Current (I _C = 0)	V _{EB} = 5 V			1	mA
V _{CE0(SUS)} *	Collector-Emitter Sustaining Voltage	I _C = 0.2 A L = 25 mH V _{olamp} = 300 V	300			V
h _{FE} *	DC Current Gain	I _C = 56 A V _{CE} = 5 V		300		
V _{CE(sat)} *	Collector-Emitter Saturation Voltage	I _C = 40 A I _B = 0.4 A I _C = 40 A I _B = 0.4 A T _J = 100 °C I _C = 56 A I _B = 1.6 A I _C = 56 A I _B = 1.6 A T _J = 100 °C		1.25 1.4 1.5 1.8	1.8 2.2	V V V V
V _{BE(sat)} *	Base-Emitter Saturation Voltage	I _C = 56 A I _B = 1.6 A I _C = 56 A I _B = 1.6 A T _J = 100 °C		2.4 2.5	3	V V
dic/dt	Rate of Rise of On-state Collector	V _{CC} = 300 V R _C = 0 t _p = 3 μs I _{B1} = 0.6 A T _J = 100 °C	220	260		A/μs
V _{CE(3 μs)}	Collector-Emitter Dynamic Voltage	V _{CC} = 300 V R _C = 7.5 Ω I _{B1} = 0.6 A T _J = 100 °C		3	6	V
V _{CE(5 μs)}	Collector-Emitter Dynamic Voltage	V _{CC} = 300 V R _C = 7.5 Ω I _{B1} = 0.6 A T _J = 100 °C		2.2	4	V
t _s t _f t _c	Storage Time Fall Time Cross-over Time	I _C = 40 A V _{CC} = 50 V V _{BB} = -5 V R _{BB} = 0.6 Ω V _{olamp} = 300 V I _{B1} = 0.4 A L = 0.06 mH T _J = 100 °C		2 0.35 0.8	3 0.6 1.2	μs μs μs
V _{CEW}	Maximum Collector Emitter Voltage Without Snubber	I _{CWoff} = 67 A I _{B1} = 1.6 A V _{BB} = -5 V V _{CC} = 50 V L = 0.037 mH R _{BB} = 0.6 Ω T _J = 125 °C	300			V
V _F *	Diode Forward Voltage	I _F = 56 A T _J = 100 °C		1.15	1.4	V
I _{RM}	Reverse Recovery Current	V _{CC} = 200 V I _F = 56 A di _F /dt = -220 A/μs L < 0.05 μH T _J = 100 °C		12	17	A

* Pulsed: Pulse duration = 300 μs, duty cycle 1.5 %

See test circuit in databook introduction

To evaluate the conduction losses of the diode use the following equations:

$$V_F = 1.1 + 0.0045 I_F \quad P = 1.1 I_{F(AV)} + 0.0045 I_{F(RMS)}^2$$

Safe Operating Areas

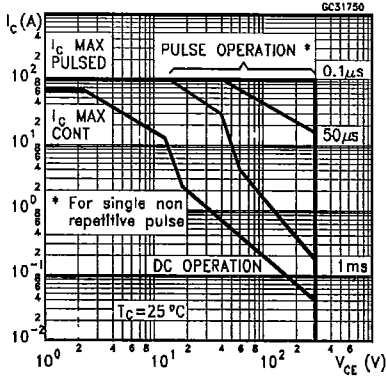

Thermal Impedance

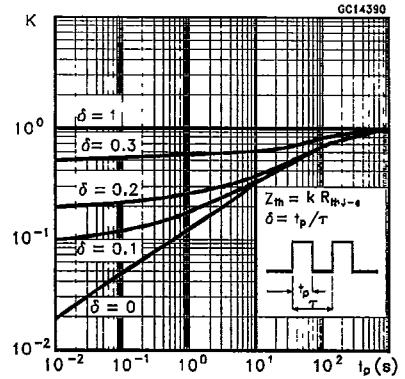

Derating Curve

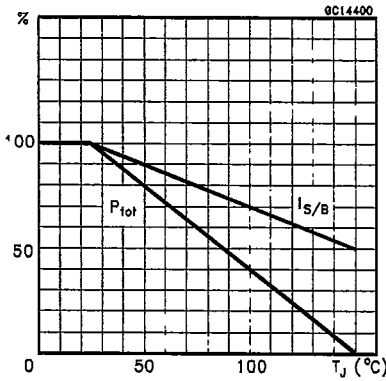

Collector-Emitter Voltage Versus Base-Emitter Resistance

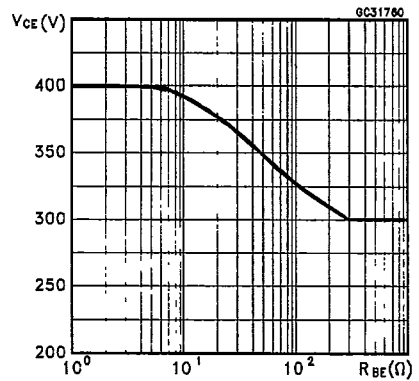

Collector-Emitter Saturation Voltage

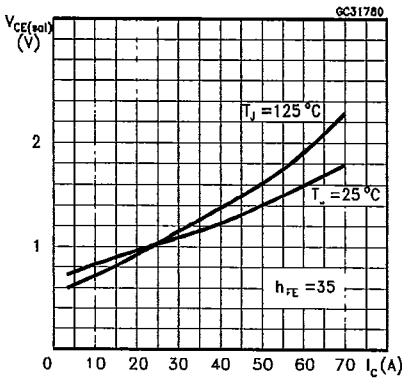

Base-Emitter Saturation Voltage

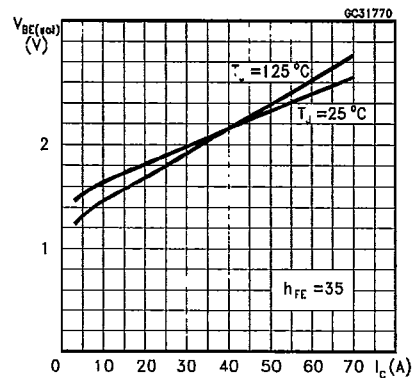

Reverse Biased SOA

Forward Biased SOA

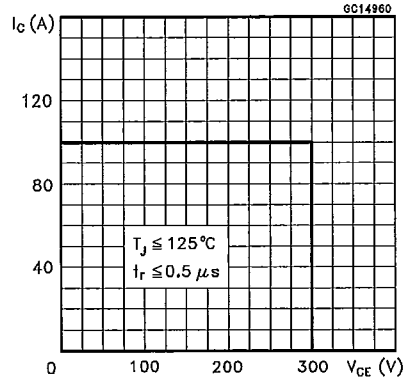
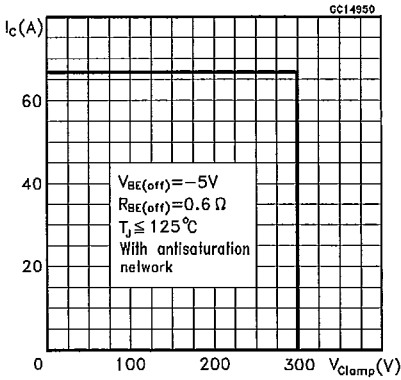

Reverse Biased AOA

Forward Biased AOA

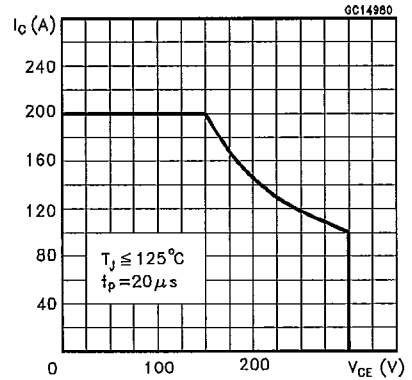
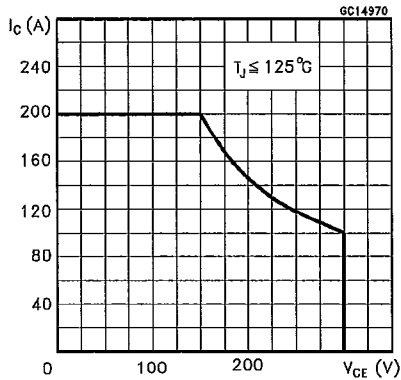

Switching Times Inductive Load

Switching Times Inductive Load Versus Temperature

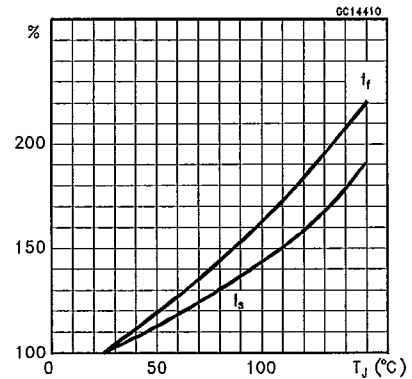
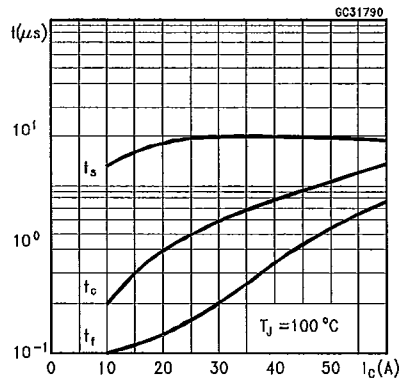

DC Current Gain

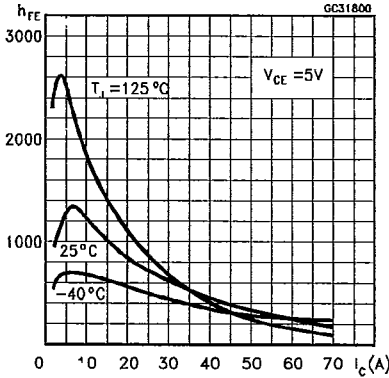

Typical V_F Versus I_F

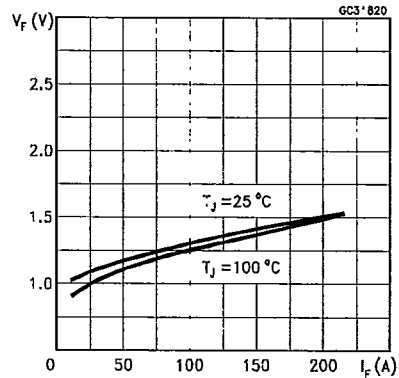

Peak Reverse Current Versus di_F/dt

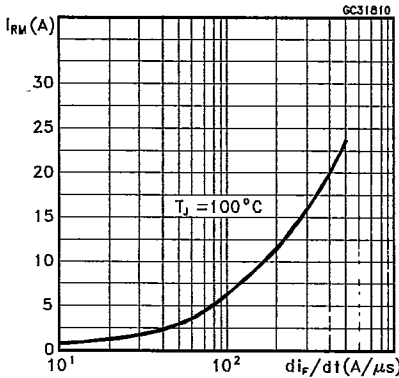

Turn-on Switching Test Circuit

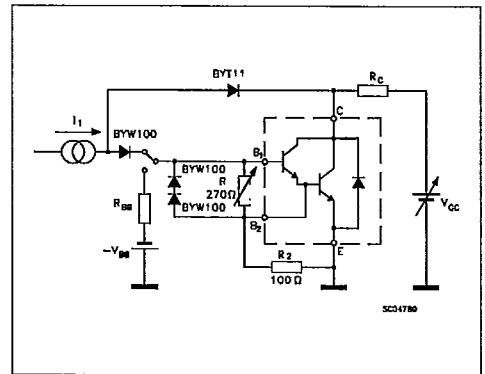

Turn-on Switching Waveforms

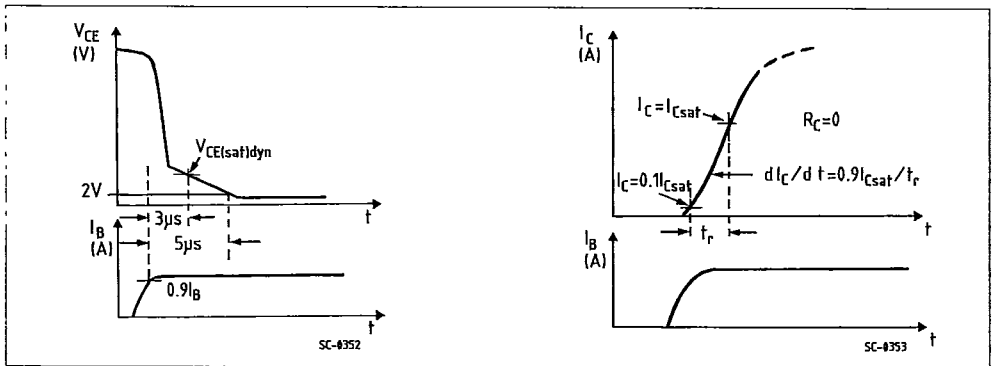

Turn-off Switching Test Circuit

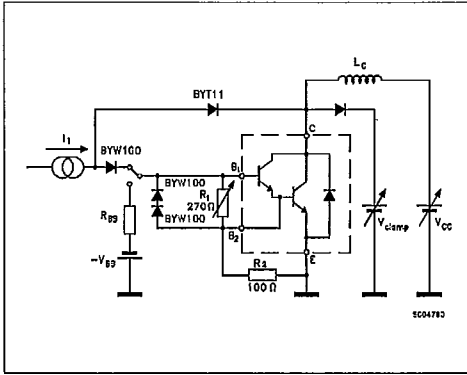

Turn-off Switching Waveforms

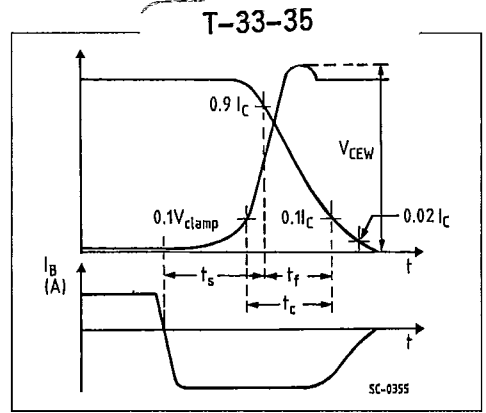

Turn-off Switching Test Circuits of Diode

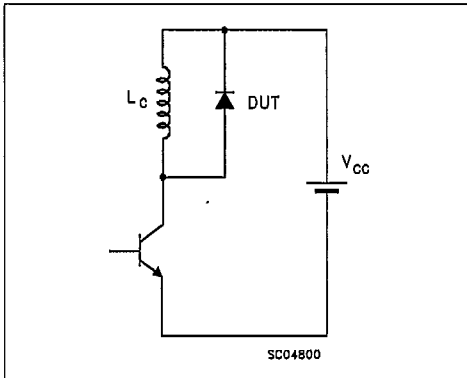

Turn-off Switching Waveform of Diode

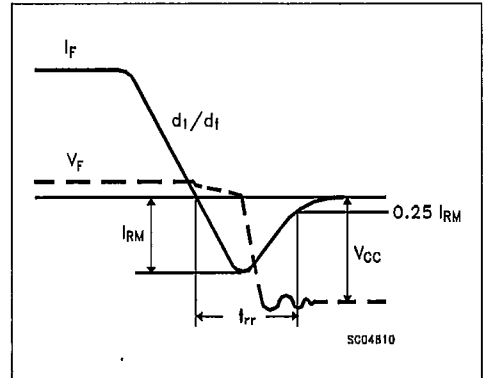

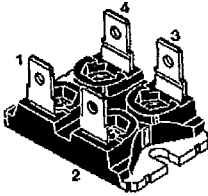

ISOTOP
Fast-on version
sales types with the suffix F

MECHANICAL DATA

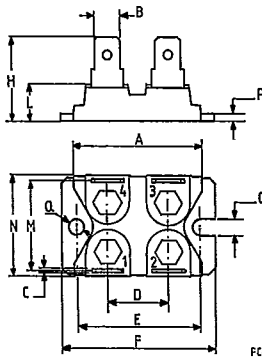

FC-9309

	DIMENSIONS			
	mm		Inches	
	min.	max	min.	max
A	31.5	31.7	1.240	1.248
B	6.2	6.4	0.244	0.252
C	0.75	0.85	0.029	0.033
D	14.9	15.1	0.586	0.590
E	30.1	30.3	1.185	1.193
F	38	38.2	1.496	1.503
G	4	-	0.157	-
H	20.3	20.7	0.799	0.815
L	8.9	9.1	0.350	0.358
M	22.4	23	0.881	0.905
N	25.2	25.4	0.992	1.000
P	1.95	2.05	0.076	0.080
Q	4	-	0.157	-

PIN CONNECTIONS

MOSFET

pin 1: Source pin 2: Gate
pin 3: Drain pin 4: Source sensings

DARLINGTON

pin 1: Emitter pin 2: Base1
pin 3: Collector pin 4: Base 2

TRANSISTOR

pin 1: Emitter pin 2: Base
pin 3: Collector pin 4: Emitter sensing

Torque: Mounting $1.3 \pm 0.2 \text{ N} \cdot \text{m}$ (max)

Weight: Package 25.5 g

Note: The mechanical data are the same for the 3 pin version (4th pin missing)

S G S-THOMSON

T-91-20

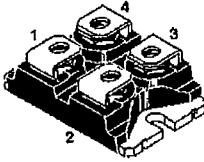

ISOTOP
Screw version
sales types with the suffix V

MECHANICAL DATA

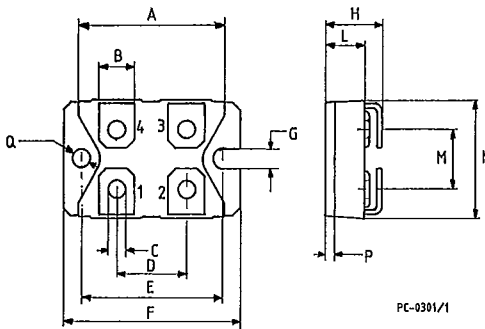

	DIMENSIONS			
	mm		Inches	
	min.	max	min.	max
A	31.5	31.7	1.240	1.248
B	7.8	8.2	0.307	0.322
C	4.1	4.3	0.161	0.169
D	14.9	15.1	0.586	0.590
E	30.1	30.3	1.185	1.193
F	38	38.2	1.496	1.503
G	4	-	0.157	-
H	11.8	12.2	0.464	0.480
L	8.9	9.1	0.350	0.358
M	12.6	12.8	0.496	0.503
N	25.2	25.4	0.992	1.000
P	1.95	2.05	0.076	0.080
Q	4	-	0.157	-

PIN CONNECTIONS

MOSFET

pin 1: Source pin 2: Gate
pin 3: Drain pin 4: Source sensings

DARLINGTON

pin 1: Emitter pin 2: Base1
pin 3: Collector pin 4: Base 2

TRANSISTOR

pin 1: Emitter pin 2: Base
pin 3: Collector pin 4: Emitter sensing

Torque: Terminal $1.3 \pm 0.2 \text{ N} \cdot \text{m}$ (max)
Mounting $1.3 \pm 0.2 \text{ N} \cdot \text{m}$ (max)

Weight: Package 29 g
4 Screws: 7.5 g

Note: The mechanical data are the same for the 3 pin version
(4th pin missing)

SGS-THOMSON

T-91-20

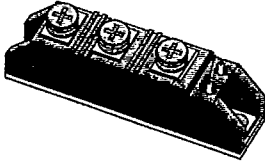

TRANSPACK (TO-240)

MECHANICAL DATA

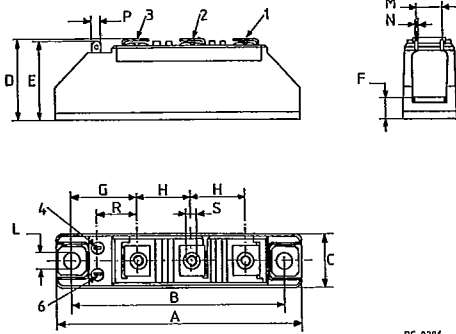

PC-0236

	DIMENSIONS			
	mm		Inches	
	min.	max	min.	max
A	91.5	92.5	3.602	3.641
B	79.75	80.25	3.140	3.160
C	19.5	20.55	0.767	0.809
D	29.00	31.00	1.141	1.220
E	28.8	30	1.134	1.181
F	8.5 typ.		0.334 typ.	
G	24.4 typ.		0.960 typ.	
H	19.5	20.5	0.767	0.807
L	6.2 typ.		0.244 typ.	
M	8.95	11.05	0.352	0.435
N	0.78	0.84	0.030	0.033
P	2.72	2.87	0.107	0.113
R	14	-	0.551	-
S	M5			

Torque: Terminal $2.2 \pm 0.5 \text{ N} \cdot \text{m}$ (max)
 Mounting $3.5 \pm 0.5 \text{ N} \cdot \text{m}$ (max)

Weight: Package 110 g
 Accessory 21 g

Note: The mechanical data are the same for the 2 power pin version (either pin 1 or pin 2 missing)