

Features

- 65V/80A,
 $R_{DS(ON)} = 7.5m$ (tpy.) @ $V_{GS} = 10V$
- Super High Dense Cell Design
- Ultra Low On-Resistance
- 100% avalanche tested
- Lead Free and Green Devices Available
 (RoHS Compliant)

Applications

- Switching Application Systems

Pin Description

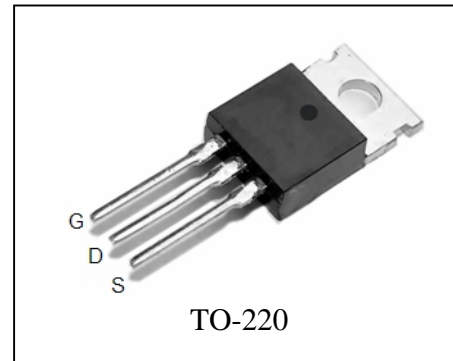

Absolute Maximum Ratings

Symbol	Parameter	Rating	Unit
Common Ratings ($T_C = 25^\circ C$ Unless Otherwise Noted)			
V_{DSS}	Drain-Source Voltage	65	V
V_{GSS}	Gate-Source Voltage	± 25	
T_J	Maximum Junction Temperature	175	$^\circ C$
T_{STG}	Storage Temperature Range	-55 to 175	$^\circ C$
I_S	Diode Continuous Forward Current	$T_C = 25^\circ C$ 80 ^①	A
Mounted on Large Heat Sink			
I_{DP}	300 μs Pulse Drain Current Tested	$T_C = 25^\circ C$ 320 ^②	A
I_D	Continuous Drain Current ($V_{GS} = 10V$)	$T_C = 25^\circ C$ 80 ^①	A
		$T_C = 100^\circ C$ 56	
P_D	Maximum Power Dissipation	$T_C = 25^\circ C$ 111	W
		$T_C = 100^\circ C$ 56	W
$R_{\theta JC}$	Thermal Resistance-Junction to Case	1.35	$^\circ C/W$
Drain-Source Avalanche Ratings			
E_{AS} ^③	Avalanche Energy, Single Pulsed	182	mJ

Electrical Characteristics ($T_C=25^\circ\text{C}$ Unless Otherwise Noted)

Symbol	Parameter	Test Condition	RU6580R			Unit
			Min.	Typ.	Max.	
Static Characteristics						
BV_{DSS}	Drain-Source Breakdown Voltage	$V_{GS}=0V, I_{DS}=250\mu A$	65			V
I_{DSS}	Zero Gate Voltage Drain Current	$V_{DS}=65V, V_{GS}=0V$ $T_J=85^\circ\text{C}$			1	μA
					30	
$V_{GS(th)}$	Gate Threshold Voltage	$V_{DS}=V_{GS}, I_{DS}=250\mu A$	2	3	4	V
I_{GSS}	Gate Leakage Current	$V_{GS}=\pm 25V, V_{DS}=0V$			± 100	nA
$R_{DS(ON)}^{(4)}$	Drain-Source On-state Resistance	$V_{GS}=10V, I_{DS}=40A$		7.5	9	m Ω
Diode Characteristics						
$V_{SD}^{(4)}$	Diode Forward Voltage	$I_{SD}=40A, V_{GS}=0V$			1.2	V
t_{rr}	Reverse Recovery Time	$I_{SD}=40A, di_{SD}/dt=100A/\mu s$		106		ns
Q_{rr}	Reverse Recovery Charge			52		nC
Dynamic Characteristics ⁽⁵⁾						
R_G	Gate Resistance	$V_{GS}=0V, V_{DS}=0V, F=1\text{MHz}$		1.8		Ω
C_{iss}	Input Capacitance	$V_{GS}=0V,$ $V_{DS}=32V,$ Frequency=1.0MHz		1800		pF
C_{oss}	Output Capacitance			380		
C_{riss}	Reverse Transfer Capacitance			140		
$t_{d(ON)}$	Turn-on Delay Time			15		
t_r	Turn-on Rise Time	$V_{DD}=32V, R_L=0.8\Omega,$ $I_{DS}=40A, V_{GEN}=10V,$ $R_G=6\Omega$		94		
$t_{d(OFF)}$	Turn-off Delay Time			46		
t_f	Turn-off Fall Time			32		
Gate Charge Characteristics ⁽⁵⁾						
Q_g	Total Gate Charge	$V_{DS}=52V, V_{GS}=10V,$ $I_{DS}=40A$		50		nC
Q_{gs}	Gate-Source Charge			12		
Q_{gd}	Gate-Drain Charge			19		

- Notes: ① Calculated continuous current based on maximum allowable junction temperature. Limited by bond wire.
 ② Pulse width limited by safe operating area.
 ③ Limited by $T_{Jmax}, I_{AS}=27A, V_{DD}=48V, R_G=50\Omega$, Starting $T_J=25^\circ\text{C}$.
 ④ Pulse test; Pulse width $\leq 300\mu s$, duty cycle $\leq 2\%$.
 ⑤ Guaranteed by design, not subject to production testing.

Typical Characteristics

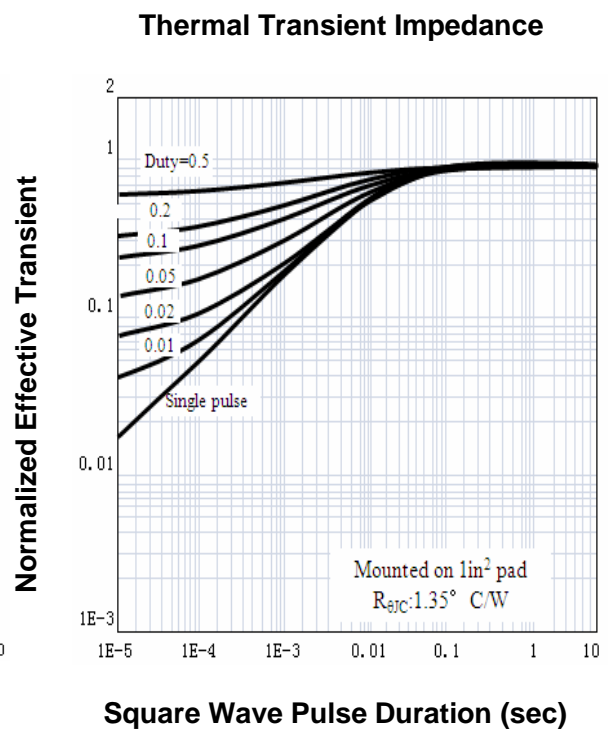
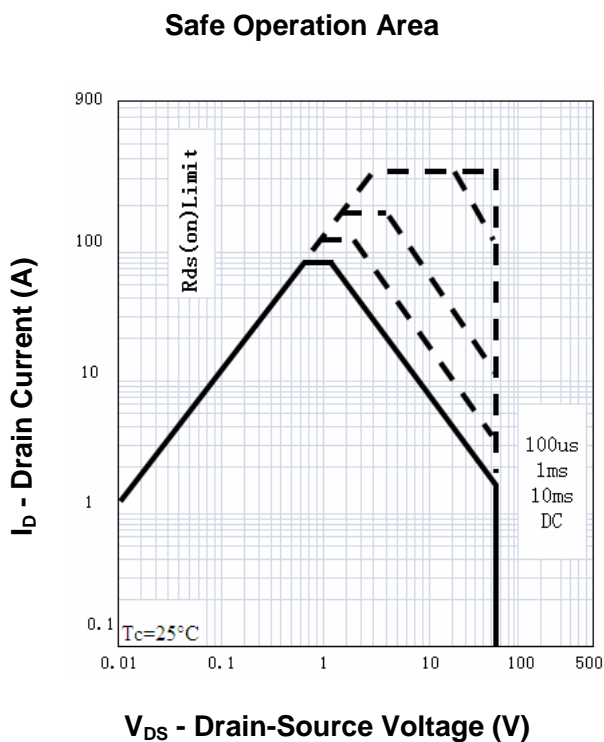
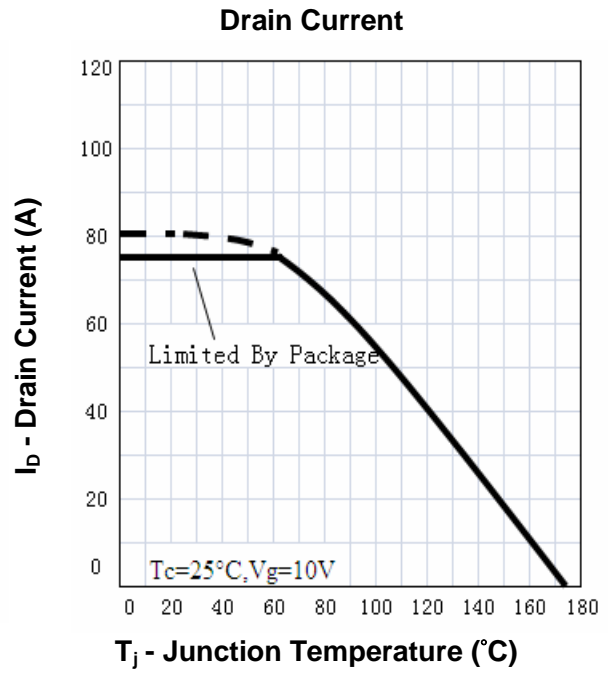
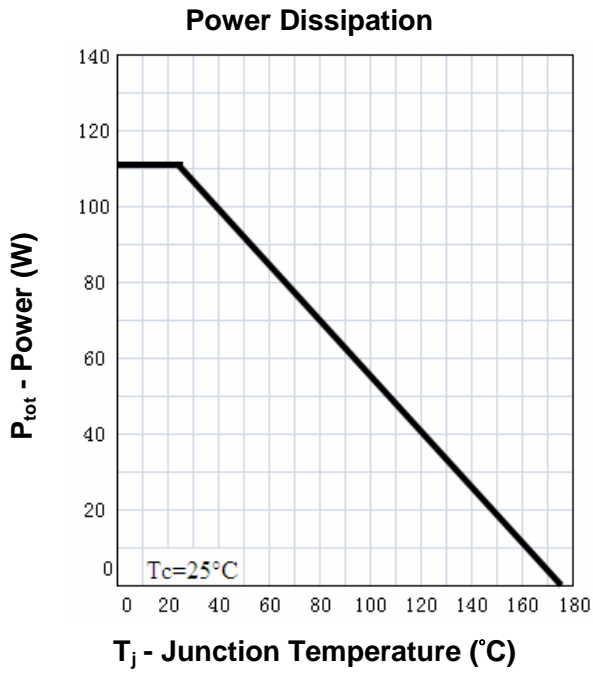

Typical Characteristics

Output Characteristics

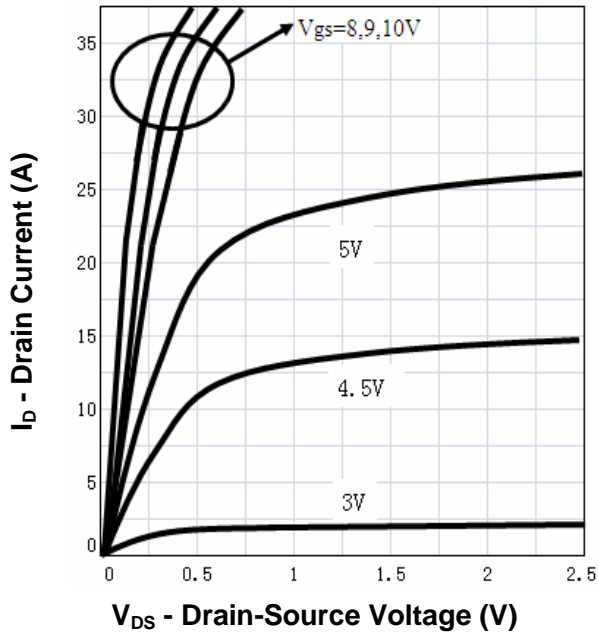

Drain-Source On Resistance

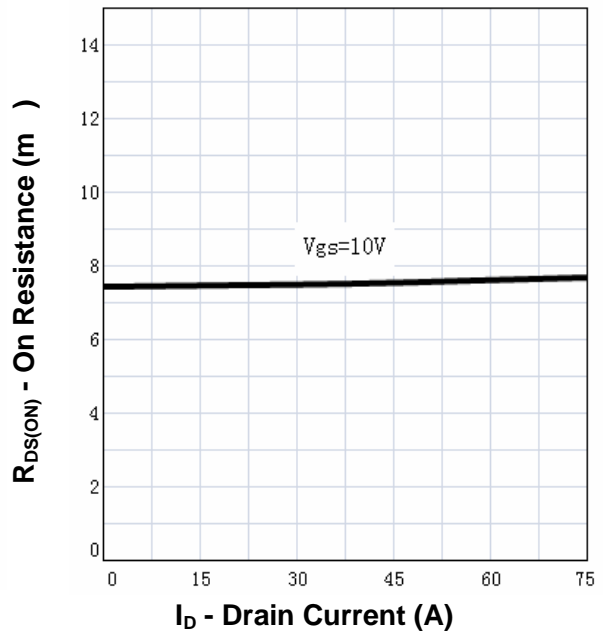

Drain-Source On Resistance

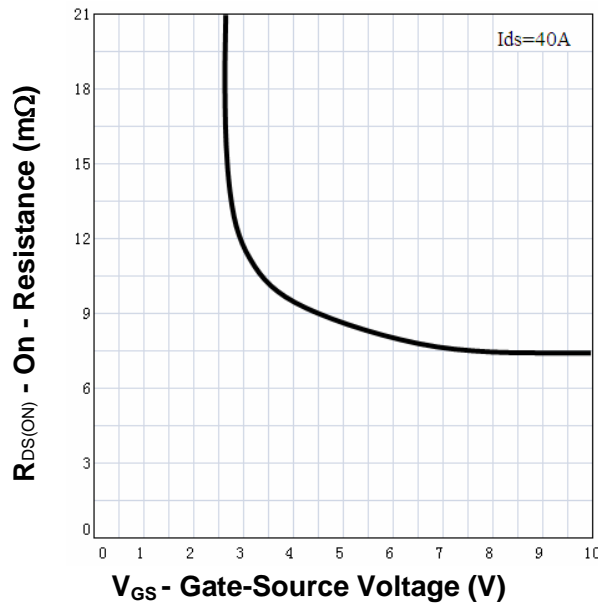

Gate Threshold Voltage

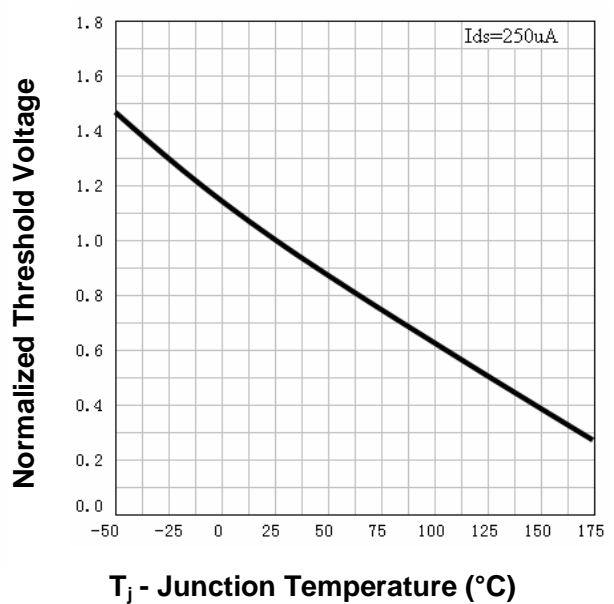

Typical Characteristics

Drain-Source On Resistance

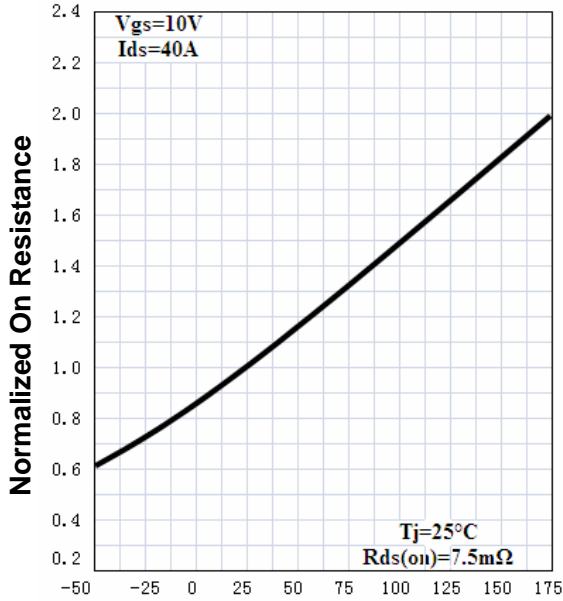

T_J - Junction Temperature (°C)

Source-Drain Diode Forward

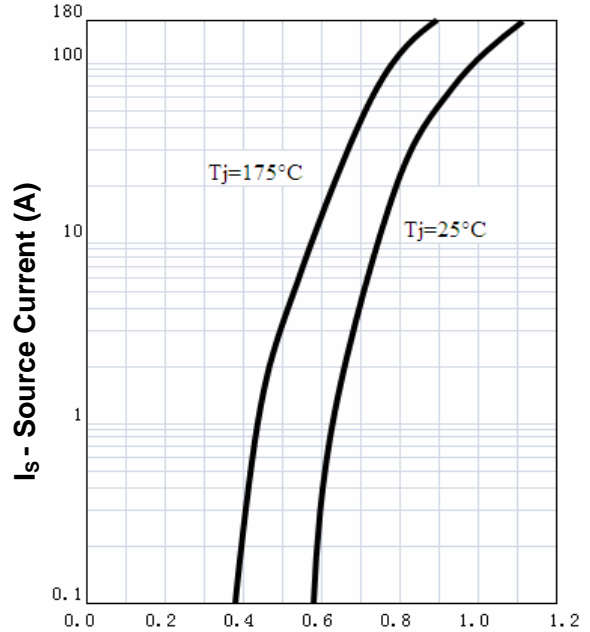

V_{SD} - Source-Drain Voltage (V)

Capacitance

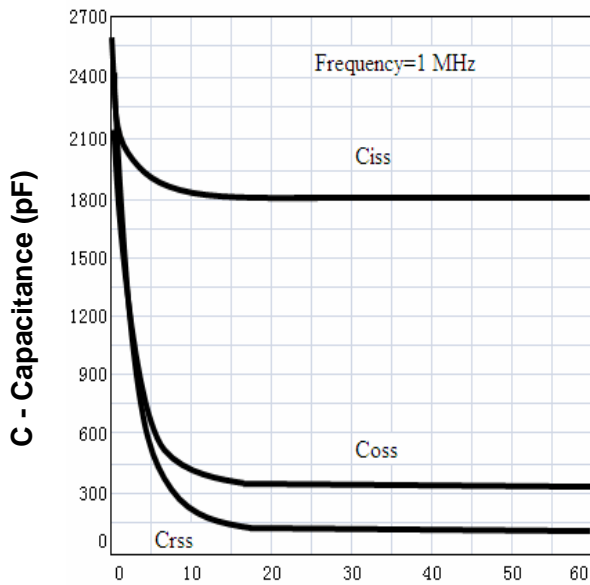

V_{DS} - Drain-Source Voltage (V)

Gate Charge

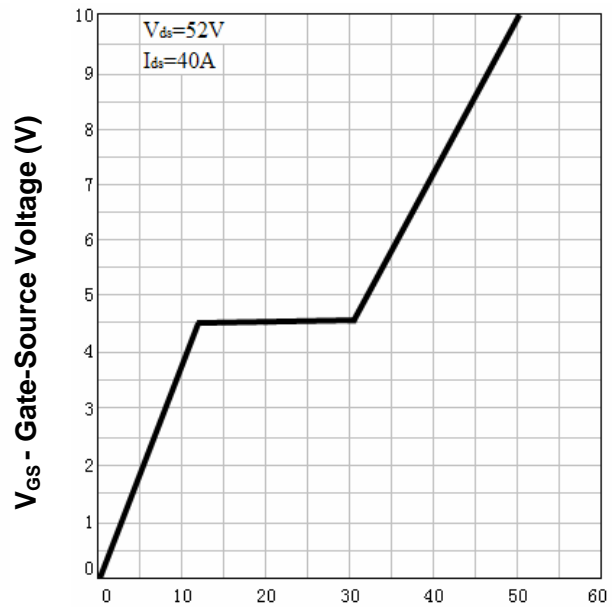

Q_G - Gate Charge (nC)

Avalanche Test Circuit and Waveforms

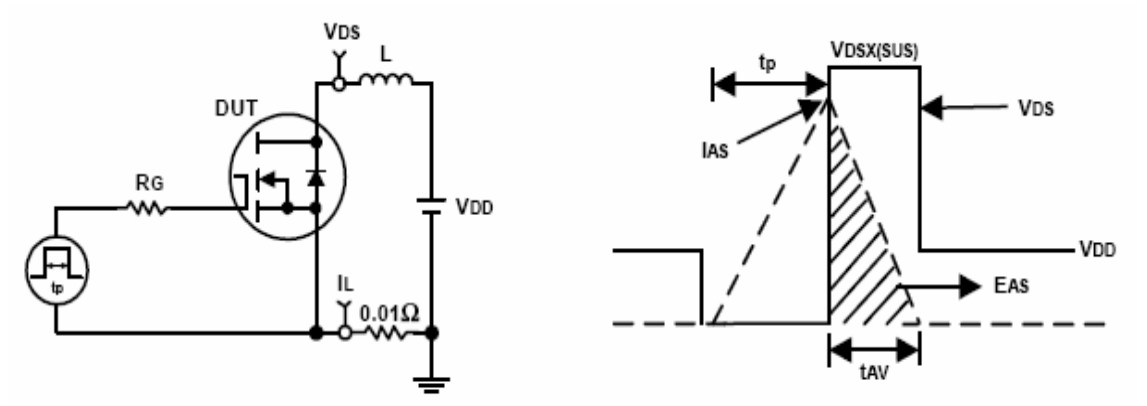

Switching Time Test Circuit and Waveforms

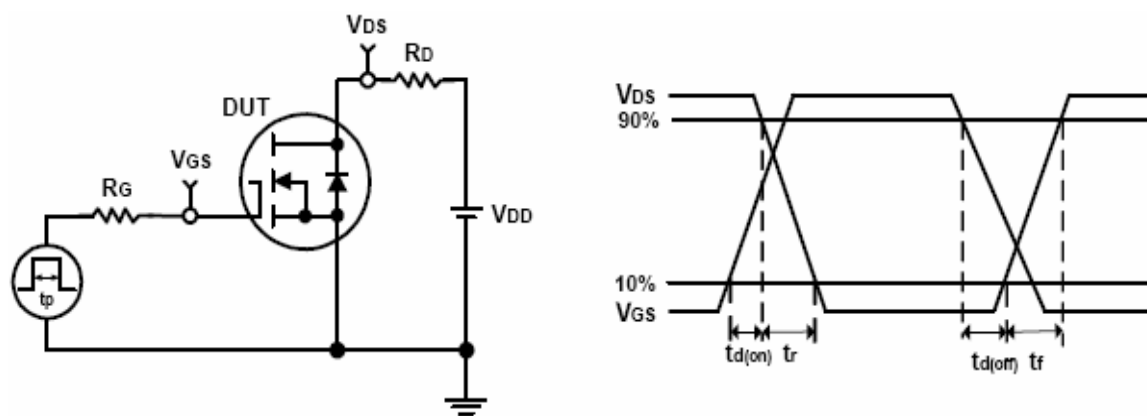

Ordering and Marking Information**RU6580****Package (Available)**

R : TO220

Operating Temperature Range

C : -55 to 175 °C

Assembly Material

G : Green & Lead Free

Packaging

T : TUBE

Package Information

TO-220FB-3L



SYMBOL	MM			INCH			SYMBOL	MM			INCH		
	MIN	NOM	MAX	MIN	NOM	MAX		MIN	NOM	MAX	MIN	NOM	MAX
A	4.40	4.57	4.70	0.173	0.180	0.185	$\phi p1$	1.40	1.50	1.60	0.055	0.059	0.063
A1	1.27	1.30	1.33	0.050	0.051	0.052	e	2.54BSC			0.1BSC		
A2	2.35	2.40	2.50	0.093	0.094	0.098	e1	5.08BSC			0.2BSC		
b	0.77	-	0.90	0.030	-	0.035	H1	6.40	6.50	6.60	0.252	0.256	0.260
b2	1.23	-	1.36	0.048	-	0.054	L	12.75	-	13.17	0.502	-	0.519
C	0.48	0.50	0.52	0.019	0.020	0.021	L1	-	-	3.95	-	-	0.156
D	15.40	15.60	15.80	0.606	0.614	0.622	L2	2.50REF.			0.098REF.		
D1	9.00	9.10	9.20	0.354	0.358	0.362	ϕp	3.57	3.60	3.63	0.141	0.142	0.143
DEP	0.05	0.10	0.20	0.002	0.004	0.008	Q	2.73	2.80	2.87	0.107	0.110	0.113
E	9.70	9.90	10.10	0.382	0.389	0.398	$\theta 1$	5°	7°	9°	5°	7°	9°
E1	-	8.70	-	-	0.343	-	$\theta 2$	1°	3°	5°	1°	3°	5°
E2	9.80	10.00	10.20	0.386	0.394	0.401							

ALL DIMENSIONS REFER TO JEDEC STANDARD
DO NOT INCLUDE MOLD FLASH OR PROTRUSIONS

Customer Service

Worldwide Sales and Service:

Sales@ruichips.com

Technical Support:

Technical@ruichips.com

Investor Relations Contacts:

Investor@ruichips.com

Marcom Contact:

Marcom@ruichips.com

Editorial Contact:

Editorial@ruichips.com

HR Contact:

HR@ruichips.com

Legal Contact:

Legal@ruichips.com

Shen Zhen RUICHIPS Semiconductor CO., LTD

Room 501, the 5floor An Tong Industrial Building,
NO.207 Mei Hua Road Fu Tian Area Shen Zhen City, CHINA

TEL: (86-755) 8311-5334

FAX: (86-755) 8311-4278

E-mail: Sales-SZ@ruichips.com