

Intel[®] 4 Series Chipset Family

Datasheet

For the Intel[®] 82Q45, 82Q43, 82B43, 82G45, 82G43, 82G41 Graphics and Memory Controller Hub (GMCH) and the Intel[®] 82P45, 82P43 Memory Controller Hub (MCH)

March 2010

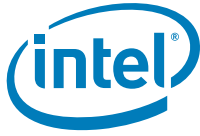

INFORMATION IN THIS DOCUMENT IS PROVIDED IN CONNECTION WITH INTEL® PRODUCTS. NO LICENSE, EXPRESS OR IMPLIED, BY ESTOPPEL OR OTHERWISE, TO ANY INTELLECTUAL PROPERTY RIGHTS IS GRANTED BY THIS DOCUMENT. EXCEPT AS PROVIDED IN INTEL'S TERMS AND CONDITIONS OF SALE FOR SUCH PRODUCTS, INTEL ASSUMES NO LIABILITY WHATSOEVER, AND INTEL DISCLAIMS ANY EXPRESS OR IMPLIED WARRANTY, RELATING TO SALE AND/OR USE OF INTEL PRODUCTS INCLUDING LIABILITY OR WARRANTIES RELATING TO FITNESS FOR A PARTICULAR PURPOSE, MERCHANTABILITY, OR INFRINGEMENT OF ANY PATENT, COPYRIGHT OR OTHER INTELLECTUAL PROPERTY RIGHT. Intel products are not intended for use in medical, life saving, life sustaining, critical control or safety systems, or in nuclear facility applications.

Intel may make changes to specifications and product descriptions at any time, without notice.

Designers must not rely on the absence or characteristics of any features or instructions marked "reserved" or "undefined." Intel reserves these for future definition and shall have no responsibility whatsoever for conflicts or incompatibilities arising from future changes to them.

The Intel® 4 Series Chipset family may contain design defects or errors known as errata, which may cause the product to deviate from published specifications. Current characterized errata are available on request.

Contact your local Intel sales office or your distributor to obtain the latest specifications and before placing your product order.

I²C is a two-wire communications bus/protocol developed by Philips. SMBus is a subset of the I²C bus/protocol and was developed by Intel. Implementations of the I²C bus/protocol may require licenses from various entities, including Philips Electronics N.V. and North American Philips Corporation.

Intel® Active Management Technology requires the platform to have an Intel® AMT-enabled chipset, network hardware and software, connection with a power source and a network connection.

No computer system can provide absolute security under all conditions. Intel® Trusted Execution Technology (Intel® TXT) is a security technology under development by Intel and requires for operation a computer system with Intel® Virtualization Technology, a Intel® Trusted Execution Technology-enabled Intel processor, chipset, BIOS, Authenticated Code Modules, and an Intel or other Intel® Trusted Execution Technology compatible measured virtual machine monitor. In addition, Intel® Trusted Execution Technology requires the system to contain a TPMv1.2 as defined by the Trusted Computing Group and specific software for some uses.

Intel® Virtualization Technology requires a computer system with an enabled Intel® processor, BIOS, virtual machine monitor (VMM) and, for some uses, certain computer system software enabled for it. Functionality, performance or other benefits will vary depending on hardware and software configurations and may require a BIOS update. Software applications may not be compatible with all operating systems. Please check with your application vendor.

Intel, Pentium, Intel Core, and the Intel logo are trademarks of Intel Corporation in the U.S. and other countries.

*Other names and brands may be claimed as the property of others.

Copyright © 2010, Intel Corporation

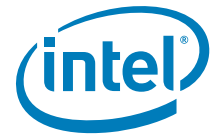

Contents

| | | |
|----------|-----------------------------------------------------------------------------------------------|----|
| 1 | Introduction | 21 |
| 1.1 | Terminology | 27 |
| 1.2 | (G)MCH System Overview | 30 |
| 1.2.1 | Host Interface | 30 |
| 1.2.2 | System Memory Interface | 31 |
| 1.2.3 | Direct Media Interface (DMI) | 31 |
| 1.2.4 | Multiplexed PCI Express* Graphics Interface and Intel® sDVO/DVI/HDMI/DP Interface | 32 |
| 1.2.4.1 | PCI Express* Interface | 32 |
| 1.2.4.2 | sDVO Multiplexed Interface (Intel® 82Q45, 82Q43, 82B43, 82G45, 82G43, 82G41 GMCH Only) | 33 |
| 1.2.4.3 | HDMI/DVI/DP Multiplexed Interface (Intel® 82Q45, 82Q43, 82B43, 82G45, 82G43, 82G41 GMCH Only) | 33 |
| 1.2.5 | Graphics Features (Intel® 82Q45, 82Q43, 82B43, 82G45, 82G43, 82G41 GMCH Only) | 33 |
| 1.2.6 | (G)MCH Clocking | 33 |
| 1.2.7 | Power Management | 34 |
| 1.2.8 | Thermal Sensor | 34 |
| 2 | Signal Description | 35 |
| 2.1 | Host Interface Signals | 36 |
| 2.2 | System Memory (DDR2/DDR3) Interface Signals | 39 |
| 2.2.1 | System Memory Channel A Interface Signals | 39 |
| 2.2.2 | System Memory Channel B Interface Signals | 40 |
| 2.2.3 | System Memory Miscellaneous Signals | 41 |
| 2.3 | PCI Express* Interface Signals | 41 |
| 2.4 | Controller Link Interface Signals | 42 |
| 2.5 | Analog Display Signals (Intel® 82Q45, 82Q43, 82B43, 82G45, 82G43, 82G41 GMCH Only) | 42 |
| 2.6 | Clocks, Reset, and Miscellaneous | 43 |
| 2.7 | Direct Media Interface | 44 |
| 2.8 | Serial DVO Interface (Intel® 82Q45, 82Q43, 82B43, 82G45, 82G43, 82G41 GMCH Only) | 45 |
| 2.9 | HDMI Interface (Intel® 82G45, 82G43, 82G41, 82B43 GMCH Only) | 48 |
| 2.10 | Display Port Interface (Intel® 82Q45, 82Q43, 82B43, 82G45, 82G43, 82G41 GMCH Only) | 49 |
| 2.11 | Intel® High Definition Audio Intel® 82Q45, 82Q43, 82B43, 82G45, 82G43, 82G41 GMCH Only) | 50 |
| 2.12 | Power and Grounds | 51 |
| 3 | System Address Map | 53 |
| 3.1 | Legacy Address Range | 57 |
| 3.1.1 | DOS Range (0h – 9_FFFFh) | 57 |
| 3.1.2 | Legacy Video Area (A_0000h–B_FFFFh) | 57 |
| 3.1.3 | Expansion Area (C_0000h–D_FFFFh) | 59 |
| 3.1.4 | Extended System BIOS Area (E_0000h–E_FFFFh) | 59 |
| 3.1.5 | System BIOS Area (F_0000h–F_FFFFh) | 60 |
| 3.1.6 | PAM Memory Area Details | 60 |
| 3.2 | Main Memory Address Range (1MB – TOLUD) | 60 |
| 3.2.1 | ISA Hole (15 MB –16 MB) | 61 |
| 3.2.2 | TSEG | 62 |
| 3.2.3 | Pre-allocated Memory | 62 |

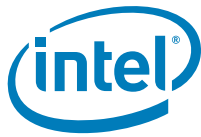

| | | |
|----------|--------------------------------------------------------------------------------------------------|-----------|
| 3.3 | PCI Memory Address Range (TOLUD – 4 GB) | 63 |
| 3.3.1 | APIC Configuration Space (FEC0_0000h–FECF_FFFFh) | 65 |
| 3.3.2 | HSEG (FEDA_0000h–FEDB_FFFFh) | 65 |
| 3.3.3 | FSB Interrupt Memory Space (FEE0_0000–FEEF_FFFF) | 65 |
| 3.3.4 | High BIOS Area | 65 |
| 3.4 | Main Memory Address Space (4 GB to TOUUD) | 66 |
| 3.4.1 | Memory Re-claim Background | 67 |
| 3.4.2 | Memory Reclaiming | 67 |
| 3.5 | PCI Express* Configuration Address Space | 67 |
| 3.6 | PCI Express* Address Space | 68 |
| 3.7 | Graphics Memory Address Ranges (Intel® 82Q45, 82Q43, 82B43, 82G45, 82G43, 82G41 GMCH Only) | 69 |
| 3.8 | System Management Mode (SMM) | 69 |
| 3.8.1 | SMM Space Definition | 69 |
| 3.8.2 | SMM Space Restrictions | 70 |
| 3.8.3 | SMM Space Combinations | 70 |
| 3.8.4 | SMM Control Combinations | 70 |
| 3.8.5 | SMM Space Decode and Transaction Handling | 71 |
| 3.8.6 | Processor WB Transaction to an Enabled SMM Address Space | 71 |
| 3.8.7 | SMM Access Through GTT TLB (Intel® 82Q45, 82Q43, 82B43, 82G45, 82G43, 82G41 GMCH Only) | 71 |
| 3.9 | Memory Shadowing | 72 |
| 3.10 | I/O Address Space | 72 |
| 3.10.1 | PCI Express* I/O Address Mapping | 73 |
| 3.11 | (G)MCH Decode Rules and Cross-Bridge Address Mapping | 73 |
| 3.11.1 | Legacy VGA and I/O Range Decode Rules | 73 |
| 4 | Register Description | 75 |
| 4.1 | Register Terminology | 76 |
| 4.2 | Configuration Process and Registers | 77 |
| 4.2.1 | Platform Configuration Structure | 77 |
| 4.3 | Configuration Mechanisms | 78 |
| 4.3.1 | Standard PCI Configuration Mechanism | 78 |
| 4.3.2 | PCI Express* Enhanced Configuration Mechanism | 78 |
| 4.4 | Routing Configuration Accesses | 80 |
| 4.4.1 | Internal Device Configuration Accesses | 81 |
| 4.4.2 | Bridge Related Configuration Accesses | 81 |
| 4.4.2.1 | PCI Express* Configuration Accesses | 81 |
| 4.4.2.2 | DMI Configuration Accesses | 82 |
| 4.5 | I/O Mapped Registers | 82 |
| 4.5.1 | CONFIG_ADDRESS—Configuration Address Register | 82 |
| 4.5.2 | CONFIG_DATA—Configuration Data Register | 84 |
| 5 | DRAM Controller Registers (D0:F0) | 85 |
| 5.1 | DRAM Controller Registers (D0:F0) | 85 |
| 5.1.1 | VID—Vendor Identification | 87 |
| 5.1.2 | DID—Device Identification | 87 |
| 5.1.3 | PCICMD—PCI Command | 88 |
| 5.1.4 | PCISTS—PCI Status | 89 |
| 5.1.5 | RID—Revision Identification | 90 |
| 5.1.6 | CC—Class Code | 91 |
| 5.1.7 | MLT—Master Latency Timer | 91 |
| 5.1.8 | HDR—Header Type | 92 |
| 5.1.9 | SVID—Subsystem Vendor Identification | 92 |
| 5.1.10 | SID—Subsystem Identification | 92 |
| 5.1.11 | CAPPTR—Capabilities Pointer | 93 |

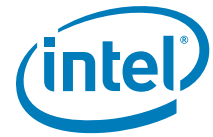

| | | |
|--------|----------------------------------------------------------------------------------------------------------|-----|
| 5.1.12 | PXPEPBAR—PCI Express Egress Port Base Address..... | 93 |
| 5.1.13 | MCHBAR—(G)MCH Memory Mapped Register Range Base | 94 |
| 5.1.14 | GGC—GMCH Graphics Control Register (Intel® 82Q45, 82Q43, 82B43, 82G45, 82G43, 82G41 GMCH Only) | 95 |
| 5.1.15 | DEVEN—Device Enable..... | 97 |
| 5.1.16 | PCIEXBAR—PCI Express Register Range Base Address..... | 99 |
| 5.1.17 | DMIBAR—Root Complex Register Range Base Address..... | 101 |
| 5.1.18 | PAM0—Programmable Attribute Map 0 | 102 |
| 5.1.19 | PAM1—Programmable Attribute Map 1 | 103 |
| 5.1.20 | PAM2—Programmable Attribute Map 2 | 104 |
| 5.1.21 | PAM3—Programmable Attribute Map 3 | 105 |
| 5.1.22 | PAM4—Programmable Attribute Map 4 | 106 |
| 5.1.23 | PAM5—Programmable Attribute Map 5 | 107 |
| 5.1.24 | PAM6—Programmable Attribute Map 6 | 108 |
| 5.1.25 | LAC—Legacy Access Control | 109 |
| 5.1.26 | REMAPBASE—Remap Base Address Register | 111 |
| 5.1.27 | REMAPLIMIT—Remap Limit Address Register..... | 111 |
| 5.1.28 | SMRAM—System Management RAM Control | 112 |
| 5.1.29 | ESMRAMC—Extended System Management RAM Control..... | 113 |
| 5.1.30 | TOM—Top of Memory..... | 114 |
| 5.1.31 | TOUUD—Top of Upper Usable DRAM | 115 |
| 5.1.32 | GBSM—Graphics Base of Stolen Memory (Intel® 82Q45, 82Q43, 82B43, 82G45, 82G43, 82G41 GMCH Only) | 116 |
| 5.1.33 | BGSM—Base of GTT stolen Memory (Intel® 82Q45, 82Q43, 82B43, 82G45, 82G43, 82G41 GMCH Only) | 116 |
| 5.1.34 | TSEGMB—TSEG Memory Base..... | 117 |
| 5.1.35 | TOLUD—Top of Low Usable DRAM..... | 117 |
| 5.1.36 | ERRSTS—Error Status..... | 118 |
| 5.1.37 | ERRCMD—Error Command..... | 120 |
| 5.1.38 | SMICMD—SMI Command..... | 121 |
| 5.1.39 | SKPD—Scratchpad Data | 122 |
| 5.1.40 | CAPID0—Capability Identifier | 122 |
| 5.2 | MCHBAR | 123 |
| 5.2.1 | CHDECMISC—Channel Decode Miscellaneous | 125 |
| 5.2.2 | C0DRB0—Channel 0 DRAM Rank Boundary Address 0 | 126 |
| 5.2.3 | C0DRB1—Channel 0 DRAM Rank Boundary Address 1 | 128 |
| 5.2.4 | C0DRB2—Channel 0 DRAM Rank Boundary Address 2 | 128 |
| 5.2.5 | C0DRB3—Channel 0 DRAM Rank Boundary Address 3 | 129 |
| 5.2.6 | C0DRA01—Channel 0 DRAM Rank 0,1 Attribute | 130 |
| 5.2.7 | C0DRA23—Channel 0 DRAM Rank 2,3 Attribute | 131 |
| 5.2.8 | C0CYCTRPCHG—Channel 0 CYCTRK PCHG | 131 |
| 5.2.9 | C0CYCTRKACT—Channel 0 CYCTRK ACT | 132 |
| 5.2.10 | C0CYCTRKWR—Channel 0 CYCTRK WR..... | 133 |
| 5.2.11 | C0CYCTRKRD—Channel 0 CYCTRK READ | 134 |
| 5.2.12 | C0CYCTRKREFR—Channel 0 CYCTRK REFR..... | 135 |
| 5.2.13 | C0CKECTRL—Channel 0 CKE Control | 135 |
| 5.2.14 | C0REFRCTRL—Channel 0 DRAM Refresh Control | 137 |
| 5.2.15 | C0ODTCTRL—Channel 0 ODT Control | 139 |
| 5.2.16 | C1DRB1—Channel 1 DRAM Rank Boundary Address 1 | 139 |
| 5.2.17 | C1DRB2—Channel 1 DRAM Rank Boundary Address 2 | 140 |
| 5.2.18 | C1DRB3—Channel 1 DRAM Rank Boundary Address 3 | 140 |
| 5.2.19 | C1DRA01—Channel 1 DRAM Rank 0,1 Attributes..... | 141 |
| 5.2.20 | C1DRA23—Channel 1 DRAM Rank 2,3 Attributes..... | 141 |
| 5.2.21 | C1CYCTRPCHG—Channel 1 CYCTRK PCHG | 142 |
| 5.2.22 | C1CYCTRKACT—Channel 1 CYCTRK ACT | 143 |

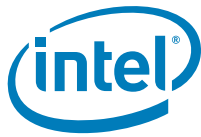

| | | |
|----------|--------------------------------------------------------------|------------|
| 5.2.23 | C1CYCTRKWR—Channel 1 CYCTRK WR | 144 |
| 5.2.24 | C1CYCTRKRD—Channel 1 CYCTRK READ | 145 |
| 5.2.25 | C1CKECTRL—Channel 1 CKE Control | 145 |
| 5.2.26 | C1REFRCTRL—Channel 1 DRAM Refresh Control | 147 |
| 5.2.27 | C1ODTCTRL—Channel 1 ODT Control..... | 149 |
| 5.2.28 | EPCODRB0—EP Channel 0 DRAM Rank Boundary Address 0 | 149 |
| 5.2.29 | EPCODRB1—EP Channel 0 DRAM Rank Boundary Address 1 | 150 |
| 5.2.30 | EPCODRB2—EP Channel 0 DRAM Rank Boundary Address 2 | 150 |
| 5.2.31 | EPCODRB3—EP Channel 0 DRAM Rank Boundary Address 3 | 150 |
| 5.2.32 | EPCODRA01—EP Channel 0 DRAM Rank 0,1 Attribute..... | 151 |
| 5.2.33 | EPCODRA23—EP Channel 0 DRAM Rank 2,3 Attribute..... | 151 |
| 5.2.34 | EPDCYCTRKWRTPRE—EPD CYCTRK WRT PRE | 152 |
| 5.2.35 | EPDCYCTRKWRTACT—EPD CYCTRK WRT ACT | 152 |
| 5.2.36 | EPDCYCTRKWRTWR—EPD CYCTRK WRT WR | 153 |
| 5.2.37 | EPDCYCTRKWRTREF—EPD CYCTRK WRT REF | 153 |
| 5.2.38 | EPDCYCTRKWRTRD—EPD CYCTRK WRT READ | 154 |
| 5.2.39 | EPDCKECONFIGREG—EPD CKE Related Configuration Registers..... | 155 |
| 5.2.40 | EPDREFCONFIG—EP DRAM Refresh Configuration | 156 |
| 5.2.41 | TSC1—Thermal Sensor Control 1 | 158 |
| 5.2.42 | TSC2—Thermal Sensor Control 2 | 159 |
| 5.2.43 | TSS—Thermal Sensor Status | 161 |
| 5.2.44 | TSTTP—Thermal Sensor Temperature Trip Point | 162 |
| 5.2.45 | TCO—Thermal Calibration Offset | 163 |
| 5.2.46 | THERM1—Hardware Throttle Control | 164 |
| 5.2.47 | TIS—Thermal Interrupt Status..... | 165 |
| 5.2.48 | TSMICMD—Thermal SMI Command | 167 |
| 5.2.49 | PMSTS—Power Management Status..... | 168 |
| 5.3 | EPBAR..... | 169 |
| 5.3.1 | EPESD—EP Element Self Description..... | 169 |
| 5.3.2 | EPLE1D—EP Link Entry 1 Description | 170 |
| 5.3.3 | EPLE1A—EP Link Entry 1 Address | 170 |
| 5.3.4 | EPLE2D—EP Link Entry 2 Description | 171 |
| 5.3.5 | EPLE2A—EP Link Entry 2 Address..... | 172 |
| 6 | Host-PCI Express* Registers (D1:F0)..... | 173 |
| 6.1 | Host-PCI Express* Register Description (D1:F0) | 175 |
| 6.1.1 | VID1—Vendor Identification | 175 |
| 6.1.2 | DID1—Device Identification..... | 175 |
| 6.1.3 | PCICMD1—PCI Command | 176 |
| 6.1.4 | PCISTS1—PCI Status..... | 178 |
| 6.1.5 | RID1—Revision Identification | 179 |
| 6.1.6 | CC1—Class Code | 180 |
| 6.1.7 | CL1—Cache Line Size | 180 |
| 6.1.8 | HDR1—Header Type..... | 181 |
| 6.1.9 | PBUSN1—Primary Bus Number | 181 |
| 6.1.10 | SBUSN1—Secondary Bus Number | 181 |
| 6.1.11 | SUBUSN1—Subordinate Bus Number | 182 |
| 6.1.12 | IOBASE1—I/O Base Address | 182 |
| 6.1.13 | IOLIMIT1—I/O Limit Address..... | 183 |
| 6.1.14 | SSTS1—Secondary Status..... | 183 |
| 6.1.15 | MBASE1—Memory Base Address | 184 |
| 6.1.16 | MLIMIT1—Memory Limit Address | 185 |
| 6.1.17 | PMBASE1—Prefetchable Memory Base Address | 186 |
| 6.1.18 | PMLIMIT1—Prefetchable Memory Limit Address..... | 187 |
| 6.1.19 | PMBASEU1—Prefetchable Memory Base Address Upper | 188 |



| | | |
|----------|-------------------------------------------------------------------------------------|------------|
| 6.1.20 | PMLIMITU1—Prefetchable Memory Limit Address Upper | 189 |
| 6.1.21 | CAPPTR1—Capabilities Pointer | 189 |
| 6.1.22 | INTRLINE1—Interrupt Line | 190 |
| 6.1.23 | INTRPIN1—Interrupt Pin | 190 |
| 6.1.24 | BCTRL1—Bridge Control | 191 |
| 6.1.25 | PM_CAPID1—Power Management Capabilities | 193 |
| 6.1.26 | PM_CS1—Power Management Control/Status | 194 |
| 6.1.27 | SS_CAPID—Subsystem ID and Vendor ID Capabilities | 195 |
| 6.1.28 | SS—Subsystem ID and Subsystem Vendor ID | 196 |
| 6.1.29 | MSI_CAPID—Message Signaled Interrupts Capability ID | 196 |
| 6.1.30 | MC—Message Control | 197 |
| 6.1.31 | MA—Message Address | 198 |
| 6.1.32 | MD—Message Data | 198 |
| 6.1.33 | PEG_CAPL—PCI Express-G Capability List | 198 |
| 6.1.34 | PEG_CAP—PCI Express-G Capabilities | 199 |
| 6.1.35 | DCAP—Device Capabilities | 199 |
| 6.1.36 | DCTL—Device Control | 200 |
| 6.1.37 | DSTS—Device Status | 201 |
| 6.1.38 | LCAP—Link Capabilities | 202 |
| 6.1.39 | LCTL—Link Control | 204 |
| 6.1.40 | LSTS—Link Status | 206 |
| 6.1.41 | SLOTCAP—Slot Capabilities | 208 |
| 6.1.42 | SLOTCTL—Slot Control | 209 |
| 6.1.43 | SLOTSTS—Slot Status | 210 |
| 6.1.44 | RCTL—Root Control | 211 |
| 6.1.45 | RSTS—Root Status | 212 |
| 6.1.46 | DCAP2—Device Capabilities 2 | 212 |
| 6.1.47 | DCTL2—Device Control 2 | 212 |
| 6.1.48 | DSTS2—Device Status 2 | 213 |
| 6.1.49 | LCAP2—Link Capabilities 2 | 213 |
| 6.1.50 | LCTL2—Link Control 2 | 214 |
| 6.1.51 | LSTS2—Link Status 2 | 216 |
| 6.1.52 | SCAP2—Slot Capabilities 2 | 217 |
| 6.1.53 | SCTL2—Slot Control 2 | 217 |
| 6.1.54 | SSTS2—Slot Status 2 | 217 |
| 6.1.55 | PEGLC—PCI Express-G Legacy Control | 218 |
| 7 | Direct Memory Interface Registers (DMIBAR) | 219 |
| 7.1 | DMIVCECH—DMI Virtual Channel Enhanced Capability | 220 |
| 7.2 | DMIPVCCAP1—DMI Port VC Capability Register 1 | 220 |
| 7.3 | DMIPVCCAP2—DMI Port VC Capability Register 2 | 221 |
| 7.4 | DMIPVCCTL—DMI Port VC Control | 221 |
| 7.5 | DMIVCORCAP—DMI VC0 Resource Capability | 222 |
| 7.6 | DMIVCORCTL0—DMI VC0 Resource Control | 222 |
| 7.7 | DMIVCORSTS—DMI VC0 Resource Status | 223 |
| 7.8 | DMIVC1RCAP—DMI VC1 Resource Capability | 224 |
| 7.9 | DMIVC1RCTL1—DMI VC1 Resource Control | 224 |
| 7.10 | DMIVC1RSTS—DMI VC1 Resource Status | 226 |
| 7.11 | DMILCAP—DMI Link Capabilities | 227 |
| 7.12 | DMILCTL—DMI Link Control | 228 |
| 7.13 | DMILSTS—DMI Link Status | 228 |
| 8 | Host-Secondary PCI Express* Bridge Registers (D6:F0) (Intel® 82P45 MCH Only) | 229 |
| 8.1 | VID1—Vendor Identification | 231 |
| 8.2 | DID1—Device Identification | 232 |
| 8.3 | PCICMD1—PCI Command | 232 |



| | | |
|------|-----------------------------------------------------------|-----|
| 8.4 | PCISTS1—PCI Status..... | 234 |
| 8.5 | RID1—Revision Identification | 235 |
| 8.6 | CC1—Class Code | 235 |
| 8.7 | CL1—Cache Line Size | 236 |
| 8.8 | HDR1—Header Type..... | 236 |
| 8.9 | PBUSN1—Primary Bus Number | 236 |
| 8.10 | SBUSN1—Secondary Bus Number | 237 |
| 8.11 | SUBUSN1—Subordinate Bus Number..... | 237 |
| 8.12 | IOBASE1—I/O Base Address | 238 |
| 8.13 | IOLIMIT1—I/O Limit Address..... | 238 |
| 8.14 | SSTS1—Secondary Status..... | 239 |
| 8.15 | MBASE1—Memory Base Address | 240 |
| 8.16 | MLIMIT1—Memory Limit Address | 241 |
| 8.17 | PMBASE1—Prefetchable Memory Base Address Upper | 242 |
| 8.18 | PMLIMIT1—Prefetchable Memory Limit Address..... | 243 |
| 8.19 | PMBASEU1—Prefetchable Memory Base Address Upper | 244 |
| 8.20 | PMLIMITU1—Prefetchable Memory Limit Address Upper | 245 |
| 8.21 | CAPPTR1—Capabilities Pointer | 246 |
| 8.22 | INTRLINE1—Interrupt Line..... | 246 |
| 8.23 | INTRPIN1—Interrupt Pin | 246 |
| 8.24 | BCTRL1—Bridge Control | 247 |
| 8.25 | PM_CAPID1—Power Management Capabilities | 248 |
| 8.26 | PM_CS1—Power Management Control/Status | 249 |
| 8.27 | SS_CAPID—Subsystem ID and Vendor ID Capabilities | 250 |
| 8.28 | SS—Subsystem ID and Subsystem Vendor ID..... | 250 |
| 8.29 | MSI_CAPID—Message Signaled Interrupts Capability ID | 251 |
| 8.30 | MC—Message Control | 251 |
| 8.31 | MA—Message Address | 252 |
| 8.32 | MD—Message Data | 252 |
| 8.33 | PE_CAPL—PCI Express* Capability List | 252 |
| 8.34 | PE_CAP—PCI Express* Capabilities | 253 |
| 8.35 | DCAP—Device Capabilities | 253 |
| 8.36 | DCTL—Device Control..... | 254 |
| 8.37 | DSTS—Device Status | 255 |
| 8.38 | LCAP—Link Capabilities..... | 256 |
| 8.39 | LCTL—Link Control..... | 257 |
| 8.40 | LSTS—Link Status..... | 259 |
| 8.41 | SLOTCAP—Slot Capabilities | 261 |
| 8.42 | SLOTCTL—Slot Control | 262 |
| 8.43 | SLOTSTS—Slot Status | 264 |
| 8.44 | RCTL—Root Control..... | 265 |
| 8.45 | RSTS—Root Status | 266 |
| 8.46 | PELC—PCI Express Legacy Control | 266 |
| 8.47 | VCECH—Virtual Channel Enhanced Capability Header..... | 267 |
| 8.48 | PVCCAP1—Port VC Capability Register 1 | 267 |
| 8.49 | PVCCAP2—Port VC Capability Register 2 | 268 |
| 8.50 | PVCCCTL—Port VC Control | 268 |
| 8.51 | VCORCAP—VC0 Resource Capability | 269 |
| 8.52 | VCORCTL—VC0 Resource Control | 270 |
| 8.53 | VCORSTS—VC0 Resource Status | 271 |
| 8.54 | RCLDECH—Root Complex Link Declaration Enhanced | 271 |
| 8.55 | ESD—Element Self Description | 272 |
| 8.56 | LE1D—Link Entry 1 Description..... | 272 |
| 8.57 | LE1A—Link Entry 1 Address | 273 |

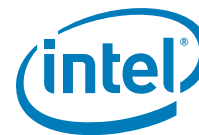

| | | |
|----------|-------------------------------------------------------------------------------------------------------------------|-----|
| 9 | Integrated Graphics Registers (Device 2) (Intel® 82Q45, 82Q43, 82B43, 82G45, 82G43, 82G41 GMCH Only) | 275 |
| 9.1 | Integrated Graphics Registers (D2:F0) | 275 |
| 9.1.1 | VID2—Vendor Identification | 277 |
| 9.1.2 | DID2—Device Identification | 277 |
| 9.1.3 | PCICMD2—PCI Command | 278 |
| 9.1.4 | PCISTS2—PCI Status | 279 |
| 9.1.5 | RID2—Revision Identification | 280 |
| 9.1.6 | CC—Class Code | 280 |
| 9.1.7 | CLS—Cache Line Size | 281 |
| 9.1.8 | MLT2—Master Latency Timer | 281 |
| 9.1.9 | HDR2—Header Type | 281 |
| 9.1.10 | GTTMMADR—Graphics Translation Table, Memory Mapped Range Address ... | 282 |
| 9.1.11 | GMADR—Graphics Memory Range Address | 283 |
| 9.1.12 | IOBAR—I/O Base Address | 284 |
| 9.1.13 | SVID2—Subsystem Vendor Identification | 284 |
| 9.1.14 | SID2—Subsystem Identification | 285 |
| 9.1.15 | ROMADR—Video BIOS ROM Base Address | 285 |
| 9.1.16 | CAPPOINT—Capabilities Pointer | 285 |
| 9.1.17 | INTRLINE—Interrupt Line | 286 |
| 9.1.18 | INTRPIN—Interrupt Pin | 286 |
| 9.1.19 | MINGNT—Minimum Grant | 286 |
| 9.1.20 | MAXLAT—Maximum Latency | 287 |
| 9.1.21 | CAPID0—Capability Identifier | 287 |
| 9.1.22 | MGGC—GMCH Graphics Control Register | 288 |
| 9.1.23 | DEVEN—Device Enable | 290 |
| 9.1.24 | SSRW—Software Scratch Read Write | 292 |
| 9.1.25 | BSM—Base of Stolen Memory | 292 |
| 9.1.26 | HSRW—Hardware Scratch Read Write | 292 |
| 9.1.27 | MC—Message Control | 293 |
| 9.1.28 | MA—Message Address | 293 |
| 9.1.29 | MD—Message Data | 294 |
| 9.1.30 | GDRST—Graphics Debug Reset | 294 |
| 9.1.31 | PMCAPID—Power Management Capabilities ID | 295 |
| 9.1.32 | PMCAP—Power Management Capabilities | 295 |
| 9.1.33 | PMCS—Power Management Control/Status | 296 |
| 9.1.34 | SWSMI—Software SMI | 296 |
| 9.2 | Integrated Graphics Registers (D2:F1) | 297 |
| 9.2.1 | VID2—Vendor Identification | 298 |
| 9.2.2 | DID2—Device Identification | 298 |
| 9.2.3 | PCICMD2—PCI Command | 299 |
| 9.2.4 | PCISTS2—PCI Status | 300 |
| 9.2.5 | RID2—Revision Identification | 301 |
| 9.2.6 | CC—Class Code Register | 301 |
| 9.2.7 | CLS—Cache Line Size | 302 |
| 9.2.8 | MLT2—Master Latency Timer | 302 |
| 9.2.9 | HDR2—Header Type | 302 |
| 9.2.10 | MMADR—Memory Mapped Range Address | 303 |
| 9.2.11 | SVID2—Subsystem Vendor Identification | 303 |
| 9.2.12 | SID2—Subsystem Identification | 304 |
| 9.2.13 | ROMADR—Video BIOS ROM Base Address | 304 |
| 9.2.14 | CAPPOINT—Capabilities Pointer | 304 |
| 9.2.15 | MINGNT—Minimum Grant | 305 |
| 9.2.16 | MAXLAT—Maximum Latency | 305 |
| 9.2.17 | CAPID0—Mirror of Dev0 Capability Identifier | 305 |

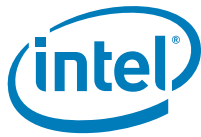

| | | |
|-----------|----------------------------------------------------------------------|------------|
| 9.2.18 | MGGC—Mirror of Device 0 GMCH Graphics Control Register | 306 |
| 9.2.19 | DEVEN—Device Enable | 308 |
| 9.2.20 | SSRW—Mirror of Function 0 Software Scratch Read Write | 309 |
| 9.2.21 | BSM—Mirror of Function 0 Base of Stolen Memory | 310 |
| 9.2.22 | HSRW—Mirror of Device 2 Function 0 Hardware Scratch Read Write | 310 |
| 9.2.23 | GDRST—Mirror of Device 2 Function 0 Graphics Reset | 311 |
| 9.2.24 | PMCAPID—Mirror of Fun 0 Power Management Capabilities ID | 312 |
| 9.2.25 | PMCAP—Mirror of Fun 0 Power Management Capabilities | 312 |
| 9.2.26 | PMCS—Power Management Control/Status | 313 |
| 9.2.27 | SWSMI—Mirror of Func0 Software SMI | 313 |
| 10 | Intel® Manageability Engine Subsystem Registers | 315 |
| 10.1 | HECI Function in ME subsystem Registers | 315 |
| 10.1.1 | ID— Identifiers | 316 |
| 10.1.2 | CMD— Command | 316 |
| 10.1.3 | STS— Device Status | 317 |
| 10.1.4 | RID— Revision ID | 318 |
| 10.1.5 | CC— Class Code | 318 |
| 10.1.6 | CLS— Cache Line Size | 319 |
| 10.1.7 | MLT— Master Latency Timer | 319 |
| 10.1.8 | HTYPE— Header Type | 319 |
| 10.1.9 | BIST— Built In Self Test | 320 |
| 10.1.10 | HECI_MBAR— HECI MMIO Base Address | 320 |
| 10.1.11 | SS— Sub System Identifiers | 321 |
| 10.1.12 | CAP— Capabilities Pointer | 321 |
| 10.1.13 | INTR— Interrupt Information | 322 |
| 10.1.14 | MGNT— Minimum Grant | 322 |
| 10.1.15 | MLAT— Maximum Latency | 322 |
| 10.1.16 | HFS— Host Firmware Status | 323 |
| 10.1.17 | PID— PCI Power Management Capability ID | 323 |
| 10.1.18 | PC— PCI Power Management Capabilities | 324 |
| 10.1.19 | PMCS— PCI Power Management Control And Status | 325 |
| 10.1.20 | MID— Message Signaled Interrupt Identifiers | 326 |
| 10.1.21 | MC— Message Signaled Interrupt Message Control | 326 |
| 10.1.22 | MA— Message Signaled Interrupt Message Address | 326 |
| 10.1.23 | MUA— Message Signaled Interrupt Upper Address (Optional) | 327 |
| 10.1.24 | MD— Message Signaled Interrupt Message Data | 327 |
| 10.2 | Second HECI Function in ME Subsystem Registers | 328 |
| 10.2.1 | ID— Identifiers | 329 |
| 10.2.2 | CMD— Command | 329 |
| 10.2.3 | STS— Device Status | 330 |
| 10.2.4 | RID—Revision ID | 331 |
| 10.2.5 | CC— Class Code | 331 |
| 10.2.6 | CLS— Cache Line Size | 332 |
| 10.2.7 | MLT— Master Latency Timer | 332 |
| 10.2.8 | HTYPE— Header Type | 332 |
| 10.2.9 | HECI_MBAR— HECI MMIO Base Address | 333 |
| 10.2.10 | SS— Sub System Identifiers | 333 |
| 10.2.11 | CAP— Capabilities Pointer | 334 |
| 10.2.12 | INTR— Interrupt Information | 334 |
| 10.2.13 | MGNT— Minimum Grant | 334 |
| 10.2.14 | MLAT— Maximum Latency | 335 |
| 10.2.15 | HFS— Host Firmware Status | 335 |
| 10.2.16 | PID— PCI Power Management Capability ID | 335 |
| 10.2.17 | PC— PCI Power Management Capabilities | 336 |

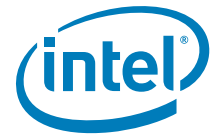

| | | |
|---------|------------------------------------------------------------------------|-----|
| 10.2.18 | PMCS— PCI Power Management Control And Status | 337 |
| 10.2.19 | MID— Message Signaled Interrupt Identifiers | 338 |
| 10.2.20 | MC— Message Signaled Interrupt Message Control..... | 338 |
| 10.2.21 | MA— Message Signaled Interrupt Message Address..... | 338 |
| 10.2.22 | MUA— Message Signaled Interrupt Upper Address (Optional) | 339 |
| 10.2.23 | MD— Message Signaled Interrupt Message Data | 339 |
| 10.2.24 | HIDM—HECI Interrupt Delivery Mode | 339 |
| 10.3 | HECI PCI MMIO Space Registers | 340 |
| 10.3.1 | H_CB_WW— Host Circular Buffer Write Window..... | 340 |
| 10.3.2 | H_CSR— Host Control Status | 341 |
| 10.3.3 | ME_CB_RW— ME Circular Buffer Read Window | 342 |
| 10.3.4 | ME_CSR_HA— ME Control Status Host Access | 343 |
| 10.4 | Second HECI Function MMIO Space Registers..... | 344 |
| 10.4.1 | H_CB_WW— Host Circular Buffer Write Window..... | 344 |
| 10.4.2 | H_CSR— Host Control Status | 345 |
| 10.4.3 | ME_CB_RW— ME Circular Buffer Read Window | 346 |
| 10.4.4 | ME_CSR_HA— ME Control Status Host Access | 347 |
| 10.5 | IDE Function for Remote Boot and Installations PT IDER Registers | 348 |
| 10.5.1 | ID—Identification | 349 |
| 10.5.2 | CMD—Command Register | 349 |
| 10.5.3 | STS—Device Status | 350 |
| 10.5.4 | RID—Revision ID..... | 351 |
| 10.5.5 | CC—Class Codes | 351 |
| 10.5.6 | CLS—Cache Line Size..... | 351 |
| 10.5.7 | MLT—Master Latency Timer | 352 |
| 10.5.8 | PCMDBA—Primary Command Block IO Bar | 352 |
| 10.5.9 | PCTLBA—Primary Control Block Base Address | 353 |
| 10.5.10 | SCMDBA—Secondary Command Block Base Address | 353 |
| 10.5.11 | SCTLBA—Secondary Control Block base Address..... | 354 |
| 10.5.12 | LBAR—Legacy Bus Master Base Address | 354 |
| 10.5.13 | SS—Sub System Identifiers | 355 |
| 10.5.14 | EROM—Expansion ROM Base Address..... | 355 |
| 10.5.15 | CAP—Capabilities Pointer..... | 355 |
| 10.5.16 | INTR—Interrupt Information | 356 |
| 10.5.17 | MGNT—Minimum Grant | 356 |
| 10.5.18 | MLAT—Maximum Latency | 356 |
| 10.5.19 | PID—PCI Power Management Capability ID | 357 |
| 10.5.20 | PC—PCI Power Management Capabilities | 357 |
| 10.5.21 | PMCS—PCI Power Management Control and Status | 358 |
| 10.5.22 | MID—Message Signaled Interrupt Capability ID | 359 |
| 10.5.23 | MC—Message Signaled Interrupt Message Control..... | 359 |
| 10.5.24 | MA—Message Signaled Interrupt Message Address..... | 360 |
| 10.5.25 | MAU—Message Signaled Interrupt Message Upper Address | 360 |
| 10.5.26 | MD—Message Signaled Interrupt Message Data | 360 |
| 10.6 | IDE BAR0 | 361 |
| 10.6.1 | IDEDATA—IDE Data Register | 362 |
| 10.6.2 | IDEERD1—IDE Error Register Device 1 | 362 |
| 10.6.3 | IDEERD0—IDE Error Register DEVO | 363 |
| 10.6.4 | IDEFR—IDE Features Register | 363 |
| 10.6.5 | IDESCIR—IDE Sector Count In Register..... | 364 |
| 10.6.6 | IDESCOR1—IDE Sector Count Out Register Dev1..... | 364 |
| 10.6.7 | IDESCOR0—IDE Sector Count Out Register Device 0..... | 365 |
| 10.6.8 | IDESNOR0—IDE Sector Number Out Register Device 0..... | 365 |
| 10.6.9 | IDESNOR1—IDE Sector Number Out Register Device 1 | 366 |
| 10.6.10 | IDESNIR—IDE Sector Number In Register..... | 366 |

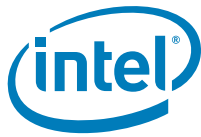

| | | |
|---------|-------------------------------------------------------------------------------|-----|
| 10.6.11 | IDECLIR—IDE Cylinder Low In Register | 367 |
| 10.6.12 | IDCLOR1—IDE Cylinder Low Out Register Device 1 | 367 |
| 10.6.13 | IDCLOR0—IDE Cylinder Low Out Register Device 0 | 368 |
| 10.6.14 | IDCHOR0—IDE Cylinder High Out Register Device 0 | 368 |
| 10.6.15 | IDCHOR1—IDE Cylinder High Out Register Device 1 | 369 |
| 10.6.16 | IDECHIR—IDE Cylinder High In Register | 369 |
| 10.6.17 | IDEDHIR—IDE Drive/Head In Register | 370 |
| 10.6.18 | IDDHOR1—IDE Drive Head Out Register Device 1 | 370 |
| 10.6.19 | IDDHOR0—IDE Drive Head Out Register Device 0 | 371 |
| 10.6.20 | IDESD0R—IDE Status Device 0 Register | 372 |
| 10.6.21 | IDESD1R—IDE Status Device 1 Register | 373 |
| 10.6.22 | IDECCR—IDE Command Register | 374 |
| 10.7 | IDE BAR1 | 375 |
| 10.7.1 | IDDCR—IDE Device Control Register | 375 |
| 10.7.2 | IDASR—IDE Alternate status Register | 376 |
| 10.8 | IDE BAR4 | 377 |
| 10.8.1 | IDEPBMCRCR—IDE Primary Bus Master Command Register | 378 |
| 10.8.2 | IDEPBMSOR—IDE Primary Bus Master Device Specific 0 Register | 378 |
| 10.8.3 | IDEPBMSR—IDE Primary Bus Master Status Register | 379 |
| 10.8.4 | IDEPBMS1R—IDE Primary Bus Master Device Specific 1 Register | 380 |
| 10.8.5 | IDEPBMDTPRO—IDE Primary Bus Master Descriptor Table Pointer Register Byte 0 | 380 |
| 10.8.6 | IDEPBMDTPR1—IDE Primary Bus Master Descriptor Table Pointer Register Byte 1 | 380 |
| 10.8.7 | IDEPBMDTPR2—IDE Primary Bus Master Descriptor Table Pointer Register Byte 2 | 381 |
| 10.8.8 | IDEPBMDTPR3—IDE Primary Bus Master Descriptor Table Pointer Register Byte 3 | 381 |
| 10.8.9 | IDESBMCR—IDE Secondary Bus Master Command Register | 382 |
| 10.8.10 | IDESBMDSOR—IDE Secondary Bus Master Device Specific 0 Register | 382 |
| 10.8.11 | IDESBMSR—IDE Secondary Bus Master Status Register | 383 |
| 10.8.12 | IDESBMDS1R—IDE Secondary Bus Master Device Specific 1 Register | 383 |
| 10.8.13 | IDESBMDTPRO—IDE Secondary Bus Master Descriptor Table Pointer Register Byte 0 | 384 |
| 10.8.14 | IDESBMDTPR1—IDE Secondary Bus Master Descriptor Table Pointer Register Byte 1 | 384 |
| 10.8.15 | IDESBMDTPR2—IDE Secondary Bus Master Descriptor Table Pointer Register Byte 2 | 384 |
| 10.8.16 | IDESBMDTPR3—IDE Secondary Bus Master Descriptor Table Pointer Register Byte 3 | 385 |
| 10.9 | Serial Port for Remote Keyboard and Text (KT) Redirection | 386 |
| 10.9.1 | ID—Identification | 387 |
| 10.9.2 | CMD—Command Register | 387 |
| 10.9.3 | STS—Device Status | 388 |
| 10.9.4 | RID—Revision ID | 389 |
| 10.9.5 | CC—Class Codes | 389 |
| 10.9.6 | CLS—Cache Line Size | 389 |
| 10.9.7 | MLT—Master Latency Timer | 390 |
| 10.9.8 | HTYPE—Header Type | 390 |
| 10.9.9 | BIST—Built In Self Test | 390 |
| 10.9.10 | KTIBA—KT IO Block Base Address | 391 |
| 10.9.11 | KT MBA—KT Memory Block Base Address | 391 |
| 10.9.12 | RSVD—Reserved | 392 |
| 10.9.13 | RSVD—Reserved | 392 |
| 10.9.14 | RSVD—Reserved | 392 |

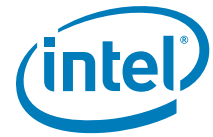

| | | |
|-----------|---------------------------------------------------------------------------------------------|------------|
| 10.9.15 | RSVD—Reserved | 392 |
| 10.9.16 | SS—Sub System Identifiers | 393 |
| 10.9.17 | EROM—Expansion ROM Base Address | 393 |
| 10.9.18 | CAP—Capabilities Pointer | 393 |
| 10.9.19 | INTR—Interrupt Information | 394 |
| 10.9.20 | MGNT—Minimum Grant | 394 |
| 10.9.21 | MLAT—Maximum Latency | 394 |
| 10.9.22 | PID—PCI Power Management Capability ID | 395 |
| 10.9.23 | PC—PCI Power Management Capabilities | 395 |
| 10.9.24 | PMCS—PCI Power Management Control and Status | 396 |
| 10.9.25 | MID—Message Signaled Interrupt Capability ID | 397 |
| 10.9.26 | MC—Message Signaled Interrupt Message Control | 397 |
| 10.9.27 | MA—Message Signaled Interrupt Message Address | 398 |
| 10.9.28 | MAU—Message Signaled Interrupt Message Upper Address | 398 |
| 10.9.29 | MD—Message Signaled Interrupt Message Data | 398 |
| 10.10 | KT IO/ Memory Mapped Device Registers | 399 |
| 10.10.1 | KTRxBR—KT Receive Buffer Register | 399 |
| 10.10.2 | KTTHR—KT Transmit Holding Register | 400 |
| 10.10.3 | KTDLLR—KT Divisor Latch LSB Register | 400 |
| 10.10.4 | KTIER—KT Interrupt Enable Register | 401 |
| 10.10.5 | KTDLMR—KT Divisor Latch MSB Register | 401 |
| 10.10.6 | KTIIR—KT Interrupt Identification Register | 402 |
| 10.10.7 | KTFCR—KT FIFO Control Register | 403 |
| 10.10.8 | KTLCR—KT Line Control Register | 404 |
| 10.10.9 | KTMCR—KT Modem Control Register | 405 |
| 10.10.10 | KTLSR—KT Line Status Register | 406 |
| 10.10.11 | KTMSR—KT Modem Status Register | 407 |
| 10.10.12 | KTSCR—KT Scratch Register | 407 |
| 11 | Intel® Trusted Execution Technology Registers (Intel® 82Q45 and 82Q43 GMCH Only) | 409 |
| 11.1 | Intel Trusted Execution Technology Specific Registers | 409 |
| 11.1.1 | TXT.STS—TXT Status Register | 411 |
| 11.1.2 | TXT.ESTS—TXT Error Status Register | 412 |
| 11.1.3 | TXT.THREAD.EXISTS—TXT Thread Exists Register | 413 |
| 11.1.4 | TXT.THREADS.JOIN—TXT Threads Join Register | 414 |
| 11.1.5 | TXT.ERRORCODE (AKA TXT.CRASH)—TXT Error Code Register | 415 |
| 11.1.6 | TXT.CMD.RESET—TXT System Reset Command | 415 |
| 11.1.7 | TXT.CMD.CLOSE-PRIVATE—TXT Close Private Command | 415 |
| 11.1.8 | TXT.DID—TXT Device ID Register | 416 |
| 11.1.9 | TXT.CMD.FLUSH-WB—TXT Flush Write Buffer Command | 416 |
| 11.1.10 | TXT.SINIT.MEMORY.BASE—TXT SINIT Code Base Register | 416 |
| 11.1.11 | TXT.SINIT.MEMORY.SIZE—TXT SINIT Memory Size Register | 417 |
| 11.1.12 | TXT.MLE.JOIN—TXT MLE Join Base Register | 417 |
| 11.1.13 | TXT.HEAP.BASE—TXT Heap Base Register | 418 |
| 11.1.14 | TXT.HEAP.SIZE—TXT Heap Size Register | 418 |
| 11.1.15 | TXT.MSEG.BASE—TXT MSEG Base Register | 418 |
| 11.1.16 | TXT.MSEG.SIZE—TXT MSEG Size Address Register | 419 |
| 11.1.17 | TXT.SCRATCHPAD.0—TXT Scratch Pad 0 Register | 419 |
| 11.1.18 | TXT.SCRATCHPAD.1—TXT Scratch Pad 1 Register | 419 |
| 11.1.19 | TXT.DPR—DMA Protected Range | 420 |
| 11.1.20 | TXT.CMD.OPEN.LOCALITY1—TXT Open Locality 1 Command | 420 |
| 11.1.21 | TXT.CMD.CLOSE.LOCALITY1—TXT Close Locality 1 Command | 421 |
| 11.1.22 | TXT.CMD.OPEN.LOCALITY2—TXT Open Locality 2 Command | 421 |
| 11.1.23 | TXT.CMD.CLOSE.LOCALITY2—TXT Close Locality 2 Command | 421 |

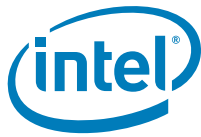

| | | |
|-----------|-----------------------------------------------------------------------------------------------------------|------------|
| 11.1.24 | TXT.PUBLIC.KEY—TXT Chipset Public Key Hash | 421 |
| 11.1.25 | TXT.CMD.SECRETS—TXT Secrets Command | 422 |
| 11.1.26 | TXT.CMD.NO-SECRETS—TXT Secrets Command | 422 |
| 11.1.27 | TXT.E2STS—TXT Extended Error Status Register | 422 |
| 11.2 | Intel® TXT Memory Map | 423 |
| 11.2.1 | Intel® TXT Private Space | 423 |
| 11.2.2 | Intel® TXT Public Space | 423 |
| 11.2.3 | TPM Decode Area | 423 |
| 12 | Intel® Virtualization Technology for Directed I/O Registers (D0:F0) (Intel® 82Q45 GMCH Only) | 425 |
| 12.1 | DMI and PEG VC0/VCp Remap Registers | 425 |
| 12.1.1 | VER_REG—Version Register | 426 |
| 12.1.2 | CAP_REG—Capability Register | 426 |
| 12.1.3 | ECAP_REG—Extended Capability Register | 430 |
| 12.1.4 | GCMD_REG—Global Command Register | 432 |
| 12.1.5 | GSTS_REG—Global Status Register | 437 |
| 12.1.6 | RTADDR_REG—Root-Entry Table Address Register | 438 |
| 12.1.7 | CCMD_REG—Context Command Register | 439 |
| 12.1.8 | FSTS_REG—Fault Status Register | 442 |
| 12.1.9 | FECTL_REG—Fault Event Control Register | 444 |
| 12.1.10 | FEDATA_REG—Fault Event Data Register | 445 |
| 12.1.11 | FEADDR_REG—Fault Event Address Register | 445 |
| 12.1.12 | FEUADDR_REG—Fault Event Upper Address Register | 446 |
| 12.1.13 | AFLOG_REG—Advanced Fault Log Register | 447 |
| 12.1.14 | PMEN_REG—Protected Memory Enable Register | 448 |
| 12.1.15 | PLMBASE_REG—Protected Low-Memory Base Register | 449 |
| 12.1.16 | PLMLIMIT_REG—Protected Low-Memory Limit Register | 450 |
| 12.1.17 | PHMBASE_REG—Protected High-Memory Base Register | 451 |
| 12.1.18 | PHMLIMIT_REG—Protected High-Memory Limit Register | 452 |
| 12.1.19 | IVA_REG—Invalidate Address Register | 453 |
| 12.2 | DMI VC1 Remap Engine Registers | 455 |
| 12.2.1 | VER_REG—Version Register | 456 |
| 12.2.2 | CAP_REG—Capability Register | 456 |
| 12.2.3 | ECAP_REG—Extended Capability Register | 460 |
| 12.2.4 | GCMD_REG—Global Command Register | 462 |
| 12.2.5 | GSTS_REG—Global Status Register | 466 |
| 12.2.6 | RTADDR_REG—Root-Entry Table Address Register | 468 |
| 12.2.7 | CCMD_REG—Context Command Register | 469 |
| 12.2.8 | FSTS_REG—Fault Status Register | 471 |
| 12.2.9 | FECTL_REG—Fault Event Control Register | 473 |
| 12.2.10 | FEDATA_REG—Fault Event Data Register | 475 |
| 12.2.11 | FEADDR_REG—Fault Event Address Register | 475 |
| 12.2.12 | FEUADDR_REG—Fault Event Upper Address Register | 476 |
| 12.2.13 | AFLOG_REG—Advanced Fault Log Register | 477 |
| 12.2.14 | PMEN_REG—Protected Memory Enable Register | 478 |
| 12.2.15 | PLMBASE_REG—Protected Low-Memory Base Register | 479 |
| 12.2.16 | PLMLIMIT_REG—Protected Low-Memory Limit Register | 480 |
| 12.2.17 | PHMBASE_REG—Protected High-Memory Base Register | 481 |
| 12.2.18 | PHMLIMIT_REG—Protected High-Memory Limit Register | 482 |
| 12.2.19 | IVA_REG—Invalidate Address Register | 483 |
| 12.2.20 | IOTLB_REG—IOTLB Invalidate Register | 485 |
| 12.2.21 | FRCD_REG—Fault Recording Registers | 488 |
| 12.3 | GFXVTBAR | 489 |
| 12.3.1 | VER_REG—Version Register | 490 |

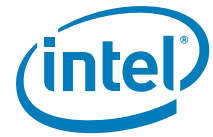

| | | |
|-----------|------------------------------------------------------------------------------------------|------------|
| 12.3.2 | CAP_REG—Capability Register | 490 |
| 12.3.3 | ECAP_REG—Extended Capability Register | 495 |
| 12.3.4 | GCMD_REG—Global Command Register | 497 |
| 12.3.5 | GSTS_REG—Global Status Register | 502 |
| 12.3.6 | RTADDR_REG—Root-Entry Table Address Register | 503 |
| 12.3.7 | CCMD_REG—Context Command Register | 504 |
| 12.3.8 | FSTS_REG—Fault Status Register | 506 |
| 12.3.9 | FECTL_REG—Fault Event Control Register | 508 |
| 12.3.10 | FEDATA_REG—Fault Event Data Register | 509 |
| 12.3.11 | FEADDR_REG—Fault Event Address Register | 509 |
| 12.3.12 | FEUADDR_REG—Fault Event Upper Address Register | 510 |
| 12.3.13 | AFLOG_REG—Advanced Fault Log Register | 510 |
| 12.3.14 | PMEN_REG—Protected Memory Enable Register | 511 |
| 12.3.15 | PLMBASE_REG—Protected Low Memory Base Register | 512 |
| 12.3.16 | PLMLIMIT_REG—Protected Low Memory Limit Register | 513 |
| 12.3.17 | PHMBASE_REG—Protected High Memory Base Register | 514 |
| 12.3.18 | PHMLIMIT_REG—Protected High Memory Limit Register | 515 |
| 12.3.19 | IVA_REG—Invalidate Address Register | 516 |
| 12.3.20 | IOTLB_REG—IOTLB Invalidate Register | 518 |
| 12.3.21 | FRCD_REG—Fault Recording Registers | 522 |
| 13 | Functional Description | 525 |
| 13.1 | Host Interface | 525 |
| 13.1.1 | FSB IOQ Depth | 525 |
| 13.1.2 | FSB OoQ Depth | 525 |
| 13.1.3 | FSB GTL+ Termination | 525 |
| 13.1.4 | FSB Dynamic Bus Inversion | 525 |
| 13.1.5 | APIC Cluster Mode Support | 526 |
| 13.2 | System Memory Controller | 527 |
| 13.2.1 | System Memory Organization Modes | 527 |
| 13.2.1.1 | Single Channel Mode | 527 |
| 13.2.1.2 | Dual Channel Modes | 527 |
| 13.2.2 | System Memory Technology Supported | 529 |
| 13.3 | PCI Express* | 530 |
| 13.3.1 | PCI Express* Architecture | 530 |
| 13.3.1.1 | Transaction Layer | 530 |
| 13.3.1.2 | Data Link Layer | 530 |
| 13.3.1.3 | Physical Layer | 530 |
| 13.3.2 | PCI Express* on (G)MCH | 530 |
| 13.4 | Integrated Graphics Device (Intel® 82Q45, 82Q43, 82B43, 82G45, 82G43 GMCH Only) | 532 |
| 13.4.1 | 3D and Video Engines for Graphics Processing | 532 |
| 13.4.1.1 | 3D Engine Execution Units (EUs) | 533 |
| 13.4.1.2 | 3D Pipeline | 533 |
| 13.4.2 | Video Engine | 534 |
| 13.4.3 | 2D Engine | 534 |
| 13.4.3.1 | Chipset VGA Registers | 534 |
| 13.4.3.2 | Logical 128-Bit Fixed BLT and 256 Fill Engine | 534 |
| 13.5 | Display Interfaces (Intel® 82Q45, 82Q43, 82B43, 82G45, 82G43, 82G41 GMCH Only) | 535 |
| 13.5.1 | Analog Display Port Characteristics | 535 |
| 13.5.1.1 | Integrated RAMDAC | 536 |
| 13.5.1.2 | Sync Signals | 536 |
| 13.5.1.3 | VESA/VGA Mode | 536 |
| 13.5.1.4 | DDC (Display Data Channel) | 536 |
| 13.5.2 | Digital Display Interface | 536 |



| | | |
|-----------|---------------------------------------------------------------------------------------------------------------|------------|
| 13.5.2.1 | High Definition Multimedia Interface (Intel® 82G45, 82G43, 82G41, 82B43 GMCH Only)..... | 536 |
| 13.5.2.2 | Digital Video Interface (DVI) | 537 |
| 13.5.2.3 | DDPC_CTRLDATA and DDPC_CTRLCLK | 537 |
| 13.5.2.4 | Display Port..... | 538 |
| 13.5.2.5 | Auxiliary Channel (AUX CH) | 538 |
| 13.5.2.6 | PEG Mapping of digital display signals | 538 |
| 13.5.2.7 | Multiplexed Digital Display Channels – Intel® SDVOB and Intel® SDVOC | 540 |
| 13.5.3 | Multiple Display Configurations | 542 |
| 13.5.3.1 | High Bandwidth Digital Content Protection (HDCP) | 542 |
| 13.6 | Intel® Virtualization Technology for I/O Devices (Intel® 82Q45 GMCH Only)..... | 543 |
| 13.6.1 | Overview | 543 |
| 13.6.2 | Embedded IT Client Usage Model | 543 |
| 13.6.2.1 | Intel Virtualization Technology for I/O Devices Enables..... | 544 |
| 13.6.2.2 | Hardware Versus Software Virtualization | 544 |
| 13.6.2.3 | Hardware Virtualization Advantages..... | 544 |
| 13.6.3 | Concept of DMA Address Remapping | 544 |
| 13.7 | Intel® Trusted Execution Technology (Intel® TXT) (Intel® 82Q45 and 82Q43 GMCH Only)..... | 545 |
| 13.8 | Intel® Management Engine (ME) Subsystem | 546 |
| 13.8.1 | ME Host Visible Functional Blocks | 546 |
| 13.8.2 | ME Power States..... | 547 |
| 13.8.3 | Host/ME State Transitions..... | 547 |
| 13.9 | Thermal Sensor | 548 |
| 13.9.1 | PCI Device 0, Function 0..... | 548 |
| 13.9.2 | GMCHBAR Thermal Sensor Registers | 548 |
| 13.10 | Power Management..... | 549 |
| 13.10.1 | Main memory Power Management..... | 549 |
| 13.10.2 | Interface Power States Supported..... | 550 |
| 13.10.3 | Chipset State Combinations | 551 |
| 13.11 | Clocking | 553 |
| 14 | Electrical Characteristics | 555 |
| 14.1 | Absolute Minimum and Maximum Ratings..... | 555 |
| 14.2 | Current Consumption | 556 |
| 14.3 | (G)MCH Buffer Supply and DC Characteristics..... | 560 |
| 14.3.1 | I/O Buffer Supply Voltages..... | 560 |
| 14.3.2 | General DC Characteristics..... | 562 |
| 14.3.3 | R, G, B / CRT DAC Display DC Characteristics (Intel® 82Q45, 82Q43, 82B43, 82G45, 82G43, 82G41 GMCH Only)..... | 566 |
| 14.3.4 | Di/dt Characteristics..... | 566 |
| 15 | Ballout and Package Specifications | 569 |
| 15.1 | Ballout | 569 |
| 15.2 | Package Specifications..... | 597 |
| 16 | Testability | 599 |
| 16.1 | JTAG Boundary Scan..... | 599 |
| 16.1.1 | TAP Instructions and Opcodes | 600 |
| 16.1.2 | TAP interface and timings. | 600 |
| 16.2 | XOR Test Mode Initialization..... | 602 |
| 16.2.1 | XOR Chain Definition..... | 603 |

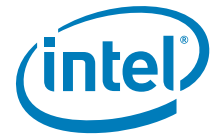

Figures

| | | |
|----|------------------------------------------------------------------------|-----|
| 1 | Intel® Q45, Q43, B43, G45, G43 Chipset System Block Diagram Example | 24 |
| 2 | Intel® P45, P43 Chipset System Block Diagram Example | 25 |
| 3 | Intel® G41 Express Chipset System Block Diagram Example | 26 |
| 4 | System Address Ranges | 56 |
| 5 | DOS Legacy Address Range | 57 |
| 6 | Main Memory Address Range | 61 |
| 7 | PCI Memory Address Range | 64 |
| 8 | Memory Map to PCI Express Device Configuration Space | 79 |
| 9 | MCH Configuration Cycle Flow Chart | 80 |
| 10 | GMCH Graphics Controller Block Diagram | 532 |
| 11 | HDMI Overview | 537 |
| 12 | Display Port Overview | 538 |
| 13 | Display configurations on ATX Platforms | 540 |
| 14 | Display Configurations on Balanced Technology Extended (BTX) Platforms | 541 |
| 15 | Example of EIT Usage Model | 543 |
| 16 | DMA Address Translation | 545 |
| 17 | Platform Clocking Diagram | 554 |
| 18 | GMCH Ballout Diagram (Top View Left – Columns 45–31) | 570 |
| 19 | GMCH Ballout Diagram (Top View Left – Columns 30–16) | 571 |
| 20 | GMCH Ballout Diagram (Top View Left – Columns 15–1) | 572 |
| 21 | (G)MCH Package Drawing | 597 |
| 22 | JTAG Boundary Scan Test Mode Initialization Cycles | 599 |
| 23 | JTAG Test Mode Initialization Cycles | 601 |
| 24 | XOR Test Mode Initialization Cycles | 602 |

Tables

| | | |
|----|--------------------------------------------------------------------------------------------|-----|
| 1 | Intel® Series 4 Chipset High-Level Feature Component Differences | 22 |
| 2 | Intel Specification | 29 |
| 3 | SDVO, Display Port, HDMI/DVI, PCI Express* Signal Mapping | 47 |
| 4 | Expansion Area Memory Segments | 59 |
| 5 | Extended System BIOS Area Memory Segments | 59 |
| 6 | System BIOS Area Memory Segments | 60 |
| 7 | Pre-allocated Memory Example for 64 MB DRAM, 1 MB VGA, 1 MB GTT Stolen and 1 MB TSEG 62 | |
| 8 | Transaction Address Ranges – Compatible, High, and TSEG | 70 |
| 9 | SMM Space Table | 70 |
| 10 | SMM Control Table | 71 |
| 11 | DRAM Controller Register Address Map (D0:F0) | 85 |
| 12 | DRAM Rank Attribute Register Programming | 130 |
| 13 | PCI Express* Register Address Map (D1:F0) | 173 |
| 14 | Host-Secondary PCI Express* Bridge Register Address Map (D6:F0) | 229 |
| 15 | Integrated Graphics Register Address Map (D2:F0) | 275 |
| 16 | PCI Register Address Map (D2:F1) | 297 |
| 17 | HECI Function in ME Subsystem Register Address Map | 315 |
| 18 | Second HECI Function in ME Subsystem Register Address Map | 328 |
| 19 | HECI PCI MMIO space Register Address Map | 340 |
| 20 | Second HECI function MMIO Space Register Address Map | 344 |
| 21 | IDE Function for remote boot and Installations PT IDER Register Address Map | 348 |
| 22 | IDE BAR0 Register Address Map | 361 |
| 23 | IDE BAR4 Register Address Map | 377 |
| 24 | Serial Port for Remote Keyboard and Text (KT) Redirection Register Address Map | 386 |
| 25 | KT IO/ Memory Mapped Device Register Address Map | 399 |
| 26 | Intel® Virtualization Technology For Directed I/O Register Address Map | 425 |

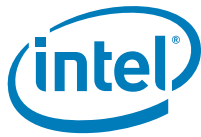

| | | |
|----|------------------------------------------------------------------------------------------------------------------------|-----|
| 27 | DMI VC1 Remap Engine Register Address Map | 455 |
| 28 | GFXVTBAR Register Address Map | 489 |
| 29 | Host Interface 4X, 2X, and 1X Signal Groups | 526 |
| 30 | Sample System Memory Dual Channel Symmetric Organization Mode | 527 |
| 31 | Sample System Memory Dual Channel Asymmetric Organization Mode with Intel® Flex Memory Mode Enabled | 528 |
| 32 | Sample System Memory Dual Channel Asymmetric Organization Mode with Intel® Flex Memory Mode Disabled | 528 |
| 33 | Supported DIMM Module Configurations | 529 |
| 34 | Supported Usage Models | 531 |
| 35 | Analog Port Characteristics | 535 |
| 36 | (G)MCH PCI Express TX/RX Mapping of Supported Display Technologies | 539 |
| 37 | Host/ME State Combinations | 547 |
| 38 | Targeted Memory State Conditions | 549 |
| 39 | Platform System States | 549 |
| 40 | Processor Power States | 550 |
| 41 | Internal Graphics Display Device Control | 550 |
| 42 | PCI Express Link States | 550 |
| 43 | Main Memory States | 550 |
| 44 | G, S, and C State Combinations | 551 |
| 45 | Interface Activity to State Mapping | 551 |
| 46 | Absolute Minimum and Maximum Ratings | 555 |
| 47 | Current Consumption in ACPI S0 State for Intel® 82G45, 82G43, 82B43, 82G41 GMCH, and 82P45, 82P43 MCH Components | 557 |
| 48 | Current Consumption in ACPI S0 state for Intel® 82Q45 and 82Q43 Components | 558 |
| 49 | Current Consumption in S3, S4, S5 with Intel® Active Management Technology Operation (Intel® 82Q45 GMCH Only) | 559 |
| 50 | I/O Buffer Supply Voltage | 560 |
| 51 | DC Characteristics | 562 |
| 52 | R, G, B / CRT DAC Display DC Characteristics: Functional Operating Range (VCCA_DAC = 3.3 V ± 5%) | 566 |
| 53 | Di/dt Simulation Data | 567 |
| 54 | GMCH Ballout Arranged by Signal Name | 573 |
| 55 | Supported TAP Instructions | 600 |
| 56 | JTAG Pins | 601 |
| 57 | JTAG Signal Timings | 601 |

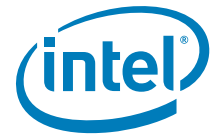

Revision History

| Revision Number | Description | Revision Date |
|-----------------|-------------------------------------------------------------------------------------------------------------------------------------------------------------------------------------------------------------------------------------------------------------------------------------------------------------------------------------------------------------------------------------------------------------------------------------------------------------------------------------------------------------------------------------------------------------------------------------------------------------------------------------------------------------------------------------------------------------------------------------------------------------------------------------------------------------------------------------------------------------------------------------------------------------------------------------------------------------------------------------------------------------------------------------------------------------------------------------------------------------------------------------------------------------------------------------------------------------------------------------------------------------------------------------------------------------------------------------------------------------------------------------------------------------------------------------------------------------------------------------------------------------------------------------------------------------------------------------------------------------------------------------------------------------------------------------------------------------------------------------------------------------------------------------------------------------------------------------------------------------------------------------------------------------------------------------------------------------------------------------------------------------------------------------------------------------------------------------------------------------------------------------------------------------------------------------------------------------------------|----------------|
| -001 | <ul style="list-style-type: none"> Initial release | June 2008 |
| -002 | <ul style="list-style-type: none"> Updated Table 1. Updated the Electrical Characteristics. | June 2008 |
| -003 | <ul style="list-style-type: none"> Added Intel 82G41 GMCH | September 2008 |
| -004 | <ul style="list-style-type: none"> Added 82Q43 and 82Q45 GMCH | September 2008 |
| -005 | <ul style="list-style-type: none"> Updated the document title to include the 82B43 GMCH Added support for 82B43 GMCH to Intel® 4 Series (G)MCH Features Chapter 1 <ul style="list-style-type: none"> Section 1: Added 82B43 GMCH in the component list and updated note for 82G41 GMCH Table 1: Updated Intel® Series 4 Chipset High-Level Feature Component Differences Figure 1: Added support for 82B43 GMCH Figure 3: Added support for ICH7R in G41 Express Chipset System Block Diagram Section 1.2.4, Section 1.2.6, Section 1.2.4.2, Section 1.2.4.3, Section 1.2.5: Added support for 82B43 GMCH Chapter 2 <ul style="list-style-type: none"> Section 2.5, Section 2.8, Section 2.10, Section 2.11: Added support for 82B43 GMCH Section 2.9: Added support for 82G41 and 82B43 GMCH Chapter 3 <ul style="list-style-type: none"> Section 3, Section 3.3, Section 3.7, Section 3.8: Added support for 82B43 GMCH Chapter 4 <ul style="list-style-type: none"> Section 4, Section 4.2.1: Added support for 82B43 GMCH Chapter 5 <ul style="list-style-type: none"> Table 11, Section 5.1.14, Section 5.1.15, Section 5.1.25, Section 5.1.32, Section 5.1.33: Added support for 82B43 GMCH Chapter 9 <ul style="list-style-type: none"> Section 9: Added support for 82B43 GMCH Chapter 13 <ul style="list-style-type: none"> Section 13.2: Added support for 82B43 GMCH and 2 DIMMs/channel support on 82G43 Section 13.4, Section 13.5: Added support for 82B43 GMCH Section 13.5.2.1: Added HDMI support for 82G41 and 82B43 GMCH Chapter 14 <ul style="list-style-type: none"> Section 14.1, Section 14.3.3, Table 47, Table 50: Added support for 82B43 GMCH Chapter 15 <ul style="list-style-type: none"> Section 15.1: Added support for 82B43 GMCH | May 2009 |
| -006 | <ul style="list-style-type: none"> Chapter 13 <ul style="list-style-type: none"> Section 13.2.2: Added clarification on system memory DRAM device technology supported for DDR2 and DDR3 | September 2009 |
| -007 | <ul style="list-style-type: none"> Chapter 13 <ul style="list-style-type: none"> Section 13.2: Updated note for DIMM support for 82B43 GMCH Chapter 14 <ul style="list-style-type: none"> Table 46 and Table 50: Updated VCC and VCC_EXP requirements for 82B43 GMCH Table 51: Added min and max spec for CL_VREF | March 2010 |

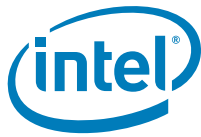

Intel[®] 4 Series (G)MCH Features

- Processor/Host Interface (FSB)
 - Supports Intel[®] Core™2 Extreme processor QX9000 series
 - Supports Intel[®] Core™2 Quad processor Q9000 series
 - Supports Intel[®] Core™2 Duo processor E8000 and E7000 series
 - 800/1067/1333 MT/s (200/266/333 MHz) FSB
 - Hyper-Threading Technology (HT Technology)
 - FSB Dynamic Bus Inversion (DBI)
 - 36-bit host bus addressing
 - 12-deep In-Order Queue
 - 1-deep Defer Queue
 - GTL+ bus driver with integrated GTL termination resistors
 - Supports cache Line Size of 64 bytes
- System Memory Interface
 - One or two channels (each channel consisting of 64 data lines)
 - Single or Dual Channel memory organization
 - DDR2-800/667 frequencies
 - DDR3-1066/800 frequencies
 - Unbuffered, non-ECC DIMMs only
 - Supports 2-Gb, 1-Gb, 512-Mb DDR2 and 1-Gb, 512-Mb DDR3 technologies for x8 and x16 devices
 - 16 GB maximum memory
- Direct Media Interface (DMI)
 - Chip-to-chip connection interface to Intel ICH10/ICH7
 - 2 GB/s point-to-point DMI to ICH9 (1 GB/s each direction)
 - 100 MHz reference clock (shared with PCI Express graphics attach)
 - 32-bit downstream addressing
 - Messaging and Error Handling
- PCI Express* Interface
 - One x16 PCI Express port
 - Compatible with the *PCI Express Base Specification, Revision 2.0*
 - Raw bit rate on data pins of 2.5 Gb/s resulting in a real bandwidth per pair of 250 MB/s
- Intel[®] Trusted Execution Technology (Intel[®] TXT) (82Q45 and 82Q43 GMCH only)
- Intel[®] Virtualization Technology (82Q45 GMCH only)
- Integrated Graphics Device (82Q45, 82Q43, 82B43, 82G45, 82G43, 82G41 GMCH only)
 - Core frequency of 400 MHz
 - 1.6 GP/s pixel rate
 - High-Quality 3D Setup and Render Engine
 - High-Quality Texture Engine
 - 3D Graphics Rendering Enhancements
 - 2D Graphics
 - Video Overlay
 - Multiple Overlay Functionality
- Analog Display (82Q45, 82Q43, 82B43, 82G45, 82G43, 82G41 GMCH only)
 - 350 MHz Integrated 24-bit RAMDAC
 - Up to 2048x1536 @ 75 Hz refresh
 - Hardware Color Cursor Support
 - DDC2B Compliant Interface
- Digital Display (82Q45, 82Q43, 82B43, 82G45, 82G43, 82G41 GMCH only)
 - SDVO ports in single mode supported
 - 200 MHz dot clock on each 12-bit interface
 - Flat panels up to 2048x1536 @ 60 Hz or digital CRT/HDTV at 1400x1050 @ 85 Hz
 - Dual independent display options with digital display
 - Multiplexed digital display channels (supported with ADD2 Card).
 - Supports TMDS transmitters or TV-Out encoders
 - ADD2/MEC card uses PCI Express graphics x16 connector
 - Two channels multiplexed with PCI Express* Graphics port
 - Supports Hot-Plug and Display
- Thermal Sensor
 - Catastrophic Trip Point support
 - Hot Trip Point support for SMI generation
- Power Management
 - PC99 suspend to DRAM support (“STR”, mapped to ACPI state S3)
 - ACPI Revision 2.0 compatible power management
 - Supports processor states: C0, C1, C2
 - Supports System states: S0, S1, S3, and S5
 - Supports processor Thermal Management 2
- Package
 - FC-BGA. 34 mm × 34 mm. The 1254 balls are located in a non-grid pattern





1 Introduction

The Intel® Intel 4 Series Chipset family is designed for use in desktop platforms. The chipset contains two components: GMCH (or MCH) for the host bridge and I/O Controller Hub 10 (ICH10) for the I/O subsystem (G45, G43, P45, P43 Express Chipset only). The ICH10 is the tenth generation I/O Controller Hub and provides a multitude of I/O related functions. The Intel G41 Chipset uses the I/O Controller Hub 7 (ICH7). [Figure 1](#), [Figure 2](#), and [Figure 3](#) show example system block diagrams for the Intel® 4 Series Chipset.

This document is the datasheet for the following components:

- Intel® 82Q45 Graphics and Memory Controller Hub (GMCH), which is part of the Intel® Q45 Chipset.
- Intel® 82Q43 Graphics and Memory Controller Hub (GMCH), which is part of the Intel® Q43 Chipset.
- Intel® 82B43 Graphics and Memory Controller Hub (GMCH), which is part of the Intel® B43 Chipset.
- Intel® 82G45 Graphics and Memory Controller Hub (GMCH), which is part of the Intel® G45 Chipset.
- Intel® 82G43 Graphics and Memory Controller Hub (GMCH), which is part of the Intel® G43 Chipset.
- Intel® 82G41 Graphics and Memory Controller Hub (GMCH), which is part of the Intel® G41 Chipset.
- Intel® 82P45 Memory Controller Hub (MCH), which is part of the Intel® P45 Chipset.
- Intel® 82P43 Memory Controller Hub (MCH), which is part of the Intel® P43 Chipset.

Topics covered include; signal description, system memory map, PCI register description, a description of the (G)MCH interfaces and major functional units, electrical characteristics, ballout definitions, and package characteristics.

Note: Unless otherwise specified, ICH10 refers to the Intel® 82801JIB ICH10, Intel® 82801JIR ICH10R, Intel® 82801JD ICH10D, Intel® 82801JDO ICH10DO I/O Controller Hub 10 components.

Note: For the 82G41 GMCH, references to ICH are references to ICH7/ICH7R.

Note: Unless otherwise specified, the information in this document applies to the Intel® 82Q45, 82Q43, 82B43, 82G45, 82G43, 82G41 Graphics and Memory Controller Hub (GMCH) and Intel® 82P45, 82P43 Memory Controller Hub (MCH).

Note: In this document the integrated graphics components are referred to as GMCH. The Intel® 82P45 and 82P43 components do not contain integrated graphics and are referred to as MCH. The term (G)MCH is used when referring to both GMCH and MCH.

[Table 1](#) provides a high-level component feature summary.



Table 1. Intel® Series 4 Chipset High-Level Feature Component Differences

| Feature | | 82Q45 GMCH | 82Q43 GMCH | 82B43 GMCH | 82G45 GMCH | 82G43 GMCH | 82G41 GMCH | 82P45 MCH | 82P43 MCH |
|----------------------------------------------------------|------|------------|------------|--------------------------|------------|------------------|------------------|-----------|-----------|
| FSB Support | | | | | | | | | |
| 1333 MHz | | Yes | Yes | Yes | Yes | Yes | Yes | Yes | Yes |
| 1067 MHz | | Yes | Yes | Yes | Yes | Yes | Yes | Yes | Yes |
| 800 MHz | | Yes | Yes | Yes | Yes | Yes | Yes | Yes | Yes |
| Memory Support | | | | | | | | | |
| DIMMs Per Channel | | 2 | 2 | 2 | 2 | 1/2 ² | 1 | 2 | 2 |
| DDR3 | 1067 | Yes | Yes | Yes | Yes | Yes | Yes | Yes | Yes |
| | 800 | Yes | Yes | Yes | Yes | Yes | Yes | Yes | Yes |
| DDR2 | 800 | Yes | Yes | Yes | Yes | Yes | Yes | Yes | Yes |
| | 667 | Yes | Yes | Yes | Yes | Yes | Yes | Yes | Yes |
| ICH Support | | | | | | | | | |
| ICH10DO | | Yes | — | — | — | — | — | — | — |
| ICH10D | | — | Yes | Yes | — | — | — | — | — |
| ICH10 | | — | — | — | Yes | Yes | — | Yes | Yes |
| ICH10R | | — | — | — | Yes | Yes | — | Yes | Yes |
| ICH7 | | — | — | — | — | — | Yes | — | — |
| ICH7R | | — | — | — | — | — | Yes ³ | — | — |
| Discrete GFX | | | | | | | | | |
| PCI Express* Gen 2, 1x16 | | Yes | Yes | Yes | Yes | Yes | — | Yes | Yes |
| PCI Express* Gen 2, 2x8 | | — | — | — | — | — | — | Yes | — |
| PCI Express* Gen 1, 1x16 | | Yes | Yes | Yes | Yes | Yes | Yes | Yes | Yes |
| PCI Express* Gen 1, 2x8 | | — | — | — | — | — | — | Yes | — |
| Internal Graphics Support — General Features | | | | | | | | | |
| 5th Generation Core | | Yes | Yes | Yes | Yes | Yes | Yes | NA | |
| DirectX 10 | | Yes | Yes | Yes | Yes | Yes | Yes | | |
| OpenGL 1.5 | | Yes | Yes | Yes | Yes | Yes | Yes | | |
| Intel Clear Video Technology | | — | — | — | Yes | Yes | Yes | | |
| Dual Independent Display | | Yes | Yes | Yes | Yes | Yes | Yes | | |
| ADD2/MEC | | Yes | Yes | Yes | Yes | Yes | Yes | | |
| HDMI* 1.3 | | — | — | Upgrad e ⁴ | Yes | Yes | Yes ³ | | |
| DVI* | | Yes | Yes | Yes | Yes | Yes | Yes | | |
| Display Port | | Yes | Yes | Yes | Yes | Yes | Yes | | |
| Integrated HDCP | | Yes | Yes | Yes | Yes | Yes | Yes | | |
| PAVP | | Yes | Yes | Yes | Yes | Yes | Yes | | |
| VGA* | | Yes | Yes | Yes | Yes | Yes | Yes | | |
| Full hardware decode acceleration of MPEG2, VC1, and AVC | | — | — | — | Yes | — | — | | |

Table 1. Intel® Series 4 Chipset High-Level Feature Component Differences

| Feature | 82Q45 GMCH | 82Q43 GMCH | 82B43 GMCH | 82G45 GMCH | 82G43 GMCH | 82G41 GMCH | 82P45 MCH | 82P43 MCH |
|--------------------------------------------|---------------|---------------|--------------------------|---------------|---------------|---------------|--------------|--------------|
| Platform Technologies | | | | | | | | |
| Intel® AMT | Yes | — | — | — | — | — | — | — |
| Intel® Upgrade Service | — | — | Yes | — | — | — | — | — |
| Standard Manageability | — | Yes | Upgrad e ⁵ | — | — | — | — | — |
| Intel® Remote Wake Technology (Intel® RWT) | — | — | — | Yes | Yes | — | Yes | Yes |
| ASF ⁵ | Yes | Yes | Yes | Yes | Yes | — | Yes | Yes |
| Intel Quiet System Technology ⁵ | Yes | Yes | Yes | Yes | Yes | — | Yes | Yes |
| Intel TPM 1.2 | Yes | Yes | — | — | — | — | — | — |
| Intel VTd | Yes | — | — | — | — | — | — | — |
| Intel TXT | Yes | Yes | — | — | — | — | — | — |

NOTE:

1. "Yes" indicates the feature is supported. "—" indicates the feature is not supported.
2. Support for DIMMs per Channel varies on G43 parts. Please refer to Component Marking Information to identify feature support.
3. Support of ICH7R/HDMI varies on G41 parts. Please refer to Component Marking information to identify feature support.
4. Enabled via Intel® Upgrade Service
5. Enabled via Intel® Upgrade Service offering a "down the wire" Manageability Upgrade consisting of Intel Standard Manageability + CIRA.
6. Intel® Quiet System Technology and ASF functionality requires a correctly configured system, including an appropriate (G)MCH with ME, ME firmware, and system BIOS support.

Figure 1. Intel® Q45, Q43, B43, G45, G43 Chipset System Block Diagram Example

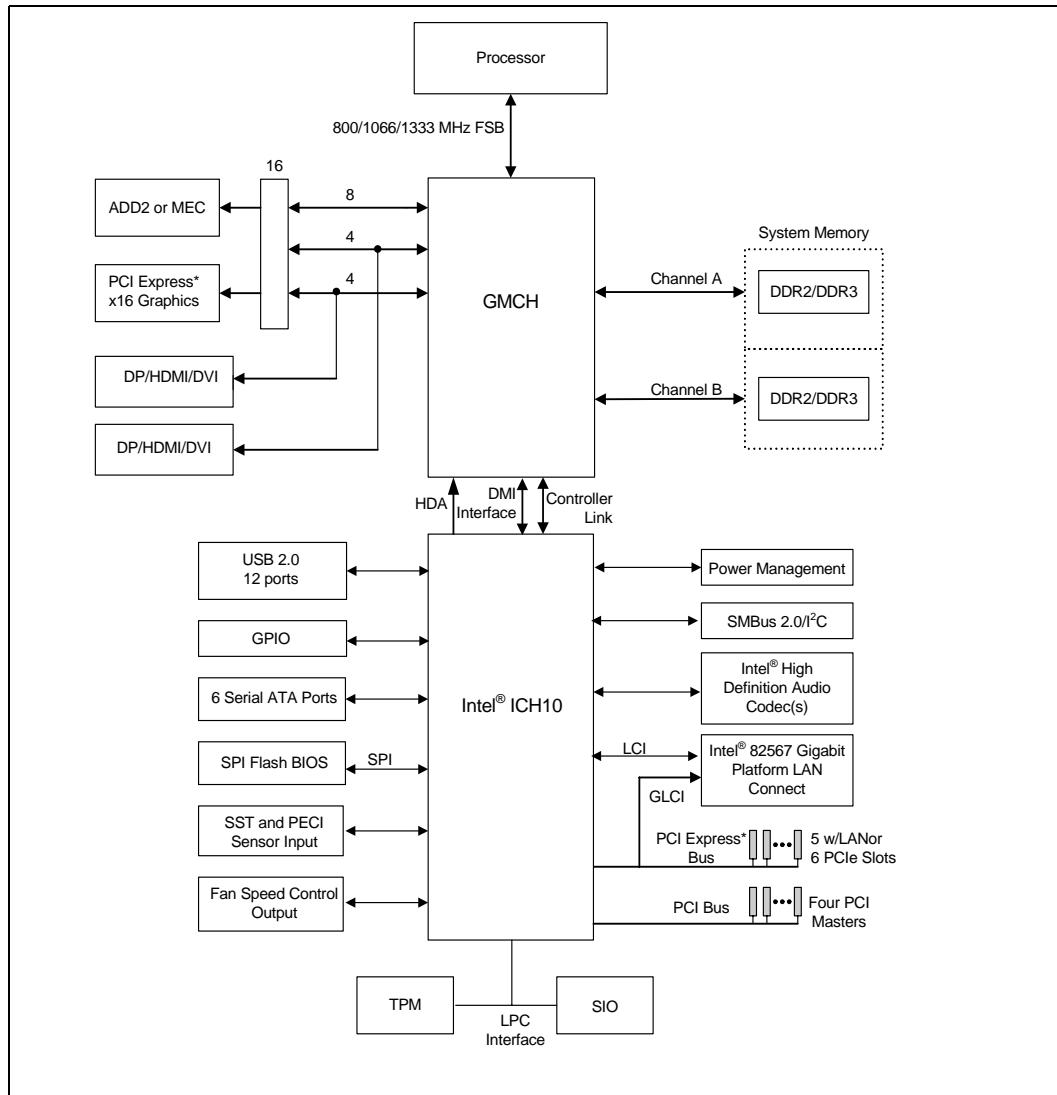



Figure 2. Intel® P45, P43 Chipset System Block Diagram Example

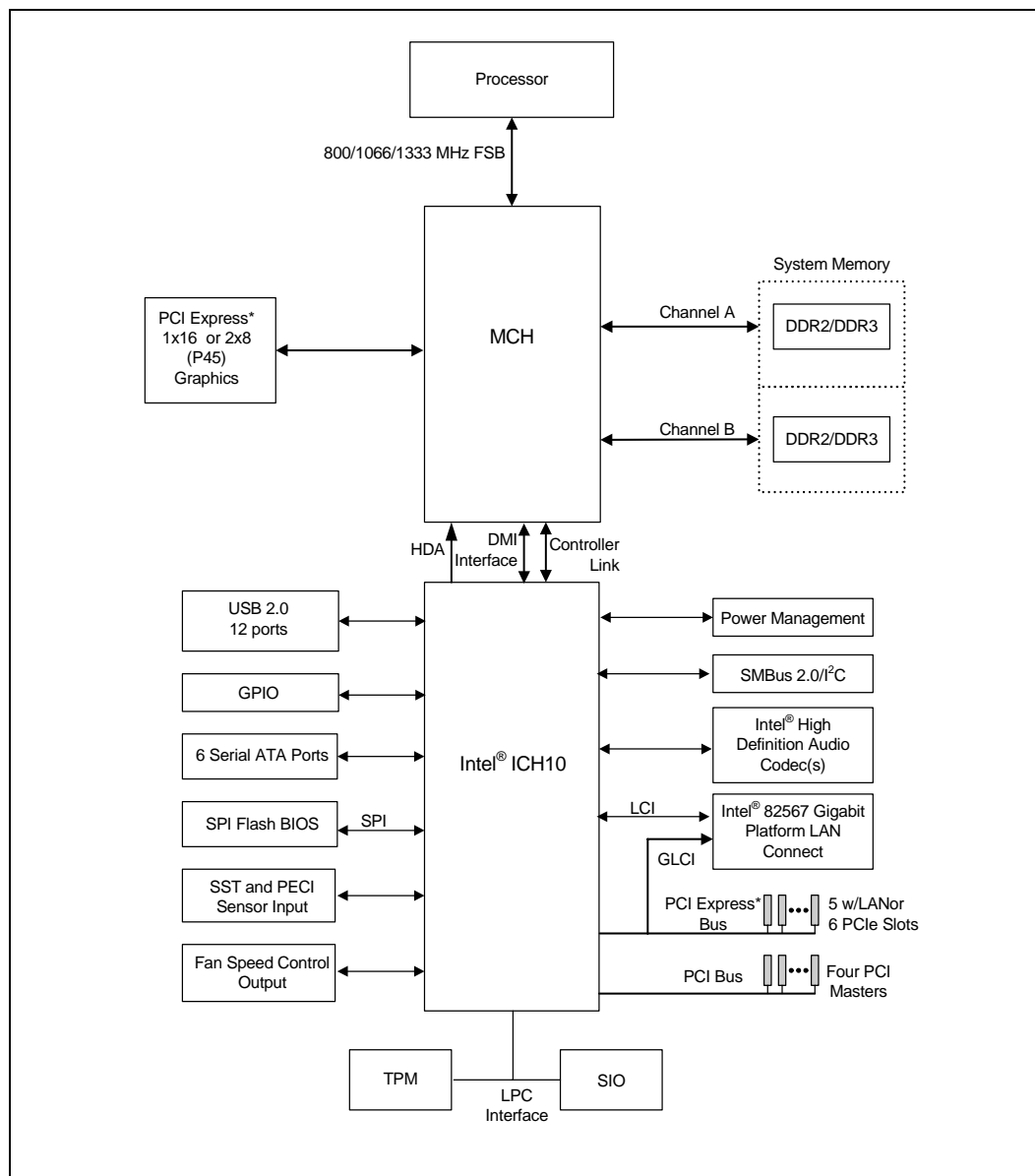
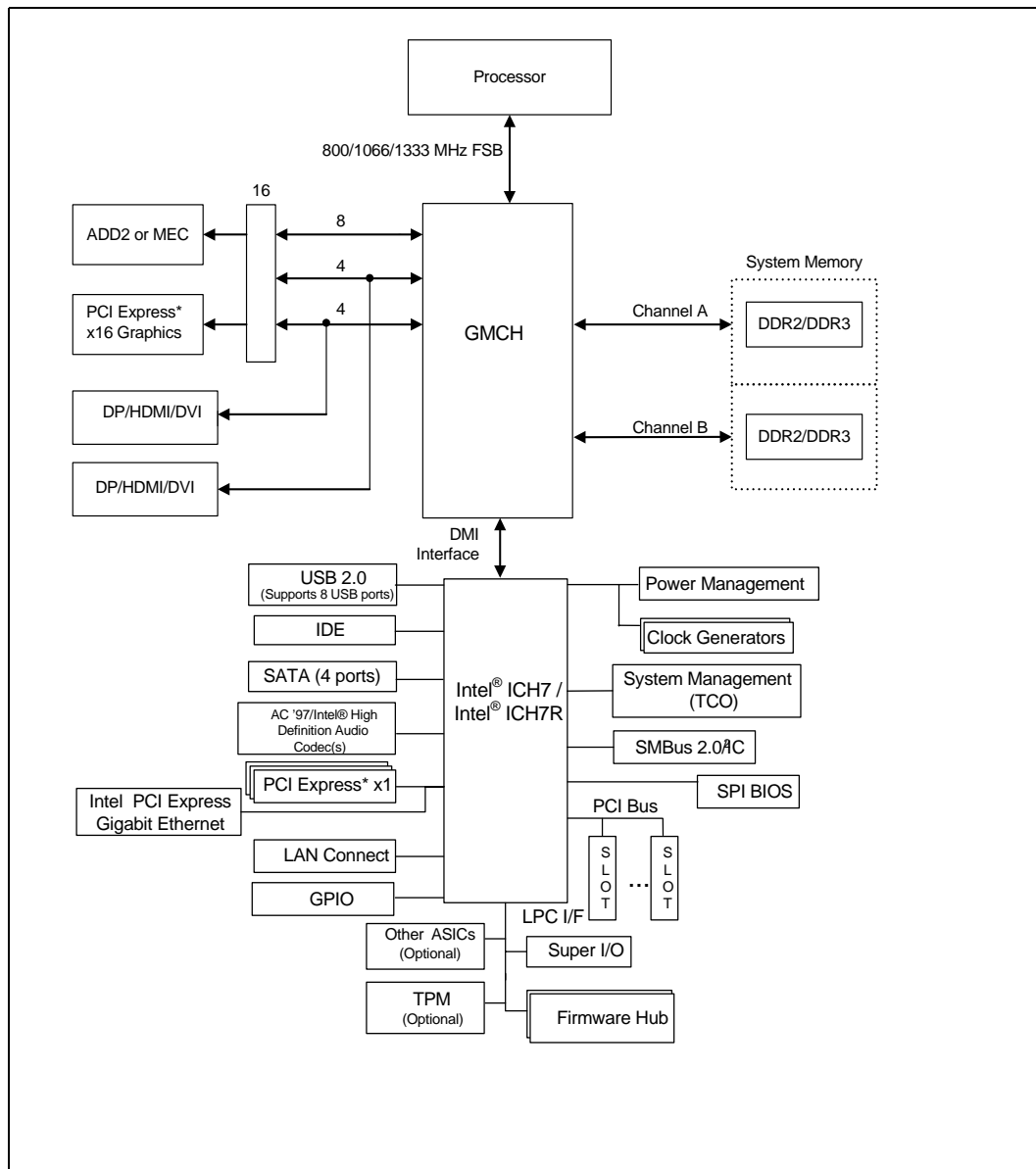

Figure 3. Intel® G41 Express Chipset System Block Diagram Example





1.1 Terminology

| Term | Description |
|--------------------------|------------------------------------------------------------------------------------------------------------------------------------------------------------------------------------------------------------------------------------------------------------------------------------------------------------------------------------------------------------------------------------------------------------------------------------|
| ADD Card | Advanced Digital Display Card. Provides digital display options for an Intel Graphics Controller that supports ADD cards (have DVOs multiplexed with AGP interface). Keyed like an AGP 4x card and plugs into an AGP connector. Will not work with an Intel Graphics Controller that implements Intel® SDVO. |
| ADD2 Card | Advanced Digital Display Card – 2nd Generation. Provides digital display options for an Intel graphics controller that supports ADD2 cards. Plugs into a x16 PCI Express* connector but utilizes the multiplexed SDVO interface. Will not work with an Intel Graphics Controller that supports Intel® DVO and ADD cards. |
| Chipset / Root – Complex | Used in this specification to refer to one or more hardware components that connect processor complexes to the I/O and memory subsystems. The chipset may include a variety of integrated devices. |
| CLink | Controller Link is a proprietary chip-to-chip connection between the (G)MCH and ICH10. The Intel 4 Series Chipset family requires that Clink be connected in the platform. |
| Core | The internal base logic in the (G)MCH |
| CRT | Cathode Ray Tube |
| DBI | Dynamic Bus Inversion |
| DDR2 | A second generation Double Data Rate SDRAM memory technology |
| DDR3 | A third generation Double Data Rate SDRAM memory technology |
| DMI | Direct Media Interface is a proprietary chip-to-chip connection between the (G)MCH and ICH. This interface is based on the standard PCI Express* specification. |
| Domain | A collection of physical, logical or virtual resources that are allocated to work together. Domain is used as a generic term for virtual machines, partitions, etc. |
| DVI | Digital Video Interface. Specification that defines the connector and interface for digital displays. |
| DVMT | Dynamic Video Memory Technology |
| EP | PCI Express Egress Port |
| FSB | Front Side Bus. Synonymous with Host or processor bus |
| Full Reset | Full reset is when PWROK is de-asserted. Warm reset is when both RSTIN# and PWROK are asserted. |
| GMCH | Graphics and Memory Controller Hub component that contains the processor interface, DRAM controller, and PCI Express port. The GMCH contains an integrated graphics device (IGD). The GMCH communicates with the I/O controller hub (Intel® ICH) over the DMI interconnect. |
| MEC | Media Expansion Card. Provides digital display options for an Intel Graphics Controller that supports MEC cards. Plugs into an x16 PCI Express connector but utilizes the multiplexed SDVO interface. Adds Video In capabilities to platform. Will not work with an Intel Graphics Controller that supports DVO and ADD cards. Will function as an ADD2 card in an ADD2 supported system, but Video In capabilities will not work. |
| HDMI | High Definition Multimedia Interface – HDMI supports standard, enhanced, or high-definition video, plus multi-channel digital audio on a single cable. It transmits all ATSC HDTV standards and supports 8-channel digital audio, with bandwidth to spare for future requirements and enhancements (additional details available through http://www.hdmi.org/) |
| Host | This term is used synonymously with processor |

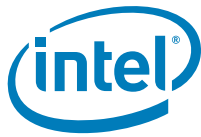

| Term | Description |
|--------------|----------------------------------------------------------------------------------------------------------------------------------------------------------------------------------------------------------------------------------------------------------------------------------------------------------------------------------------------------------------------------------------------------------------------------------------------------------------------------|
| IGD | Internal Graphics Device |
| INTx | An interrupt request signal where X stands for interrupts A, B, C and D |
| Intel® ICH10 | Tenth generation I/O Controller Hub component that contains the primary PCI interface, LPC interface, USB2.0, SATA, and other I/O functions. |
| Intel® ICH7 | Seventh generation I/O Controller Hub component that contains additional functionality compared to previous Intel ICH components. ICH7 contains the primary PCI interface, LPC interface, USB2, SATA, ATA-100, and other I/O functions. It communicates with the (G)MCH over a proprietary interconnect called DMI. For the 82G41 GMCH, the term Intel ICH in this document refers to the ICH7. |
| IOQ | In Order Queue |
| LCD | Liquid Crystal Display |
| LVDS | Low Voltage Differential Signaling. A high speed, low power data transmission standard used for display connections to LCD panels. |
| MCH | Memory Controller Hub component that contains the processor interface, DRAM controller, and PCI Express port. The MCH communicates with the I/O controller hub over the DMI interconnect. |
| MSI | Message Signaled Interrupt. A transaction conveying interrupt information to the receiving agent through the same path that normally carries read and write commands. |
| OOQ | Out of Order Queueing |
| PAVP | Protected Audio-Video Path for supporting secure playback of Intel HD Audio and Video content |
| PCI Express* | A high-speed serial interface whose configuration is software compatible with the legacy PCI specifications. |
| Primary PCI | The physical PCI bus that is driven directly by the ICH10/ICH7 component. Communication between Primary PCI and the (G)MCH occurs over DMI. The Primary PCI bus is not PCI Bus 0 from a configuration standpoint. |
| Processor | Refers to the microprocessor that connects to chipset through the FSB interface on the (G)MCH. |
| Rank | A unit of DRAM corresponding to eight x8 SDRAM devices in parallel or four x16 SDRAM devices in parallel, ignoring ECC. These devices are usually, but not always, mounted on a single side of a DIMM. |
| SCI | System Control Interrupt. Used in ACPI protocol. |
| SDVO | Serial Digital Video Out (SDVO). Digital display channel that serially transmits digital display data to an external SDVO device. The SDVO device accepts this serialized format and then translates the data into the appropriate display format (i.e., TMDS, LVDS, and TV-Out). This interface is not electrically compatible with the previous digital display channel - DVO. The SDVO interface is multiplexed on a portion of the x16 graphics PCI Express interface. |
| SDVO Device | Third party codec that uses SDVO as an input. The device may have a variety of output formats, including DVI, LVDS, HDMI, TV-out, etc. |
| SERR | System Error. An indication that an unrecoverable error has occurred on an I/O bus. |
| SMI | System Management Interrupt. SMI is used to indicate any of several system conditions such as thermal sensor events, throttling activated, access to System Management RAM, chassis open, or other system state related activity. |
| TMDS | Transition Minimized Differential Signaling. Signaling interface from Silicon Image that is used in DVI and HDMI. |



| Term | Description |
|------|------------------------------------------------------------------------------------------|
| TPM | Trusted Platform Module |
| UMA | Unified Memory Architecture. Describes an IGD using system memory for its frame buffers. |
| VCO | Voltage Controlled Oscillator |

Table 2. Intel Specification

| Document Name | Location |
|-------------------------------------------------------------------------------------|-----------------------------------------------------------------------------------------------------------------------------|
| <i>Intel® 4 Series Chipset Family Specification Update</i> | http://www.intel.com/assets/pdf/specupdate/319971.pdf |
| <i>Intel® 4 Series Chipset Family Thermal and Mechanical Design Guide</i> | http://www.intel.com/assets/pdf/designguide/319972.pdf |
| <i>Intel® I/O Controller Hub 10 (ICH10) Family Datasheet</i> | http://www.intel.com/Assets/PDF/datasheet/319973.pdf |
| <i>Intel® I/O Controller Hub 10 (ICH10) Family Thermal Mechanical Design Guide.</i> | http://www.intel.com/assets/pdf/designguide/319975.pdf |
| <i>Intel® I/O Controller Hub 7 (ICH7) Family Datasheet</i> | http://www.intel.com/assets/pdf/datasheet/307013.pdf |
| <i>Intel® I/O Controller Hub 7 (ICH7) Family Thermal Mechanical Design Guide.</i> | http://www.intel.com/assets/pdf/designguide/307015.pdf |
| <i>Advanced Configuration and Power Interface Specification, Version 2.0</i> | http://www.acpi.info/ |
| <i>Advanced Configuration and Power Interface Specification, Version 1.0b</i> | http://www.acpi.info/ |
| <i>The PCI Local Bus Specification, Version 2.3</i> | http://www.pcisig.com/specifications |
| <i>PCI Express* Specification, Version 1.1</i> | http://www.pcisig.com/specifications |



1.2 (G)MCH System Overview

The (G)MCH was designed for use with the Intel® Core™2 Extreme processor QX9000 series, Intel® Core™2 Quad processor Q9000 series, and Intel® Core™2 Duo processor E8000 and E7000 series in the LGA775 Land Grid Array Package targeted for desktop platforms. The role of a (G)MCH in a system is to manage the flow of information between its interfaces: the processor interface, the System Memory interface, the External Graphics or PCI Express interface, internal graphics interfaces, and the I/O Controller through DMI interface. This includes arbitrating between the interfaces when each initiates transactions. It supports one or two channels of DDR2 or DDR3 SDRAM. It also supports PCI Express based external graphics and devices. The Intel 4 Series Chipset platform supports the tenth generation I/O Controller Hub 10 (ICH10) to provide I/O related features. Note that the Intel G41 Chipset supports the I/O Controller Hub 7 (ICH7).

1.2.1 Host Interface

The (G)MCH supports a single LGA775 socket processor. The (G)MCH supports a FSB frequency of 800, 1066, 1333 MHz. Host-initiated I/O cycles are decoded to PCI Express, DMI, or the (G)MCH configuration space. Host-initiated memory cycles are decoded to PCI Express, DMI, or system memory. PCI Express device accesses to non-cacheable system memory are not snooped on the host bus. Memory accesses initiated from PCI Express using PCI semantics and from DMI to system SDRAM will be snooped on the host bus.

Processor/Host Interface (FSB) Details

- Supports Intel® Core™2 Extreme processor QX9000 series, Intel® Core™2 Quad processor Q9000 series, and Intel® Core™2 Duo processor E8000 and E7000 series Family processors
- Supports Front Side Bus (FSB) at the following Frequency Ranges:
 - 800, 1066, 1333 MT/s. FSB speeds are processor dependent.
- Supports FSB Dynamic Bus Inversion (DBI)
- Supports 36-bit host bus addressing, allowing the processor to access the entire 64 GB of the host address space.
- Has a 12-deep In-Order Queue to support up to twelve outstanding pipelined address requests on the host bus
- Has a 1-deep Defer Queue
- Uses GTL+ bus driver with integrated GTL termination resistors
- Supports a Cache Line Size of 64 bytes

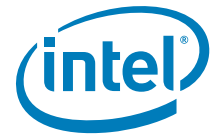

1.2.2 System Memory Interface

The (G)MCH integrates a system memory DDR2/DDR3 controller with two, 64-bit wide interfaces. The buffers support both SSTL_1.8 (Stub Series Terminated Logic for 1.8 V) and SSTL_1.5 (Stub Series Terminated Logic for 1.5V) signal interfaces. The memory controller interface is fully configurable through a set of control registers.

System Memory Interface Details

- Directly supports one or two channels of DDR2 or DDR3 memory with a maximum of two DIMMs per channel.
- Supports single and dual channel memory organization modes.
- Supports a data burst length of eight for all memory organization modes.
- Supported memory data transfer rates:
 - 667 MHz and 800 MHz for DDR2
 - 800 MHz and 1066 MHz for DDR3.
- I/O Voltage of 1.8 V for DDR2 and 1.5 V for DDR3.
- Supports both un-buffered non-ECC DDR2 or non-ECC DDR3 DIMMs.
- Supports maximum memory bandwidth of 6.4 GB/s in single-channel mode or 12.8 GB/s in dual-channel mode assuming DDR2 800 MHz.
- Supports 512-Mb, 1-Gb, 2-Gb DDR2 and 512-Mb, 1-Gb DDR3 DRAM technologies for x8 and x16 devices.
- Using 512 Mb device technologies, the smallest memory capacity possible is 256 MB, assuming Single Channel Mode with a single x16 single sided un-buffered non-ECC DIMM memory configuration.
- Using 2 Gb device technologies, the largest memory capacity possible is 16 GB, assuming Dual Channel Mode with four x8 double sided un-buffered non-ECC or ECC DIMM memory configurations.
NOTE: The ability to support greater than the largest memory capacity is subject to availability of higher density memory devices.
- Supports up to 32 simultaneous open pages per channel (assuming 4 ranks of 8 bank devices)
- Supports opportunistic refresh scheme
- Supports Partial Writes to memory using Data Mask (DM) signals
- Supports a memory thermal management scheme to selectively manage reads and/or writes. Memory thermal management can be triggered either by on-die thermal sensor, or by preset limits. Management limits are determined by weighted sum of various commands that are scheduled on the memory interface.

1.2.3 Direct Media Interface (DMI)

Direct Media Interface (DMI) is the chip-to-chip connection between the (G)MCH and ICH10/ICH7. This high-speed interface integrates advanced priority-based servicing allowing for concurrent traffic and true isochronous transfer capabilities. Base functionality is completely software transparent permitting current and legacy software to operate normally.

To provide for true isochronous transfers and configurable Quality of Service (QoS) transactions, the ICH10/ICH7 supports two virtual channels on DMI: VC0 and VC1. These two channels provide a fixed arbitration scheme where VC1 is always the highest

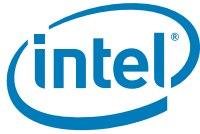

priority. VC0 is the default conduit of traffic for DMI and is always enabled. VC1 must be specifically enabled and configured at both ends of the DMI link (i.e., the ICH10/ICH7 and (G)MCH).

- A chip-to-chip connection interface to Intel ICH10/ICH7
- 2 GB/s point-to-point DMI to ICH10 (1 GB/s each direction)
- 100 MHz reference clock (shared with PCI Express)
- 32-bit downstream addressing
- APIC and MSI interrupt messaging support. Will send Intel-defined "End Of Interrupt" broadcast message when initiated by the processor.
- Message Signaled Interrupt (MSI) messages
- SMI, SCI, and SERR error indication

1.2.4 Multiplexed PCI Express* Graphics Interface and Intel® sDVO/DVI/HDMI/DP Interface

For the 82Q45, 82Q43, 82B43, 82G45, 82G43, and 82G41 GMCHs, the PCI Express Interface is multiplexed with the sDVO and HDMI/DVI interfaces. For the 82P45 and 82P43 MCHs, the PCI Express Interface is not multiplexed.

1.2.4.1 PCI Express* Interface

The (G)MCH supports either two PCI Express* 8-lane (x8) ports or one PCI Express 16-lane (x16) port.

The (G)MCH contains one 16-lane (x16) PCI Express port intended for supporting up to two external PCI Express graphics card in bifurcated mode, fully compliant to the *PCI Express Base Specification, Revision 2.0*.

- Supports PCI Express GEN1 frequency of 1.25 GHz resulting in 2.5 Gb/s each direction (500 MB/s total). Maximum theoretical bandwidth on interface of 4 GB/s in each direction simultaneously, for an aggregate of 8 GB/s when operating in x16 mode.
- Supports PCI Express GEN2 frequency of 2.5 GHz resulting in 5.0 Gb/s each direction (1000 MB/s total). Maximum theoretical bandwidth on interface of 8 GB/s in each direction simultaneously, for an aggregate of 16 GB/s when operating in x16 mode.
- PCI Express port 0 is mapped to PCI Device 1 (PEG).
- PCI Express port 1 is mapped to PCI Device 6 (PEG2).
- Peer to Peer traffic is supported on Virtual Channel 0:
 - From DMI to PEG
 - From DMI to PEG2
 - From PEG to PEG2
 - From PEG2 to PEG
- Supports PCI Express Enhanced Access Mechanism. Allowing accesses to the device configuration space in a flat memory mapped fashion.
- The port may negotiate down to narrower widths. For each of the ports:
 - Support for x16/x8/x4/x1 widths for a single PEG mode.
 - Support for the x8/x4/x1 widths for a dual PEG mode.
 - x1 width support simultaneously with the sDVO functionality which is multiplexed onto the PEG port. Such shared use facilitates ADD2+/MEC implementation.
- The x16 lanes can be configured to two ports in bifurcated mode. In this mode, maximum x8 width is supported.



- The two x8 PCI Express ports can operate in GEN1 or GEN2 mode independent of each other.
- Supports “static” lane numbering reversal.
 - Does not support “dynamic” lane reversal, as defined (optional) by the PCI Express Specification.
- Supports L1 ASPM power management capability.

1.2.4.2 **sDVO Multiplexed Interface (Intel® 82Q45, 82Q43, 82B43, 82G45, 82G43, 82G41 GMCH Only)**

The GMCH supports two multiplexed SDVO ports that each drive pixel clocks up to 270 MHz. The GMCH can make use of these digital display channels via an Advanced Digital Display card (ADD2) or Media Expansion card.

1.2.4.3 **HDMI/DVI/DP Multiplexed Interface (Intel® 82Q45, 82Q43, 82B43, 82G45, 82G43, 82G41 GMCH Only)**

The GMCH supports two multiplexed digital display ports that each drive pixel clocks up to 165 MHz. The GMCH Supports combinations of DP/DP, DVI/DVI, HDMI/HDMI*, DP/DVI, HDMI/DVI, and DP/HDMI multiplexed on the 2 digital display ports.

Note: Only one channel can support embedded audio at a time.

1.2.5 **Graphics Features (Intel® 82Q45, 82Q43, 82B43, 82G45, 82G43, 82G41 GMCH Only)**

The GMCH provides an integrated graphics device (IGD) delivering cost competitive 3D, 2D and video capabilities. DX10 and OpenGL 2.1 are supported. The GMCH contains an extensive set of instructions for 3D operations, 2D operations, motion compensation, overlay, and display control. HD-DVD and Blu-Ray are also natively supported with hardware based VC-1, MPEG2, and AVC decode capabilities. The GMCH also supports PAVP (Protected Audio-Video Path), which allows for protected Intel® HD Audio HD Video Playback.

The GMCH uses a UMA configuration with DVMT for graphics memory. The GMCH also has the capability to support external graphics accelerators via the PCI Express Graphics (PEG) port but cannot work concurrently with the integrated graphics device. High bandwidth access to data is provided through the system memory port.

1.2.6 **(G)MCH Clocking**

- Differential host clock of 200/266/333 MHz. The (G)MCH supports FSB transfer rates of 800/1066/1333 MT/s.
- Differential memory clocks of 333/400/533/600 MHz. The (G)MCH supports memory transfer rates of DDR2-667, DDR2-800, DDR3-800, and DDR3-1067.
- The PCI Express* PLL of 100 MHz Serial Reference Clock generates the PCI Express core clock of 250 MHz.
- Display timings are generated from display PLLs that use a 96 MHz differential non-spread spectrum clock as a reference. Display PLLs can also use the sSDVO_TVCLKIN[+/-] from an SDVO device as a reference. (82Q45, 82Q43, 82B43, 82G45, 82G43, and 82G41 GMCH only)
- All of the above clocks are capable of tolerating Spread Spectrum clocking.
- Host, memory, and PCI Express PLLs are disabled until PWROK is asserted.

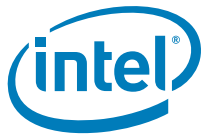

1.2.7 Power Management

(G)MCH Power Management support includes:

- PC99 suspend to DRAM support (“STR”, mapped to ACPI state S3)
- SMRAM space remapping to A0000h (128 KB)
- Supports extended SMRAM space above 256 MB, additional 1 MB TSEG from the Base of graphics stolen memory (BSM) when enabled, and cacheable (cacheability controlled by processor)
- ACPI Rev 3.0b compatible power management
- Supports Active State Power Management (ASPM)
- Supports processor states: C0, C1, C2, C3, and C4
- Supports System states: S0, S1, S3, and S5
- Supports processor Thermal Management 2 (TM2)
- Supports Manageability states M0, M1–S3, M1–S5, M0ff–S3, M0ff–S5, M0ff-M1

1.2.8 Thermal Sensor

(G)MCH Thermal Sensor support includes:

- Catastrophic Trip Point support for emergency clock gating for the (G)MCH
- Hot Trip Point support for SMI generation

§ §



2 Signal Description

This chapter provides a detailed description of (G)MCH signals. The signals are arranged in functional groups according to their associated interface.

The following notations are used to describe the signal type.

| Signal Type | Description |
|--------------|------------------------------------------------------------------------------------------------------------------------------------------------------------------------------------------------------------------------------------------------------------------------------------------------------------------|
| PCI Express* | PCI Express interface signals. These signals are compatible with PCI Express 2.0 Signaling Environment AC Specifications and are AC coupled. The buffers are not 3.3 V tolerant. Differential voltage spec = $(D+ - D-) * 2 = 1.2 \text{ Vmax}$. Single-ended maximum = 1.25 V. Single-ended minimum = 0 V. |
| DMI | Direct Media Interface signals. These signals are compatible with PCI Express 2.0 Signaling Environment AC Specifications, but are DC coupled. The buffers are not 3.3 V tolerant. Differential voltage spec = $(D+ - D-) * 2 = 1.2 \text{ Vmax}$. Single-ended maximum = 1.25 V. Single-ended minimum = 0 V. |
| CMOS | CMOS buffers. 1.5 V tolerant. |
| COD | CMOS Open Drain buffers. 3.3 V tolerant. |
| HVCMOS | High Voltage CMOS buffers. 3.3 V tolerant. |
| HVIN | High Voltage CMOS input-only buffers. 3.3 V tolerant. |
| SSTL_1.8 | Stub Series Termination Logic. These are 1.8 V output capable buffers. 1.8 V tolerant. |
| SSTL_1.5 | Stub Series Termination Logic. These are 1.5 V output capable buffers. 1.5 V tolerant. |
| A | Analog reference or output. May be used as a threshold voltage or for buffer compensation. |
| GTL+ | Gunning Transceiver Logic signaling technology. Implements a voltage level as defined by V_{TT} of 1.2 V and/or 1.1 V. |



2.1 Host Interface Signals

Note: Unless otherwise noted, the voltage level for all signals in this interface is tied to the termination voltage of the Host Bus (V_{TT}).

| Signal Name | Type | Description |
|-----------------|----------------|--------------------------------------------------------------------------------------------------------------------------------------------------------------------------------------------------------------------------------------------------------------------------------------------------------------------------------------------------------------------------------------------------------------------------------------------------------|
| FSB_ADSB | I/O GTL+ | Address Strobe: The processor bus owner asserts FSB_ADSB to indicate the first of two cycles of a request phase. The (G)MCH can assert this signal for snoop cycles and interrupt messages. |
| FSB_BNRB | I/O GTL+ | Block Next Request: Used to block the current request bus owner from issuing new requests. This signal is used to dynamically control the processor bus pipeline depth. |
| FSB_BPRIB | O GTL+ | Priority Agent Bus Request: The (G)MCH is the only Priority Agent on the processor bus. It asserts this signal to obtain the ownership of the address bus. This signal has priority over symmetric bus requests and will cause the current symmetric owner to stop issuing new transactions unless the FSB_LOCKB signal was asserted. |
| FSB_BREQOB | O GTL+ | Bus Request 0: The (G)MCH pulls the processor bus' FSB_BREQOB signal low during FSB_CPURSTB. The processors sample this signal on the active-to-inactive transition of FSB_CPURSTB. The minimum setup time for this signal is 4 HCLKs. The minimum hold time is 2 HCLKs and the maximum hold time is 20 HCLKs. FSB_BREQOB should be tri-stated after the hold time requirement has been satisfied. |
| FSB_CPURSTB | O GTL+ | CPU Reset: The FSB_CPURSTB pin is an output from the (G)MCH. The (G)MCH asserts FSB_CPURSTB while RSTINB (PCIRST# from the ICH) is asserted and for approximately 1 ms after RSTINB is de-asserted. The FSB_CPURSTB allows the processor to begin execution in a known state. |
| FSB_DBSYB | I/O GTL+ | Data Bus Busy: Used by the data bus owner to hold the data bus for transfers requiring more than one cycle. |
| FSB_DEFERB | O GTL+ | Defer: Signals that the (G)MCH will terminate the transaction currently being snooped with either a deferred response or with a retry response. |
| FSB_DINVB_[3:0] | I/O GTL+ 4x | Dynamic Bus Inversion: Driven along with the FSB_DB_[63:0] signals. Indicates if the associated signals are inverted or not. FSB_DINVB_[3:0] are asserted such that the number of data bits driven electrically low (low voltage) within the corresponding 16 bit group never exceeds 8. FSB_DINVB_x Data Bits FSB_DINVB_3 FSB_DB_[63:48] FSB_DINVB_2 FSB_DB_[47:32] FSB_DINVB_1 FSB_DB_[31:16] FSB_DINVB_0 FSB_DB_[15:0] |
| FSB_DRDYB | I/O GTL+ | Data Ready: Asserted for each cycle that data is transferred. |



| Signal Name | Type | Description |
|--------------------------------------|-------------------|---------------------------------------------------------------------------------------------------------------------------------------------------------------------------------------------------------------------------------------------------------------------------------------------------------------------------------------------------------------------------------------------------------------------------------------------------------------------------------------------------------------------------------------------------------------------------------------|
| FSB_AB_[35:3] | I/O GTL+ 2x | Host Address Bus: FSB_AB_[35:3] connect to the processor address bus. During processor cycles the FSB_AB_[35:3] are inputs. The (G)MCH drives FSB_AB_[35:3] during snoop cycles on behalf of DMI and PCI Express initiators. FSB_AB_[35:3] are transferred at 2x rate. Note that the address is inverted on the processor bus. The values are driven by the (G)MCH between PWROK assertion and FSB_CPURSTINB deassertion to allow processor configuration. |
| FSB_ADSTBB_[1:0] | I/O GTL+ 2x | Host Address Strobe: The source synchronous strobes used to transfer FSB_AB_[31:3] and FSB_REQB_[4:0] at the 2x transfer rate. Strobe Address Bits FSB_ADSTBB_0 FSB_AB_[16:3], FSB_REQB_[4:0] FSB_ADSTBB_1 FSB_AB_[31:17] |
| FSB_DB_[63:0] | I/O GTL+ 4x | Host Data: These signals are connected to the processor data bus. Data on FSB_DB_[63:0] is transferred at a 4x rate. Note that the data signals may be inverted on the processor bus, depending on the FSB_DINVB_[3:0] signals. |
| FSB_DSTBPB_[3:0] FSB_DSTBNB_[3:0] | I/O GTL+ 4x | Differential Host Data Strobes: The differential source synchronous strobes used to transfer FSB_DB_[63:0] and FSB_DINVB_[3:0] at the 4x transfer rate. Named this way because they are not level sensitive. Data is captured on the falling edge of both strobes. Hence, they are pseudo-differential, and not true differential. Strobe Data Bits FSB_DSTB[P,N]B_3 FSB_DB_[63:48], HDINVB_3 FSB_DSTB[P,N]B_2 FSB_DB_[47:32], HDINVB_2 FSB_DSTB[P,N]B_1 FSB_DB_[31:16], HDINVB_1 FSB_DSTB[P,N]B_0 FSB_DB_[15:0], HDINVB_0 |
| FSB_HITB | I/O GTL+ | Hit: Indicates that a caching agent holds an unmodified version of the requested line. Also, driven in conjunction with FSB_HITMB by the target to extend the snoop window. |
| FSB_HITMB | I/O GTL+ | Hit Modified: Indicates that a caching agent holds a modified version of the requested line and that this agent assumes responsibility for providing the line. Also, driven in conjunction with FSB_HITB to extend the snoop window. |
| FSB_LOCKB | I GTL+ | Host Lock: All processor bus cycles sampled with the assertion of FSB_LOCKB and FSB_ADSB, until the negation of FSB_LOCKB must be atomic, i.e. <i>no DMI or PCI Express access</i> to DRAM are allowed when FSB_LOCKB is asserted by the processor. |
| FSB_REQB_[4:0] | I/O GTL+ 2x | Host Request Command: Defines the attributes of the request. FSB_REQB_[4:0] are transferred at 2x rate. Asserted by the requesting agent during both halves of Request Phase. In the first half the signals define the transaction type to a level of detail that is sufficient to begin a snoop request. In the second half the signals carry additional information to define the complete transaction type. The transactions supported by the (G)MCH Host Bridge are defined in the Host Interface section of this document. |



| Signal Name | Type | Description | | | | | | | | | | | | | | | | | | |
|---------------|--------------------------------------------|-----------------------------------------------------------------------------------------------------------------------------------------------------------------------------------------------------------------------------------------------------------------------------------------------------------------------------------------------------------------------------------------------------------------------------------------------------------------------------------------------------------------------------------------------------------------------------------------------------------------------------------------------------------------------------|----------|---------------|-----|------------|-----|----------------|-----|-------------------|-----|----------------------------------------|-----|--------------------------------------------|-----|------------------|-----|--------------------|-----|----------------------|
| FSB_TRDYB | O GTL+ | Host Target Ready: Indicates that the target of the processor transaction is able to enter the data transfer phase. | | | | | | | | | | | | | | | | | | |
| FSB_RSB_[2:0] | O GTL+ | <p>Response Signals: Indicates type of response according to the table at left:</p> <table border="1"> <thead> <tr> <th>Encoding</th> <th>Response Type</th> </tr> </thead> <tbody> <tr> <td>000</td> <td>Idle state</td> </tr> <tr> <td>001</td> <td>Retry response</td> </tr> <tr> <td>010</td> <td>Deferred response</td> </tr> <tr> <td>011</td> <td><i>Reserved (not driven by (G)MCH)</i></td> </tr> <tr> <td>100</td> <td><i>Hard Failure (not driven by (G)MCH)</i></td> </tr> <tr> <td>101</td> <td>No data response</td> </tr> <tr> <td>110</td> <td>Implicit Writeback</td> </tr> <tr> <td>111</td> <td>Normal data response</td> </tr> </tbody> </table> | Encoding | Response Type | 000 | Idle state | 001 | Retry response | 010 | Deferred response | 011 | <i>Reserved (not driven by (G)MCH)</i> | 100 | <i>Hard Failure (not driven by (G)MCH)</i> | 101 | No data response | 110 | Implicit Writeback | 111 | Normal data response |
| Encoding | Response Type | | | | | | | | | | | | | | | | | | | |
| 000 | Idle state | | | | | | | | | | | | | | | | | | | |
| 001 | Retry response | | | | | | | | | | | | | | | | | | | |
| 010 | Deferred response | | | | | | | | | | | | | | | | | | | |
| 011 | <i>Reserved (not driven by (G)MCH)</i> | | | | | | | | | | | | | | | | | | | |
| 100 | <i>Hard Failure (not driven by (G)MCH)</i> | | | | | | | | | | | | | | | | | | | |
| 101 | No data response | | | | | | | | | | | | | | | | | | | |
| 110 | Implicit Writeback | | | | | | | | | | | | | | | | | | | |
| 111 | Normal data response | | | | | | | | | | | | | | | | | | | |
| FSB_RCOMP | I/O A | Host RCOMP: Used to calibrate the Host GTL+ I/O buffers. This signal is powered by the Host Interface termination rail (V_{TT}). Connects to FSB_XRCOMP11N in the package. | | | | | | | | | | | | | | | | | | |
| FSB_SCOMP | I/O A | Slew Rate Compensation: Compensation for the Host Interface for rising edges. | | | | | | | | | | | | | | | | | | |
| FSB_SCOMPB | I/O A | Slew Rate Compensation: Compensation for the Host Interface for falling edges. | | | | | | | | | | | | | | | | | | |
| FSB_SWING | I/O A | Host Voltage Swing: These signals provide reference voltages used by the FSB RCOMP circuits. FSB_XSWING is used for the signals handled by FSB_XRCOMP. | | | | | | | | | | | | | | | | | | |
| FSB_DVREF | I/O A | Host Reference Voltage: Reference voltage input for the Data signals of the Host GTL interface. | | | | | | | | | | | | | | | | | | |
| FSB_ACCVREF | I/O A | Host Reference Voltage: Reference voltage input for the Address signals of the Host GTL interface. | | | | | | | | | | | | | | | | | | |



2.2 System Memory (DDR2/DDR3) Interface Signals

2.2.1 System Memory Channel A Interface Signals

| Signal Name | Type | Description |
|------------------|---------------------|---------------------------------------------------------------------------------------------------------------------------------------------------|
| DDR_A_CK | O SSTL-1.8/1.5 | SDRAM Differential Clocks: <ul style="list-style-type: none"> • DDR2: Three per DIMM • DDR3: Two per DIMM |
| DDR_A_CKB | O SSTL-1.8/1.5 | SDRAM Inverted Differential Clocks: <ul style="list-style-type: none"> • DDR2: Three per DIMM • DDR3: Two per DIMM |
| DDR_A_CSB_[3:0] | O SSTL-1.8/1.5 | DDR2/DDR3 Device Rank 3, 2, and 0 Chip Selects |
| DDR_A_CKE_[3:0] | O SSTL-1.8/1.5 | DDR2/DDR3 Clock Enable: (1 per Device Rank) |
| DDR_A_ODT_[3:0] | O SSTL-1.8/1.5 | DDR2/DDR3 On Die Termination: (1 per Device Rank) |
| DDR_A_MA_[14:0] | O SSTL-1.8/1.5 | DDR2 Address Signals [14:0] |
| DDR_A_BS_[2:0] | O SSTL-1.8/1.5 | DDR2/DDR3 Bank Select |
| DDR_A_RASB | O SSTL-1.8/1.5 | DDR2/DDR3 Row Address Select signal |
| DDR_A_CASB | O SSTL-1.8/1.5 | DDR2/DDR3 Column Address Select signal |
| DDR_A_WEB | O SSTL-1.8/1.5 | DDR2/DDR3 Write Enable signal |
| DDR_A_DQ_[63:0] | I/O SSTL-1.8/1.5 | DDR2/DDR3 Data Lines |
| DDR_A_DM_[7:0] | O SSTL-1.8/1.5 | DDR2/DDR3 Data Mask |
| DDR_A_DQS_[7:0] | I/O SSTL-1.8/1.5 | DDR2/DDR3 Data Stobes |
| DDR_A_DQSB_[7:0] | I/O SSTL-1.8/1.5 | DDR2/DDR3 Data Strobe Complements |



2.2.2 System Memory Channel B Interface Signals

| Signal Name | Type | Description |
|------------------|---------------------|---------------------------------------------------------------------------------------------------------------------------------------------------|
| DDR_B_CK | O SSTL-1.8/1.5 | SDRAM Differential Clocks: <ul style="list-style-type: none"> • DDR2: Three per DIMM • DDR3: Two per DIMM |
| DDR_B_CKB | O SSTL-1.8/1.5 | SDRAM Inverted Differential Clocks: <ul style="list-style-type: none"> • DDR2: Three per DIMM • DDR3: Two per DIMM |
| DDR_B_CSB_[3:0] | O SSTL-1.8/1.5 | DDR2/DDR3 Device Rank 3, 2, 1, and 0 Chip Select |
| DDR_B_CKE_[3:0] | O SSTL-1.8/1.5 | DDR2/DDR3 Clock Enable: (1 per Device Rank) |
| DDR_B_ODT_[3:0] | O SSTL-1.8/1.5 | DDR2/DDR3 Device Rank 3, 2, 1, and 0 On Die Termination |
| DDR_B_MA_[14:0] | O SSTL-1.8/1.5 | DDR2/DDR3 Address Signals [14:0] |
| DDR_B_BS_[2:0] | O SSTL-1.8/1.5 | DDR2/DDR3 Bank Select |
| DDR_B_RASB | O SSTL-1.8/1.5 | DDR2/DDR3 Row Address Select signal |
| DDR_B_CASB | O SSTL-1.8/1.5 | DDR2/DDR3 Column Address Select signal |
| DDR_B_WEB | O SSTL-1.8/1.5 | DDR2/DDR3 Write Enable signal |
| DDR_B_DQ_[63:0] | I/O SSTL-1.8/1.5 | DDR2/DDR3 Data Lines |
| DDR_B_DM_[7:0] | O SSTL-1.8/1.5 | DDR2/DDR3 Data Mask |
| DDR_B_DQS_[7:0] | I/O SSTL-1.8/1.5 | DDR2/DDR3 Data Strobes |
| DDR_B_DQSB_[7:0] | I/O SSTL-1.8/1.5 | DDR2/DDR3 Data Strobe Complements |



2.2.3 System Memory Miscellaneous Signals

| Signal Name | Type | Description |
|-----------------|-------------------|---------------------------------|
| DDR_RPD | I/O A | System Memory Pull-down RCOMP |
| DDR_RPU | I/O A | System Memory Pull-up RCOMP |
| DDR_SPD | I/O A | System Memory Pull-down RCOMP |
| DDR_SPU | I/O A | System Memory Pull-up RCOMP |
| DDR_VREF | I A | System Memory Reference Voltage |
| DDR3_DRAM_PWROK | I A | DDR3 VCC_DDR Power OK |
| DDR3_DRAMRSTB | O SSTL-1.5 | DDR3 Reset Signal |
| DDR3_A_CSB1 | O SSTL-1.8/1.5 | DDR3 CSB1 Signal |
| DDR3_A_MA0 | O SSTL-1.8/1.5 | DDR3 MA0 Signal |
| DDR3_A_WEB | O SSTL-1.8/1.5 | DDR3 WEB Signal |
| DDR3_B_ODT3 | O SSTL-1.8/1.5 | DDR3 ODT3 Signal |

2.3 PCI Express* Interface Signals

| Signal Name | Type | Description |
|----------------------------------|-------------|-------------------------------------------------|
| PEG_RXN_[15:0] PEG_RXP_[15:0] | I/O PCIE | Primary PCI Express Receive Differential Pair |
| PEG_TXN_[15:0] PEG_TXP_[15:0] | O PCIE | Primary PCI Express Transmit Differential Pair |
| EXP_ICOMPO | I A | Primary PCI Express Output Current Compensation |
| EXP_COMPI | I A | Primary PCI Express Input Current Compensation |
| EXP_RCOMPO | I A | Primary PCI Express Resistive Compensation |
| EXP_RBIAIS | I A | Primary PCI Express Bias |

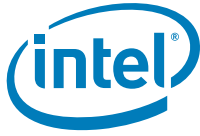

2.4 Controller Link Interface Signals

| Signal Name | Type | Description |
|-------------|-------------|-----------------------------------------------|
| CL_DATA | I/O CMOS | Controller Link Data (Bi-directional) |
| CL_CLK | I/O CMOS | Controller Link Clock (Bi-directional) |
| CL_VREF | I CMOS | Controller Link VREF |
| CL_RST# | I CMOS | Controller Link Reset (Active low) |

2.5 Analog Display Signals (Intel® 82Q45, 82Q43, 82B43, 82G45, 82G43, 82G41 GMCH Only)

| Signal Name | Type | Description |
|--------------|-------------|--------------------------------------------------------------------------------------------------------------------------------------------------------------------------------------------------------------------------------------------------------------------------------------------------------|
| CRT_RED | O A | RED Analog Video Output: This signal is a CRT Analog video output from the internal color palette DAC. The DAC is designed for a 37.5 ohm routing impedance but the terminating resistor to ground will be 75 ohms. (e.g., 75 ohm resistor on the board, in parallel with a 75 ohm CRT load). |
| CRT_GREEN | O A | GREEN Analog Video Output: This signal is a CRT Analog video output from the internal color palette DAC. The DAC is designed for a 37.5 ohm routing impedance but the terminating resistor to ground will be 75 ohms. (e.g., 75 ohm resistor on the board, in parallel with a 75 ohm CRT load). |
| CRT_BLUE | O A | BLUE Analog Video Output: This signal is a CRT Analog video output from the internal color palette DAC. The DAC is designed for a 37.5 ohm routing impedance but the terminating resistor to ground will be 75 ohms. (e.g., 75 ohm resistor on the board, in parallel with a 75 ohm CRT load). |
| CRT_IREF | I/O A | Resistor Set: Set point resistor for the internal color palette DAC. A 255 ohm 1% resistor is required between CRT_IREF and motherboard ground. |
| CRT_HSYNC | O HVCMOS | CRT Horizontal Synchronization: This signal is used as the horizontal sync (polarity is programmable) or "sync interval". 2.5 V output. |
| CRT_VSYNC | O HVCMOS | CRT Vertical Synchronization: This signal is used as the vertical sync (polarity is programmable). 2.5 V output. |
| CRT_DDC_CLK | I/O COD | Monitor Control Clock |
| CRT_DDC_DATA | I/O COD | Monitor Control Data |
| CRT_IRTN | I/O COD | Monitor Interrupt Return |



2.6 Clocks, Reset, and Miscellaneous

| Signal Name | Type | Description |
|------------------------------------|--------------|-------------------------------------------------------------------------------------------------------------------------------------------------------------------------------------------------------------------------------------------------------------------------------------------------------------------------------------------------------------------------------------------------------------------|
| HPL_CLKINP HPL_CLKINN | I CMOS | Differential Host Clock In: These pins receive a differential host clock from the external clock synthesizer. This clock is used by all of the (G)MCH logic that is in the Host clock domain. |
| EXP_CLKP EXP_CLKN | I CMOS | Differential Primary PCI Express Clock In: These pins receive a differential 100 MHz Serial Reference clock from the external clock synthesizer. This clock is used to generate the clocks necessary for the support of Primary PCI Express and DMI. |
| DPL_REFCLKINN DPL_REFCLKINP | I CMOS | Display PLL Differential Clock In: Tie DPL_REFCLKINP to V _{CC} and tie DPL_REFCLKINN to ground when not using DP. |
| DPL_REFSSCLKINP DPL_REFSSCLKINN | I CMOS | Display PLL Differential Clock In: Tie DPL_REFSSCLKINP to V _{CC} and tie DPL_REFSSCLKINN to ground when not using DP. |
| RSTINB | I SSTL | Reset In: When asserted, this signal will asynchronously reset the (G)MCH logic. This signal is connected to the PCIRST# output of the ICH. All PCI Express output signals and DMI output signals will also tri-state compliant to <i>PCI Express Specification, Revision 2.0</i> . This input should have a Schmitt trigger to avoid spurious resets. This signal is required to be 3.3 V tolerant. |
| CL_PWROK | I/O SSTL | CL Power OK: When asserted, CL_PWROK is an indication to the (G)MCH that core power (VCC_CL) has been stable for at least 10 us. |
| EXP_SLR | I CMOS | PCI Express* Static Lane Reversal/Form Factor Selection: (G)MCH's PCI Express lane numbers are reversed to differentiate Balanced Technology Extended (BTX) and ATX form factors. 0 = (G)MCH PCI Express lane numbers are reversed (BTX) 1 = Normal operation (ATX) |
| BSEL[2:0] | I CMOS | Bus Speed Select: At the de-assertion of PWROK, the value sampled on these pins determines the expected frequency of the bus. |
| EXP_SM | I GTL+ | Concurrent PCI Express Port Enable: Concurrent SDVO and PCI Express 0 = Only SDVO or PCI Express is operational. 1 = Both SDVO and PCI Express are operating simultaneously via the PCI Express port. NOTE: For the 82P45 and 82P42 MCH, this signal should be pulled low. |
| PWROK | I/O SSTL | Power OK: When asserted, PWROK is an indication to the (G)MCH that core power has been stable for at least 10 us. |
| DPRSTPB | O HVC MOS | Advanced Power Management Signal |



| Signal Name | Type | Description |
|---------------|--------------|----------------------------------------------------------------------------------------------------------------------------------------------------------------------------------|
| SLPB | O HVC MOS | Advanced Power Management Signal |
| ICH_SYNCB | O HVC MOS | ICH Sync Signal |
| ALLZTEST | I GTL+ | All Z Test: This signal is used for Chipset Bed of Nails testing to execute All Z Test. It is used as output for XOR Chain testing. |
| XORTEST | I GTL+ | XOR Chain Test: This signal is used for Chipset Bed of Nails testing to execute XOR Chain Test. |
| CEN | I GTL+ | TLS Confidentiality Enable: 0 = Disable TLS 1 = Enable TLS |
| ITPM_ENB | I GTL+ | Integrated TPM Enable: 0 = Enable Intel TPM 1 = Disable Intel TPM NOTE: This signal is not used on the 82G45, 82G43, 82G41 GMCH and 82P45, 82P43 MCH. |
| DualX8_Enable | I GTL+ | 2x8 PEG Port Bifurcation: 0 = 2x8 PCI Express Ports Enabled 1 = 1x16 PCI Express Port Enabled |
| BSCANTEST | I GTL+ | Boundary Scan Test Enable: This signal is used to enter Boundary Scan mode |
| JTAG_TCK | I/O SSTL | JTAG Clock |
| JTAG_TDI | I/O SSTL | JTAG Data In |
| JTAG_TDO | I/O SSTL | JTAG Data Out |
| JTAG_TMS | I/O SSTL | JTAG Test Mode Select |

2.7 Direct Media Interface

| Signal Name | Type | Description |
|--------------------------------|----------|-----------------------------------------------------------------------------------------------------|
| DMI_RXP_[3:0] DMI_RXN_[3:0] | I DMI | Direct Media Interface: Receive differential pair (RX). (G)MCH-ICH serial interface input. |
| DMI_TXP_[3:0] DMI_TXN_[3:0] | O DMI | Direct Media Interface: Transmit differential pair (TX). (G)MCH-ICH serial interface output. |



2.8 Serial DVO Interface (Intel[®] 82Q45, 82Q43, 82B43, 82G45, 82G43, 82G41 GMCH Only)

Most of these signals are multiplexed with PCI Express signals. SDVO_CTTCLK and SDVO_CTRLDATA are the only unmultiplexed signals on the SDVO interface. SDVO is mapped to lanes 0–7 or lanes 15–8 of the PEG port depending on the PCI Express Static Lane Reversal and SDVO/PCI Express Coexistence straps. The lower 8 lanes are used when **both** straps are either asserted or not asserted. Otherwise, the upper 8 lanes are used.

| Signal Name | Type | Description |
|--------------|-----------|-----------------------------------------------------------|
| SDVOB_CLK- | ○ PCIE | Serial Digital Video Channel B Clock Complement |
| SDVOB_CLK+ | ○ PCIE | Serial Digital Video Channel B Clock |
| SDVOB_RED- | ○ PCIE | Serial Digital Video Channel C Red Complement |
| SDVOB_RED+ | ○ PCIE | Serial Digital Video Channel C Red |
| SDVOB_GREEN- | ○ PCIE | Serial Digital Video Channel B Green Complement |
| SDVOB_GREEN+ | ○ PCIE | Serial Digital Video Channel B Green |
| SDVOB_BLUE- | ○ PCIE | Serial Digital Video Channel B Blue Complement |
| SDVOB_BLUE+ | ○ PCIE | Serial Digital Video Channel B Blue |
| SDVOC_RED- | ○ PCIE | Serial Digital Video Channel C Red Complement |
| SDVOC_RED+ | ○ PCIE | Serial Digital Video Channel C Red Channel B Alpha |
| SDVOC_GREEN- | ○ PCIE | Serial Digital Video Channel C Green Complement |
| SDVOC_GREEN+ | ○ PCIE | Serial Digital Video Channel C Green |
| SDVOC_BLUE- | ○ PCIE | Serial Digital Video Channel C Blue Complement |
| SDVOC_BLUE+ | ○ PCIE | Serial Digital Video Channel C Blue |
| SDVOC_CLK- | ○ PCIE | Serial Digital Video Channel C Clock Complement |
| SDVOC_CLK+ | ○ PCIE | Serial Digital Video Channel C Clock |

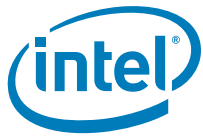

| Signal Name | Type | Description |
|---------------|------------|--------------------------------------------------------------------|
| SDVO_TVCLKIN- | I PCIE | Serial Digital Video TVOUT Synchronization Clock Complement |
| SDVO_TVCLKIN | I PCIE | Serial Digital Video TVOUT Synchronization Clock |
| SDVOB_INT- | I PCIE | Serial Digital Video Input Interrupt Complement |
| SDVOB_INT+ | I PCIE | Serial Digital Video Input Interrupt |
| SDVOC_INT- | I PCIE | Serial Digital Video Input Interrupt Complement |
| SDVOC_INT+ | I PCIE | Serial Digital Video Input Interrupt |
| SDVO_STALL- | I PCIE | Serial Digital Video Field Stall Complement |
| SDVO_STALL+ | I PCIE | Serial Digital Video Field Stall |
| SDVO_CTRLCLK | I/O COD | Serial Digital Video Device Control Clock |
| SDVO_CTRLDATA | I/O COD | Serial Digital Video Device Control Data |



Table 3. SDVO, Display Port, HDMI /DVI, PCI Express* Signal Mapping

| Configuration-wise Mapping | | | | |
|----------------------------|-----------------|----------------|--------------|-------------|
| PCIe – Normal | PCIe – Reversed | SDVO Signal | Display Port | HDMI /DVI |
| PEG_TXP7 | PEG_TXP8 | SDVOC_CLKP | DPC_LANE3 | TMDS_CLK |
| PEG_TXN7 | PEG_TXN8 | SDVOC_CLKN | DPC_LANE3B | TMDS_CLKB |
| PEG_TXP6 | PEG_TXP9 | SDVOC_BLUE | DPC_LANE2 | TMDS_DATA0 |
| PEG_TXN6 | PEG_TXN9 | SDVOC_BLUE# | DPC_LANE2B | TMDS_DATA0B |
| PEG_TXP5 | PEG_TXP10 | SDVOC_GREEN | DPC_LANE1 | TMDS_DATA1 |
| PEG_TXN5 | PEG_TXN10 | SDVOC_GREEN# | DPC_LANE1B | TMDS_DATA1B |
| PEG_TXP4 | PEG_TXP11 | SDVOC_RED | DPC_LANE0 | TMDS_DATA2 |
| PEG_TXN4 | PEG_TXN11 | SDVOC_RED# | DPC_LANE0B | TMDS_DATA2B |
| PEG_TXP3 | PEG_TXP12 | SDVOB_CLKP | DPB_LANE3 | TMDS_CLK |
| PEG_TXN3 | PEG_TXN12 | SDVOB_CLKN | DPB_LANE3B | TMDS_CLKB |
| PEG_TXP2 | PEG_TXP13 | SDVOB_BLUE | DPB_LANE2 | TMDS_DATA0 |
| PEG_TXN2 | PEG_TXN13 | SDVOB_BLUE# | DPB_LANE2B | TMDS_DATA0B |
| PEG_TXP1 | PEG_TXP14 | SDVOB_GREEN | DPB_LANE1 | TMDS_DATA1 |
| PEG_TXN1 | PEG_TXN14 | SDVOB_GREEN# | DPB_LANE1B | TMDS_DATA1B |
| PEG_TXP0 | PEG_TXP15 | SDVOB_RED | DPB_LANE0 | TMDS_DATA2 |
| PEG_TXN0 | PEG_TXN15 | SDVOB_RED# | DPB_LANE0B | TMDS_DATA2B |
| PEG_RXP7 | PEG_RXP8 | | DPC_HPD | Port-C_HPD |
| PEG_RXN7 | PEG_RXN8 | | | |
| PEG_RXP6 | PEG_RXP9 | | DPC_AUX | |
| PEG_RXN6 | PEG_RXN9 | | DPC_AUXB | |
| PEG_RXP5 | PEG_RXP10 | SDVOC_INT | | |
| PEG_RXN5 | PEG_RXN10 | SDVOC_INT# | | |
| PEG_RXP4 | PEG_RXP11 | | | |
| PEG_RXN4 | PEG_RXN11 | | | |
| PEG_RXP3 | PEG_RXP12 | | DPB_HPD | Port-B_HPD |
| PEG_RXN3 | PEG_RXN12 | | | |
| PEG_RXP2 | PEG_RXP13 | SDVO_FLDSTALL | DPB_AUX | |
| PEG_RXN2 | PEG_RXN13 | SDVO_FLDSTALL# | DPB_AUXB | |
| PEG_RXP1 | PEG_RXP14 | SDVOB_INT | | |
| PEG_RXN1 | PEG_RXN14 | SDVOB_INT# | | |
| PEG_RXP0 | PEG_RXP15 | SDVO_TVCLKIN | | |



2.9 HDMI Interface (Intel® 82G45, 82G43, 82G41, 82B43 GMCH Only)

| Signal Name | Type | Description |
|---------------|-----------|-----------------------------------------------------------------------------------------------------------|
| HDMIB_CLK- | O PCIE | Serial Digital Video Channel B Clock Complement: Multiplexed with EXP_TXN_3/EXP_TXN_12. |
| HDMIB_CLK+ | O PCIE | Serial Digital Video Channel B Clock: Multiplexed with EXP_TXP_3/EXP_TXP_12. |
| HDMIB_RED- | O PCIE | Serial Digital Video Channel B Red Complement: Multiplexed with / EXP_TXN_0./EXP_TXN_15 |
| HDMIB_RED+ | O PCIE | Serial Digital Video Channel B Red: Multiplexed with EXP_TXP_0/EXP_TXP_15. |
| HDMIB_GREEN- | O PCIE | Serial Digital Video Channel B Green Complement: Multiplexed with EXP_TXN_1/EXP_TXN_14. |
| HDMIBGREEN+ | O PCIE | Serial Digital Video Channel B Green: Multiplexed with EXP_TXP_1/EXP_TXP_14. |
| HDMIB_BLUE- | O PCIE | Serial Digital Video Channel B Blue Complement. Multiplexed with EXP_TXN_2/EXP_TXN_13. |
| HDMIB_BLUE+ | O PCIE | Serial Digital Video Channel B Blue: Multiplexed with EXP_TXP_2/EXP_TXP_13. |
| HDMIC_RED- | O PCIE | Serial Digital Video Channel C Red Complement: Multiplexed with EXP_TXN_4/EXP_TXN_11. |
| HDMIC_RED+ | O PCIE | Serial Digital Video Channel C Red: Multiplexed with EXP_TXP_4/EXP_TXP_11. |
| HDMIC_GREEN- | O PCIE | Serial Digital Video Channel C Green Complement: Multiplexed with EXP_TXN_5/EXP_TXN_10. |
| HDMIC_GREEN+ | O PCIE | Serial Digital Video Channel C Green: Multiplexed with EXP_TXP_5/EXP_TXP_10. |
| HDMIC_BLUE- | O PCIE | Serial Digital Video Channel C Blue Complement: Multiplexed with EXP_TXN_6/EXP_TXN_9. |
| HDMIC_BLUE+ | O PCIE | Serial Digital Video Channel C Blue: Multiplexed with EXP_TXP_6/EXP_TXP_9. |
| HDMIC_CLK- | O PCIE | Serial Digital Video Channel C Clock Complement: Multiplexed with EXP_TXN_7/EXP_TXN_8. |
| HDMIC_CLK+ | O PCIE | Serial Digital Video Channel C Clock: Multiplexed with EXP_TXN_7/EXP_TXP_8. |
| HDMI_TVCLKIN- | I PCIE | Serial Digital Video TVOUT Synchronization Clock Complement: Multiplexed with EXP_RXN_0/EXP_RXN_15 |
| HDMI_TVCLKIN | I PCIE | Serial Digital Video TVOUT Synchronization Clock: Multiplexed with EXP_RXP_0/EXP_RXP_15. |
| HDMIB_INT- | I PCIE | Serial Digital Video Input Interrupt Complement: Multiplexed with EXP_RXN_3/EXP_RXN_12. |



| Signal Name | Type | Description |
|---------------|------------|------------------------------------------------------------------------------------|
| HDMIB_INT+ | I PCIE | Serial Digital Video Input Interrupt: Multiplexed with EXP_RXP_3/EXP_RXP_12 |
| HDMIC_INT- | I CIE | Serial Digital Video Input Interrupt: Multiplexed with EXP_RXN_7/EXP_RXN_8. |
| HDMIC_INT+ | I PCIE | Serial Digital Video Input Interrupt: Multiplexed with EXP_RXP_7/EXP_RXP_8. |
| SDVO_CTRLCLK | I/O COD | HDMI port B Control Clock: (This pin is shared with SDVO) |
| SDVO_CTRLDATA | I/O COD | HDMI port B Control Data: (This pin is shared with SDVO) |
| DDPC_CTRLCLK | I/O COD | HDMI port C Control Clock: Also used as the DP CTRLCLK |
| DDPC_CTRLDATA | I/O COD | HDMI port C Control Data: Also used as the DP CTRLDATA |

Note: HDMI support on 82B43 is enabled via Intel® Upgrade Service

2.10 Display Port Interface (Intel® 82Q45, 82Q43, 82B43, 82G45, 82G43, 82G41 GMCH Only)

| Signal Name | Type | Description |
|-------------|-----------|--------------------------------------------------------------------|
| DPB_AUX# | O PCIE | Display Port BAux channel: Multiplexed with EXP_RXN_02 |
| DPB_AUX | O PCIE | Display Port BAux channel: Multiplexed with EXP_RXP_02 |
| DPB_HDP | O PCIE | Display Port B Hot Plug Detect: Multiplexed with EXP_RXP_03 |
| DPC_AUX# | O PCIE | Display Port CAux channel: Multiplexed with EXP_RXN_06 |
| DPC_AUX | O PCIE | Display Port CAux channel: Multiplexed with EXP_RXP_06 |
| DPC_HDP | O PCIE | Display Port C Hot Plug Detect: Multiplexed with EXP_RXP_07 |
| DPB_LANE0# | O PCIE | Display Port B Data Lane: Multiplexed with EXP_TXN_00 |
| DPB_LANE0 | O PCIE | Display Port B Data Lane: Multiplexed with EXP_TXP_00 |
| DPB_LANE1# | O PCIE | Display Port B Data Lane: Multiplexed with EXP_TXN_01 |
| DPB_LANE1 | O PCIE | Display Port B Data Lane: Multiplexed with EXP_TXP_01 |



| Signal Name | Type | Description |
|-------------|-----------|--------------------------------------------------------------|
| DPB_LANE2# | O PCIE | Display Port B Data Lane: Multiplexed with EXP_TXN_02 |
| DPB_LANE2 | O PCIE | Display Port B Data Lane: Multiplexed with EXP_TXP_02 |
| DPB_LANE3# | O PCIE | Display Port B Data Lane: Multiplexed with EXP_TXN_03 |
| DPB_LANE3 | O PCIE | Display Port B Data Lane: Multiplexed with EXP_TXP_03 |
| DPC_LANE0# | O PCIE | Display Port C Data Lane: Multiplexed with EXP_TXN_04 |
| DPC_LANE0 | O PCIE | Display Port C Data Lane: Multiplexed with EXP_TXP_04 |
| DPC_LANE1# | O PCIE | Display Port C Data Lane: Multiplexed with EXP_TXN_05 |
| DPC_LANE1 | O PCIE | Display Port C Data Lane: Multiplexed with EXP_TXP_05 |
| DPC_LANE2# | O PCIE | Display Port C Data Lane: Multiplexed with EXP_TXN_06 |
| DPC_LANE2 | O PCIE | Display Port C Data Lane: Multiplexed with EXP_TXP_06 |
| DPC_LANE3# | O PCIE | Display Port C Data Lane: Multiplexed with EXP_TXN_07 |
| DPC_LANE3 | O PCIE | Display Port C Data Lane: Multiplexed with EXP_TXP_07 |

2.11 Intel® High Definition Audio Intel® 82Q45, 82Q43, 82B43, 82G45, 82G43, 82G41 GMCH Only)

| Name | Type | Description |
|----------|-----------|--------------------------------------------|
| HDA_BCLK | I CMOS | HDA Bus Clock |
| HDA_RST | I CMOS | HDA Reset |
| HDA_SDI | O CMOS | HDA Serial Data In: WRT ICH10/ICH7 |
| HDA_SDO | I CMOS | HDA Serial Data Out: WRT ICH10/ICH7 |
| HDA_SYNC | I CMOS | HDA Sync |



2.12 Power and Grounds

| Name | Voltage | Description |
|-------------|------------|-------------------------------------|
| VCC | 1.1 V | Core Power |
| VTT_FSB | 1.1 V | Processor System Bus Power |
| VCC_EXP | 1.5 V | PCI Express* and DMI Power |
| VCCA_EXP | 1.5 V | PCI Express* PLL Power |
| VCCAVRM_EXP | 1.1V | Internal PCIe Gen2 PLL filter |
| VCC_SM | 1.8 V/1.5V | DDR2/DDR3 System Memory Power |
| VCC_SMCLK | 1.8V/1.5V | DDR2/DDR3 System Clock Memory Power |
| VCCML_DDR | 1.1 V | DDR2/DDR3 Analog Power |
| VCC3_3 | 3.3 V | 3.3 V CMOS Power |
| VCCA_DPLLA | 1.1 V | Display PLL A Analog Power |
| VCCA_DPLLB | 1.1 V | Display PLL B Analog Power |
| VCCA_HPLL | 1.1 V | Host PLL Analog Power |
| VCCD_HPLL | 1.1V | Host PLL Analog Power |
| VCCA_MPLL | 1.1 V | System Memory PLL Analog Power |
| VCCA_DAC | 3.3 V | Display DAC Analog Power |
| VCC3_3 | 3.3 V | VCC 3.3 V |
| VCCDQ_CRT | 1.5/1.8 V | Display Digital Supply Power |
| VCC_CL | 1.1 V | Controller Link Aux Power |
| VCC_HDA | 1.5 V | Intel Integrated HDA Power |
| VSS | 0 V | Ground |

§ §

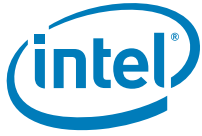

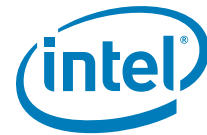

3 System Address Map

The (G)MCH supports 64 GB (36 bit) of host address space and 64 KB+3 of addressable I/O space. There is a programmable memory address space under the 1 MB region which is divided into regions which can be individually controlled with programmable attributes such as Disable, Read/Write, Write Only, or Read Only. Attribute programming is described in the Register Description section. This section focuses on how the memory space is partitioned and what the separate memory regions are used for. I/O address space has simpler mapping and is explained near the end of this section.

Note: References to the Internal Graphics Device (IGD) apply to the 82Q45, 82Q43, 82B43, 82G45, 82G43, and 82G41 GMCH only.

The (G)MCH supports PCI Express* upper pre-fetchable base/limit registers. This allows the PCI Express unit to claim IO accesses above 36 bit, complying with the *PCI Express Specification*. Addressing of greater than 8 GB is allowed on either the DMI Interface or PCI Express interface. The (G)MCH supports a maximum of 8 GB of DRAM. No DRAM memory will be accessible above 8 GB.

When running in internal graphics mode, writes to GMADR range linear range are supported. Write accesses to linear regions are supported from DMI only. Write accesses to tileX and tileY regions (defined via fence registers) are not supported from DMI or the PEG port. GMADR read accesses are not supported from either DMI or PEG.

In the following sections, it is assumed that all of the compatibility memory ranges reside on the DMI Interface. The exception to this rule is VGA ranges, which may be mapped to PCI Express or DMI, or to the internal graphics device (IGD). In the absence of more specific references, cycle descriptions referencing PCI should be interpreted as the DMI Interface/PCI, while cycle descriptions referencing PCI Express or IGD are related to the PCI Express bus or the internal graphics device respectively. The (G)MCH does not remap APIC or any other memory spaces above TOLUD (Top of Low Usable DRAM). The TOLUD register is set to the appropriate value by BIOS. The reclaim base/reclaim limit registers remap logical accesses bound for addresses above 4 GB onto physical addresses that fall within DRAM.

The Address Map includes a number of programmable ranges:

- Device 0
 - PXPEPBAR – Egress port registers. Necessary for setting up VC1 as an isochronous channel using time based weighted round robin arbitration. (4 KB window)
 - MCHBAR – Memory mapped range for internal (G)MCH registers. For example, memory buffer register controls. (16 KB window)
 - PCIEXBAR – Flat memory-mapped address spaced to access device configuration registers. This mechanism can be used to access PCI configuration space (0–FFh) and Extended configuration space (100h–FFFh) for PCI Express devices. This enhanced configuration access mechanism is defined in the PCI Express specification. (64 MB, 128 MB, or 256 MB window).
 - DMIBAR – This window is used to access registers associated with the Direct Media Interface (DMI) register memory range. (4 KB window)
 - GGCGMS – GMCH graphics control register, Graphics Mode Select (82Q45, 82Q43, 82B43, 82G45, 82G43, 82G41 GMCH only). This register is used to select the amount of main memory that is pre-allocated to support the internal

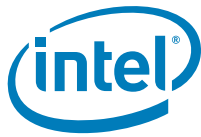

graphics device in VGA (non-linear) and Native (linear) modes. (0–256 MB options).

- GGCGGMS – GMCH graphics control register, GTT Graphics Memory Size (82Q45, 82Q43, 82B43, 82G45, 82G43, 82G41 GMCH only). This register is used to select the amount of main memory that is pre-allocated to support the Internal Graphics Translation Table. (0–2 MB options).

- Device 1
 - MBASE1/MLIMIT1 – PCI Express port non-prefetchable memory access window.
 - PMBASE1/PMLIMIT1 – PCI Express port prefetchable memory access window.
 - PMUBASE/PMULIMIT – PCI Express port upper prefetchable memory access window
 - IOBASE1/IOLIMIT1 – PCI Express port I/O access window.
- Device 2, Function 0 (82Q45, 82Q43, 82B43, 82G45, 82G43, 82G41 GMCH only)
 - MMADR – IGD registers and internal graphics instruction port. (512 KB window)
 - IOBAR – I/O access window for internal graphics. Though this window address/data register pair, using I/O semantics, the IGD and internal graphics instruction port registers can be accessed. Note that this allows accessing the same registers as MMADR. In addition, the IOBAR can be used to issue writes to the GTTADR table.
 - GMADR – Internal graphics translation window. (128 MB, 256 MB or 512 MB window).
 - GTTADR – Internal graphics translation table location. (1 MB window). Note that the Base of GTT stolen Memory register (Device 0 A8) indicates the physical address base which is 1 MB aligned.
- Device 2, Function 1 (82Q45, 82Q43, 82B43, 82G45, 82G43, 82G41 GMCH only)
 - MMADR – Function 1 IGD registers and internal graphics instruction port. (512 KB window)
- Device 3
 - ME Control
- Device 6, Function 0 (82P45 MCH only)
 - MBASE1/MLIMIT1 – PCI Express port non-prefetchable memory access window.
 - PMBASE1/PMLIMIT1 – PCI Express port prefetchable memory access window.
 - PMUBASE/PMULIMIT – PCI Express port upper prefetchable memory access window
 - IOBASE1/IOLIMIT1 – PCI Express port IO access window.

The rules for the above programmable ranges are:

1. ALL of these ranges MUST be unique and NON-OVERLAPPING. It is the BIOS or system designers' responsibility to limit memory population so that adequate PCI, PCI Express, High BIOS, and PCI Express Memory Mapped space, and APIC memory space can be allocated.
2. In the case of overlapping ranges with memory, the memory decode will be given priority. This is an Intel Trusted Execution Technology requirement. It is necessary to get Intel TET protection checks, avoiding potential attacks.
3. There are NO Hardware Interlocks to prevent problems in the case of overlapping ranges.
4. Accesses to overlapped ranges may produce indeterminate results.



5. The only peer-to-peer cycles allowed below the top of Low Usable memory (register TOLUD) are DMI Interface to PCI Express VGA range writes. Note that peer to peer cycles to the Internal Graphics VGA range are not supported.

Figure 5 represents system memory address map in a simplified form.

Figure 4. System Address Ranges

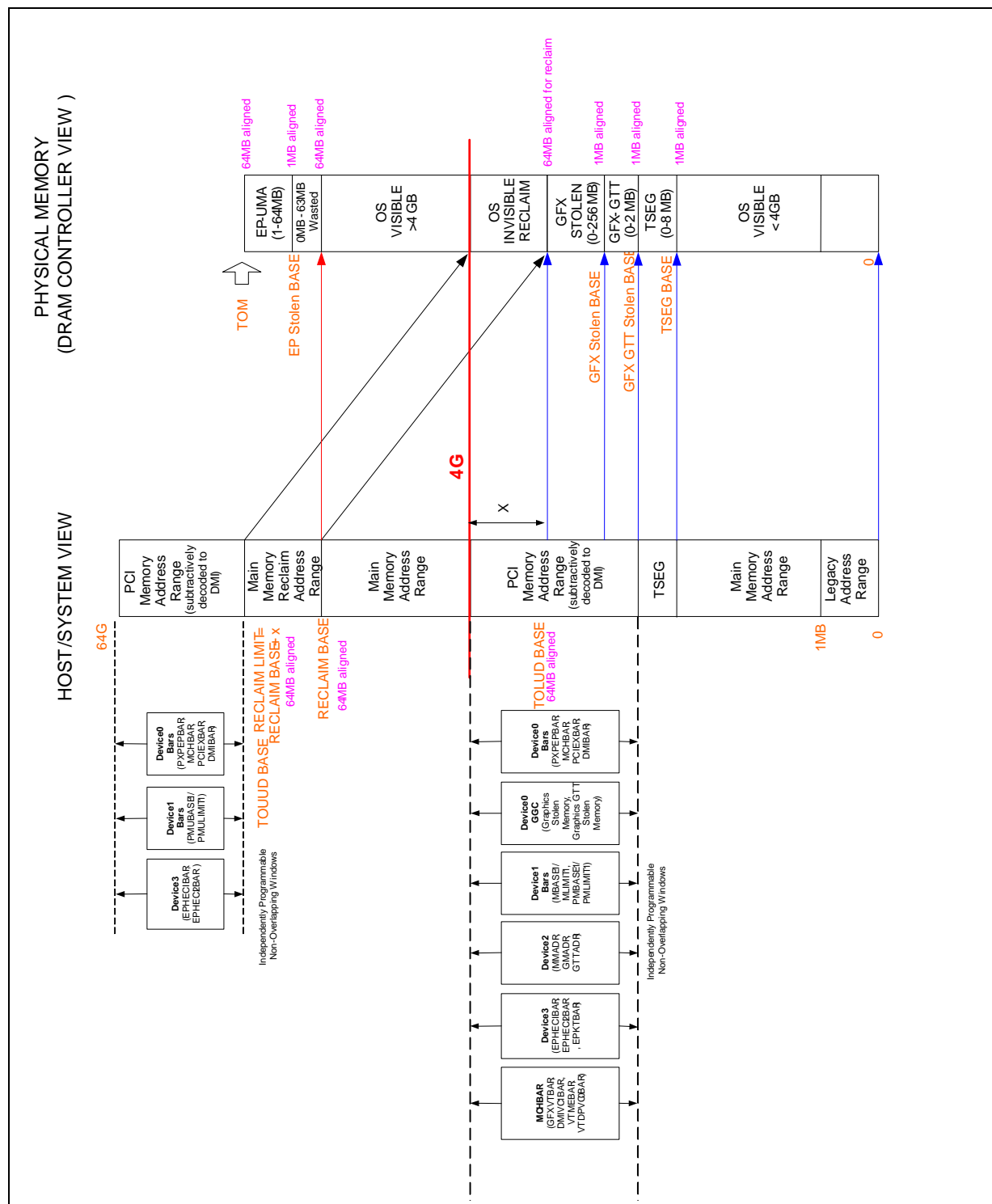

NOTE: For non-AMT system, do not follow the EP UMA requirement.



3.1 Legacy Address Range

This area is divided into the following address regions:

- 0 – 640 KB – DOS Area
- 640 – 768 KB – Legacy Video Buffer Area
- 768 – 896 KB in 16 KB sections (total of 8 sections) – Expansion Area
- 896 – 960 KB in 16 KB sections (total of 4 sections) – Extended System BIOS Area
- 960 KB - 1 MB Memory – System BIOS Area

Figure 5. DOS Legacy Address Range

| | | |
|------------|------------------------------------------------|--------|
| 000F_FFFFh | System BIOS (Upper) 64 KB | 1 MB |
| 000F_0000h | | 960 KB |
| 000E_FFFFh | Extended System BIOS (Lower) 64 KB (16KBx4) | 896 KB |
| 000E_0000h | | |
| 000D_FFFFh | Expansion Area 128 KB (16KBx8) | |
| 000C_0000h | | 768 KB |
| 000B_FFFFh | Legacy Video Area (SMM Memory) 128 KB | |
| 000A_0000h | | 640 KB |
| 0009_FFFFh | DOS Area | |
| 0000_0000h | | |

3.1.1 DOS Range (0h – 9_FFFFh)

The DOS area is 640 KB (0000_0000h – 0009_FFFFh) in size and is always mapped to the main memory controlled by the (G)MCH.

3.1.2 Legacy Video Area (A_0000h–B_FFFFh)

The legacy 128 KB VGA memory range, frame buffer, (000A_0000h – 000B_FFFFh) can be mapped to IGD (Device 2), to PCI Express (Device 1), and/or to the DMI Interface. The appropriate mapping depends on which devices are enabled and the programming of the VGA steering bits. Based on the VGA steering bits, priority for VGA mapping is constant. The (G)MCH always decodes internally mapped devices first. Internal to the (G)MCH, decode precedence is always given to IGD. The (G)MCH always positively decodes internally mapped devices, namely the IGD and PCI Express. Subsequent



decoding of regions mapped to PCI Express or the DMI Interface depends on the Legacy VGA configuration bits (VGA Enable and MDAP). This region is also the default for SMM space.

Compatible SMRAM Address Range (A_0000h–B_FFFFh)

When compatible SMM space is enabled, SMM-mode processor accesses to this range are routed to physical system DRAM at 000A 0000h – 000B FFFFh. Non-SMM-mode processor accesses to this range are considered to be to the Video Buffer Area as described above. PCI Express and DMI originated cycles to enabled SMM space are not allowed and are considered to be to the Video Buffer Area if IGD is not enabled as the VGA device. PCI Express and DMI initiated cycles are attempted as Peer cycles, and will master abort on PCI if no external VGA device claims them.

Monochrome Adapter (MDA) Range (B_0000h–B_7FFFh)

Legacy support requires the ability to have a second graphics controller (monochrome) in the system. Accesses in the standard VGA range are forwarded to IGD, PCI Express, or the DMI Interface (depending on configuration bits). Since the monochrome adapter may be mapped to anyone of these devices, the (G)MCH must decode cycles in the MDA range (000B_0000h – 000B_7FFFh) and forward either to IGD, PCI Express, or the DMI Interface. This capability is controlled by a VGA steering bits and the legacy configuration bit (MDAP bit). In addition to the memory range B0000h to B7FFFh, the (G)MCH decodes I/O cycles at 3B4h, 3B5h, 3B8h, 3B9h, 3BAh and 3BFh and forwards them to the either IGD, PCI Express, and/or the DMI Interface.

PEG 16-bit VGA Decode

The *PCI to PCI Bridge Architecture Specification, Revision 1.2*, states that 16-bit VGA decode be a feature.

It is expected that once the official version of the *PCI to PCI Bridge Architecture Specification, Revision 1.2*, has been released that Microsoft will include a Windows Logo program requirement that devices are compliant to this version of specification. A draft version of the Windows Logo Program 3.0 document includes this requirement as a proposed requirement; also Microsoft may potentially make this an out of band update to the existing WLP2.1a requirements.

The VGA 16-bit decode originally was described in an ECR to the *PCI to PCI Bridge Architecture Specification, Revision 1.1*, this is now listed as a required feature in the updated 1.2 specification.



3.1.3 Expansion Area (C_0000h-D_FFFFh)

This 128 KB ISA Expansion region (000C_0000h – 000D_FFFFh) is divided into eight 16 KB segments. Each segment can be assigned one of four Read/Write states: read-only, write-only, read/write, or disabled. Typically, these blocks are mapped through the (G)MCH and are subtractive decoded to ISA space. Memory that is disabled is not remapped.

Non-snooped accesses from PCI Express or DMI to this region are always sent to DRAM.

Table 4. Expansion Area Memory Segments

| Memory Segments | Attributes | Comments |
|-------------------|------------|-------------|
| 0C0000h – 0C3FFFh | WE RE | Add-on BIOS |
| 0C4000h – 0C7FFFh | WE RE | Add-on BIOS |
| 0C8000h – 0CBFFFh | WE RE | Add-on BIOS |
| 0CC000h – 0CFFFFh | WE RE | Add-on BIOS |
| 0D0000h – 0D3FFFh | WE RE | Add-on BIOS |
| 0D4000h – 0D7FFFh | WE RE | Add-on BIOS |
| 0D8000h – 0DBFFFh | WE RE | Add-on BIOS |
| 0DC000h – 0DFFFFh | WE RE | Add-on BIOS |

3.1.4 Extended System BIOS Area (E_0000h–E_FFFFh)

This 64 KB area (000E_0000h – 000E_FFFFh) is divided into four 16 KB segments. Each segment can be assigned independent read and write attributes so it can be mapped either to main DRAM or to DMI Interface. Typically, this area is used for RAM or ROM. Memory segments that are disabled are not remapped elsewhere.

Non-snooped accesses from PCI Express or DMI to this region are always sent to DRAM.

Table 5. Extended System BIOS Area Memory Segments

| Memory Segments | Attributes | Comments |
|-------------------|------------|----------------|
| 0E0000h – 0E3FFFh | WE RE | BIOS Extension |
| 0E4000h – 0E7FFFh | WE RE | BIOS Extension |
| 0E8000h – 0EBFFFh | WE RE | BIOS Extension |
| 0EC000h – 0EFFFFh | WE RE | BIOS Extension |



3.1.5 System BIOS Area (F_0000h–F_FFFFh)

This area is a single 64 KB segment (000F_0000h – 000F_FFFFh). This segment can be assigned read and write attributes. It is, by default (after reset), Read/Write disabled and cycles are forwarded to the DMI Interface. By manipulating the Read/Write attributes, the (G)MCH can “shadow” BIOS into the main DRAM. When disabled, this segment is not remapped.

Non-snooped accesses from PCI Express or DMI to this region are always sent to DRAM.

Table 6. System BIOS Area Memory Segments

| Memory Segments | Attributes | Comments |
|-------------------|------------|-----------|
| 0F0000h – 0FFFFFh | WE RE | BIOS Area |

3.1.6 PAM Memory Area Details

The 13 sections from 768 KB to 1 MB comprise what is also known as the PAM Memory Area.

The (G)MCH does not handle IWB (Implicit Write-Back) cycles targeting DMI. Since all memory residing on DMI should be set as non-cacheable, there will normally not be IWB cycles targeting DMI. However, DMI becomes the default target for processor and DMI originated accesses to disabled segments of the PAM region. If the MTRRs covering the PAM regions are set to WB or RD, it is possible to get IWB cycles targeting DMI. This may occur for processor-originated cycles (in a DP system) and for DMI-originated cycles to disabled PAM regions.

For example, say that a particular PAM region is set for “Read Disabled” and the MTRR associated with this region is set to WB. A DMI master generates a memory read targeting the PAM region. A snoop is generated on the FSB and the result is an IWB. Since the PAM region is “Read Disabled” the default target for the Memory Read becomes DMI. The IWB associated with this cycle will cause the (G)MCH to hang.

Non-snooped accesses from PCI Express or DMI to this region are always sent to DRAM.

3.2 Main Memory Address Range (1MB – TOLUD)

This address range extends from 1 MB to the top of Low Usable physical memory that is permitted to be accessible by the (G)MCH (as programmed in the TOLUD register). All accesses to addresses within this range will be forwarded by the (G)MCH to the DRAM unless it falls into the optional TSEG, or optional ISA Hole, or optional IGD stolen VGA memory.



Figure 6. Main Memory Address Range

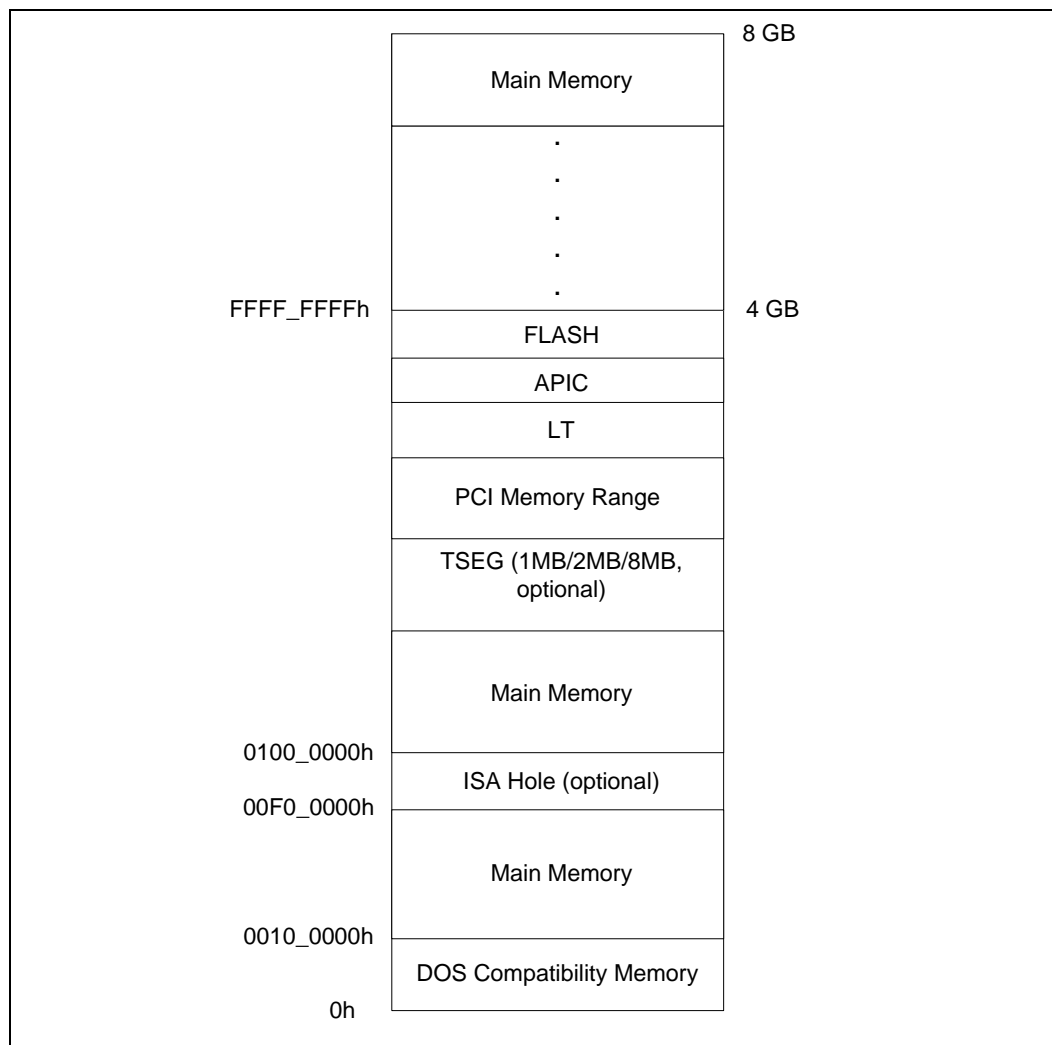

3.2.1 ISA Hole (15 MB –16 MB)

A hole can be created at 15 MB–16 MB as controlled by the fixed hole enable in Device 0 space. Accesses within this hole are forwarded to the DMI Interface. The range of physical DRAM memory disabled by opening the hole is not remapped to the top of the memory – that physical DRAM space is not accessible. This 15 MB–16 MB hole is an optionally enabled ISA hole.

Video accelerators originally used this hole. It is also used by validation and customer SV teams for some of their test cards. That is why it is being supported. There is no inherent BIOS request for the 15 MB–16 MB window.



3.2.2 TSEG

TSEG is optionally 1 MB, 2 MB, or 8 MB in size. TSEG is below IGD stolen memory, which is at the top of Low Usable physical memory (TOLUD). SMM-mode processor accesses to enabled TSEG access the physical DRAM at the same address. Non-processor originated accesses are not allowed to SMM space. PCI Express, DMI, and Internal Graphics originated cycles to enabled SMM space are handled as invalid cycle type with reads and writes to location 0 and byte enables turned off for writes. When the extended SMRAM space is enabled, processor accesses to the TSEG range without SMM attribute or without WB attribute are also forwarded to memory as invalid accesses. Non-SMM-mode Write Back cycles that target TSEG space are completed to DRAM for cache coherency. When SMM is enabled, the maximum amount of memory available to the system is equal to the amount of physical DRAM minus the value in the TSEG register, which is fixed at 1 MB, 2 MB, or 8 MB.

3.2.3 Pre-allocated Memory

Voids of physical addresses that are not accessible as general system memory and reside within system memory address range (< TOLUD) are created for SMM-mode, legacy VGA graphics compatibility, and GFX GTT stolen memory. **It is the responsibility of BIOS to properly initialize these regions.** Table 7 details the location and attributes of the regions. Enabling/Disabling these ranges are described in the (G)MCH Control Register Device 0 (GCC).

Table 7. Pre-allocated Memory Example for 64 MB DRAM, 1 MB VGA, 1 MB GTT Stolen and 1 MB TSEG

| Memory Segments | Attributes | Comments |
|-------------------------|---------------------------------|-------------------------------------------------------------------------------------------|
| 0000_0000h – 03CF_FFFFh | R/W | Available System Memory 61 MB |
| 03D0_0000h – 03DF_FFFFh | SMM Mode Only - processor Reads | TSEG Address Range & Pre-allocated Memory |
| 03E0_0000h – 03EF_FFFFh | R/W | Pre-allocated Graphics VGA memory. 1 MB (or 4/8/16/32/64/128/256 MB) when IGD is enabled. |
| 03F0_0000h – 03FF_FFFFh | R/W | Pre-allocated Graphics GTT stolen memory. 1 MB (or 2 MB) when IGD is enabled. |



3.3 PCI Memory Address Range (TOLUD – 4 GB)

This address range, from the top of low usable DRAM (TOLUD) to 4 GB is normally mapped to the DMI Interface.

Device 0 exceptions are:

- Addresses decoded to the egress port registers (PXPEPBAR).
- Addresses decoded to the memory mapped range for internal (G)MCH registers (GMCHBAR).
- Addresses decoded to the flat memory-mapped address spaced to access device configuration registers (PCIEXBAR).
- Addresses decoded to the registers associated with the Direct Media Interface (DMI) register memory range (DMIBAR).

With PCI Express port, there are two exceptions to this rule.

- Addresses decoded to the PCI Express Memory Window defined by the MBASE1, MLIMIT1, registers are mapped to PCI Express.
- Addresses decoded to the PCI Express prefetchable Memory Window defined by the PMBASE1, PMLIMIT1, registers are mapped to PCI Express.

In integrated graphics configurations, there are exceptions to this rule (82Q45, 82Q43, 82B43, 82G45, 82G43, 82G41 GMCH only):

1. Addresses decoded to the IGD registers and internal graphics instruction port (Function 0 MMADR, Function 1 MMADR).
2. Addresses decode to the internal graphics translation window (GMADR)
3. Addresses decode to the Internal graphics translation table (GTTADR)

In an Intel ME configuration, there are exceptions to this rule:

1. Addresses decoded to the ME Keyboard and Text MMIO range (EPKTBAR)
2. Addresses decoded to the ME HECI MMIO range (EPHEC1BAR)
3. Addresses decoded to the ME HECI2 MMIO range (EPHEC12BAR)

In a Virtualization Technology (VT) enable configuration, there are exceptions to this rule (82Q45 GMCH only):

1. Addresses decoded to the memory mapped window to Graphics VT remap engine registers (GFXVTBAR)
2. Addresses decoded to the memory mapped window to DMI VC1 VT remap engine registers (DMIVC1BAR)
3. Addresses decoded to the memory mapped window to ME VT remap engine registers (VTMEBAR)

Addresses decoded to the memory mapped window to PEG/DMI VC0 VT remap engine registers (VTDPVC0BAR)

Some of the MMIO Bars may be mapped to this range or to the range above TOLUD.

There are sub-ranges within the PCI Memory address range defined as APIC Configuration Space, FSB Interrupt Space, and High BIOS Address Range. The exceptions listed above for internal graphics and the PCI Express ports **MUST NOT overlap with these ranges.**

Figure 7. PCI Memory Address Range

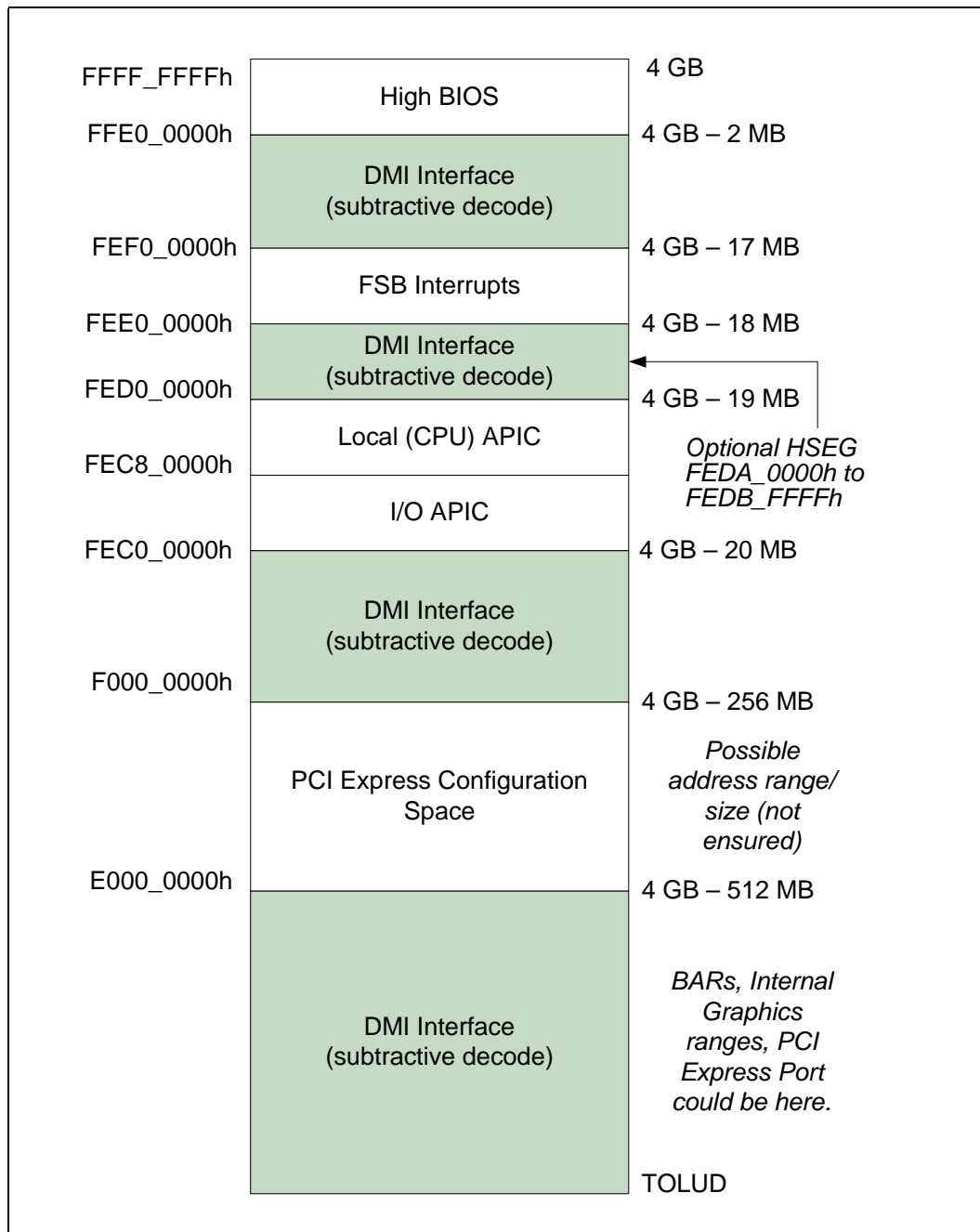



3.3.1 APIC Configuration Space (FEC0_0000h–FECF_FFFFh)

This range is reserved for APIC configuration space. The I/O APIC(s) usually reside in the ICH portion of the chip-set, but may also exist as stand-alone components like PXH.

The IOAPIC spaces are used to communicate with IOAPIC interrupt controllers that may be populated in the system. Since it is difficult to relocate an interrupt controller using plug-and-play software, fixed address decode regions have been allocated for them. Processor accesses to the default IOAPIC region (FEC0_0000h to FEC7_FFFFh) are always forwarded to DMI.

The (G)MCH optionally supports additional I/O APICs behind the PCI Express “Graphics” port. When enabled via the PCI Express Configuration register (Device 1 Offset 200h), the PCI Express port will positively decode a subset of the APIC configuration space – specifically FEC8_0000h through FECF_FFFFh. Memory request to this range would then be forwarded to the PCI Express port. This mode would be disabled in typical Desktop systems. When disabled, any access within entire APIC Configuration space (FEC0_0000h to FECF_FFFFh) is forwarded to DMI.

3.3.2 HSEG (FEDA_0000h–FEDB_FFFFh)

This optional segment from FEDA_0000h to FEDB_FFFFh provides a remapping window to SMM Memory. It is sometimes called the High SMM memory space. SMM-mode processor accesses to the optionally enabled HSEG are remapped to 000A_0000h–000B_FFFFh. Non-SMM-mode processor accesses to enabled HSEG are considered invalid and are terminated immediately on the FSB. The exceptions to this rule are Non-SMM-mode Write Back cycles which are remapped to SMM space to maintain cache coherency. PCI Express and DMI originated cycles to enabled SMM space are not allowed. Physical DRAM behind the HSEG transaction address is not remapped and is not accessible. All cacheline writes with WB attribute or Implicit write backs to the HSEG range are completed to DRAM like an SMM cycle.

3.3.3 FSB Interrupt Memory Space (FEE0_0000–FEEF_FFFF)

The FSB Interrupt space is the address used to deliver interrupts to the FSB. Any device on PCI Express or DMI may issue a Memory Write to 0FEEEx_xxxxh. The (G)MCH will forward this Memory Write along with the data to the FSB as an Interrupt Message Transaction. The (G)MCH terminates the FSB transaction by providing the response and asserting HTRDYB. This Memory Write cycle does not go to DRAM.

3.3.4 High BIOS Area

The top 2 MB (FFE0_0000h–FFFF_FFFFh) of the PCI Memory Address Range is reserved for System BIOS (High BIOS), extended BIOS for PCI devices, and the A20 alias of the system BIOS. The processor begins execution from the High BIOS after reset. This region is mapped to DMI Interface so that the upper subset of this region aliases to 16 MB–256 KB range. The actual address space required for the BIOS is less than 2 MB but the minimum processor MTRR range for this region is 2 MB so that full 2 MB must be considered.



3.4 Main Memory Address Space (4 GB to TOUUD)

The (G)MCH supports 36 bit addressing. The maximum main memory size supported is 8 GB total DRAM memory. A hole between TOLUD and 4 GB occurs when main memory size approaches 4 GB or larger. As a result, TOM, and TOUUD registers and RECLAIMBASE/RECLAIMLIMIT registers become relevant.

The new reclaim configuration registers exist to reclaim lost main memory space. The greater than 32 bit reclaim handling will be handled similar to other (G)MCHs.

Upstream read and write accesses above 36-bit addressing will be treated as invalid cycles by PEG and DMI.

Top of Memory

The “Top of Memory” (TOM) register reflects the total amount of populated physical memory. This is NOT necessarily the highest main memory address (holes may exist in main memory address map due to addresses allocated for memory mapped I/O above TOM). TOM is used to allocate the Intel Management Engine’s stolen memory. The Intel ME stolen size register reflects the total amount of physical memory stolen by the Intel ME. The ME stolen memory is located at the top of physical memory. The ME stolen memory base is calculated by subtracting the amount of memory stolen by the Intel ME from TOM.

The Top of Upper Usable Dram (TOUUD) register reflects the total amount of addressable DRAM. If reclaim is disabled, TOUUD will reflect TOM minus Intel ME stolen size. If reclaim is enabled, then it will reflect the reclaim limit. Also, the reclaim base will be the same as TOM minus ME stolen memory size to the nearest 64 MB alignment.

TOLUD register is restricted to 4 GB memory (A[31:20]), but the (G)MCH can support up to 16 GB, limited by DRAM pins. For physical memory greater than 4 GB, the TOUUD register helps identify the address range in between the 4 GB boundary and the top of physical memory. This identifies memory that can be directly accessed (including reclaim address calculation) which is useful for memory access indication, early path indication, and trusted read indication. When reclaim is enabled, TOLUD must be 64 MB aligned, but when reclaim is disabled, TOLUD can be 1 MB aligned.

C1DRB3 cannot be used directly to determine the effective size of memory as the values programmed in the DRBs depend on the memory mode (stacked, interleaved). The Reclaim Base/Limit registers also can not be used because reclaim can be disabled. The C0DRB3 register is used for memory channel identification (channel 0 vs. channel 1) in the case of stacked memory.



3.4.1 Memory Re-claim Background

The following are examples of Memory Mapped IO devices are typically located below 4 GB:

- High BIOS
- HSEG
- TSEG
- GFX stolen
- GTT stolen
- XAPIC
- Local APIC
- FSB Interrupts
- Mbase/Mlimit
- Memory Mapped I/O space that supports only 32-bit addressing

The (G)MCH provides the capability to re-claim the physical memory overlapped by the Memory Mapped I/O logical address space. The (G)MCH re-maps physical memory from the Top of Low Memory (TOLUD) boundary up to the 4 GB boundary to an equivalent sized logical address range located just below the Intel ME's stolen memory.

3.4.2 Memory Reclaiming

An incoming address (referred to as a logical address) is checked to see if it falls in the memory re-map window. The bottom of the re-map window is defined by the value in the RECLAIMBASE register. The top of the re-map window is defined by the value in the RECLAIMLIMIT register. An address that falls within this window is reclaimed to the physical memory starting at the address defined by the TOLUD register. The TOLUD register must be 64 MB aligned when RECLAIM is enabled, but can be 1 MB aligned when reclaim is disabled.

3.5 PCI Express* Configuration Address Space

There is a device 0 register, PCIEXBAR, which defines the base address for the configuration space associated with all devices and functions that are potentially a part of the PCI Express root complex hierarchy. The size of this range will be programmable for the (G)MCH. BIOS must assign this address range such that it will not conflict with any other address ranges.

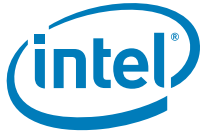

3.6 PCI Express* Address Space

The (G)MCH can be programmed to direct memory accesses to the PCI Express interface when addresses are within either of two ranges specified via registers in (G)MCH's Device 1 configuration space.

- The first range is controlled via the Memory Base Register (MBASE) and Memory Limit Register (MLIMIT) registers.
- The second range is controlled via the Pre-fetchable Memory Base (PMBASE) and Pre-fetchable Memory Limit (PMLIMIT) registers.

Conceptually, address decoding for each range follows the same basic concept. The top 12 bits of the respective Memory Base and Memory Limit registers correspond to address bits A[31:20] of a memory address. For the purpose of address decoding, the (G)MCH assumes that address bits A[19:0] of the memory base are zero and that address bits A[19:0] of the memory limit address are FFFFh. This forces each memory address range to be aligned to 1MB boundary and to have a size granularity of 1 MB.

The (G)MCH positively decodes memory accesses to PCI Express memory address space as defined by the following equations:

$$\text{Memory_Base_Address} \leq \text{Address} \leq \text{Memory_Limit_Address}$$

$$\text{Prefetchable_Memory_Base_Address} \leq \text{Address} \leq \text{Prefetchable_Memory_Limit_Address}$$

The window size is programmed by the plug-and-play configuration software. The window size depends on the size of memory claimed by the PCI Express device. Normally, these ranges will reside above the Top-of-Low Usable-DRAM and below High BIOS and APIC address ranges. They MUST reside above the top of low memory (TOLUD) if they reside below 4 GB and MUST reside above top of upper memory (TOUUD) if they reside above 4 GB or they will steal physical DRAM memory space.

It is essential to support a separate Pre-fetchable range in order to apply USWC attribute (from the processor point of view) to that range. The USWC attribute is used by the processor for write combining.

Note that the (G)MCH Device 1 memory range registers described above are used to allocate memory address space for any PCI Express devices sitting on PCI Express that require such a window.

The PCICMD1 register can override the routing of memory accesses to PCI Express. In other words, the memory access enable bit must be set in the device 1 PCICMD1 register to enable the memory base/limit and pre-fetchable base/limit windows.

For the (G)MCH, the upper PMUBASE1/PMULIMIT1 registers have been implemented for PCI Express Spec compliance. The (G)MCH locates MMIO space above 4 GB using these registers.



3.7 Graphics Memory Address Ranges (Intel® 82Q45, 82Q43, 82B43, 82G45, 82G43, 82G41 GMCH Only)

The GMCH can be programmed to direct memory accesses to IGD when addresses are within any of five ranges specified via registers in GMCH's Device 2 configuration space.

1. The Memory Map Base Register (MMADR) is used to access graphics control registers.
2. The Graphics Memory Aperture Base Register (GMADR) is used to access graphics memory allocated via the graphics translation table.
3. The Graphics Translation Table Base Register (GTTADR) is used to access the translation table.

These ranges can reside above the Top-of-Low-DRAM and below High BIOS and APIC address ranges. They **MUST** reside above the top of memory (TOLUD) and below 4 GB so they do not steal any physical DRAM memory space.

GMADR is a Prefetchable range in order to apply USWC attribute (from the processor point of view) to that range. The USWC attribute is used by the processor for write combining.

3.8 System Management Mode (SMM)

System Management Mode uses main memory for System Management RAM (SMM RAM). The (G)MCH supports: Compatible SMRAM (C_SMRAM), High Segment (HSEG), and Top of Memory Segment (TSEG). System Management RAM space provides a memory area that is available for the SMI handlers and code and data storage. This memory resource is normally hidden from the system OS so the processor has immediate access to this memory space upon entry to SMM. The (G)MCH provides three SMRAM options:

- Below 1 MB option that supports compatible SMI handlers.
- Above 1 MB option that allows new SMI handlers to execute with write-back cacheable SMRAM.
- Optional TSEG area of 1 MB, 2 MB, or 8 MB in size. For the 82Q45, 82Q43, 82B43, 82G45, 82G43, 82G41 GMCH, TSEG area lies below IGD stolen memory.

The above 1 MB solutions require changes to compatible SMRAM handlers code to properly execute above 1 MB.

Note: DMI Interface and PCI Express masters are not allowed to access the SMM space.

3.8.1 SMM Space Definition

SMM space is defined by its **addressed** SMM space and its DRAM SMM space. The addressed SMM space is defined as the range of bus addresses used by the processor to access SMM space. DRAM SMM space is defined as the range of physical DRAM memory locations containing the SMM code. SMM space can be accessed at one of three transaction address ranges: Compatible, High, and TSEG. The Compatible and TSEG SMM space is not remapped; therefore, the addressed and DRAM SMM space is the same address range. Since the High SMM space is remapped the addressed and DRAM SMM space is a different address range. Note that the High DRAM space is the same as the Compatible Transaction Address space. [Table 8](#) describes three unique address ranges:

- Compatible Transaction Address
- High Transaction Address
- TSEG Transaction Address



Table 8. Transaction Address Ranges – Compatible, High, and TSEG

| SMM Space Enabled | Transaction Address Space | DRAM Space (DRAM) |
|-------------------|-------------------------------------|-------------------------------------|
| Compatible | 000A_0000h to 000B_FFFFh | 000A_0000h to 000B_FFFFh |
| High | FEDA_0000h to FEDB_FFFFh | 000A_0000h to 000B_FFFFh |
| TSEG | (TOLUD–STOLEN–TSEG) to TOLUD–STOLEN | (TOLUD–STOLEN–TSEG) to TOLUD–STOLEN |

3.8.2 SMM Space Restrictions

If any of the following conditions are violated the results of SMM accesses are unpredictable and may cause the system to hang:

1. The Compatible SMM space **must not** be set-up as cacheable.
2. High or TSEG SMM transaction address space **must not** overlap address space assigned to system DRAM, or to any “PCI” devices (including DMI Interface, and PCI-Express, and graphics devices). This is a BIOS responsibility.
3. Both D_OPEN and D_CLOSE **must not** be set to 1 at the same time.
4. When TSEG SMM space is enabled, the TSEG space **must not** be reported to the OS as available DRAM. This is a BIOS responsibility.
5. Any address translated through the GMADR TLB must not target DRAM from A_0000-F_FFFF.

3.8.3 SMM Space Combinations

When High SMM is enabled (G_SMFRAME=1 and H_SMRAM_EN=1), the Compatible SMM space is effectively disabled. Processor-originated accesses to the Compatible SMM space are forwarded to PCI Express if VGAEN=1 (also depends on MDAP), otherwise they are forwarded to the DMI Interface. PCI Express and DMI Interface originated accesses are **never** allowed to access SMM space.

Table 9. SMM Space Table

| Global Enable G_SMFRAME | High Enable H_SMRAM_EN | TSEG Enable TSEG_EN | Compatible (C) Range | High (H) Range | TSEG (T) Range |
|----------------------------|---------------------------|------------------------|-------------------------|-------------------|-------------------|
| 0 | X | X | Disable | Disable | Disable |
| 1 | 0 | 0 | Enable | Disable | Disable |
| 1 | 0 | 1 | Enable | Disable | Enable |
| 1 | 1 | 0 | Disabled | Enable | Disable |
| 1 | 1 | 1 | Disabled | Enable | Enable |

3.8.4 SMM Control Combinations

The G_SMFRAME bit provides a global enable for all SMM memory. The D_OPEN bit allows software to write to the SMM ranges without being in SMM mode. BIOS software can use this bit to initialize SMM code at powerup. The D_LCK bit limits the SMM range access to only SMM mode accesses. The D_CLS bit causes SMM (both CSEG and TSEG) data accesses to be forwarded to the DMI Interface or PCI Express. The SMM software can use this bit to write to video memory while running SMM code out of DRAM.



Table 10. SMM Control Table

| G_SMRAME | D_LCK | D_CLS | D_OPEN | Processor in SMM Mode | SMM Code Access | SMM Data Access |
|----------|-------|-------|--------|-----------------------|-----------------|-----------------|
| 0 | x | X | x | x | Disable | Disable |
| 1 | 0 | X | 0 | 0 | Disable | Disable |
| 1 | 0 | 0 | 0 | 1 | Enable | Enable |
| 1 | 0 | 0 | 1 | x | Enable | Enable |
| 1 | 0 | 1 | 0 | 1 | Enable | Disable |
| 1 | 0 | 1 | 1 | x | Invalid | Invalid |
| 1 | 1 | X | x | 0 | Disable | Disable |
| 1 | 1 | 0 | x | 1 | Enable | Enable |
| 1 | 1 | 1 | x | 1 | Enable | Disable |

3.8.5 SMM Space Decode and Transaction Handling

Only the processor is allowed to access SMM space. PCI Express and DMI Interface originated transactions are not allowed to SMM space.

3.8.6 Processor WB Transaction to an Enabled SMM Address Space

Processor Writeback transactions (REQa[1]# = 0) to enabled SMM Address Space must be written to the associated SMM DRAM even though D_OPEN=0 and the transaction is not performed in SMM mode. This ensures SMM space cache coherency when cacheable extended SMM space is used.

3.8.7 SMM Access Through GTT TLB (Intel® 82Q45, 82Q43, 82B43, 82G45, 82G43, 82G41 GMCH Only)

Accesses through GTT TLB address translation to enabled SMM DRAM space are not allowed. Writes will be routed to Memory address 000C_0000h with byte enables de-asserted and reads will be routed to Memory address 000C_0000h. If a GTT TLB translated address hits enabled SMM DRAM space, an error is recorded.

PCI Express and DMI Interface originated accesses are **never** allowed to access SMM space directly or through the GTT TLB address translation. If a GTT TLB translated address hits enabled SMM DRAM space, an error is recorded.

PCI Express and DMI Interface write accesses through GMADR range will be snooped. Accesses to GMADR linear range (defined via fence registers) are supported. PCI Express and DMI Interface tileY and tileX writes to GMADR are not supported. If, when translated, the resulting physical address is to enabled SMM DRAM space, the request will be remapped to address 000C_0000h with de-asserted byte enables.

PCI Express and DMI Interface read accesses to the GMADR range are not supported therefore will have no address translation concerns. PCI Express and DMI Interface reads to GMADR will be remapped to address 000C_0000h. The read will complete with UR (unsupported request) completion status.

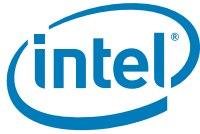

GTT Fetches are always decoded (at fetch time) to ensure not in SMM (actually, anything above base of TSEG or 640 KB–1 MB). Thus, they will be invalid and go to address 000C_0000h, but that is not specific to PCI Express or DMI; it applies to processor or internal graphics engines. Also, since the GMADR snoop would not be directly to the SMM space, there wouldn't be a writeback to SMM. In fact, the writeback would also be invalid (because it uses the same translation) and go to address 000C_0000h.

3.9 Memory Shadowing

Any block of memory that can be designated as read-only or write-only can be “shadowed” into (G)MCH DRAM memory. Typically this is done to allow ROM code to execute more rapidly out of main DRAM. ROM is used as a read-only during the copy process while DRAM at the same time is designated write-only. After copying, the DRAM is designated read-only so that ROM is shadowed. Processor bus transactions are routed accordingly.

3.10 I/O Address Space

The (G)MCH does not support the existence of any other I/O devices beside itself on the processor bus. The (G)MCH generates either DMI Interface or PCI Express bus cycles for all processor I/O accesses that it does not claim. Within the host bridge, the (G)MCH contains two internal registers in the processor I/O space, Configuration Address Register (CONFIG_ADDRESS) and the Configuration Data Register (CONFIG_DATA). These locations are used to implement configuration space access mechanism.

The processor allows 64 K+3 bytes to be addressed within the I/O space. The (G)MCH propagates the processor I/O address without any translation on to the destination bus and therefore provides addressability for 64K+3 byte locations. Note that the upper 3 locations can be accessed only during I/O address wrap-around when processor bus HAB_16 address signal is asserted. HAB_16 is asserted on the processor bus whenever an I/O access is made to 4 bytes from address 0FFFDh, 0FFFEh, or 0FFFFh. HAB_16 is also asserted when an I/O access is made to 2 bytes from address 0FFFFh.

A set of I/O accesses (other than ones used for configuration space access) are consumed by the internal graphics device if it is enabled. The mechanisms for internal graphics I/O decode and the associated control is explained later.

The I/O accesses (other than ones used for configuration space access) are forwarded normally to the DMI Interface bus unless they fall within the PCI Express I/O address range as defined by the mechanisms explained below. I/O writes are NOT posted. Memory writes to ICH or PCI Express are posted. The PCICMD1 register can disable the routing of I/O cycles to the PCI Express.

The (G)MCH responds to I/O cycles initiated on PCI Express or DMI with an UR status. Upstream I/O cycles and configuration cycles should never occur. If one does occur, the request will route as a read to Memory address 000C_0000h so a completion is naturally generated (whether the original request was a read or write). The transaction will complete with an UR completion status.

I/O reads that lie within 8-byte boundaries but cross 4-byte boundaries are issued from the processor as 1 transaction. The (G)MCH will break this into 2 separate transactions. I/O writes that lie within 8-byte boundaries but cross 4-byte boundaries are assumed to be split into 2 transactions by the processor.

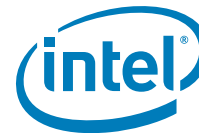

3.10.1 PCI Express* I/O Address Mapping

The (G)MCH can be programmed to direct non-memory (I/O) accesses to the PCI Express bus interface when processor initiated I/O cycle addresses are within the PCI Express I/O address range. This range is controlled via the I/O Base Address (IOBASE) and I/O Limit Address (IOLIMIT) registers in (G)MCH Device 1 configuration space.

Address decoding for this range is based on the following concept. The top 4 bits of the respective I/O Base and I/O Limit registers correspond to address bits A[15:12] of an I/O address. For the purpose of address decoding, the (G)MCH assumes that lower 12 address bits A[11:0] of the I/O base are zero and that address bits A[11:0] of the I/O limit address are FFFh. This forces the I/O address range alignment to 4 KB boundary and produces a size granularity of 4 KB.

The (G)MCH positively decodes I/O accesses to PCI Express I/O address space as defined by the following equation:

$$\text{I/O_Base_Address} \leq \text{Processor I/O Cycle Address} \leq \text{I/O_Limit_Address}$$

The effective size of the range is programmed by the plug-and-play configuration software and it depends on the size of I/O space claimed by the PCI Express device.

The (G)MCH also forwards accesses to the Legacy VGA I/O ranges according to the settings in the Device #1 configuration registers BCTRL (VGA Enable) and PCICMD1 (IOAE1), unless a second adapter (monochrome) is present on the DMI Interface/PCI (or ISA). The presence of a second graphics adapter is determined by the MDAP configuration bit. When MDAP is set, the (G)MCH will decode legacy monochrome I/O ranges and forward them to the DMI Interface. The IO ranges decoded for the monochrome adapter are 3B4h, 3B5h, 3B8h, 3B9h, 3BAh, and 3BFh.

Note that the (G)MCH Device 1 and/or Device 6 I/O address range registers defined above are used for all I/O space allocation for any devices requiring it (such a window on PCI Express).

The PCICMD1 register can disable the routing of I/O cycles to PCI Express.

3.11 (G)MCH Decode Rules and Cross-Bridge Address Mapping

VGAA = 000A_0000 – 000A_FFFF
 MDA = 000B_0000 – 000B_7FFF
 VGAB = 000B_8000 – 000B_FFFF
 MAINMEM = 0100_0000 to TOLUD
 HIGHMEM = 4 GB to TOM
 RECLAIMMEM = RECLAIMBASE to RECLAIMLIMIT

3.11.1 Legacy VGA and I/O Range Decode Rules

The legacy 128 KB VGA memory range 000A_0000h-000B_FFFFh can be mapped to IGD (Device 2), to PCI Express (Device 1), and/or to the DMI Interface depending on the programming of the VGA steering bits. Priority for VGA mapping is constant in that the (G)MCH always decodes internally mapped devices first. Internal to the (G)MCH, decode precedence is always given to IGD. The (G)MCH always positively decodes internally mapped devices, namely the IGD and PCI-Express. Subsequent decoding of regions mapped to PCI Express or the DMI Interface depends on the Legacy VGA configurations bits (VGA Enable and MDAP).

§ §

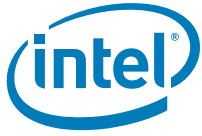



4 Register Description

The (G)MCH contains two sets of software accessible registers, accessed via the Host processor I/O address space: Control registers and internal configuration registers.

- Control registers are I/O mapped into the processor I/O space, which control access to PCI and PCI Express configuration space (see [Section 4.5](#)).
- Internal configuration registers residing within the (G)MCH are partitioned into logical device register sets ("logical" since they reside within a single physical device). One register set is dedicated to Host Bridge functionality (i.e., DRAM configuration, other chip-set operating parameters and optional features). Another register set is dedicated to Host-PCI Express Bridge functions (controls PCI Express interface configurations and operating parameters). The 82P45 has a second register set devoted to Host-PCI Express Bridge functions. There is also a register sets devoted to Management Engine (ME) Control. For the 82Q45, 82Q43, 82B43, 82G45, 82G43, 82G41 GMCH, a register set is for the internal graphics functions. The 82Q45 GMCH has register sets devoted to Intel Trusted Execution Technology and Intel Virtualization Technology.

The (G)MCH internal registers (I/O Mapped, Configuration and PCI Express Extended Configuration registers) are accessible by the Host processor. The registers that reside within the lower 256 bytes of each device can be accessed as Byte, Word (16 bit), or DWord (32 bit) quantities, with the exception of CONFIG_ADDRESS, which can only be accessed as a Dword. All multi-byte numeric fields use "little-endian" ordering (i.e., lower addresses contain the least significant parts of the field). Registers which reside in bytes 256 through 4095 of each device may only be accessed using memory mapped transactions in Dword (32 bit) quantities.

Some of the (G)MCH registers described in this section contain reserved bits. These bits are labeled "Reserved". Software must deal correctly with fields that are reserved. On reads, software must use appropriate masks to extract the defined bits and not rely on reserved bits being any particular value. On writes, software must ensure that the values of reserved bit positions are preserved. That is, the values of reserved bit positions must first be read, merged with the new values for other bit positions and then written back. Note the software does not need to perform read, merge, and write operation for the Configuration Address Register.

In addition to reserved bits within a register, the (G)MCH contains address locations in the configuration space of the Host Bridge entity that are marked either "Reserved" or "Intel Reserved". The (G)MCH responds to accesses to "Reserved" address locations by completing the host cycle. When a "Reserved" register location is read, a zero value is returned. ("Reserved" registers can be 8-, 16-, or 32 bits in size). Writes to "Reserved" registers have no effect on the (G)MCH. Registers that are marked as "Intel Reserved" must not be modified by system software. Writes to "Intel Reserved" registers may cause system failure. Reads from "Intel Reserved" registers may return a non-zero value.

Upon a Full Reset, the (G)MCH sets its entire set of internal configuration registers to predetermined default states. Some register values at reset are determined by external strapping options. The default state represents the minimum functionality feature set required to successfully bringing up the system. Hence, it does not represent the optimal system configuration. It is the responsibility of the system initialization software (usually BIOS) to properly determine the DRAM configurations, operating parameters and optional system features that are applicable, and to program the (G)MCH registers accordingly.



4.1 Register Terminology

The following table shows the register-related terminology that is used.

| Item | Definition |
|--------|---------------------------------------------------------------------------------------------------------------------------------------------------------------------------------------------------------------------------------------------------------------------------------------------------------------------------------------------------------------------------------------------------------------------------------------------------------------------------------------------------------------------------------------------------------------------------------------------------------------------------------------------------------------|
| RO | Read Only bit(s). Writes to these bits have no effect. This may be a status bit or a static value. |
| RO/S | Read Only / Sticky bit(s). Writes to these bits have no effect. These are status bits only. Bits are not returned to their default values by "warm" reset, but will be reset with a cold/complete reset (for PCI Express related bits a cold reset is "Power Good Reset" as defined in the PCI Express spec). |
| RS/WC | Read Set / Write Clear bit(s). The first time the bit is read with an enabled byte, it returns the value 0, but a side-effect of the read is that the value changes to 1. Any subsequent reads with enabled bytes return a 1 until a 1 is written to the bit. When the bit is read, but the byte is not enabled, the state of the bit does not change, and the value returned is irrelevant, but will match the state of the bit. When a 0 is written to the bit, there is no effect. When a 1 is written to the bit, its value becomes 0, until the next byte-enabled read. When the bit is written, but the byte is not enabled, there is no effect. |
| R/W | Read / Write bit(s). These bits can be read and written by software. Hardware may only change the state of this bit by reset. |
| R/WC | Read / Write Clear bit(s). These bits can be read. Internal events may set this bit. A software write of '1' clears (sets to '0') the corresponding bit(s) and a write of '0' has no effect. |
| R/WC/S | Read / Write Clear / Sticky bit(s). These bits can be read. Internal events may set this bit. A software write of '1' clears (sets to '0') the corresponding bit(s) and a write of '0' has no effect. Bits are not cleared by "warm" reset, but will be reset with a cold/complete reset (for PCI Express related bits a cold reset is "Power Good Reset" as defined in the PCI Express spec). |
| R/W/K | Read / Write / Key bit(s). These bits can be read and written by software. Additionally this bit, when set, prohibits some other bit field(s) from being writeable (bit fields become Read Only). |
| R/W/L | Read / Write / Lockable bit(s). These bits can be read and written by software. Additionally, there is a Key bit (which is marked R/W/K or R/W/L/K) that, when set, prohibits this bit field from being writeable (bit field becomes Read Only). |
| R/W/S | Read / Write / Sticky bit(s). These bits can be read and written by software. Bits are not cleared by "warm" reset, but will be reset with a cold/complete reset (for PCI Express related bits a cold reset is "Power Good Reset" as defined in the PCI Express spec). |
| R/W/SC | Read / Write / Self Clear bit(s). These bits can be read and written by software. When the bit is 1, hardware may clear the bit to '0' based upon internal events, possibly sooner than any subsequent software read could retrieve a 1. |

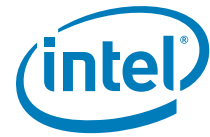

| Item | Definition |
|----------|---------------------------------------------------------------------------------------------------------------------------------------------------------------------------------------------------------------------------------------------------------------------------------------------------------------------------------------------------------------------------------------------------------------------|
| R/W/SC/L | Read / Write / Self Clear / Lockable bit(s). These bits can be read and written by software. When the bit is '1', hardware may clear the bit to '0' based upon internal events, possibly sooner than any subsequent software read could retrieve a '1'. Additionally there is a bit (which is marked R/W/K or R/W/L/K) that, when set, prohibits this bit field from being writeable (bit field becomes Read Only). |
| R/WO | Write Once bit(s). Once written by software, bits with this attribute become Read Only. These bits can only be cleared by a Reset. If there are multiple R/WO fields within a DWord, they should be written all at once (atomically) to avoid capturing an incorrect value. |
| W | Write Only. These bits may be written by software, but will always return zeros when read. They are used for write side-effects. Any data written to these registers cannot be retrieved. |

4.2 Configuration Process and Registers

4.2.1 Platform Configuration Structure

The DMI physically connects the (G)MCH and the Intel ICH10/ICH7; so, from a configuration standpoint, the DMI is logically PCI bus 0. As a result, all devices internal to the (G)MCH and the Intel ICH10/ICH7 appear to be on PCI bus 0.

The ICH10/ICH7 internal LAN controller does not appear on bus 0 – it appears on the external PCI bus (whose number is configurable).

The system's primary PCI expansion bus is physically attached to the Intel ICH10/ICH7 and, from a configuration perspective, appears to be a hierarchical PCI bus behind a PCI-to-PCI bridge and therefore has a programmable PCI Bus number. The PCI Express Graphics Attach appears to system software to be a real PCI bus behind a PCI-to-PCI bridge that is a device resident on PCI bus 0.

A physical PCI bus 0 does not exist and that DMI and the internal devices in the (G)MCH and Intel ICH10/ICH7 logically constitute PCI Bus 0 to configuration software. This is shown in the following figure.

The (G)MCH contains the following PCI devices within a single physical component. The configuration registers for the four devices are mapped as devices residing on PCI bus 0.

- **Device 0: Host Bridge/DRAM Controller.** Logically this appears as a PCI device residing on PCI bus 0. Device 0 contains the standard PCI header registers, PCI Express base address register, DRAM control (including thermal/throttling control), configuration for the DMI, and other (G)MCH specific registers.
- **Device 1: Host-PCI Express Bridge.** Logically this appears as a "virtual" PCI-to-PCI bridge residing on PCI bus 0 and is compliant with PCI Express Specification Revision 1.0. Device 1 contains the standard PCI-to-PCI bridge registers and the standard PCI Express/PCI configuration registers (including the PCI Express memory address mapping). It also contains Isochronous and Virtual Channel controls in the PCI Express extended configuration space.
- **Device 2: Internal Graphics Control (82Q45, 82Q43, 82B43, 82G45, 82G43, 82G41 GMCH only).** Logically, this appears as a PCI device residing on PCI bus #0. Physically, device 2 contains the configuration registers for 3D, 2D, and display functions.
- **Device 3: Management Engine Control.** ME control.



- **Device 6: Secondary Host-PCI Express Bridge.** (82P45 MCH only). Logically this appears as a “virtual” PCI-to-PCI bridge residing on PCI bus 0 and is compliant with *PCI Express Specification* Revision 1.0. Device 6 contains the standard PCI-to-PCI bridge registers and the standard PCI Express/PCI configuration registers (including the PCI Express memory address mapping). It also contains Isochronous and Virtual Channel controls in the PCI Express extended configuration space.

4.3 Configuration Mechanisms

The processor is the originator of configuration cycles so the FSB is the only interface in the platform where these mechanisms are used. Internal to the (G)MCH transactions received through both configuration mechanisms are translated to the same format.

4.3.1 Standard PCI Configuration Mechanism

The following is the mechanism for translating processor I/O bus cycles to configuration cycles.

The PCI specification defines a slot based “configuration space” that allows each device to contain up to 8 functions with each function containing up to 256 8-bit configuration registers. The PCI specification defines two bus cycles to access the PCI configuration space: Configuration Read and Configuration Write. Memory and I/O spaces are supported directly by the processor. Configuration space is supported by a mapping mechanism implemented within the (G)MCH.

The configuration access mechanism makes use of the CONFIG_ADDRESS Register (at I/O address 0CF8h though 0CFBh) and CONFIG_DATA Register (at I/O address 0CFCh though 0CFHh). To reference a configuration register a DW I/O write cycle is used to place a value into CONFIG_ADDRESS that specifies the PCI bus, the device on that bus, the function within the device and a specific configuration register of the device function being accessed. CONFIG_ADDRESS[31] must be 1 to enable a configuration cycle. CONFIG_DATA then becomes a window into the four bytes of configuration space specified by the contents of CONFIG_ADDRESS. Any read or write to CONFIG_DATA will result in the (G)MCH translating the CONFIG_ADDRESS into the appropriate configuration cycle.

The (G)MCH is responsible for translating and routing the processor’s I/O accesses to the CONFIG_ADDRESS and CONFIG_DATA registers to internal (G)MCH configuration registers, DMI or PCI Express.

4.3.2 PCI Express* Enhanced Configuration Mechanism

PCI Express extends the configuration space to 4096 bytes per device/function as compared to 256 bytes allowed by the PCI Specification, Revision 2.3. PCI Express configuration space is divided into a PCI 2.3 compatible region, which consists of the first 256B of a logical device’s configuration space and a PCI Express extended region which consists of the remaining configuration space.

The PCI compatible region can be accessed using either the Standard PCI Configuration Mechanism or using the PCI Express Enhanced Configuration Mechanism described in this section. The extended configuration registers may only be accessed using the PCI Express Enhanced Configuration Mechanism. To maintain compatibility with PCI configuration addressing mechanisms, system software must access the extended configuration space using 32-bit operations (32-bit aligned) only. These 32-bit operations include byte enables allowing only appropriate bytes within the DWord to be accessed. Locked transactions to the PCI Express memory mapped configuration address space are not supported. All changes made using either access mechanism are equivalent.



The PCI Express Enhanced Configuration Mechanism utilizes a flat memory-mapped address space to access device configuration registers. This address space is reported by the system firmware to the operating system. There is a register, PCIEXBAR, that defines the base address for the block of addresses below 4 GB for the configuration space associated with busses, devices and functions that are potentially a part of the PCI Express root complex hierarchy. In the PCIEXBAR register there exists controls to limit the size of this reserved memory mapped space. 256 MB is the amount of address space required to reserve space for every bus, device, and function that could possibly exist. Options for 128 MB and 64 MB exist in order to free up those addresses for other uses. In these cases the number of busses and all of their associated devices and functions are limited to 128 or 64 busses respectively.

The PCI Express Configuration Transaction Header includes an additional 4 bits (ExtendedRegisterAddress[3:0]) between the Function Number and Register Address fields to provide indexing into the 4 KB of configuration space allocated to each potential device. For PCI Compatible Configuration Requests, the Extended Register Address field must be all zeros.

Figure 8. Memory Map to PCI Express Device Configuration Space

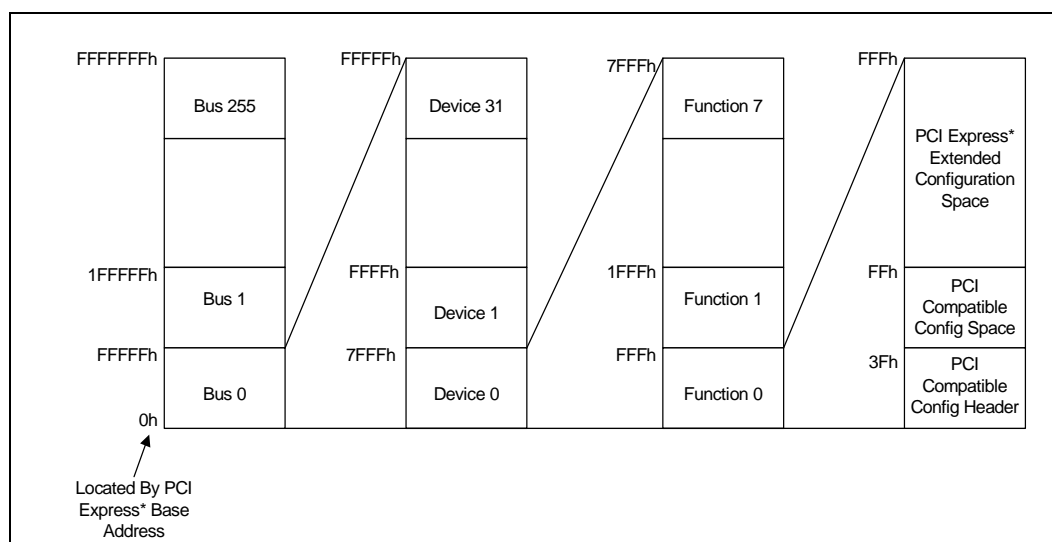

Just the same as with PCI devices, each device is selected based on decoded address information that is provided as a part of the address portion of Configuration Request packets. A PCI Express device will decode all address information fields (bus, device, function and extended address numbers) to provide access to the correct register.

To access this space (steps 1, 2, 3 are done only once by BIOS),

1. Use the PCI compatible configuration mechanism to enable the PCI Express enhanced configuration mechanism by writing 1 to bit 0 of the PCIEXBAR register.
2. Use the PCI compatible configuration mechanism to write an appropriate PCI Express base address into the PCIEXBAR register
3. Calculate the host address of the register you wish to set using (PCI Express base + (bus number * 1 MB) + (device number * 32KB) + (function number * 4 KB) + (1 B * offset within the function) = host address)
4. Use a memory write or memory read cycle to the calculated host address to write or read that register.

4.4 Routing Configuration Accesses

The (G)MCH supports two PCI related interfaces: DMI and PCI Express. The (G)MCH is responsible for routing PCI and PCI Express configuration cycles to the appropriate device that is an integrated part of the (G)MCH or to one of these two interfaces. Configuration cycles to the ICH10/ICH7 internal devices and Primary PCI (including downstream devices) are routed to the ICH10/ICH7 via DMI. Configuration cycles to both the PCI Express Graphics PCI compatibility configuration space and the PCI Express Graphics extended configuration space are routed to the PCI Express Graphics port device or associated link.

Figure 9. MCH Configuration Cycle Flow Chart

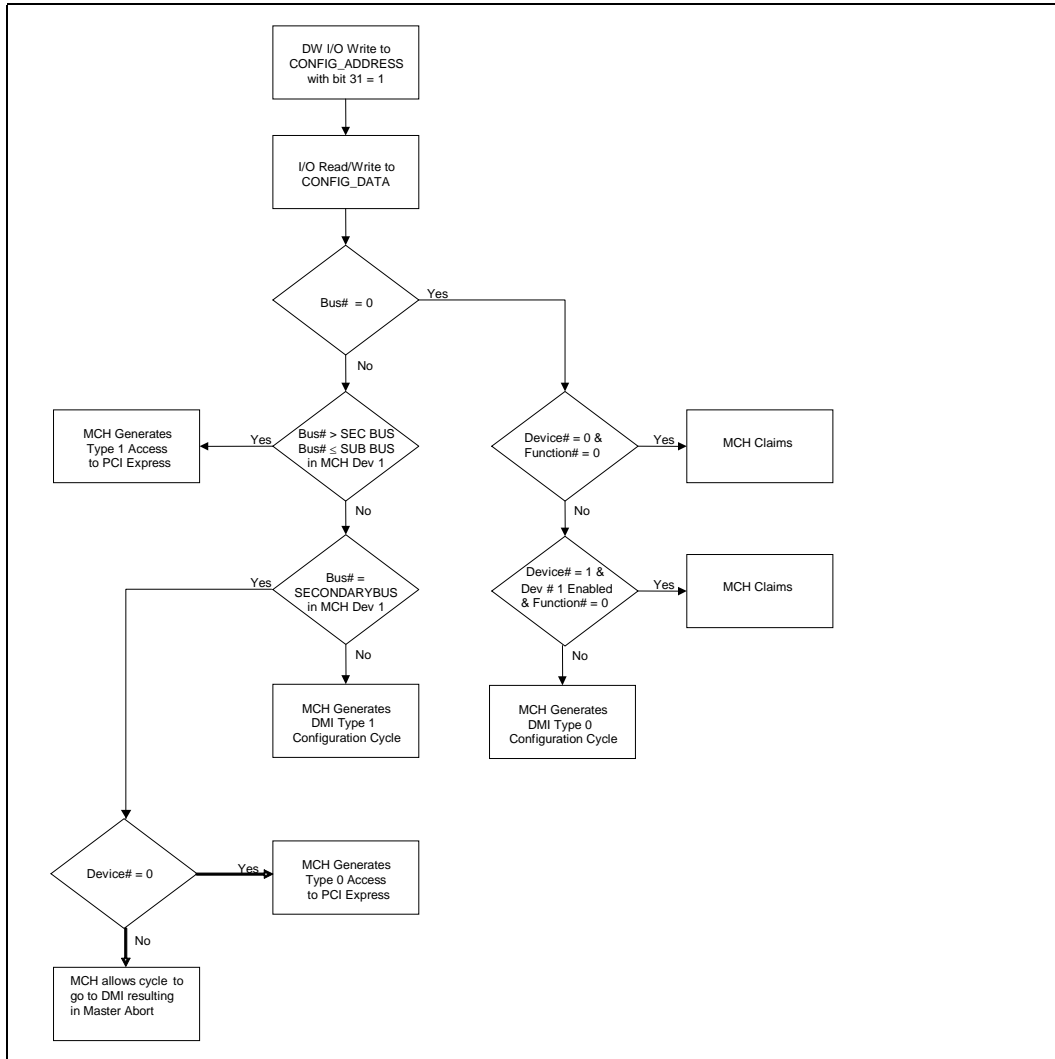



4.4.1 Internal Device Configuration Accesses

The (G)MCH decodes the Bus Number (bits 23:16) and the Device Number fields of the CONFIG_ADDRESS register. If the Bus Number field of CONFIG_ADDRESS is 0 the configuration cycle is targeting a PCI Bus 0 device.

If the targeted PCI Bus 0 device exists in the (G)MCH and is not disabled, the configuration cycle is claimed by the appropriate device.

4.4.2 Bridge Related Configuration Accesses

Configuration accesses on PCI Express or DMI are PCI Express Configuration TLPs.

- Bus Number [7:0] is Header Byte 8 [7:0]
- Device Number [4:0] is Header Byte 9 [7:3]
- Function Number [2:0] is Header Byte 9 [2:0]

And special fields for this type of TLP:

- Extended Register Number [3:0] is Header Byte 10 [3:0]
- Register Number [5:0] is Header Byte 11 [7:2]

See the PCI Express specification for more information on both the PCI 2.3 compatible and PCI Express Enhanced Configuration Mechanism and transaction rules.

4.4.2.1 PCI Express* Configuration Accesses

When the Bus Number of a type 1 Standard PCI Configuration cycle or PCI Express Enhanced Configuration access matches the Device 1 Secondary Bus Number a PCI Express Type 0 Configuration TLP is generated on the PCI Express link targeting the device directly on the opposite side of the link. This should be Device 0 on the bus number assigned to the PCI Express link (likely Bus 1).

The device on other side of link must be Device 0. The (G)MCH will Master Abort any Type 0 Configuration access to a non-zero Device number. If there is to be more than one device on that side of the link there must be a bridge implemented in the downstream device.

When the Bus Number of a type 1 Standard PCI Configuration cycle or PCI Express Enhanced Configuration access is within the claimed range (between the upper bound of the bridge device's Subordinate Bus Number register and the lower bound of the bridge device's Secondary Bus Number register) but does not match the Device 1 Secondary Bus Number, a PCI Express Type 1 Configuration TLP is generated on the secondary side of the PCI Express link.

PCI Express Configuration Writes:

- Internally the host interface unit will translate writes to PCI Express extended configuration space to configuration writes on the backbone.
- Writes to extended space are posted on the FSB, but non-posted on the PCI Express or DMI (i.e., translated to config writes)



4.4.2.2 DMI Configuration Accesses

Accesses to disabled (G)MCH internal devices, bus numbers not claimed by the Host-PCI Express bridge, or PCI Bus 0 devices not part of the (G)MCH will subtractively decode to the ICH10/ICH7 and consequently be forwarded over the DMI via a PCI Express configuration TLP.

If the Bus Number is zero, the (G)MCH will generate a Type 0 Configuration Cycle TLP on DMI. If the Bus Number is non-zero, and falls outside the range claimed by the Host-PCI Express bridge, the (G)MCH will generate a Type 1 Configuration Cycle TLP on DMI.

The ICH10/ICH7 routes configurations accesses in a manner similar to the (G)MCH. The ICH10/ICH7 decodes the configuration TLP and generates a corresponding configuration access. Accesses targeting a device on PCI Bus 0 may be claimed by an internal device. The ICH10/ICH7 compares the non-zero Bus Number with the Secondary Bus Number and Subordinate Bus Number registers of its PCI-to-PCI bridges to determine if the configuration access is meant for Primary PCI, or some other downstream PCI bus or PCI Express link.

Configuration accesses that are forwarded to the ICH10/ICH7, but remain unclaimed by any device or bridge will result in a master abort.

4.5 I/O Mapped Registers

The (G)MCH contains two registers that reside in the processor I/O address space – the Configuration Address (CONFIG_ADDRESS) Register and the Configuration Data (CONFIG_DATA) Register. The Configuration Address Register enables/disables the configuration space and determines what portion of configuration space is visible through the Configuration Data window.

4.5.1 CONFIG_ADDRESS—Configuration Address Register

| | |
|----------------|---------------------------|
| I/O Address: | 0CF8h Accessed as a DWord |
| Default Value: | 00000000h |
| Access: | R/W |
| Size: | 32 bits |

CONFIG_ADDRESS is a 32-bit register that can be accessed only as a DWord. A Byte or Word reference will "pass through" the Configuration Address Register and DMI onto the Primary PCI bus as an I/O cycle. The CONFIG_ADDRESS register contains the Bus Number, Device Number, Function Number, and Register Number for which a subsequent configuration access is intended.



| Bit | Access & Default | Description |
|-------|------------------|-----------------------------------------------------------------------------------------------------------------------------------------------------------------------------------------------------------------------------------------------------------------------------------------------------------------------------------------------------------------------------------------------------------------------------------------------------------------------------------------------------------------------------------------------------------------------------------------------------------------------------------------------------------------------------------------------------------------------------------------------------------------------------------------------------------------------------------------------------------------------------------------------------------------------------------------------------------------------------------------------------------------------------------------------------------------------------------------------------------------------------------------------------------------------|
| 31 | R/W 0b | Configuration Enable (CFGE): 0 = Disable 1 = Enable |
| 30:24 | | Reserved |
| 23:16 | R/W 00h | <p>Bus Number: If the Bus Number is programmed to 00h, the target of the Configuration Cycle is a PCI Bus 0 agent. If this is the case and the (G)MCH is not the target (i.e., the device number is ≥ 2), then a DMI Type 0 Configuration Cycle is generated.</p> <p>If the Bus Number is non-zero, and does not fall within the ranges enumerated by device 1's Secondary Bus Number or Subordinate Bus Number Register, then a DMI Type 1 Configuration Cycle is generated.</p> <p>If the Bus Number is non-zero and matches the value programmed into the Secondary Bus Number Register of device 1, a Type 0 PCI configuration cycle will be generated on PCI Express.</p> <p>If the Bus Number is non-zero, greater than the value in the Secondary Bus Number register of device 1 and less than or equal to the value programmed into the Subordinate Bus Number Register of device 1, a Type 1 PCI configuration cycle will be generated on PCI Express.</p> <p>This field is mapped to byte 8 [7:0] of the request header format during PCI Express Configuration cycles and A[23:16] during the DMI Type 1 configuration cycles.</p> |
| 15:11 | R/W 00h | <p>Device Number: This field selects one agent on the PCI bus selected by the Bus Number. When the Bus Number field is "00" the (G)MCH decodes the Device Number field. The (G)MCH is always Device Number 0 for the Host bridge entity, Device Number 1 for the Host-PCI Express entity. Therefore, when the Bus Number = 0 and the Device Number equals 0, 1, or 2 the internal (G)MCH devices are selected.</p> <p>This field is mapped to byte 6 [7:3] of the request header format during PCI Express Configuration cycles and A [15:11] during the DMI configuration cycles.</p> |
| 10:8 | R/W 000b | <p>Function Number: This field allows the configuration registers of a particular function in a multi-function device to be accessed. The (G)MCH ignores configuration cycles to its internal devices if the function number is not equal to 0 or 1.</p> <p>This field is mapped to byte 6 [2:0] of the request header format during PCI Express Configuration cycles and A[10:8] during the DMI configuration cycles.</p> |
| 7:2 | R/W 00h | <p>Register Number: This field selects one register within a particular Bus, Device, and Function as specified by the other fields in the Configuration Address Register.</p> <p>This field is mapped to byte 7 [7:2] of the request header format during PCI Express Configuration cycles and A[7:2] during the DMI Configuration cycles.</p> |
| 1:0 | | Reserved |

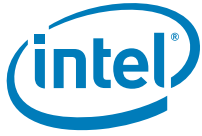

4.5.2 CONFIG_DATA—Configuration Data Register

I/O Address: 0CFCh
Default Value: 00000000h
Access: R/W
Size: 32 bits

CONFIG_DATA is a 32-bit read/write window into configuration space. The portion of configuration space that is referenced by CONFIG_DATA is determined by the contents of CONFIG_ADDRESS.

| Bit | Access & Default | Description |
|------|--------------------|---------------------------------------------------------------------------------------------------------------------------------------------------------------------------------------------------------------------------------------------------------------------------------------|
| 31:0 | R/W 0000 0000 h | Configuration Data Window (CDW): If bit 31 of CONFIG_ADDRESS is 1, any I/O access to the CONFIG_DATA register will produce a configuration transaction using the contents of CONFIG_ADDRESS to determine the bus, device, function, and offset of the register to be accessed. |

§ §



5 DRAM Controller Registers (D0:F0)

5.1 DRAM Controller Registers (D0:F0)

The DRAM Controller registers are in Device 0 (D0), Function 0 (F0).

Warning: Address locations that are not listed are considered Intel Reserved registers locations. Reads to Reserved registers may return non-zero values. Writes to reserved locations may cause system failures.

All registers that are defined in the PCI 2.3 specification, but are not necessary or implemented in this component are simply not included in this document. The reserved/unimplemented space in the PCI configuration header space is not documented as such in this summary.

Table 11. DRAM Controller Register Address Map (D0:F0) (Sheet 1 of 2)

| Address Offset | Register Symbol | Register Name | Default Value | Access |
|----------------|-----------------|-------------------------------------------------------------------------------------|--------------------------|-----------------------|
| 0–1h | VID | Vendor Identification | 8086h | RO |
| 2–3h | DID | Device Identification | see register description | RO |
| 4–5h | PCICMD | PCI Command | 0006h | RO, R/W |
| 6 | PCISTS | PCI Status | 0090h | RO, R/WC |
| 8h | RID | Revision Identification | see register description | RO |
| 9–Bh | CC | Class Code | 060000h | RO |
| Dh | MLT | Master Latency Timer | 00h | RO |
| Eh | HDR | Header Type | 00h | RO |
| 2C–2Ch | SVID | Subsystem Vendor Identification | 0000h | R/WO |
| 2E–2Fh | SID | Subsystem Identification | 0000h | R/WO |
| 34h | CAPPTR | Capabilities Pointer | E0h | RO |
| 40–47h | PXPEPBAR | PCI Express Egress Port Base Address | 000000000000 0000h | RO, R/W/L |
| 48–4Fh | MCHBAR | (G)MCH Memory Mapped Register Range Base | 000000000000 0000h | R/W/L, RO |
| 52–53h | GGC | GMCH Graphics Control Register (82Q45, 82Q43, 82B43, 82G45, 82G43, 82G41 GMCH only) | 0030h | R/W/L, RO |
| 54–57h | DEVEN | Device Enable | 000023DBh | RO, R/W/L |
| 60–67h | PCIEXBAR | PCI Express Register Range Base Address | 00000000E000 0000h | RO, R/W/L, R/W/L/K |
| 68–6Fh | DMIBAR | Root Complex Register Range Base Address | 000000000000 0000h | RO, R/W/L |
| 90h | PAM0 | Programmable Attribute Map 0 | 00h | RO, R/W/L |

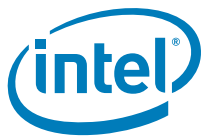

Table 11. DRAM Controller Register Address Map (D0:F0) (Sheet 2 of 2)

| Address Offset | Register Symbol | Register Name | Default Value | Access |
|----------------|-----------------|-------------------------------------------------------------------------------------|-------------------------------------|-------------------------|
| 91h | PAM1 | Programmable Attribute Map 1 | 00h | RO, R/W/L |
| 92h | PAM2 | Programmable Attribute Map 2 | 00h | RO, R/W/L |
| 93h | PAM3 | Programmable Attribute Map 3 | 00h | RO, R/W/L |
| 94h | PAM4 | Programmable Attribute Map 4 | 00h | RO, R/W/L |
| 95h | PAM5 | Programmable Attribute Map 5 | 00h | RO, R/W/L |
| 96h | PAM6 | Programmable Attribute Map 6 | 00h | RO, R/W/L |
| 97h | LAC | Legacy Access Control | 00h | R/W, R/W/L, RO |
| 98–99h | REMAPBASE | Remap Base Address Register | 03FFh | RO, R/W/L |
| 9A–9Bh | REMAPLIMIT | Remap Limit Address Register | 0000h | RO, R/W/L |
| 9Dh | SMRAM | System Management RAM Control | 02h | RO, R/W/L, R/W, R/W/L/K |
| 9Eh | ESMRAMC | Extended System Management RAM Control | 38h | R/W/L, R/WC, RO |
| A0–A1h | TOM | Top of Memory | 0001h | RO, R/W/L |
| A2–A3h | TOUUD | Top of Upper Usable Dram | 0000h | R/W/L |
| A4–A7h | GBSM | Graphics Base of Stolen Memory (82Q45, 82Q43, 82B43, 82G45, 82G43, 82G41 GMCH only) | 00000000h | R/W/L, RO |
| A8–ABh | BGSM | Base of GTT stolen Memory | 00000000h | R/W/L, RO |
| AC–AFh | TSEGMB | TSEG Memory Base | 00000000h | RO, R/W/L |
| B0–B1h | TOLUD | Top of Low Usable DRAM | 0010h | R/W/L, RO |
| C8–C9h | ERRSTS | Error Status | 0000h | RO, R/WC/S |
| CA–CBh | ERRCMD | Error Command | 0000h | R/W, RO |
| CC–CDh | SMICMD | SMI Command | 0000h | RO, R/W |
| DC–DFh | SKPD | Scratchpad Data | 00000000h | R/W |
| E0–ECh | CAPID0 | Capability Identifier | 000000000000 000000010C00 09h | RO |



5.1.1 VID—Vendor Identification

B/D/F/Type: 0/0/0/PCI
 Address Offset: 0-1h
 Default Value: 8086h
 Access: RO
 Size: 16 bits

This register combined with the Device Identification register uniquely identifies any PCI device.

| Bit | Access | Default Value | RST/ PWR | Description |
|------|--------|---------------|-------------|-----------------------------------------------------------------------------------|
| 15:0 | RO | 8086h | Core | Vendor Identification Number (VID): PCI standard identification for Intel. |

5.1.2 DID—Device Identification

B/D/F/Type: 0/0/0/PCI
 Address Offset: 2-3h
 Default Value: see table description
 Access: RO
 Size: 16 bits

This register combined with the Vendor Identification register uniquely identifies any PCI device.

| Bit | Access | Default Value | RST/ PWR | Description |
|------|--------|-----------------|-------------|------------------------------------------------------------------------------------------------------------------------------------------------------------------------------------------------------------|
| 15:0 | RO | see description | Core | Device Identification Number (DID): Identifier assigned to the (G)MCH core/primary PCI device. Refer to the <i>Intel® 4 Series Chipset Family Specification Update</i> for values in this register. |



5.1.3 PCICMD—PCI Command

B/D/F/Type: 0/0/0/PCI
 Address Offset: 4-5h
 Default Value: 0006h
 Access: RO, R/W
 Size: 16 bits

Since (G)MCH Device 0 does not physically reside on PCI_A many of the bits are not implemented.

| Bit | Access | Default Value | RST/PWR | Description |
|-------|--------|---------------|---------|-----------------------------------------------------------------------------------------------------------------------------------------------------------------------------------------------------------------------------------------------------------------------------------------------------------------------------------------------------------------------------------------------------------------------------------------------------------------------------------------------------------------------------------------------------------------------------------------------------------------------------------------------------------------------------------------------------------------------------------------------------------------------------------------------------------------------------------|
| 15:10 | RO | 00h | Core | Reserved |
| 9 | RO | 0b | Core | Fast Back-to-Back Enable (FB2B): This bit controls whether or not the master can do fast back-to-back write. Since device 0 is strictly a target this bit is not implemented and is hardwired to 0. Writes to this bit position have no effect. |
| 8 | R/W | 0b | Core | SERR Enable (SERRE): This bit is a global enable bit for Device 0 SERR messaging. The (G)MCH does not have an SERR signal. The (G)MCH communicates the SERR condition by sending an SERR message over DMI to the ICH. 1 = The (G)MCH is enabled to generate SERR messages over DMI for specific Device 0 error conditions that are individually enabled in the ERRCMD and DMIUEMSK registers. The error status is reported in the ERRSTS, PCISTS, and DMIUEST registers. 0 = The SERR message is not generated by the (G)MCH for Device 0. Note that this bit only controls SERR messaging for the Device 0. Device 1 has its own SERRE bits to control error reporting for error conditions occurring in that device. The control bits are used in a logical OR manner to enable the SERR DMI message mechanism. |
| 7 | RO | 0b | Core | Address/Data Stepping Enable (ADSTEP): Address/data stepping is not implemented in the (G)MCH, and this bit is hardwired to 0. Writes to this bit position have no effect. |
| 6 | R/W | 0b | Core | Parity Error Enable (PERRE): Controls whether or not the Master Data Parity Error bit in the PCI Status register can be set. 0 = Master Data Parity Error bit in PCI Status register can NOT be set. 1 = Master Data Parity Error bit in PCI Status register CAN be set. |
| 5 | RO | 0b | Core | VGA Palette Snoop Enable (VGASNOOP): The (G)MCH does not implement this bit and it is hardwired to a 0. |
| 4 | RO | 0b | Core | Memory Write and Invalidate Enable (MWIE): The (G)MCH will never issue memory write and invalidate commands. This bit is therefore hardwired to 0. |
| 3 | RO | 0b | Core | Special Cycle Enable (SCE): The (G)MCH does not implement this bit and it is hardwired to a 0. |



| Bit | Access | Default Value | RST/ PWR | Description |
|-----|--------|---------------|-------------|---------------------------------------------------------------------------------------------------------------------------------------|
| 2 | RO | 1b | Core | Bus Master Enable (BME): The (G)MCH is always enabled as a master on the backbone. This bit is hardwired to a 1. |
| 1 | RO | 1b | Core | Memory Access Enable (MAE): The (G)MCH always allows access to main memory. This bit is not implemented and is hardwired to 1. |
| 0 | RO | 0b | Core | I/O Access Enable (IOAE): This bit is not implemented in the (G)MCH and is hardwired to a 0. |

5.1.4 PCISTS—PCI Status

B/D/F/Type: 0/0/0/PCI
 Address Offset: 6-7h
 Default Value: 0090h
 Access: RO, R/WC
 Size: 16 bits

This status register reports the occurrence of error events on Device 0's PCI interface. Since the (G)MCH Device 0 does not physically reside on PCI_A many of the bits are not implemented.

| Bit | Access | Default Value | RST/ PWR | Description |
|------|--------|---------------|-------------|---------------------------------------------------------------------------------------------------------------------------------------------------------------------------------------------------------------------------------------------------------------------------------------------------------------------------------------------------------------------------------------|
| 15 | R/WC | 0b | Core | Detected Parity Error (DPE): This bit is set when this Device receives a Poisoned TLP. |
| 14 | R/WC | 0b | Core | Signaled System Error (SSE): This bit is set to 1 when the (G)MCH Device 0 generates an SERR message over DMI for any enabled Device 0 error condition. Device 0 error conditions are enabled in the PCICMD, ERRCMD, and DMIUEMSK registers. Device 0 error flags are read/reset from the PCISTS, ERRSTS, or DMIUEST registers. Software clears this bit by writing a 1 to it. |
| 13 | R/WC | 0b | Core | Received Master Abort Status (RMAS): This bit is set when the (G)MCH generates a DMI request that receives an Unsupported Request completion packet. Software clears this bit by writing a 1 to it. |
| 12 | R/WC | 0b | Core | Received Target Abort Status (RTAS): This bit is set when the (G)MCH generates a DMI request that receives a Completer Abort completion packet. Software clears this bit by writing a 1 to it. |
| 11 | RO | 0b | Core | Signaled Target Abort Status (STAS): The (G)MCH will not generate a Target Abort DMI completion packet or Special Cycle. This bit is not implemented in the (G)MCH and is hardwired to a 0. Writes to this bit position have no effect. |
| 10:9 | RO | 00b | Core | DEVSEL Timing (DEVT): These bits are hardwired to "00". Writes to these bit positions have no affect. Device 0 does not physically connect to PCI_A. These bits are set to "00" (fast decode) so that optimum DEVSEL timing for PCI_A is not limited by the (G)MCH. |



| Bit | Access | Default Value | RST/ PWR | Description |
|-----|--------|---------------|-------------|----------------------------------------------------------------------------------------------------------------------------------------------------------------------------------------------------------------------------------------------------------------------------------------------------------------------------------------------------------------------------------------------------------------------------------------|
| 8 | R/WC | 0b | Core | Master Data Parity Error Detected (DPD): This bit is set when DMI received a Poisoned completion from the ICH. This bit can only be set when the Parity Error Enable bit in the PCI Command register is set. |
| 7 | RO | 1b | Core | Fast Back-to-Back (FB2B): This bit is hardwired to 1. Writes to these bit positions have no effect. Device 0 does not physically connect to PCI_A. This bit is set to 1 (indicating fast back-to-back capability) so that the optimum setting for PCI_A is not limited by the (G)MCH. |
| 6 | RO | 0b | Core | Reserved |
| 5 | RO | 0b | Core | 66 MHz Capable: Does not apply to PCI Express. Must be hardwired to 0. |
| 4 | RO | 1b | Core | Capability List (CLIST): This bit is hardwired to 1 to indicate to the configuration software that this device/function implements a list of new capabilities. A list of new capabilities is accessed via register CAPPTR at configuration address offset 34h. Register CAPPTR contains an offset pointing to the start address within configuration space of this device where the Capability Identification register resides. |
| 3:0 | RO | 0000b | Core | Reserved |

5.1.5 RID—Revision Identification

B/D/F/Type: 0/0/0/PCI
 Address Offset: 8h
 Default Value: See description below
 Access: RO
 Size: 8 bits

This register contains the revision number of the (G)MCH Device 0. These bits are read only and writes to this register have no effect.

| Bit | Access | Default Value | RST/ PWR | Description |
|-----|--------|-----------------|-------------|--------------------------------------------------------------------------------------------------------------------------------------------------------------------------------------------------------------------------------------------------------|
| 7:0 | RO | See description | Core | Revision Identification Number (RID): This is an 8-bit value that indicates the revision identification number for the (G)MCH Device 0. Refer to the <i>Intel® 4 Series Chipset Family Specification Update</i> for the value of this register. |



5.1.6 CC—Class Code

B/D/F/Type: 0/0/0/PCI
 Address Offset: 9-Bh
 Default Value: 060000h
 Access: RO
 Size: 24 bits

This register identifies the basic function of the device, a more specific sub-class, and a register-specific programming interface.

| Bit | Access | Default Value | RST/PWR | Description |
|-------|--------|---------------|---------|--------------------------------------------------------------------------------------------------------------------------------------------------------------------------------------------------------------------------------|
| 23:16 | RO | 06h | Core | Base Class Code (BCC): This is an 8-bit value that indicates the base class code for the (G)MCH. 06h = Bridge device. |
| 15:8 | RO | 00h | Core | Sub-Class Code (SUBCC): This is an 8-bit value that indicates the category of Bridge into which the (G)MCH falls. 00h = Host Bridge. |
| 7:0 | RO | 00h | Core | Programming Interface (PI): This is an 8-bit value that indicates the programming interface of this device. This value does not specify a particular register set layout and provides no practical use for this device. |

5.1.7 MLT—Master Latency Timer

B/D/F/Type: 0/0/0/PCI
 Address Offset: Dh
 Default Value: 00h
 Access: RO
 Size: 8 bits

Device 0 in the (G)MCH is not a PCI master. Therefore, this register is not implemented.

| Bit | Access | Default Value | RST/PWR | Description |
|-----|--------|---------------|---------|-------------|
| 7:0 | RO | 00h | Core | Reserved |



5.1.8 HDR—Header Type

B/D/F/Type: 0/0/0/PCI
 Address Offset: Eh
 Default Value: 00h
 Access: RO
 Size: 8 bits

This register identifies the header layout of the configuration space. No physical register exists at this location.

| Bit | Access | Default Value | RST/ PWR | Description |
|-----|--------|---------------|-------------|-----------------------------------------------------------------------------------------------------------------------------------------------------------------------------------------------|
| 7:0 | RO | 00h | Core | PCI Header (HDR): This field always returns 00h to indicate that the (G)MCH is a single function device with standard header layout. Reads and writes to this location have no effect. |

5.1.9 SVID—Subsystem Vendor Identification

B/D/F/Type: 0/0/0/PCI
 Address Offset: 2C-2Dh
 Default Value: 0000h
 Access: R/WO
 Size: 16 bits

This value is used to identify the vendor of the subsystem.

| Bit | Access | Default Value | RST/ PWR | Description |
|------|--------|---------------|-------------|---------------------------------------------------------------------------------------------------------------------------------------------------------------------------------------|
| 15:0 | R/WO | 0000h | Core | Subsystem Vendor ID (SUBVID): This field should be programmed during boot-up to indicate the vendor of the system board. After it has been written once, it becomes read only. |

5.1.10 SID—Subsystem Identification

B/D/F/Type: 0/0/0/PCI
 Address Offset: 2E-2Fh
 Default Value: 0000h
 Access: R/WO
 Size: 16 bits

This value is used to identify a particular subsystem.

| Bit | Access | Default Value | RST/ PWR | Description |
|------|--------|---------------|-------------|------------------------------------------------------------------------------------------------------------------------------------------------|
| 15:0 | R/WO | 0000h | Core | Subsystem ID (SUBID): This field should be programmed during BIOS initialization. After it has been written once, it becomes read only. |



5.1.11 CAPPTR—Capabilities Pointer

B/D/F/Type: 0/0/0/PCI
 Address Offset: 34h
 Default Value: E0h
 Access: RO
 Size: 8 bits

The CAPPTR provides the offset that is the pointer to the location of the first device capability in the capability list.

| Bit | Access | Default Value | RST/PWR | Description |
|-----|--------|---------------|---------|------------------------------------------------------------------------------------------------------------------------------------------------------------------------------------------------------------------|
| 7:0 | RO | E0h | Core | Capabilities Pointer (CAPPTR): This field is a pointer to the offset of the first capability ID register block. In this case the first capability is the product-specific Capability Identifier (CAPID0). |

5.1.12 PXPEPBAR—PCI Express Egress Port Base Address

B/D/F/Type: 0/0/0/PCI
 Address Offset: 40-47h
 Default Value: 0000000000000000h
 Access: RO, R/W/L
 Size: 64 bits

This is the base address for the PCI Express Egress Port MMIO Configuration space. There is no physical memory within this 4 KB window that can be addressed. The 4 KB reserved by this register does not alias to any PCI 2.3 compliant memory mapped space. On reset, the EGRESS port MMIO configuration space is disabled and must be enabled by writing a 1 to PXPEPBAREN [Dev 0, offset 40h, bit 0]

Note: All the bits in this register are locked in Intel TXT mode (82Q45/82Q43 GMCH only).

| Bit | Access | Default Value | RST/PWR | Description |
|-------|--------|---------------|---------|-----------------------------------------------------------------------------------------------------------------------------------------------------------------------------------------------------------------------------------------------------------------------------------------------------------------------------------------------------------------------------------------------------------------------------------------------------------------------------------------------------|
| 63:36 | RO | 0000000h | Core | Reserved |
| 35:12 | R/W/L | 000000h | Core | PCI Express Egress Port MMIO Base Address (PXPEPBAR): This field corresponds to bits 35:12 of the base address PCI Express Egress Port MMIO configuration space. BIOS will program this register resulting in a base address for a 4 KB block of contiguous memory address space. This register ensures that a naturally aligned 4 KB space is allocated within the first 6 4GB of addressable memory space. System Software uses this base address to program the (G)MCH MMIO register set. |
| 11:1 | RO | 000h | Core | Reserved |
| 0 | R/W/L | 0b | Core | PXPEPBAR Enable (PXPEPBAREN): 0 = PXPEPBAR is disabled and does not claim any memory 1 = PXPEPBAR memory mapped accesses are claimed and decoded appropriately |



5.1.13 MCHBAR—(G)MCH Memory Mapped Register Range Base

B/D/F/Type: 0/0/0/PCI
 Address Offset: 48-4Fh
 Default Value: 0000000000000000h
 Access: R/W/L, RO
 Size: 64 bits

This is the base address for the (G)MCH Memory Mapped Configuration space. There is no physical memory within this 16 KB window that can be addressed. The 16 KB reserved by this register does not alias to any PCI 2.3 compliant memory mapped space. On reset, the (G)MCH MMIO Memory Mapped Configuration space is disabled and must be enabled by writing a 1 to MCHBAREN [Device 0, offset48h, bit 0].

All the bits in this register are locked in Intel TXT mode (82Q45/82Q43 GMCH only).

| Bit | Access | Default Value | RST/PWR | Description |
|-------|--------|---------------|---------|------------------------------------------------------------------------------------------------------------------------------------------------------------------------------------------------------------------------------------------------------------------------------------------------------------------------------------------------------------------------------------------------------------------------------------------------------------------------------------------------|
| 63:36 | RO | 0000000h | Core | Reserved |
| 35:14 | R/W/L | 000000h | Core | (G)MCH Memory Mapped Base Address (MCHBAR): This field corresponds to bits 35:14 of the base address (G)MCH Memory Mapped configuration space. BIOS will program this register resulting in a base address for a 16 KB block of contiguous memory address space. This register ensures that a naturally aligned 16 KB space is allocated within the first 64GB of addressable memory space. System Software uses this base address to program the (G)MCH Memory Mapped register set. |
| 13:1 | RO | 0000h | Core | Reserved |
| 0 | R/W/L | 0b | Core | MCHBAR Enable (MCHBAREN): 0 = MCHBAR is disabled and does not claim any memory 1 = MCHBAR memory mapped accesses are claimed and decoded appropriately |



5.1.14 GGC—GMCH Graphics Control Register (Intel® 82Q45, 82Q43, 82B43, 82G45, 82G43, 82G41 GMCH Only)

B/D/F/Type: 0/0/0/PCI
 Address Offset: 52-53h
 Default Value: 0030h
 Access: R/W/L, RO
 Size: 16 bits

Note: All the bits in this register are Intel TXT lockable (82Q45/82Q43 GMCH only).

| Bit | Access | Default Value | RST/PWR | Description |
|-------|--------|---------------|---------|-------------------------------------------------------------------------------------------------------------------------------------------------------------------------------------------------------------------------------------------------------------------------------------------------------------------------------------------------------------------------------------------------------------------------------------------------------------------------------------------------------------------------------------------------------------------------------------------------------------------------------------------------------------------------------------------------------------------------------------------------------------------------------------------------------------------------------------------------------------------------------------------------------------------------------------------------------------------------------------------------------------------------------------------------------------------------------------------------------------------------------------------------------------------------------------------------------------------------------------------------------------------------------------------------------------------------------------------------|
| 15:12 | RO | 0h | Core | Reserved |
| 11:8 | R/W/L | 0h | Core | <p>GTT Graphics Memory Size (GGMS): This field is used to select the amount of Main Memory that is pre-allocated to support the Internal Graphics Translation Table. The BIOS ensures that memory is pre-allocated only when Internal graphics is enabled. GSM is assumed to be a contiguous physical DRAM space with DSM, and BIOS needs to allocate a contiguous memory chunk. Hardware will drive the base of GSM from DSM only using the GSM size programmed in the register.</p> <p>0000 = No memory pre-allocated. 0001 = No VT mode, 1 MB of memory pre-allocated for GTT. 0011 = No VT mode, 2 MB of memory pre-allocated for GTT 1001 = VT mode, 2 MB of memory pre-allocated for 1 MB of Global GTT and 1 MB for Shadow GTT 1010 = VT mode, 3 MB of memory pre-allocated for 1.5 MB of Global GTT and 1.5 MB for Shadow GTT (82Q45 GMCH only) 1011 = VT mode, 4 MB of memory pre-allocated for 2 MB of Global GTT and 2 MB for Shadow GTT. (82Q45 GMCH only)</p> <p>NOTE: All unspecified encodings of this register field are reserved, hardware functionality is not assured if used. This register is locked and becomes Read Only when the D_LCK bit in the SMRAM register is set.</p> |



| Bit | Access | Default Value | RST/ PWR | Description |
|-----|--------|---------------|-------------|------------------------------------------------------------------------------------------------------------------------------------------------------------------------------------------------------------------------------------------------------------------------------------------------------------------------------------------------------------------------------------------------------------------------------------------------------------------------------------------------------------------------------------------------------------------------------------------------------------------------------------------------------------------------------------------------------------------------------------------------------------------------------------------------------------------------------------------------------------------------------------------------------------------------------------------------------------------------------------------------------------------------------------------------------------------------------------------------------------------------------------------------------------------------------------------------------------------------------------------------------------------------------------------------------------------------------------------------------------------------------------------------------------------------------------------------------------------------------------------------------------------------------------------------------------------------------------------------------------------------------------------------|
| 7:4 | R/W/L | 0011b | Core | <p>Graphics Mode Select (GMS): This field is used to select the amount of Main Memory that is pre-allocated to support the Internal Graphics device in VGA (non-linear) and Native (linear) modes. The BIOS ensures that memory is pre-allocated only when Internal graphics is enabled.</p> <p>0000 = No memory pre-allocated. Device 2 (IGD) does not claim VGA cycles (Memory and I/O), and the Sub-Class Code field within Device 2, Function 0 Class Code register is 80h.</p> <p>0001 = Reserved</p> <p>0010 = Reserved</p> <p>0011 = Reserved</p> <p>0100 = Reserved</p> <p>0101 = DVMT (UMA) mode, 32 MB of memory pre-allocated for frame buffer.</p> <p>0110 = DVMT (UMA) mode, 48 MB of memory pre-allocated for frame buffer.</p> <p>0111 = DVMT (UMA) mode, 64 MB of memory pre-allocated for frame buffer.</p> <p>1000 = DVMT (UMA) mode, 128 MB of memory pre-allocated for frame buffer.</p> <p>1001 = DVMT (UMA) mode, 256 MB of memory pre-allocated for frame buffer.</p> <p>1010 = DVMT (UMA) mode, 96 MB of memory pre-allocated (0 + 96).</p> <p>1011 = DVMT (UMA) mode, 160 MB of memory pre-allocated (64 + 96).</p> <p>1100 = DVMT (UMA) mode, 224 MB of memory pre-allocated (128 + 96).</p> <p>1101 = DVMT (UMA) mode, 352 MB of memory pre-allocated (256 + 96).</p> <p>NOTE: This register is locked and becomes Read Only when the D_LCK bit in the SMRAM register is set.</p> <p>Hardware does not clear or set any of these bits automatically based on IGD being disabled/enabled.</p> <p>IOS Requirement: BIOS must not set this field to 000 if IVD (bit 1 of this register) is 0.</p> |
| 3:2 | RO | 00b | Core | Reserved |
| 1 | R/W/L | 0b | Core | <p>IGD VGA Disable (IVD):</p> <p>0 = Enable. Device 2 (IGD) claims VGA memory and IO cycles, the Sub-Class Code within Device 2 Class Code register is 00h.</p> <p>1 = Disable. Device 2 (IGD) does not claim VGA cycles (Memory and I/O), and the Sub- Class Code field within Device 2, Function 0 Class Code register is 80h.</p> <p>BIOS Requirement: BIOS must not set this bit to 0 if the GMS field (bits 6:4 of this register) pre-allocates no memory. This bit MUST be set to 1 if Device 2 is disabled either via a fuse or fuse override (CAPID0[46] = 1) or via a register (DEVEN[3] = 0).</p> <p>This register is locked by Intel TXT (82Q45/82Q43 GMCH only) or ME stolen Memory lock.</p> |
| 0 | RO | 0b | Core | Reserved |



5.1.15 DEVEN—Device Enable

B/D/F/Type: 0/0/0/PCI
 Address Offset: 54-57h
 Default Value: 000023DBh
 Access: RO, R/W/L
 Size: 32 bits

Allows for enabling/disabling of PCI devices and functions that are within the (G)MCH. The table below the bit definitions describes the behavior of all combinations of transactions to devices controlled by this register.

Note: All the bits in this register are Intel TXT Lockable (82Q45/82Q43 GMCH only).

| Bit | Access | Default Value | RST/ PWR | Description |
|------------------------------------------------------------------|--------|---------------|-------------|----------------------------------------------------------------------------------------------------------------------------------------------------------------------------------------------------------------------------------------------------------------------------------------------------------------------------------------------------------------------------------------------------------------------------------------------------------------------------|
| 31:15 | RO | 00000h | Core | Reserved |
| 14 | R/W/L | 0b | Core | Reserved |
| 13 (82P45 MCH only) | R/W/L | 1b | Core | PEG1 Enable (D6EN): 0 = Bus 0, Device 6 is disabled and hidden. 1 = Bus 0, Device 6 is enabled and visible. |
| 13 (82Q45, 82Q43, 82B43, 82G45, 82G43, 82G41, 82P43 (G)MCH only) | R/W/L | 1b | Core | Reserved |
| 12:10 | RO | 000b | Core | Reserved |
| 9 | R/W/L | 1b | Core | EP Function 3 (D3F3EN): 0 = Bus 0, Device 3, Function 3 is disabled and hidden 1 = Bus 0, Device 3, Function 3 is enabled and visible If Device 3, Function 0 is disabled and hidden, then Device 3, Function 3 is also disabled and hidden independent of the state of this bit. If this (G)MCH does not have ME capability (CAPID0[57] = 1 or CAPID0[56] = 1), then Device 3, Function 3 is disabled and hidden independent of the state of this bit. |
| 8 | R/W/L | 1b | Core | EP Function 2 (D3F2EN): 0 = Bus 0, Device 3, Function 2 is disabled and hidden 1 = Bus 0, Device 3, Function 2 is enabled and visible If Device 3, Function 0 is disabled and hidden, then Device 3, Function 2 is also disabled and hidden independent of the state of this bit. If this (G)MCH does not have ME capability (CAPID0[57] = 1 or CAPID0[56] = 1) then Device 3 Function 2 is disabled and hidden independent of the state of this bit. |
| 7 | R/W/L | 1b | Core | EP Function 1 (D3F1EN): 0 = Bus 0, Device 3, Function 1 is disabled and hidden 1 = Bus 0, Device 3, Function 1 is enabled and visible. If Device 3, Function 0 is disabled and hidden, then Device 3, Function 1 is also disabled and hidden independent of the state of this bit. |



| Bit | Access | Default Value | RST/ PWR | Description |
|-----------------------------------------------------------------------|--------|---------------|-------------|-----------------------------------------------------------------------------------------------------------------------------------------------------------------------------------------------------------------------------------------------------------------------------------------------------------------------------------------------------------------------------------------------------------------------------------------------------------------------------------------------------------------|
| 6 | R/W/L | 1b | Core | EP Function 0 (D3F0EN): 0 = Bus 0, Device 3, Function 0 is disabled and hidden 1 = Bus 0, Device 3, Function 0 is enabled and visible. |
| 5 | RO | 0b | Core | Reserved |
| 4 (82Q45, 82Q43, 82B43, 82G45, 82G43, 82G41 GMCH Only) | R/W/L | 1b | Core | Internal Graphics Engine Function 1 (D2F1EN): 0 = Bus 0, Device 2, Function 1 is disabled and hidden 1 = Bus 0, Device 2, Function 1 is enabled and visible If Device 2, Function 0 is disabled and hidden, then Device 2, Function 1 is also disabled and hidden independent of the state of this bit. If this component is not capable of Dual Independent Display (CAPID0[78] = 1), then this bit is hardwired to 0b to hide Device 2, Function 1. |
| 4 (82P45, 82P43 MCH Only) | R/W/L | 1b | Core | Reserved |
| 3 (82Q45, 82Q43, 82B43, 82G45, 82G43, 82G41 GMCH Only) | R/W/L | 1b | Core | Internal Graphics Engine Function 0 (D2F0EN): 0 = Bus 0, Device 2, Function 0 is disabled and hidden 1 = Bus 0, Device 2, Function 0 is enabled and visible If this GMCH does not have internal graphics capability (CAPID0[46] = 1), then Device 2, Function 0 is disabled and hidden independent of the state of this bit. |
| 3 (82P45, 82P43 Only) | R/W/L | 1b | Core | Reserved |
| 2 | RO | 0b | Core | Reserved |
| 1 | R/W/L | 1b | Core | PCI Express Port (D1EN): 0 = Bus 0, Device 1, Function 0 is disabled and hidden. 1 = Bus 0, Device 1, Function 0 is enabled and visible. Default value is determined by the device capabilities (see CAPID0 [44]), SDVO Presence hardware strap and the sDVO/PCIe Concurrent hardware strap. Device 1 is Disabled on Reset if the SDVO Presence strap was sampled high, and the sDVO/PCIe Concurrent strap was sampled low at the last assertion of PWROK, and is enabled by default otherwise. |
| 0 | RO | 1b | Core | Host Bridge (D0EN): Bus 0, Device 0, Function 0 may not be disabled and is therefore hardwired to 1. |



5.1.16 PCIEXBAR—PCI Express Register Range Base Address

B/D/F/Type: 0/0/0/PCI
 Address Offset: 60-67h
 Default Value: 00000000E0000000h
 Access: RO, R/W/L, R/W/L/K
 Size: 64 bits

This is the base address for the PCI Express configuration space. This window of addresses contains the 4 KB of configuration space for each PCI Express device that can potentially be part of the PCI Express Hierarchy associated with the (G)MCH. There is not actual physical memory within this window of up to 256 MB that can be addressed. The actual length is determined by a field in this register. Each PCI Express Hierarchy requires a PCI Express BASE register. The (G)MCH supports one PCI Express hierarchy. The region reserved by this register does not alias to any PCI 2.3 compliant memory mapped space. For example MCHBAR reserves a 16 KB space and CHAPADR reserves a 4 KB space both outside of PCIEXBAR space. They cannot be overlaid on the space reserved by PCIEXBAR for devices 0 and 7 respectively.

On reset, this register is disabled and must be enabled by writing a 1 to the enable field in this register. This base address shall be assigned on a boundary consistent with the number of buses (defined by the Length field in this register), above TOLUD and still within 64 bit addressable memory space. All other bits not decoded are read only 0. The PCI Express Base Address cannot be less than the maximum address written to the Top of physical memory register (TOLUD). Software must ensure that these ranges do not overlap with known ranges located above TOLUD. Software must ensure that the sum of Length of enhanced configuration region + TOLUD + (other known ranges reserved above TOLUD) is not greater than the 64-bit addressable limit of 64 GB. In general system implementation and number of PCI/PCI express/PCI-X buses supported in the hierarchy will dictate the length of the region.

Note: All the bits in this register are locked in Intel TXT mode (82Q45/82Q43 GMCH only).

| Bit | Access | Default Value | RST/PWR | Description |
|-------|--------|---------------|---------|------------------------------------------------------------------------------------------------------------------------------------------------------------------------------------------------------------------------------------------------------------------------------------------------------------------------------------------------------------------------------------------------------------------------------------------------------------------------------------------------------------------------------------------------------------------------------------------------------------------------------------------------------------------------------------------------------------------------------------------------------------------------------------------------------------------------------------------------------------------------------------------------------------------------------------------------------------------------------------------------------------------------------------------------------------------------------------------------------------------------------------------------------------------------------------------------------------------------------------------------------------------------|
| 63:36 | RO | 0000000h | Core | Reserved |
| 35:28 | R/W/L | 0Eh | Core | <p>PCI Express Base Address (PCIEXBAR): This field corresponds to bits 35:28 of the base address for PCI Express enhanced configuration space. BIOS will program this register resulting in a base address for a contiguous memory address space; size is defined by bits 2:1 of this register.</p> <p>This Base address shall be assigned on a boundary consistent with the number of buses (defined by the Length field in this register) above TOLUD and still within 64-bit addressable memory space. The address bits decoded depend on the length of the region defined by this register.</p> <p>The address used to access the PCI Express configuration space for a specific device can be determined as follows: PCI Express Base Address + Bus Number * 1MB + Device Number * 32KB + Function Number * 4KB</p> <p>The address used to access the PCI Express configuration space for Device 1 in this component is: PCI Express Base Address + 0 * 1MB + 1 * 32KB + 0 * 4KB = PCI Express Base Address + 32KB.</p> <p>Remember that this address is the beginning of the 4 KB space that contains both the PCI compatible configuration space and the PCI Express extended configuration space.</p> |



| Bit | Access | Default Value | RST/ PWR | Description |
|------|---------|---------------|-------------|---------------------------------------------------------------------------------------------------------------------------------------------------------------------------------------------------------------------------------------------------------------------------------------------------------------------------------------------------------------------------------------------------------------------------------------------------------------------------------------------|
| 27 | R/W/L | 0b | Core | 128MB Base Address Mask (128ADMSK): This bit is either part of the PCI Express Base Address (R/W) or part of the Address Mask (RO, read 0b), depending on the value of bits 2:1 in this register. |
| 26 | R/W/L | 0b | Core | 64MB Base Address Mask (64ADMSK): This bit is either part of the PCI Express Base Address (R/W) or part of the Address Mask (RO, read 0b), depending on the value of bits 2:1 in this register. |
| 25:3 | RO | 000000h | Core | Reserved |
| 2:1 | R/W/L/K | 00b | Core | Length (LENGTH): This Field describes the length of this region. It provides the Enhanced Configuration Space Region/Buses Decoded 00 = 256 MB (buses 0–255). Bits 31:28 are decoded in the PCI Express Base Address Field 01 = 128 MB (Buses 0–127). Bits 31:27 are decoded in the PCI Express Base Address Field. 10 = 64 MB (Buses 0–63). Bits 31:26 are decoded in the PCI Express Base Address Field. 11 =Reserved |
| 0 | R/W/L | 0b | Core | PCIEXBAR Enable (PCIEXBAREN): 0 = The PCIEXBAR register is disabled. Memory read and write transactions proceed as if there were no PCIEXBAR register. PCIEXBAR bits 35:26 are R/W with no functionality behind them. 1 = The PCIEXBAR register is enabled. Memory read and write transactions whose address bits 35:26 match PCIEXBAR will be translated to configuration reads and writes within the (G)MCH. These Translated cycles are routed as shown in the table above. |



5.1.17 DMIBAR—Root Complex Register Range Base Address

B/D/F/Type: 0/0/0/PCI
 Address Offset: 68-6Fh
 Default Value: 0000000000000000h
 Access: RO, R/W/L
 Size: 64 bits

This is the base address for the Root Complex configuration space. This window of addresses contains the Root Complex Register set for the PCI Express Hierarchy associated with the (G)MCH. There is no physical memory within this 4 KB window that can be addressed. The 4 KB reserved by this register does not alias to any PCI 2.3 compliant memory mapped space. On reset, the Root Complex configuration space is disabled and must be enabled by writing a 1 to DMIBAREN [Dev 0, offset 68h, bit 0].

Note: All the bits in this register are locked in Intel TXT mode (82Q45/82Q43 GMCH only).

| Bit | Access | Default Value | RST/PWR | Description |
|-------|--------|---------------|---------|-----------------------------------------------------------------------------------------------------------------------------------------------------------------------------------------------------------------------------------------------------------------------------------------------------------------------------------------------------------------------------------------------------------------------------------------|
| 63:36 | RO | 0000000h | Core | Reserved |
| 35:12 | R/W/L | 000000h | Core | DMI Base Address (DMIBAR): This field corresponds to bits 35:12 of the base address DMI configuration space. BIOS will program this register resulting in a base address for a 4 KB block of contiguous memory address space. This register ensures that a naturally aligned 4 KB space is allocated within the first 64 GB of addressable memory space. System Software uses this base address to program the DMI register set. |
| 11:1 | RO | 000h | Core | Reserved |
| 0 | R/W/L | 0b | Core | DMIBAR Enable (DMIBAREN): 0 = DMIBAR is disabled and does not claim any memory 1 = DMIBAR memory mapped accesses are claimed and decoded appropriately |



5.1.18 PAM0—Programmable Attribute Map 0

B/D/F/Type: 0/0/0/PCI
 Address Offset: 90h
 Default Value: 00h
 Access: RO, R/W/L
 Size: 8 bits

This register controls the read, write, and shadowing attributes of the BIOS area from 0F0000h–0FFFFFFh. The (G)MCH allows programmable memory attributes on 13 Legacy memory segments of various sizes in the 768 KB to 1 MB address range. Seven Programmable Attribute Map (PAM) Registers are used to support these features. Cacheability of these areas is controlled via the MTRR registers in the processor. Two bits are used to specify memory attributes for each memory segment. These bits apply to both host accesses and PCI initiator accesses to the PAM areas. These attributes are:

- RE - Read Enable. When RE = 1, the processor read accesses to the corresponding memory segment are claimed by the (G)MCH and directed to main memory. Conversely, when RE = 0, the host read accesses are directed to PCI_A.
- WE - Write Enable. When WE = 1, the host write accesses to the corresponding memory segment are claimed by the (G)MCH and directed to main memory. Conversely, when WE = 0, the host write accesses are directed to PCI_A.

The RE and WE attributes permit a memory segment to be Read Only, Write Only, Read/Write, or disabled. For example, if a memory segment has RE = 1 and WE = 0, the segment is Read Only. Each PAM Register controls two regions, typically 16 KB in size.

Note that the (G)MCH may hang if a PCI Express Graphics Attach or DMI originated access to Read Disabled or Write Disabled PAM segments occur (due to a possible IWB to non-DRAM).

For these reasons, the following critical restriction is placed on the programming of the PAM regions: At the time that a DMI or PCI Express Graphics Attach accesses to the PAM region may occur, the targeted PAM segment must be programmed to be both readable and writeable.

Note: All the bits in this register are locked in Intel TXT mode (82Q45/82Q43 GMCH only).

| Bit | Access | Default Value | RST/PWR | Description |
|-----|--------|---------------|---------|-------------------------------------------------------------------------------------------------------------------------------------------------------------------------------------------------------------------------------------------------------------------------------------------------------------------------------------------------------------------------------------------------------------------------------------------------------------|
| 7:6 | RO | 00b | Core | Reserved |
| 5:4 | R/W/L | 00b | Core | 0F0000h-0FFFFFFh Attribute (HIENABLE): This field controls the steering of read and write cycles that address the BIOS area from 0F0000h to 0FFFFFFh. 00 = DRAM Disabled: All accesses are directed to DMI. 01 = Read Only: All reads are sent to DRAM. All writes are forwarded to DMI. 10 = Write Only: All writes are sent to DRAM. Reads are serviced by DMI. 11 = Normal DRAM Operation: All reads and writes are serviced by DRAM. |
| 3:0 | RO | 0h | Core | Reserved |



5.1.19 PAM1—Programmable Attribute Map 1

B/D/F/Type: 0/0/0/PCI
 Address Offset: 91h
 Default Value: 00h
 Access: RO, R/W/L
 Size: 8 bits

This register controls the read, write, and shadowing attributes of the BIOS areas from 0C0000h–0C7FFFh.

Note: All the bits in this register are locked in Intel TXT mode (82Q45/82Q43 GMCH only).

| Bit | Access | Default Value | RST/PWR | Description |
|-----|--------|---------------|---------|-----------------------------------------------------------------------------------------------------------------------------------------------------------------------------------------------------------------------------------------------------------------------------------------------------------------------------------------------------------------------------------------------------------------------------------------------------------|
| 7:6 | RO | 00b | Core | Reserved |
| 5:4 | R/W/L | 00b | Core | 0C4000h-0C7FFFh Attribute (HIENABLE): This field controls the steering of read and write cycles that address the BIOS area from 0C4000h to 0C7FFFh. 00 = DRAM Disabled: Accesses are directed to DMI. 01 = Read Only: All reads are serviced by DRAM. All writes are forwarded to DMI. 10 = Write Only: All writes are sent to DRAM. Reads are serviced by DMI. 11 = Normal DRAM Operation: All reads and writes are serviced by DRAM. |
| 3:2 | RO | 00b | Core | Reserved |
| 1:0 | R/W/L | 00b | Core | 0C0000h-0C3FFFh Attribute (LOENABLE): This field controls the steering of read and write cycles that address the BIOS area from 0C0000h to 0C3FFFh. 00 = DRAM Disabled: Accesses are directed to DMI. 01 = Read Only: All reads are serviced by DRAM. All writes are forwarded to DMI. 10 = Write Only: All writes are sent to DRAM. Reads are serviced by DMI. 11 = Normal DRAM Operation: All reads and writes are serviced by DRAM. |



5.1.20 PAM2—Programmable Attribute Map 2

B/D/F/Type: 0/0/0/PCI
Address Offset: 92h
Default Value: 00h
Access: RO, R/W/L
Size: 8 bits

This register controls the read, write, and shadowing attributes of the BIOS areas from 0C8000h–0CFFFFh.

Note: All the bits in this register are locked in Intel TXT mode (82Q45/82Q43 GMCH only).

| Bit | Access | Default Value | RST/ PWR | Description |
|-----|--------|---------------|-------------|-----------------------------------------------------------------------------------------------------------------------------------------------------------------------------------------------------------------------------------------------------------------------------------------------------------------------------------------------------------------------------------------------------------------------------------------------------------|
| 7:6 | RO | 00b | Core | Reserved |
| 5:4 | R/W/L | 00b | Core | 0CC000h-0CFFFFh Attribute (HIENABLE): 00 = DRAM Disabled: Accesses are directed to DMI. 01 = Read Only: All reads are serviced by DRAM. All writes are forwarded to DMI. 10 = Write Only: All writes are sent to DRAM. Reads are serviced by DMI. 11 = Normal DRAM Operation: All reads and writes are serviced by DRAM. |
| 3:2 | RO | 00b | Core | Reserved |
| 1:0 | R/W/L | 00b | Core | 0C8000h-0CBFFFh Attribute (LOENABLE): This field controls the steering of read and write cycles that address the BIOS area from 0C8000h to 0CBFFFh. 00 = DRAM Disabled: Accesses are directed to DMI. 01 = Read Only: All reads are serviced by DRAM. All writes are forwarded to DMI. 10 = Write Only: All writes are sent to DRAM. Reads are serviced by DMI. 11 = Normal DRAM Operation: All reads and writes are serviced by DRAM. |



5.1.21 PAM3—Programmable Attribute Map 3

B/D/F/Type: 0/0/0/PCI
 Address Offset: 93h
 Default Value: 00h
 Access: RO, R/W/L
 Size: 8 bits

This register controls the read, write, and shadowing attributes of the BIOS areas from 0D0000h–0D7FFFh.

Note: All the bits in this register are locked in Intel TXT mode (82Q45/82Q43 GMCH only).

| Bit | Access | Default Value | RST/PWR | Description |
|-----|--------|---------------|---------|-----------------------------------------------------------------------------------------------------------------------------------------------------------------------------------------------------------------------------------------------------------------------------------------------------------------------------------------------------------------------------------------------------------------------------------------------------------|
| 7:6 | RO | 00b | Core | Reserved |
| 5:4 | R/W/L | 00b | Core | 0D4000h-0D7FFFh Attribute (HIENABLE): This field controls the steering of read and write cycles that address the BIOS area from 0D4000 to 0D7FFF. 00 = DRAM Disabled: Accesses are directed to DMI. 01 = Read Only: All reads are serviced by DRAM. All writes are forwarded to DMI. 10 = Write Only: All writes are sent to DRAM. Reads are serviced by DMI. 11 = Normal DRAM Operation: All reads and writes are serviced by DRAM. |
| 3:2 | RO | 00b | Core | Reserved |
| 1:0 | R/W/L | 00b | Core | 0D0000h-0D3FFFh Attribute (LOENABLE): This field controls the steering of read and write cycles that address the BIOS area from 0D0000h to 0D3FFFh. 00 = DRAM Disabled: Accesses are directed to DMI. 01 = Read Only: All reads are serviced by DRAM. All writes are forwarded to DMI. 10 = Write Only: All writes are sent to DRAM. Reads are serviced by DMI. 11 = Normal DRAM Operation: All reads and writes are serviced by DRAM. |



5.1.22 PAM4—Programmable Attribute Map 4

B/D/F/Type: 0/0/0/PCI
 Address Offset: 94h
 Default Value: 00h
 Access: RO, R/W/L
 Size: 8 bits

This register controls the read, write, and shadowing attributes of the BIOS areas from 0D8000h–0DFFFFh.

Note: All the bits in this register are locked in Intel TXT mode (82Q45/82Q43 GMCH only).

| Bit | Access | Default Value | RST/PWR | Description |
|-----|--------|---------------|---------|-----------------------------------------------------------------------------------------------------------------------------------------------------------------------------------------------------------------------------------------------------------------------------------------------------------------------------------------------------------------------------------------------------------------------------------------------------------|
| 7:6 | RO | 00b | Core | Reserved |
| 5:4 | R/W/L | 00b | Core | 0DC000h-0DFFFFh Attribute (HIENABLE): This field controls the steering of read and write cycles that address the BIOS area from 0DC000h to 0DFFFFh. 00 = DRAM Disabled: Accesses are directed to DMI. 01 = Read Only: All reads are serviced by DRAM. All writes are forwarded to DMI. 10 = Write Only: All writes are sent to DRAM. Reads are serviced by DMI. 11 = Normal DRAM Operation: All reads and writes are serviced by DRAM. |
| 3:2 | RO | 00b | Core | Reserved |
| 1:0 | R/W/L | 00b | Core | 0D8000h-0DBFFFh Attribute (LOENABLE): This field controls the steering of read and write cycles that address the BIOS area from 0D8000h to 0DBFFFh. 00 = DRAM Disabled: Accesses are directed to DMI. 01 = Read Only: All reads are serviced by DRAM. All writes are forwarded to DMI. 10 = Write Only: All writes are sent to DRAM. Reads are serviced by DMI. 11 = Normal DRAM Operation: All reads and writes are serviced by DRAM. |



5.1.23 PAM5—Programmable Attribute Map 5

B/D/F/Type: 0/0/0/PCI
 Address Offset: 95h
 Default Value: 00h
 Access: RO, R/W/L
 Size: 8 bits

This register controls the read, write, and shadowing attributes of the BIOS areas from 0E0000h–0E7FFFh.

Note: All the bits in this register are locked in Intel TXT mode (82Q45/82Q43 GMCH only).

| Bit | Access | Default Value | RST/PWR | Description |
|-----|--------|---------------|---------|----------------------------------------------------------------------------------------------------------------------------------------------------------------------------------------------------------------------------------------------------------------------------------------------------------------------------------------------------------------------------------------------------------------------------------------------------------------------------------|
| 7:6 | RO | 00b | Core | Reserved |
| 5:4 | R/W/L | 00b | Core | <p>0E4000h-0E7FFFh Attribute (HIENABLE): This field controls the steering of read and write cycles that address the BIOS area from 0E4000h to 0E7FFFh.</p> <p>00 = DRAM Disabled: Accesses are directed to DMI.</p> <p>01 = Read Only: All reads are serviced by DRAM. All writes are forwarded to DMI.</p> <p>10 = Write Only: All writes are sent to DRAM. Reads are serviced by DMI.</p> <p>11 = Normal DRAM Operation: All reads and writes are serviced by DRAM.</p> |
| 3:2 | RO | 00b | Core | Reserved |
| 1:0 | R/W/L | 00b | Core | <p>0E0000-0E3FFF Attribute (LOENABLE): This field controls the steering of read and write cycles that address the BIOS area from 0E0000 to 0E3FFF.</p> <p>00 = DRAM Disabled: Accesses are directed to DMI.</p> <p>01 = Read Only: All reads are serviced by DRAM. All writes are forwarded to DMI.</p> <p>10 = Write Only: All writes are sent to DRAM. Reads are serviced by DMI.</p> <p>11 = Normal DRAM Operation: All reads and writes are serviced by DRAM.</p> |



5.1.24 PAM6—Programmable Attribute Map 6

B/D/F/Type: 0/0/0/PCI
 Address Offset: 96h
 Default Value: 00h
 Access: RO, R/W/L
 Size: 8 bits

This register controls the read, write, and shadowing attributes of the BIOS areas from 0E8000h–0EFFFFh.

Note: All the bits in this register are locked in Intel TXT mode (82Q45/82Q43 GMCH only).

| Bit | Access | Default Value | RST/PWR | Description |
|-----|--------|---------------|---------|-----------------------------------------------------------------------------------------------------------------------------------------------------------------------------------------------------------------------------------------------------------------------------------------------------------------------------------------------------------------------------------------------------------------------------------------------------------|
| 7:6 | RO | 00b | Core | Reserved |
| 5:4 | R/W/L | 00b | Core | 0EC000h-0EFFFFh Attribute (HIENABLE): This field controls the steering of read and write cycles that address the BIOS area from 0E4000h to 0E7FFFh. 00 = DRAM Disabled: Accesses are directed to DMI. 01 = Read Only: All reads are serviced by DRAM. All writes are forwarded to DMI. 10 = Write Only: All writes are sent to DRAM. Reads are serviced by DMI. 11 = Normal DRAM Operation: All reads and writes are serviced by DRAM. |
| 3:2 | RO | 00b | Core | Reserved |
| 1:0 | R/W/L | 00b | Core | 0E8000h-0EBFFFh Attribute (LOENABLE): This field controls the steering of read and write cycles that address the BIOS area from 0E0000h to 0E3FFFh. 00 = DRAM Disabled: Accesses are directed to DMI. 01 = Read Only: All reads are serviced by DRAM. All writes are forwarded to DMI. 10 = Write Only: All writes are sent to DRAM. Reads are serviced by DMI. 11 = Normal DRAM Operation: All reads and writes are serviced by DRAM. |



5.1.25 LAC—Legacy Access Control

B/D/F/Type: 0/0/0/PCI
 Address Offset: 97h
 Default Value: 00h
 Access: R/W, R/W/L, RO
 Size: 8 bits

This 8-bit register controls a fixed DRAM hole from 15–16 MB.

| Bit | Access | Default Value | RST/ PWR | Description |
|-------------------------------------------------------------------------|--------|---------------|-------------|-------------------------------------------------------------------------------------------------------------------------------------------------------------------------------------------------------------------------------------------------------------|
| 7 | R/W/L | 0b | Core | Hole Enable (HEN): This field enables a memory hole in DRAM space. The DRAM that lies "behind" this space is not remapped. 0 = No memory hole. 1 = Memory hole from 15 MB to 16 MB. This bit is Intel TXT lockable (82Q45/82Q43 GMCH only). |
| 6:2 | RO | 00h | Core | Reserved |
| 1 (82P45 MCH only) | R/W | 0b | Core | PEG1 MDA Present (MDAP1): Definition of this bit is the same as for the adjacent PEG0 MDA Present bit except for all references to Device 1 are replaced with Device 6. |
| 1 (82Q45, 82Q43, 82B43, 82G45, 82G43, 82G41 GMCH and 82P43 MCH only) | R/W | 0b | Core | Reserved |



| Bit | Access | Default Value | RST/ PWR | Description | | | | | | | | | | | | | | | |
|-------|--------|-------------------------------------------------------------------------------------------------|-------------|--------------------------------------------------------------------------------------------------------------------------------------------------------------------------------------------------------------------------------------------------------------------------------------------------------------------------------------------------------------------------------------------------------------------------------------------------------------------------------------------------------------------------------------------------------------------------------------------------------------------------------------------------------------------------------------------------------------------------------------------------------------------------------------------------------------------------------------------------------------------------------------------------------------------------------------------------------------------------------------------------------------------------------------------------------------------------------------------------------------------------------------------------------------------------------------------------------------------------------------------------------------------------------------------------------------------------------------------------------------------------------------------------------------------------------------------------------------------------------------------------------------------------------------------------------------------------------------------------------------------------------------------------------------------------------------------------------------------------------------------------------------------------------------------------------------------------------------------------------------------------------------------------------|-------|------|-------------|---|---|-------------------------------------------------------|---|---|---------------------|---|---|-----------------------------------------------------------------------|---|---|-------------------------------------------------------------------------------------------------|
| 0 | R/W | 0b | Core | <p>PEGO MDA Present (MDAP0): This bit works with the VGA Enable bits in the BCTRL register of Device 1 to control the routing of processor-initiated transactions targeting MDA compatible I/O and memory address ranges. This bit should not be set if device 1's VGA Enable bit is not set.</p> <p>If device 1's VGA enable bit is not set, then accesses to I/O address range x3BCh–x3BFh are forwarded to DMI. If the VGA enable bit is set and MDA is not present, then accesses to IO address range x3BCh–x3BFh are forwarded to PCI Express if the address is within the corresponding IOBASE and IOLIMIT, otherwise they are forwarded to DMI.</p> <p>MDA resources are defined as the following: Memory: 0B0000h–0B7FFFh I/O: 3B4h, 3B5h, 3B8h, 3B9h, 3BAh, 3BFh, (including ISA address aliases, A[15:10] are not used in decode)</p> <p>Any I/O reference that includes the I/O locations listed above, or their aliases, will be forwarded to the DMI even if the reference includes I/O locations not listed above.</p> <p>The following table shows the behavior for all combinations of MDA and VGA:</p> <table border="1"> <thead> <tr> <th>VGAEN</th> <th>MDAP</th> <th>Description</th> </tr> </thead> <tbody> <tr> <td>0</td> <td>0</td> <td>All References to MDA and VGA space are routed to DMI</td> </tr> <tr> <td>0</td> <td>1</td> <td>invalid combination</td> </tr> <tr> <td>1</td> <td>0</td> <td>All VGA and MDA references are routed to PCI Express Graphics Attach.</td> </tr> <tr> <td>1</td> <td>1</td> <td>All VGA references are routed to PCI Express Graphics Attach. MDA references are routed to DMI.</td> </tr> </tbody> </table> <p>VGA and MDA memory cycles can only be routed across the PEG when MAE (PCICMD1[1]) is set. VGA and MDA I/O cycles can only be routed across the PEG if IOAE (PCICMD1[0]) is set.</p> | VGAEN | MDAP | Description | 0 | 0 | All References to MDA and VGA space are routed to DMI | 0 | 1 | invalid combination | 1 | 0 | All VGA and MDA references are routed to PCI Express Graphics Attach. | 1 | 1 | All VGA references are routed to PCI Express Graphics Attach. MDA references are routed to DMI. |
| VGAEN | MDAP | Description | | | | | | | | | | | | | | | | | |
| 0 | 0 | All References to MDA and VGA space are routed to DMI | | | | | | | | | | | | | | | | | |
| 0 | 1 | invalid combination | | | | | | | | | | | | | | | | | |
| 1 | 0 | All VGA and MDA references are routed to PCI Express Graphics Attach. | | | | | | | | | | | | | | | | | |
| 1 | 1 | All VGA references are routed to PCI Express Graphics Attach. MDA references are routed to DMI. | | | | | | | | | | | | | | | | | |



5.1.26 REMAPBASE—Remap Base Address Register

B/D/F/Type: 0/0/0/PCI
 Address Offset: 98-99h
 Default Value: 03FFh
 Access: RO, R/W/L
 Size: 16 bits

| Bit | Access | Default Value | RST/PWR | Description |
|-------|--------|---------------|---------|---------------------------------------------------------------------------------------------------------------------------------------------------------------------------------------------------------------------------------------------------------------------------------------------------------------------------------------------------------------------------------------------------------------------------------------------------------------------------------------------------------------------------------------------------------------------------------|
| 15:10 | RO | 000000b | Core | Reserved |
| 9:0 | R/W/L | 3FFh | Core | <p>Remap Base Address [35:26] (REMAPBASE): The value in this register defines the lower boundary of the Remap window. The Remap window is inclusive of this address. In the decoder A[25:0] of the Remap Base Address are assumed to be 0s. Thus the bottom of the defined memory range will be aligned to a 64 MB boundary.</p> <p>When the value in this register is greater than the value programmed into the Remap Limit register, the Remap window is disabled.</p> <p>These bits are Intel TXT lockable (82Q45/82Q43 GMCH only) or ME stolen Memory lockable.</p> |

5.1.27 REMAPLIMIT—Remap Limit Address Register

B/D/F/Type: 0/0/0/PCI
 Address Offset: 9A-9Bh
 Default Value: 0000h
 Access: RO, R/W/L
 Size: 16 bits

| Bit | Access | Default Value | RST/PWR | Description |
|-------|--------|---------------|---------|-----------------------------------------------------------------------------------------------------------------------------------------------------------------------------------------------------------------------------------------------------------------------------------------------------------------------------------------------------------------------------------------------------------------------------------------------------------------------------------------------------------------------------------------------------------------------|
| 15:10 | RO | 000000b | Core | Reserved |
| 9:0 | R/W/L | 000h | Core | <p>Remap Limit Address [35:26] (REMAPLMT): The value in this register defines the upper boundary of the Remap window. The Remap window is inclusive of this address. In the decoder A[25:0] of the remap limit address are assumed to be Fh. Thus the top of the defined range will be one less than a 64 MB boundary.</p> <p>When the value in this register is less than the value programmed into the Remap Base register, the Remap window is disabled.</p> <p>These Bits are Intel TXT lockable (82Q45/82Q43 GMCH only) or ME stolen Memory lockable.</p> |



5.1.28 SMRAM—System Management RAM Control

B/D/F/Type: 0/0/0/PCI
 Address Offset: 9Dh
 Default Value: 02h
 Access: RO, R/W/L, R/W, R/W/L/K
 Size: 8 bits

The SMRAMC register controls how accesses to Compatible and Extended SMRAM spaces are treated. The Open, Close, and Lock bits function only when G_SMRAME bit is set to a 1. Also, the OPEN bit must be reset before the LOCK bit is set.

| Bit | Access | Default Value | RST/PWR | Description |
|-----|---------|---------------|---------|---------------------------------------------------------------------------------------------------------------------------------------------------------------------------------------------------------------------------------------------------------------------------------------------------------------------------------------------------------------------------------------------------------------------------------------------------------------------------------------------------------------------------------------------------------------------------------------------------------------------------|
| 7 | RO | 0b | Core | Reserved |
| 6 | R/W/L | 0b | Core | SMM Space Open (D_OPEN): When D_OPEN=1 and D_LCK=0, the SMM space DRAM is made visible even when SMM decode is not active. This is intended to help BIOS initialize SMM space. Software should ensure that D_OPEN=1 and D_CLS=1 are not set at the same time. |
| 5 | R/W | 0b | Core | SMM Space Closed (D_CLS): When D_CLS = 1 SMM space DRAM is not accessible to data references, even if SMM decode is active. Code references may still access SMM space DRAM. This will allow SMM software to reference through SMM space to update the display even when SMM is mapped over the VGA range. Software should ensure that D_OPEN=1 and D_CLS=1 are not set at the same time. |
| 4 | R/W/L/K | 0b | Core | SMM Space Locked (D_LCK): When D_LCK is set to 1 then D_OPEN is reset to 0 and D_LCK, D_OPEN, C_BASE_SEG, H_SMRAM_EN, TSEG_SZ and TSEG_EN become read only. D_LCK can be set to 1 via a normal configuration space write but can only be cleared by a Full Reset. The combination of D_LCK and D_OPEN provide convenience with security. The BIOS can use the D_OPEN function to initialize SMM space and then use D_LCK to "lock down" SMM space in the future so that no application software (or BIOS itself) can violate the integrity of SMM space, even if the program has knowledge of the D_OPEN function. |
| 3 | R/W/L | 0b | Core | Global SMRAM Enable (G_SMRAME): If set to a 1, then Compatible SMRAM functions are enabled, providing 128 KB of DRAM accessible at the A0000h address while in SMM (ADSB with SMM decode). To enable Extended SMRAM function this bit has be set to 1. Refer to the section on SMM for more details. Once D_LCK is set, this bit becomes read only. |
| 2:0 | RO | 010b | Core | Compatible SMM Space Base Segment (C_BASE_SEG): This field indicates the location of SMM space. SMM DRAM is not remapped. It is simply made visible if the conditions are right to access SMM space, otherwise the access is forwarded to DMI. Since the (G)MCH supports only the SMM space between A0000h and BFFFFh, this field is hardwired to 010b. |



5.1.29 ESMRAMC—Extended System Management RAM Control

B/D/F/Type: 0/0/0/PCI
 Address Offset: 9Eh
 Default Value: 38h
 Access: R/W/L, R/WC, RO
 Size: 8 bits

The Extended SMRAM register controls the configuration of Extended SMRAM space. The Extended SMRAM (E_SMRAM) memory provides a write-back cacheable SMRAM memory space that is above 1 MB.

| Bit | Access | Default Value | RST/PWR | Description |
|-----|--------|---------------|---------|-----------------------------------------------------------------------------------------------------------------------------------------------------------------------------------------------------------------------------------------------------------------------------------------------------------------------------------------------------------------------------------------|
| 7 | R/W/L | 0b | Core | Enable High SMRAM (H_SMRAME): Controls the SMM memory space location (i.e., above 1 MB or below 1 MB) When G_SMRAME is 1 and H_SMRAME is set to 1, the high SMRAM memory space is enabled. SMRAM accesses within the range 0FEDA0000h to 0FEDBFFFFh are remapped to DRAM addresses within the range 000A0000h to 000BFFFFh. Once D_LCK has been set, this bit becomes read only. |
| 6 | R/WC | 0b | Core | Invalid SMRAM Access (E_SMERR): This bit is set when the processor has accessed the defined memory ranges in Extended SMRAM (High Memory and T-segment) while not in SMM space and with the D-OPEN bit = 0. It is software's responsibility to clear this bit. The software must write a 1 to this bit to clear it. |
| 5 | RO | 1b | Core | SMRAM Cacheable (SM_CACHE): This bit is forced to 1 by the (G)MCH. |
| 4 | RO | 1b | Core | L1 Cache Enable for SMRAM (SM_L1): This bit is forced to 1 by the (G)MCH. |
| 3 | RO | 1b | Core | L2 Cache Enable for SMRAM (SM_L2): This bit is forced to 1 by the (G)MCH. |



| Bit | Access | Default Value | RST/PWR | Description |
|-----|--------|---------------|---------|--------------------------------------------------------------------------------------------------------------------------------------------------------------------------------------------------------------------------------------------------------------------------------------------------------------------------------------------------------------------------------------------------------------------------------------------------------------------------------------------------------------------------------------------------------------------------------------------------------------------------------------------------------------------------------------------------------------------------------------------------------------------------------------------------------------------------------------------------------------------------------------------------------------------------------------------------------------|
| 2:1 | R/W/L | 00b | Core | <p>TSEG Size (TSEG_SZ): Selects the size of the TSEG memory block if enabled. Memory from the top of DRAM space is partitioned away so that it may only be accessed by the processor interface and only then when the SMM bit is set in the request packet. Non-SMM accesses to this memory region are sent to DMI when the TSEG memory block is enabled.</p> <p>00 = 1 MB TSEG. (TOLUD – GTT Graphics Memory Size – Graphics Stolen Memory Size – 1M) to (TOLUD – GTT Graphics Memory Size – Graphics Stolen Memory Size).</p> <p>01 = 2 MB TSEG (TOLUD – GTT Graphics Memory Size – Graphics Stolen Memory Size – 2M) to (TOLUD – GTT Graphics Memory Size – Graphics Stolen Memory Size).</p> <p>10 = 8 MB TSEG (TOLUD – GTT Graphics Memory Size – Graphics Stolen Memory Size – 8M) to (TOLUD – GTT Graphics Memory Size – Graphics Stolen Memory Size).</p> <p>11 = Reserved.</p> <p>Once D_LCK has been set, these bits becomes read only.</p> |
| 0 | R/W/L | 0b | Core | <p>TSEG Enable (T_EN): Enabling of SMRAM memory for Extended SMRAM space only. When G_SMFRAME = 1 and TSEG_EN = 1, the TSEG is enabled to appear in the appropriate physical address space. Note that once D_LCK is set, this bit becomes read only.</p> |

5.1.30 TOM—Top of Memory

B/D/F/Type: 0/0/0/PCI
 Address Offset: A0-A1h
 Default Value: 0001h
 Access: RO, R/W/L
 Size: 16 bits

This Register contains the size of physical memory. BIOS determines the memory size reported to the OS using this Register.

Note: All the bits in this register are locked in Intel TXT mode (82Q45/82Q43 GMCH only).

| Bit | Access | Default Value | RST/PWR | Description |
|-------|--------|---------------|---------|------------------------------------------------------------------------------------------------------------------------------------------------------------------------------------------------------------------------------------------------------------------------------------------------------------------------------------------------------------------------------------------------------------------------------------------------------------------------------|
| 15:10 | RO | 00h | Core | Reserved |
| 9:0 | R/W/L | 001h | Core | <p>Top of Memory (TOM): This register reflects the total amount of populated physical memory. This is NOT necessarily the highest main memory address (holes may exist in main memory address map due to addresses allocated for memory-mapped I/O). These bits correspond to address bits 35:26 (64 MB granularity). Bits 25:0 are assumed to be 0.</p> <p>The (G)MCH determines the base of EP stolen memory by subtracting the EP stolen memory size from TOM.</p> |



5.1.31 TOUUD—Top of Upper Usable DRAM

B/D/F/Type: 0/0/0/PCI
 Address Offset: A2-A3h
 Default Value: 0000h
 Access: R/W/L
 Size: 16 bits

This 16 bit register defines the Top of Upper Usable DRAM.

Configuration software must set this value to TOM minus all EP stolen memory if reclaim is disabled. If reclaim is enabled, this value must be set to reclaim limit + 1byte 64 MB aligned since reclaim limit is 64M B aligned. Address bits 19:0 are assumed to be 000_0000h for the purposes of address comparison. The Host interface positively decodes an address towards DRAM if the incoming address is less than the value programmed in this register and greater than or equal to 4 B.

Note: All the bits in this register are locked in Intel TXT mode (82Q45/82Q43 GMCH only).

| Bit | Access | Default Value | RST/PWR | Description |
|------|--------|---------------|---------|--------------------------------------------------------------------------------------------------------------------------------------------------------------------------------------------------------------------------------------------------------------------------------------------------------------------------------------------------------------------------------------------------------------------------------------------------------------------------------------------------------------------------------------------------------------------------------------------------------------------------------------------------------|
| 15:0 | R/W/L | 0000h | Core | TOUUD (TOUUD): This register contains bits 35:20 of an address one byte above the maximum DRAM memory above 4 GB that is usable by the operating system. Configuration software must set this value to TOM minus all EP stolen memory, if reclaim is disabled. If reclaim is enabled, this value must be set to reclaim limit 64 MB aligned since reclaim limit + 1byte is 64 MB aligned. Address bits 19:0 are assumed to be 000_0000h for the purposes of address comparison. The Host interface positively decodes an address towards DRAM if the incoming address is less than the value programmed in this register and greater than 4 GB. |



5.1.32 GBSM—Graphics Base of Stolen Memory (Intel® 82Q45, 82Q43, 82B43, 82G45, 82G43, 82G41 GMCH Only)

B/D/F/Type: 0/0/0/PCI
 Address Offset: A4-A7h
 Default Value: 00000000h
 Access: R/W/L, RO
 Size: 32 bits

This register contains the base address of graphics data stolen DRAM memory. BIOS determines the base of graphics data stolen memory by subtracting the graphics data stolen memory size (PCI Device 0, offset 52h, bits 6:4) from TOLUD (PCI Device 0, offset B0h, bits 15:4).

Note: This register is locked and becomes Read Only when the D_LCK bit in the SMRAM register is set.

| Bit | Access | Default Value | RST/PWR | Description |
|-------|--------|---------------|---------|-----------------------------------------------------------------------------------------------------------------------------------------------------------------------------------------------------------------------------------------------------------------------------------------------------------------------------------------------------------------------------------------------------------------------------------------------|
| 31:20 | R/W/L | 000h | Core | <p>Graphics Base of Stolen Memory (GBSM): This register contains bits 31:20 of the base address of stolen DRAM memory. BIOS determines the base of graphics stolen memory by subtracting the graphics stolen memory size (PCI Device 0, offset 52h, bits 6:4) from TOLUD (PCI Device 0, offset B0h, bits 15:4).</p> <p>NOTE: This register is locked and becomes Read Only when the D_LCK bit in the SMRAM register is set.</p> |
| 19:0 | RO | 00000h | Core | Reserved |

5.1.33 BGSM—Base of GTT stolen Memory (Intel® 82Q45, 82Q43, 82B43, 82G45, 82G43, 82G41 GMCH Only)

B/D/F/Type: 0/0/0/PCI
 Address Offset: A8-ABh
 Default Value: 00000000h
 Access: R/W/L, RO
 Size: 32 bits

This register contains the base address of stolen DRAM memory for the GTT. BIOS determines the base of GTT stolen memory by subtracting the GTT graphics stolen memory size (PCI Device 0, offset 52h, bits 9:8) from the graphics stolen memory base (PCI Device 0, offset A4h, bits 31:20).

Note: This register is locked and becomes Read Only when the D_LCK bit in the SMRAM register is set.

| Bit | Access | Default Value | RST/PWR | Description |
|-------|--------|---------------|---------|--------------------------------------------------------------------------------------------------------------------------------------------------------------------------------------------------------------------------------------------------------------------------------------------------------------------------------------------------------------------------------------------------------------------------------------------------------------------------|
| 31:20 | R/W/L | 000h | Core | <p>Graphics Base of Stolen Memory (GBSM): This register contains bits 31:20 of the base address of stolen DRAM memory. BIOS determines the base of graphics stolen memory by subtracting the graphics stolen memory size (PCI Device 0, offset 52h, bits 9:8) from the graphics stolen memory base (PCI Device 0, offset A4h, bits 31:20).</p> <p>NOTE: This register is locked and becomes Read Only when the D_LCK bit in the SMRAM register is set.</p> |
| 19:0 | RO | 00000h | Core | Reserved |



5.1.34 TSEGMB—TSEG Memory Base

B/D/F/Type: 0/0/0/PCI
 Address Offset: AC-AFh
 Default Value: 00000000h
 Access: RO, R/W/L
 Size: 32 bits

This register contains the base address of TSEG DRAM memory. BIOS determines the base of TSEG memory by subtracting the TSEG size (PCI Device 0, offset 9Eh, bits 2:1) from graphics GTT stolen base (PCI Device 0, offset A8h, bits 31:20).

Once D_LCK has been set, these bits becomes read only.

| Bit | Access | Default Value | RST/PWR | Description |
|-------|--------|---------------|---------|--------------------------------------------------------------------------------------------------------------------------------------------------------------------------------------------------------------------------------------------------------------------------------------------------------------------------------------------------------|
| 31:20 | R/W/L | 000h | Core | TSEG Memory base (TSEGMB): This register contains bits 31:20 of the base address of TSEG DRAM memory. BIOS determines the base of TSEG memory by subtracting the TSEG size (PCI Device 0, offset 9Eh, bits 2:1) from graphics GTT stolen base (PCI Device 0, offset A8h, bits 31:20). Once D_LCK has been set, these bits becomes read only. |
| 19:0 | RO | 00000h | Core | Reserved |

5.1.35 TOLUD—Top of Low Usable DRAM

B/D/F/Type: 0/0/0/PCI
 Address Offset: B0-B1h
 Default Value: 0010h
 Access: R/W/L, RO
 Size: 16 bits

This 16 bit register defines the Top of Low Usable DRAM. TSEG, GTT Graphics memory and Graphics Stolen Memory are within the DRAM space defined. From the top, (G)MCH optionally claims 1 to 64 MB of DRAM for internal graphics if enabled, 1, 2 MB of DRAM for GTT Graphics Stolen Memory (if enabled) and 1, 2, or 8 MB of DRAM for TSEG if enabled.

Programming Example:

C1DRB3 is set to 4 GB

TSEG is enabled and TSEG size is set to 1 MB

Internal Graphics is enabled, and Graphics Mode Select is set to 32 MB

GTT Graphics Stolen Memory Size set to 2 MB

BIOS knows the operating system requires 1 GB of PCI space.

BIOS also knows the range from FEC0_0000h to FFFF_FFFFh is not usable by the system. This 20 MB range at the very top of addressable memory space is lost to APIC and Intel TXT (82Q45/82Q43 GMCH only).

According to the above equation, TOLUD is originally calculated to:

$$4 \text{ GB} = 1_0000_0000\text{h}$$

The system memory requirements are: 4 GB (max addressable space) – 1 GB (PCI space) – 35 MB (lost memory) = 3 GB – 35 MB (minimum granularity) = EC80_0000h.



Since ECBO_0000h (PCI and other system requirements) is less than 1_0000_0000h, TOLUD should be programmed to ECBh.

Note: All the bits in this register are locked in Intel TXT mode (82Q45/82Q43 GMCH only).

| Bit | Access | Default Value | RST/PWR | Description |
|------|--------|---------------|---------|------------------------------------------------------------------------------------------------------------------------------------------------------------------------------------------------------------------------------------------------------------------------------------------------------------------------------------------------------------------------------------------------------------------------------------------------------------------------------------------------------------------------------------------------------------------------------------------------------------------------------------------------------------------------------------------------------------------------------------------------------------------------------------------------------------------------------------------------------------------------------------------------------------------------------------------------------------------------------------------------------------------------------------------------------------|
| 15:4 | R/W/L | 001h | Core | Top of Low Usable DRAM (TOLUD): This register contains bits 31:20 of an address one byte above the maximum DRAM memory below 4 GB that is usable by the operating system. Address bits 31:20 programmed to 01h implies a minimum memory size of 1 MB. Configuration software must set this value to the smaller of the following 2 choices: maximum amount memory in the system minus ME stolen memory plus one byte or the minimum address allocated for PCI memory. Address bits 19:0 are assumed to be 0_0000h for the purposes of address comparison. The Host interface positively decodes an address towards DRAM if the incoming address is less than the value programmed in this register. Note that the Top of Low Usable DRAM is the lowest address above both Graphics Stolen memory and TSEG. BIOS determines the base of Graphics Stolen Memory by subtracting the Graphics Stolen Memory Size from TOLUD and further decrements by TSEG size to determine base of TSEG. This register must be 64 MB aligned when reclaim is enabled. |
| 3:0 | RO | 0000b | Core | Reserved |

5.1.36 ERRSTS—Error Status

B/D/F/Type: 0/0/0/PCI
 Address Offset: C8-C9h
 Default Value: 0000h
 Access: RO, R/WC/S
 Size: 16 bits

This register is used to report various error conditions via the SERR DMI messaging mechanism. An SERR DMI message is generated on a zero to one transition of any of these flags (if enabled by the ERRCMD and PCICMD registers).

These bits are set regardless of whether or not the SERR is enabled and generated. After the error processing is complete, the error logging mechanism can be unlocked by clearing the appropriate status bit by software writing a 1 to it.



| Bit | Access | Default Value | RST/PWR | Description |
|-------|--------|---------------|---------|--------------------------------------------------------------------------------------------------------------------------------------------------------------------------------------------------------------------------------------------------------------------------------------------------------------------------------------------------------------------------------------------------------------------------------------------------------------------------------------------------------------------------------------------------------------------------------------------------------------------------------------------------------------------------------------------------------------------------------------------------------------------------------------------|
| 15:13 | RO | 000b | Core | Reserved |
| 12 | R/WC/S | 0b | Core | (G)MCH Software Generated Event for SMI (GSGESMI): This indicates the source of the SMI was a Device 2 Software Event. |
| 11 | R/WC/S | 0b | Core | (G)MCH Thermal Sensor Event for SMI/SCI/SERR (GTSE): This bit indicates that a (G)MCH Thermal Sensor trip has occurred and an SMI, SCI, or SERR has been generated. The status bit is set only if a message is sent based on Thermal event enables in Error command, SMI command and SCI command registers. A trip point can generate one of SMI, SCI, or SERR interrupts (two or more per event is invalid). Multiple trip points can generate the same interrupt, if software chooses this mode, subsequent trips may be lost. If this bit is already set, then an interrupt message will not be sent on a new thermal sensor event. |
| 10 | RO | 0b | Core | Reserved |
| 9 | R/WC/S | 0b | Core | LOCK to non-DRAM Memory Flag (LCKF): When this bit is set to 1, the (G)MCH has detected a lock operation to memory space that did not map into DRAM. |
| 8 | RO | 0b | Core | Received Refresh Timeout Flag (RRTOF): Reserved |
| 7 | R/WC/S | 0b | Core | DRAM Throttle Flag (DTF): 1 = Indicates that a DRAM Throttling condition occurred. 0 = Software has cleared this flag since the most recent throttling event. |
| 6:2 | RO | 00h | Core | Reserved |
| 1 | R/WC/S | 0b | Core | Multiple-bit DRAM ECC Error Flag (DMERR): If this bit is set to 1, a memory read data transfer had an uncorrectable multiple-bit error. When this bit is set the address, channel number, and device number that caused the error are logged in the DEAP register. Once this bit is set, the DEAP, DERRSYN, and DERRDST fields are locked until the processor clears this bit by writing a 1. Software uses bits [1:0] to detect whether the logged error address is for Single or Multiple-bit error. This bit is reset on PWROK. |
| 0 | R/WC/S | 0b | Core | Single-bit DRAM ECC Error Flag (DSERR): If this bit is set to 1, a memory read data transfer had a single-bit correctable error and the corrected data was sent for the access. When this bit is set, the address and device number that caused the error are logged in the DEAP register. Once this bit is set, the DEAP, DERRSYN, and DERRDST fields are locked to further single bit error updates until the processor clears this bit by writing a 1. A multiple bit error that occurs after this bit is set will overwrite the DEAP and DERRSYN fields with the multiple-bit error signature and the DMERR bit will also be set. A single bit error that occurs after a multi-bit error will set this bit but will not overwrite the other fields. This bit is reset on PWROK. |



5.1.37 ERRCMD—Error Command

B/D/F/Type: 0/0/0/PCI
 Address Offset: CA-CBh
 Default Value: 0000h
 Access: R/W, RO
 Size: 16 bits

This register controls the (G)MCH responses to various system errors. Since the (G)MCH does not have an SERRB signal, SERR messages are passed from the (G)MCH to the ICH over DMI.

When a bit in this register is set, a SERR message will be generated on DMI whenever the corresponding flag is set in the ERRSTS register. The actual generation of the SERR message is globally enabled for Device 0 via the PCI Command register.

| Bit | Access | Default Value | RST/PWR | Description |
|-------|--------|---------------|---------|-------------------------------------------------------------------------------------------------------------------------------------------------------------------------------------------------------------------------------------------------------------------------------------------------------------|
| 15:12 | RO | 0h | Core | Reserved |
| 11 | R/W | 0b | Core | SERR on (G)MCH Thermal Sensor Event (TSESERR): 1 = The (G)MCH generates a DMI SERR special cycle when bit 11 of the ERRSTS is set. The SERR must not be enabled at the same time as the SMI for the same thermal sensor event. 0 = Reporting of this condition via SERR messaging is disabled. |
| 10 | RO | 0b | Core | Reserved |
| 9 | R/W | 0b | Core | SERR on LOCK to non-DRAM Memory (LCKERR): 1 = The (G)MCH will generate a DMI SERR special cycle whenever a processor lock cycle is detected that does not hit DRAM. 0 = Reporting of this condition via SERR messaging is disabled. |
| 8 | R/W | 0b | Core | SERR on DRAM Refresh Timeout (DRTOERR): 1 = The (G)MCH generates a DMI SERR special cycle when a DRAM Refresh timeout occurs. 0 = Reporting of this condition via SERR messaging is disabled. |
| 7 | R/W | 0b | Core | SERR on DRAM Throttle Condition (DTCERR): 1 = The (G)MCH generates a DMI SERR special cycle when a DRAM Read or Write Throttle condition occurs. 0 = Reporting of this condition via SERR messaging is disabled. |
| 6:2 | RO | 00h | Core | Reserved |
| 1 | R/W | 0b | Core | SERR Multiple-Bit DRAM ECC Error (DMERR): 1 = The (G)MCH generates a SERR message over DMI when it detects a multiple-bit error reported by the DRAM controller. 0 = Reporting of this condition via SERR messaging is disabled. For systems not supporting ECC, this bit must be disabled. |
| 0 | R/W | 0b | Core | SERR on Single-bit ECC Error (DSERR): 1 = The (G)MCH generates a SERR special cycle over DMI when the DRAM controller detects a single bit error. 0 = Reporting of this condition via SERR messaging is disabled. For systems that do not support ECC, this bit must be disabled. |



5.1.38 SMICMD—SMI Command

B/D/F/Type: 0/0/0/PCI
 Address Offset: CC-CDh
 Default Value: 0000h
 Access: RO, R/W
 Size: 16 bits

This register enables various errors to generate an SMI DMI special cycle. When an error flag is set in the ERRSTS register, it can generate an SERR, SMI, or SCI DMI special cycle when enabled in the ERRCMD, SMICMD, or SCICMD registers, respectively. Note that one and only one message type can be enabled.

| Bit | Access | Default Value | RST/PWR | Description |
|-------|--------|---------------|---------|------------------------------------------------------------------------------------------------------------------------------------------------------------------------------------------------------------------------------------------------------------------------------------------------------|
| 15:12 | RO | 0h | Core | Reserved |
| 11 | R/W | 0b | Core | SMI on (G)MCH Thermal Sensor Trip (TSTSMI): 1 = A SMI DMI special cycle is generated by (G)MCH when the thermal sensor trip requires an SMI. A thermal sensor trip point cannot generate more than one special cycle. 0 = Reporting of this condition via SMI messaging is disabled. |
| 10:2 | RO | 000h | Core | Reserved |
| 1 | R/W | 0b | Core | SMI on Multiple-Bit DRAM ECC Error (DMESMI): 1 = The (G)MCH generates an SMI DMI message when it detects a multiple-bit error reported by the DRAM controller. 0 = Reporting of this condition via SMI messaging is disabled. For systems not supporting ECC this bit must be disabled. |
| 0 | R/W | 0b | Core | SMI on Single-bit ECC Error (DSESMI): 1 = The (G)MCH generates an SMI DMI special cycle when the DRAM controller detects a single bit error. 0 = Reporting of this condition via SMI messaging is disabled. For systems that do not support ECC this bit must be disabled. |

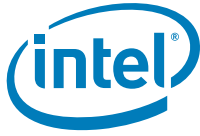

5.1.39 SKPD—Scratchpad Data

B/D/F/Type: 0/0/0/PCI
 Address Offset: DC-DFh
 Default Value: 00000000h
 Access: R/W
 Size: 32 bits

This register holds 32 writable bits with no functionality behind them. It is for the convenience of BIOS and graphics drivers.

| Bit | Access | Default Value | RST/PWR | Description |
|------|--------|---------------|---------|---------------------------------------------------------|
| 31:0 | R/W | 00000000h | Core | Scratchpad Data (SKPD): 1 DWord of data storage. |

5.1.40 CAPID0—Capability Identifier

B/D/F/Type: 0/0/0/PCI
 Address Offset: E0-ECh
 Default Value: 00000000000000000000000010C0009h
 Access: RO
 Size: 104 bits
 BIOS Optimal Default 0h

| Bit | Access | Default Value | RST/PWR | Description |
|--------|--------|---------------|---------|----------------------------------------------------------------------------------------------------------------------------------------------------------------|
| 103:28 | RO | 0000b | Core | Reserved |
| 27:24 | RO | 1h | Core | CAPID Version (CAPI DV): This field has the value 0001b to identify the first revision of the CAPID register definition. |
| 23:16 | RO | 0Ch | Core | CAPID Length (CAPI DL): This field has the value 0Ch to indicate the structure length (12 bytes). |
| 15:8 | RO | 00h | Core | Next Capability Pointer (NCP): This field is hardwired to 00h indicating the end of the capabilities linked list. |
| 7:0 | RO | 09h | Core | Capability Identifier (CAP_ID): This field has the value 1001b to identify the CAP_ID assigned by the PCI SIG for vendor dependent capability pointers. |



5.2 MCHBAR

| Address Offset | Register Symbol | Register Name | Default Value | Access |
|----------------|-----------------|-------------------------------------------|---------------|------------|
| 111h | CHDECMISC | Channel Decode Miscellaneous | 00h | R/W/L, R/W |
| 200–201h | C0DRB0 | Channel 0 DRAM Rank Boundary Address 0 | 0000h | R/W/L, RO |
| 202–203h | C0DRB1 | Channel 0 DRAM Rank Boundary Address 1 | 0000h | RO, R/W/L |
| 204–205h | C0DRB2 | Channel 0 DRAM Rank Boundary Address 2 | 0000h | RO, R/W/L |
| 206–207h | C0DRB3 | Channel 0 DRAM Rank Boundary Address 3 | 0000h | R/W, RO |
| 208–209h | C0DRA01 | Channel 0 DRAM Rank 0,1 Attribute | 0000h | R/W/L |
| 20A–20Bh | C0DRA23 | Channel 0 DRAM Rank 2,3 Attribute | 0000h | R/W/L |
| 250–251h | C0CYTRKPCHG | Channel 0 CYTRK PCHG | 0000h | R/W, RO |
| 252–255h | C0CYTRKACT | Channel 0 CYTRK ACT | 00000000h | R/W, RO |
| 256–257h | C0CYTRKWR | Channel 0 CYTRK WR | 0000h | R/W |
| 258–25Ah | C0CYTRKRD | Channel 0 CYTRK READ | 000000h | R/W, RO |
| 25B–25Ch | C0CYTRKREFR | Channel 0 CYTRK REFR | 0000h | RO, R/W |
| 260–263h | C0CKECTRL | Channel 0 CKE Control | 00000800h | R/W, RO |
| 269–26Eh | C0REFRCTRL | Channel 0 DRAM Refresh Control | 24183000C30h | R/W, RO |
| 29C–29Fh | C0ODTCTRL | Channel 0 ODT Control | 00000000h | RO, R/W |
| 602–603h | C1DRB1 | Channel 1 DRAM Rank Boundary Address 1 | 0000h | R/W/L, RO |
| 604–605h | C1DRB2 | Channel 1 DRAM Rank Boundary Address 2 | 0000h | R/W/L, RO |
| 606–607h | C1DRB3 | Channel 1 DRAM Rank Boundary Address 3 | 0000h | R/W, RO |
| 608–609h | C1DRA01 | Channel 1 DRAM Rank 0,1 Attributes | 0000h | R/W/L |
| 60A–60Bh | C1DRA23 | Channel 1 DRAM Rank 2,3 Attributes | 0000h | R/W/L |
| 650–651h | C1CYTRKPCHG | Channel 1 CYTRK PCHG | 0000h | R/W, RO |
| 652–655h | C1CYTRKACT | Channel 1 CYTRK ACT | 00000000h | R/W, RO |
| 656–657h | C1CYTRKWR | Channel 1 CYTRK WR | 0000h | R/W |
| 658–65Ah | C1CYTRKRD | Channel 1 CYTRK READ | 000000h | R/W, RO |
| 660–663h | C1CKECTRL | Channel 1 CKE Control | 00000800h | R/W, RO |
| 669–66Eh | C1REFRCTRL | Channel 1 DRAM Refresh Control | 24183000C30h | R/W, RO |
| 69C–69Fh | C1ODTCTRL | Channel 1 ODT Control | 00000000h | R/W, RO |
| A00–A01h | EPC0DRB0 | EP Channel 0 DRAM Rank Boundary Address 0 | 0000h | R/W, RO |
| A02–A03h | EPC0DRB1 | EP Channel 0 DRAM Rank Boundary Address 1 | 0000h | RO, R/W |
| A04–A05h | EPC0DRB2 | EP Channel 0 DRAM Rank Boundary Address 2 | 0000h | RO, R/W |
| A06–A07h | EPC0DRB3 | EP Channel 0 DRAM Rank Boundary Address 3 | 0000h | R/W, RO |

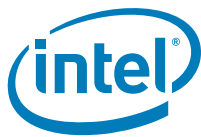

| Address Offset | Register Symbol | Register Name | Default Value | Access |
|----------------|------------------|-----------------------------------------|---------------|--------------------|
| A08–A09h | EPCODRA01 | EP Channel 0 DRAM Rank 0,1 Attribute | 0000h | R/W |
| A0A–A0Bh | EPCODRA23 | EP Channel 0 DRAM Rank 2,3 Attribute | 0000h | R/W |
| A19–A1Ah | EPDCYCTRKWRTPRE | EPD CYCTRK WRT PRE | 0000h | R/W, RO |
| A1C–A1Fh | EPDCYCTRKWR TACT | EPD CYCTRK WRT ACT | 00000000h | RO, R/W |
| A20–A21h | EPDCYCTRKWR TWR | EPD CYCTRK WRT WR | 0000h | R/W, RO |
| A22–A23h | EPDCYCTRKWR TREF | EPD CYCTRK WRT REF | 0000h | RO, R/W |
| A24–A26h | EPDCYCTRKWR TRD | EPD CYCTRK WRT READ | 000000h | R/W |
| A28–A2Ch | EPDCKECONFIG REG | EPD CKE related configuration registers | 00E0000000h | R/W |
| A30–A33h | EPDREFCONFIG | EP DRAM Refresh Configuration | 40000C30h | RO, R/W |
| CD8h | TSC1 | Thermal Sensor Control 1 | 00h | R/W/L, R/W, RS/WC |
| CD9h | TSC2 | Thermal Sensor Control 2 | 00h | R/W/L, RO |
| CDAh | TSS | Thermal Sensor Status | 00h | RO |
| CDC–CDFh | TSTTP | Thermal Sensor Temperature Trip Point | 00000000h | RO, R/W, R/W/L |
| CE2h | TCO | Thermal Calibration Offset | 00h | R/W/L/K, R/W/L |
| CE4h | THERM1 | Hardware Throttle Control | 00h | RO, R/W/L, R/W/L/K |
| CEA–CEBh | TIS | Thermal Interrupt Status | 0000h | R/WC, RO |
| CF1h | TSMICMD | Thermal SMI Command | 00h | RO, R/W |
| F14–F17h | PMSTS | Power Management Status | 00000000h | R/WC/S, RO |



5.2.1 CHDECMISC—Channel Decode Miscellaneous

B/D/F/Type: 0/0/0/MCHBAR
 Address Offset: 111h
 Default Value: 00h
 Access: R/W/L, R/W
 Size: 8 bits

This register provides miscellaneous CHDEC/MAGEN configuration bits.

| Bit | Access | Default Value | RST/PWR | Description |
|-----|--------|---------------|---------|-----------------------------------------------------------------------------------------------------------------------------------------------------------------------------------------------------------------------------------------------------------------------------------------------------------------------------------------------------------------------------------------------------------------------------------------------------------------------------------------------------------------------------------------------------------------------------------------------------------------|
| 7 | R/W/L | 0b | Core | <p>Enhanced Address for DIMM Select (ENHDIMMSEL): This bit can be set when enhanced mode of addressing for ranks are enabled and all four ranks are populated with equal amount of memory. This should be disabled when EP is present. 0 = Use Standard methods for DIMM Select. 1 = Use Enhanced Address as DIMM Select. This field is locked by ME stolen Memory lock.</p> |
| 6:5 | R/W/L | 00b | Core | <p>Enhanced Mode Select (ENHMODESEL): 00 = Swap Enabled for Bank Selects and Rank Selects 01 = XOR Enabled for Bank Selects and Rank Selects 10 = Swap Enabled for Bank Selects only 11 = XOR Enabled for Bank Select only This field is locked by ME stolen Memory lock.</p> |
| 4 | R/W/L | 0b | Core | <p>L-Shaped GFX Tile Cycle (LGFXTLCYC): This bit forces graphics tiled cycles in L-shaped memory configuration to modify bit 6 of the address. This field should be set to 1 only when L-mode memory configuration is enabled and should be set to 0 for all other memory configurations. This bit is locked by ME stolen Memory lock.</p> |
| 3 | R/W/L | 0b | Core | <p>Ch1 Enhanced Mode (CH1_ENHMODE): This bit indicates that enhanced addressing mode of operation is enabled for ch1. Enhanced addressing mode of operation should be enabled only when both the channels are equally populated with same size and same type of DRAM memory. An added restriction is that the number of ranks/channel has to be 1, 2, or 4. NOTE: If any of the channels is in enhanced mode, the other channel should also be in enhanced mode. This bit is locked by ME stolen Memory lock.</p> |



| Bit | Access | Default Value | RST/PWR | Description |
|-----|--------|---------------|---------|---------------------------------------------------------------------------------------------------------------------------------------------------------------------------------------------------------------------------------------------------------------------------------------------------------------------------------------------------------------------------------------------------------------------------------------------------------------------------------------------------------------------------------------------------|
| 2 | R/W/L | 0b | Core | <p>Ch0 Enhanced Mode (CHO_ENHMODE): This bit indicates that enhanced addressing mode of operation is enabled for ch0.</p> <p>Enhanced addressing mode of operation should be enabled only when both the channels are equally populated with same size and same type of DRAM memory. An added restriction is that the number of ranks/channel has to be 1, 2, or 4.</p> <p>NOTE: If any of the two channels is in enhanced mode, the other channel should also be in enhanced mode. This bit is locked by ME stolen Memory lock.</p> |
| 1 | R/W/L | 0b | Core | <p>Stacked Memory (STKMEM): This bit disables the L shaped memory configuration. When this bit is set, all the three channel memory appears as stacked, one above other.</p> <p>This bit is locked by ME stolen Memory lock.</p> |
| 0 | R/W | 0b | Core | <p>EP Present (EPPRSNT): This bit indicates whether EP UMA is present in the system or not.</p> <p>This bit is locked by ME stolen Memory lock.</p> |

5.2.2 CODRBO—Channel 0 DRAM Rank Boundary Address 0

B/D/F/Type: 0/0/0/MCHBAR
 Address Offset: 200-201h
 Default Value: 0000h
 Access: R/W/L, RO
 Size: 16 bits

The DRAM Rank Boundary Registers define the upper boundary address of each DRAM rank with a granularity of 64 MB. Each rank has its own single-word DRB register. These registers are used to determine which chip select will be active for a given address. Channel and rank map:

| | |
|------------|------|
| ch0 rank0: | 200h |
| ch0 rank1: | 202h |
| ch0 rank2: | 204h |
| ch0 rank3: | 206h |
| ch1 rank0: | 600h |
| ch1 rank1: | 602h |
| ch1 rank2: | 604h |
| ch1 rank3: | 606h |



Programming Guide

Non-stacked mode

If Channel 0 is empty, all of the C0DRBs are programmed with 00h.

C0DRB0 = Total memory in ch0 rank0 (in 64 MB increments)

C0DRB1 = Total memory in ch0 rank0 + ch0 rank1 (in 64 MB increments)

and so on.

If Channel 1 is empty, all of the C1DRBs are programmed with 00h.

C1DRB0 = Total memory in ch1 rank0 (in 64 MB increments)

C1DRB1 = Total memory in ch1 rank0 + ch1 rank1 (in 64 MB increments)

and so on.

Stacked mode:

C0DRBs:

Similar to Non-stacked mode.

C1DRB0, C1DRB1 and C1DRB2:

They are also programmed similar to non-stacked mode. Only exception is, the DRBs corresponding to the topmost populated rank and the (unpopulated) higher ranks in Channel 1 must be programmed with the value of the total Channel 1 population plus the value of total Channel 0 population (C0DRB3).

Example: If only ranks 0 and 1 are populated in Ch1 in stacked mode, then

C1DRB0 = Total memory in ch1 rank0 (in 64 MB increments)

C1DRB1 = C0DRB3 + Total memory in ch1 rank0 + ch1 rank1 (in 64 MB increments)
(rank 1 is the topmost populated rank)

C1DRB2 = C1DRB1

C1DRB3 = C1DRB1

C1DRB3:

C1DRB3 = C0DRB3 + Total memory in Channel 1.

| Bit | Access | Default Value | RST/PWR | Description |
|-------|--------|---------------|---------|-----------------------------------------------------------------------------------------------------------------------------------------------------------------------------------------------------------------------------------------------------------------------------------------------------------------------------------------------------------------------------------------------------|
| 15:10 | RO | 000000b | Core | Reserved |
| 9:0 | R/W/L | 000h | Core | <p>Channel 0 Dram Rank Boundary Address 0 (C0DRBA0): This register defines the DRAM rank boundary for rank0 of Channel 0 (64 MB granularity)</p> <p>=R0</p> <p>R0 = Total rank0 memory size/64 MB</p> <p>R1 = Total rank1 memory size/64 MB</p> <p>R2 = Total rank2 memory size/64 MB</p> <p>R3 = Total rank3 memory size/64 MB</p> <p>This register is locked by ME stolen Memory lock.</p> |



5.2.3 CODRB1—Channel 0 DRAM Rank Boundary Address 1

B/D/F/Type: 0/0/0/MCHBAR
 Address Offset: 202-203h
 Default Value: 0000h
 Access: RO, R/W/L
 Size: 16 bits

See the CODRB0 register for detailed descriptions.

| Bit | Access | Default Value | RST/PWR | Description |
|-------|--------|---------------|---------|---------------------------------------------------------------------------------------------------------------------------------------------------------------------------------------------------------------------------------------------------------------------------------------------------------------------------------------------------------------------------|
| 15:10 | RO | 000000b | Core | Reserved |
| 9:0 | R/W/L | 000h | Core | Channel 0 Dram Rank Boundary Address 1 (CODRBA1): This register defines the DRAM rank boundary for rank1 of Channel 0 (64 MB granularity) = (R1 + R0) R0 = Total rank0 memory size/64 MB R1 = Total rank1 memory size/64 MB R2 = Total rank2 memory size/64 MB R3 = Total rank3 memory size/64 MB This register is locked by ME stolen Memory lock. |

5.2.4 CODRB2—Channel 0 DRAM Rank Boundary Address 2

B/D/F/Type: 0/0/0/MCHBAR
 Address Offset: 204-205h
 Default Value: 0000h
 Access: RO, R/W/L
 Size: 16 bits

See the CODRB0 register for detailed descriptions.

| Bit | Access | Default Value | RST/PWR | Description |
|-------|--------|---------------|---------|--------------------------------------------------------------------------------------------------------------------------------------------------------------------------------------------------------------------------------------------------------------------------------------------------------------------------------------------------------------------------------|
| 15:10 | RO | 000000b | Core | Reserved |
| 9:0 | R/W/L | 000h | Core | Channel 0 DRAM Rank Boundary Address 2 (CODRBA2): This register defines the DRAM rank boundary for rank2 of Channel 0 (64 MB granularity) = (R2 + R1 + R0) R0 = Total rank0 memory size/64 MB R1 = Total rank1 memory size/64 MB R2 = Total rank2 memory size/64 MB R3 = Total rank3 memory size/64 MB This register is locked by ME stolen Memory lock. |



5.2.5 CODRB3—Channel 0 DRAM Rank Boundary Address 3

B/D/F/Type: 0/0/0/MCHBAR
 Address Offset: 206-207h
 Default Value: 0000h
 Access: R/W, RO
 Size: 16 bits

See the CODRB0 register for detailed descriptions.

| Bit | Access | Default Value | RST/PWR | Description |
|-------|--------|---------------|---------|--------------------------------------------------------------------------------------------------------------------------------------------------------------------------------------------------------------------------------------------------------------------------------------------------------------------------------------------------------------------------------------------------------------------------------------------------------------------|
| 15:10 | RO | 000000b | Core | Reserved |
| 9:0 | R/W | 000h | Core | <p>Channel 0 DRAM Rank Boundary Address 3 (CODRBA3): This register defines the DRAM rank boundary for rank3 of Channel 0 (64 MB granularity)</p> $= (R3 + R2 + R1 + R0)$ <p>R0 = Total rank0 memory size/64MB R1 = Total rank1 memory size/64MB R2 = Total rank2 memory size/64MB R3 = Total rank3 memory size/64MB</p> <p>This register is locked by ME stolen Memory lock.</p> |



5.2.6 CODRA01—Channel 0 DRAM Rank 0,1 Attribute

B/D/F/Type: 0/0/0/MCHBAR
 Address Offset: 208-209h
 Default Value: 0000h
 Access: R/W/L
 Size: 16 bits

The DRAM Rank Attribute Registers define the page sizes/number of banks to be used when accessing different ranks. These registers should be left with their default value (all zeros) for any rank that is unpopulated, as determined by the corresponding CxDRB registers. Each byte of information in the CxDRA registers describes the page size of a pair of ranks. Channel and rank map:

Ch0 Rank0, 1: 208h-209h
 Ch0 Rank2, 3: 20Ah-20Bh
 Ch1 Rank0, 1: 608h - 609h
 Ch1 Rank2, 3: 60Ah - 60Bh

DRA[6:0] = "00" means cfg0, DRA[6:0] = "01" means cfg1.... DRA[6:0] = "09" means cfg9 and so on.

DRA[7] indicates whether it's an 8 bank config or not. DRA[7] = 0 means 4 bank, DRA[7] = 1 means 8 bank.

Table 12. DRAM Rank Attribute Register Programming

| Cfg | Tech | DDRx | Depth | Width | Row | Col | Bank | Size | Size |
|-----|-------|------|-------|-------|-----|-----|------|--------|------|
| 0 | 256Mb | 2 | 32M | 8 | 13 | 10 | 2 | 256 MB | 8K |
| 1 | 256Mb | 2 | 16M | 16 | 13 | 9 | 2 | 128 MB | 4K |
| 2 | 512Mb | 2 | 64M | 8 | 14 | 10 | 2 | 512 MB | 8k |
| 3 | 512Mb | 2 | 32M | 16 | 13 | 10 | 2 | 256 MB | 8k |
| 4 | 512Mb | 3 | 64M | 8 | 13 | 10 | 3 | 512 MB | 8k |
| 5 | 512Mb | 3 | 32M | 16 | 12 | 10 | 3 | 256 MB | 8k |
| 6 | 1 Gb | 2,3 | 128M | 8 | 14 | 10 | 3 | 1 GB | 8k |
| 7 | 1 Gb | 2,3 | 64M | 16 | 13 | 10 | 3 | 512 MB | 8k |
| 8 | 2 Gb | 2,3 | 256M | 8 | 15 | 10 | 3 | 2 GB | 8k |
| 9 | 2 Gb | 2,3 | 128M | 16 | 14 | 10 | 3 | 1 GB | 8k |

| Bit | Access | Default Value | RST/PWR | Description |
|------|--------|---------------|---------|-------------------------------------------------------------------------------------------------------------------------------------------------------------------------------------------------------------------------|
| 15:8 | R/W/L | 00h | Core | Channel 0 DRAM Rank-1 Attributes (CODRA1): This register defines DRAM pagesize/number-of-banks for rank1 for given channel. See Table 12 . This register is locked by ME stolen Memory lock. |
| 7:0 | R/W/L | 00h | Core | Channel 0 DRAM Rank-0 Attributes (CODRA0): This register defines DRAM page size/number-of-banks for rank0 for given channel. See Table 12 . This register is locked by ME stolen Memory lock. |



5.2.7 CODRA23—Channel 0 DRAM Rank 2,3 Attribute

B/D/F/Type: 0/0/0/MCHBAR
 Address Offset: 20A-20Bh
 Default Value: 0000h
 Access: R/W/L
 Size: 16 bits

See the CODRA01 register for detailed descriptions.

| Bit | Access | Default Value | RST/PWR | Description |
|------|--------|---------------|---------|------------------------------------------------------------------------------------------------------------------------------------------------------------------------------------------------------------------------|
| 15:8 | R/W/L | 00h | Core | Channel 0 DRAM Rank-3 Attributes (CODRA3): This register defines DRAM pagesize/number-of-banks for rank3 for given channel. See Table 12 . This register is locked by ME stolen Memory lock. |
| 7:0 | R/W/L | 00h | Core | Channel 0 DRAM Rank-2 Attributes (CODRA2): This register defines DRAM pagesize/number-of-banks for rank2 for given channel. See Table 12 . This register is locked by ME stolen Memory lock. |

5.2.8 COCYCTRKPCHG—Channel 0 CYCTRK PCHG

B/D/F/Type: 0/0/0/MCHBAR
 Address Offset: 250-251h
 Default Value: 0000h
 Access: R/W, RO
 Size: 16 bits

This register is for Channel 0 CYCTRK Precharge control.

| Bit | Access | Default Value | RST/PWR | Description |
|-------|--------|---------------|---------|-----------------------------------------------------------------------------------------------------------------------------------------------------------------------------------------------------------------------------------------------------|
| 15:11 | RO | 00000b | Core | Reserved |
| 10:6 | R/W | 00000b | Core | Write To PRE Delayed (C0sd_cr_wr_pchg): This configuration register indicates the minimum allowed spacing (in DRAM clocks) between the WRITE and PRE commands to the same rank-bank. This field corresponds to tWR in the DDR Specification. |
| 5:2 | R/W | 0000b | Core | READ To PRE Delayed (C0sd_cr_rd_pchg): This field indicates the minimum allowed spacing (in DRAM clocks) between the READ and PRE commands to the same rank-bank |
| 1:0 | R/W | 00b | Core | PRE To PRE Delayed (C0sd_cr_pchg_pchg): This field indicates the minimum allowed spacing (in DRAM clocks) between two PRE commands to the same rank. |



5.2.9 COCYCTRKACT—Channel 0 CYCTRK ACT

B/D/F/Type: 0/0/0/MCHBAR
 Address Offset: 252-255h
 Default Value: 00000000h
 Access: R/W, RO
 Size: 32 bits

This register is for Channel 0 CYCTRK Activate.

| Bit | Access | Default Value | RST/PWR | Description |
|-------|--------|---------------|---------|----------------------------------------------------------------------------------------------------------------------------------------------------------------------------------------------------------------------------------------------------------------------------------------------------------------------------------------------------------------------------------------------------------------------------------------------------|
| 31:30 | RO | 0h | Core | Reserved |
| 29 | R/W | 0b | Core | FAW Windowcnt Bug Fix Disable (C0sd_cr_cyctrk_faw_windowcnt_fix_disable): This configuration register disables the CYCTRK FAW windowcnt bug fix. 1 = Disable CYCTRK FAW windowcnt bug fix 0 = Enable CYCTRK FAW windowcnt bug fix |
| 28 | R/W | 0b | Core | FAW Phase Bug Fix Disable (C0sd_cr_cyctrk_faw_phase_fix_disable): This configuration register disables the CYCTRK FAW phase indicator bug fix. 1 = Disable CYCTRK FAW phase indicator bug fix 0 = Enable CYCTRK FAW phase indicator bug fix |
| 27:22 | R/W | 000000b | Core | ACT Window Count (C0sd_cr_act_windowcnt): This configuration register indicates the window duration (in DRAM clocks) during which the controller counts the # of activate commands which are launched to a particular rank. If the number of activate commands launched within this window is greater than 4, then a check is implemented to block launch of further activates to this rank for the rest of the duration of this window. |
| 21 | R/W | 0b | Core | Max ACT Check (C0sd_cr_maxact_dischk): This configuration register enables the check which ensures that there are no more than four activates to a particular rank in a given window. |
| 20:17 | R/W | 0000b | Core | ACT to ACT Delayed (C0sd_cr_act_act[]): This configuration register indicates the minimum allowed spacing (in DRAM clocks) between two ACT commands to the same rank. This field corresponds to tRRD in the DDR Specification. |
| 16:13 | R/W | 0000b | Core | PRE to ACT Delayed (C0sd_cr_pre_act): This configuration register indicates the minimum allowed spacing (in DRAM clocks) between the PRE and ACT commands to the same rank-bank: 12:9R/W0000bPRE-ALL to ACT Delayed (C0sd_cr_preall_act): This configuration register indicates the minimum allowed spacing (in DRAM clocks) between the PRE-ALL and ACT commands to the same rank. This field corresponds to tRP in the DDR Specification. |



| Bit | Access | Default Value | RST/PWR | Description |
|------|--------|---------------|---------|-------------------------------------------------------------------------------------------------------------------------------------------------------------------------------------------------------------------------------------------|
| 12:9 | R/W | 0h | Core | ALLPRE to ACT Delay (C0sd0_cr_preall_act) : From the launch of a prechargeall command wait for these many # of memory clocks before launching a activate command. This field corresponds to tPALL_RP. in the DDR Specification. |
| 8:0 | R/W | 000000000b | Core | REF to ACT Delayed (C0sd_cr_rfsh_act) : This configuration register indicates the minimum allowed spacing (in DRAM clocks) between REF and ACT commands to the same rank. This field corresponds to tRFC in the DDR Specification. |

5.2.10 COCYCTRKWR—Channel 0 CYCTRK WR

B/D/F/Type: 0/0/0/MCHBAR
 Address Offset: 256-257h
 Default Value: 0000h
 Access: R/W
 Size: 16 bits

| Bit | Access | Default Value | RST/PWR | Description |
|-------|--------|---------------|---------|-------------------------------------------------------------------------------------------------------------------------------------------------------------------------------------------------------------------------------------------------------------|
| 15:12 | R/W | 0h | Core | ACT To Write Delay (C0sd_cr_act_wr) : This configuration register indicates the minimum allowed spacing (in DRAM clocks) between the ACT and WRITE commands to the same rank-bank. This field corresponds to tRCD_wr in the DDR Specification. |
| 11:8 | R/W | 0h | Core | Same Rank Write To Write Delayed (C0sd_cr_wrsr_wr) : This configuration register indicates the minimum allowed spacing (in DRAM clocks) between two WRITE commands to the same rank. |
| 7:4 | R/W | 0h | Core | Different Rank Write to Write Delay (C0sd_cr_wrdr_wr) : This configuration register indicates the minimum allowed spacing (in DRAM clocks) between two WRITE commands to different ranks. This field corresponds to tWR_WR in the DDR Specification. |
| 3:0 | R/W | 0h | Core | READ To WRTE Delay (C0sd_cr_rd_wr) : This configuration register indicates the minimum allowed spacing (in DRAM clocks) between the READ and WRITE commands. This field corresponds to tRD_WR in the DDR Specification. |



5.2.11 COCYCTRKRD—Channel 0 CYCTRK READ

B/D/F/Type: 0/0/0/MCHBAR
 Address Offset: 258-25Ah
 Default Value: 000000h
 Access: R/W, RO
 Size: 24 bits

| Bit | Access | Default Value | RST/PWR | Description |
|-------|--------|---------------|---------|------------------------------------------------------------------------------------------------------------------------------------------------------------------------------------------------------------------------------------------------------------------------|
| 23:21 | RO | 000b | Core | Reserved |
| 20:17 | R/W | 0h | Core | Min ACT To READ Delayed (C0sd_cr_act_rd): This configuration register indicates the minimum allowed spacing (in DRAM clocks) between the ACT and READ commands to the same rank-bank. This field corresponds to tRCD_rd in the DDR Specification. |
| 16:12 | R/W | 00000b | Core | Same Rank Write To READ Delayed (C0sd_cr_wrsr_rd): This configuration register indicates the minimum allowed spacing (in DRAM clocks) between the WRITE and READ commands to the same rank. This field corresponds to tWTR in the DDR Specification. |
| 11:8 | R/W | 0000b | Core | Different Ranks Write To READ Delayed (C0sd_cr_wrd_r_rd): This configuration register indicates the minimum allowed spacing (in DRAM clocks) between the WRITE and READ commands to different ranks. This field corresponds to tWR_RD in the DDR Specification. |
| 7:4 | R/W | 0000b | Core | Same Rank Read To Read Delayed (C0sd_cr_rdsr_rd): This configuration register indicates the minimum allowed spacing (in DRAM clocks) between two READ commands to the same rank. |
| 3:0 | R/W | 0000b | Core | Different Ranks Read To Read Delayed (C0sd_cr_rddr_rd): This configuration register indicates the minimum allowed spacing (in DRAM clocks) between two READ commands to different ranks. This field corresponds to tRD_RD in the DDR Specification. |



5.2.12 COCYCTRKREFR—Channel 0 CYCTRK REFR

B/D/F/Type: 0/0/0/MCHBAR
 Address Offset: 25B-25Ch
 Default Value: 0000h
 Access: RO, R/W
 Size: 16 bits

This register is for Channel 0 CYCTRK Refresh.

| Bit | Access | Default Value | RST/PWR | Description |
|-------|--------|---------------|---------|--------------------------------------------------------------------------------------------------------------------------------------------------------------------------------------------------------|
| 15:13 | RO | 000b | Core | Reserved |
| 12:9 | R/W | 0000b | Core | Same Rank PALL to REF Delayed (COsd_cr_pchgall_rfsh): This configuration register indicates the minimum allowed spacing (in DRAM clocks) between the PRE-ALL and REF commands to the same rank. |
| 8:0 | R/W | 000000000b | Core | Same Rank REF to REF Delayed (COsd_cr_rfsh_rfsh): This configuration register indicates the minimum allowed spacing (in DRAM clocks) between two REF commands to same ranks. |

5.2.13 COCKECTRL—Channel 0 CKE Control

B/D/F/Type: 0/0/0/MCHBAR
 Address Offset: 260-263h
 Default Value: 00000800h
 Access: R/W, RO
 Size: 32 bits

| Bit | Access | Default Value | RST/PWR | Description |
|-------|--------|---------------|---------|----------------------------------------------------------------------------------------------------------------------------------------------------------------------------------------------------------------------------|
| 31:28 | RO | 0000b | Core | Reserved |
| 27 | R/W | 0b | Core | start the self-refresh exit sequence (sd0_cr_srcstart): This configuration register indicates the request to start the self-refresh exit sequence |
| 26:24 | R/W | 000b | Core | CKE pulse width requirement in high phase (sd0_cr_cke_pw_hl_safe): This configuration register indicates CKE pulse width requirement in high phase. This field corresponds to tCKE (high) in the DDR Specification. |
| 23 | R/W | 0b | Core | Rank 3 Population (sd0_cr_rankpop3): 1 = Rank 3 populated 0 = Rank 3 not populated This register is locked by ME stolen Memory lock. |
| 22 | R/W | 0b | Core | Rank 2 Population (sd0_cr_rankpop2): 1 = Rank 2 populated 0 = Rank 2 not populated This register is locked by ME stolen Memory lock. |



| Bit | Access | Default Value | RST/PWR | Description |
|-------|--------|----------------|---------|----------------------------------------------------------------------------------------------------------------------------------------------------------------------------------------------------------------------------------------------------------------------------------------|
| 21 | R/W | 0b | Core | Rank 1 Population (sd0_cr_rankpop1): 1 = Rank 1 populated 0 = Rank 1 not populated This register is locked by ME stolen Memory lock. |
| 20 | R/W | 0b | Core | Rank 0 Population (sd0_cr_rankpop0): 1 = Rank 0 populated 0 = Rank 0 not populated This register is locked by ME stolen Memory lock. |
| 19:17 | R/W | 000b | Core | CKE pulse width requirement in low phase (sd0_cr_cke_pw_lh_safe): This configuration register indicates CKE pulse width requirement in low phase. This field corresponds to tCKE (low) in the DDR Specification. |
| 16 | R/W | 0b | Core | Enable CKE toggle for PDN entry/exit (sd0_cr_pdn_enable): This configuration bit indicates that the toggling of CKEs (for PDN entry/exit) is enabled. |
| 15:14 | RO | 00b | Core | Reserved |
| 13:10 | R/W | 0010b | Core | Minimum Powerdown exit to Non-Read command spacing (sd0_cr_txp): This configuration register indicates the minimum number of clocks to wait following assertion of CKE before issuing a non-read command. 1010–1111=Reserved. 0010–1001=2–9clocks. 0000–0001=Reserved. |
| 9:1 | R/W | 000000000 b | Core | Self refresh exit count (sd0_cr_slfrfsh_exit_cnt): This configuration register indicates the Self refresh exit count. (Program to 255). This field corresponds to tXSNR/ tXSRD in the DDR Specification. |
| 0 | R/W | 0b | Core | Indicates Only 1 DIMM Populated (sd0_cr_singledimmpop): This configuration register indicates the that only 1 DIMM is populated. |



5.2.14 COREFRCTRL—Channel 0 DRAM Refresh Control

B/D/F/Type: 0/0/0/MCHBAR
 Address Offset: 269-26Eh
 Default Value: 241830000C30h
 Access: R/W, RO
 Size: 48 bits

This register provides settings to configure the DRAM refresh controller.

| Bit | Access | Default Value | RST/PWR | Description |
|-------|--------|---------------|---------|-------------------------------------------------------------------------------------------------------------------------------------------------------------------------------------------------------------------------------------------------------------------------------------------------------------------------------------------------------------------------------------------------------------------------------------------------------------------------------------------------------------------------------------------------------------------------------------------------------------------------------|
| 47 | RO | 0b | Core | Reserved |
| 46:44 | R/W | 010b | Core | Initial Refresh Count (sd0_cr_init_refrcnt): This field specifies the initial refresh count value. |
| 43:38 | R/W | 010000b | Core | Direct Rcomp Quiet Window (DIRQUIET): This configuration setting indicates the amount of refresh_tick events to wait before the service of rcomp request in non-default mode of independent rank refresh. |
| 37:32 | R/W | 011000b | Core | Indirect Rcomp Quiet Window (INDIRQUIET): This configuration setting indicates the amount of refresh_tick events to wait before the service of rcomp request in non-default mode of independent rank refresh. |
| 31:27 | R/W | 00110b | Core | Rcomp Wait (RCOMPWAIT): This configuration setting indicates the amount of refresh_tick events to wait before the service of rcomp request in non-default mode of independent rank refresh. |
| 26 | R/W | 0b | Core | ZOCAL Enable (ZOCALEN): This bit enables the DRAM controller to issue ZOCAL S command periodically. |
| 25 | R/W | 0b | Core | Refresh Counter Enable (REFCNTEN): This bit is used to enable the refresh counter to count during times that DRAM is not in self-refresh, but refreshes are not enabled. Such a condition may occur due to need to reprogram DIMMs following DRAM controller switch. This bit has no effect when Refresh is enabled (i.e., there is no mode where Refresh is enabled but the counter does not run). So, along with bit 23 REFEN, the modes are: REFEN:REFCNTEN Description 0:0 Normal refresh disable 0:1 Refresh disabled, but counter is accumulating refreshes. 1:X Normal refresh enable |
| 24 | R/W | 0b | Core | All Rank Refresh (ALLRKREF): This bit enables (by default) that all the ranks are refreshed in a staggered/atomic fashion. If set, the ranks are refreshed in an independent fashion. |
| 23 | R/W | 0b | Core | Refresh Enable (REFEN): 0 = Disabled 1 = Enabled |
| 22 | R/W | 0b | Core | DDR Initialization Done (INITDONE): This bit indicates that DDR initialization is complete. |



| Bit | Access | Default Value | RST/PWR | Description |
|-------|--------|---------------------|---------|-----------------------------------------------------------------------------------------------------------------------------------------------------------------------------------------------------------------------------------------------------------------------------------------------------------------------------------------------------------------------------------------------------------------------------------------|
| 21:20 | R/W | 00b | Core | <p>DRAM Refresh Hysterisis (REFHYSTERISIS): Hysterisis level - Useful for dref_high watermark cases. The dref_high flag is set when the dref_high watermark level is exceeded, and is cleared when the refresh count is less than the hysterisis level. This bit should be set to a value less than the high watermark level.</p> <p>00 = 3 01 = 4 10 = 5 11 = 6</p> |
| 19:18 | R/W | 00b | Core | <p>DRAM Refresh Panic Watermark (REFPANICWM): When the refresh count exceeds this level, a refresh request is launched to the scheduler and the dref_panic flag is set.</p> <p>00 = 5 01 = 6 10 = 7 11 = 8</p> |
| 17:16 | R/W | 00b | Core | <p>DRAM Refresh High Watermark (REFHIGHWM): When the refresh count exceeds this level, a refresh request is launched to the scheduler and the dref_high flag is set.</p> <p>00 = 3 01 = 4 10 = 5 11 = 6</p> |
| 15:14 | R/W | 00b | Core | <p>DRAM Refresh Low Watermark (REFLOWWM): When the refresh count exceeds this level, a refresh request is launched to the scheduler and the dref_low flag is set.</p> <p>00 = 1 01 = 2 10 = 3 11 = 4</p> |
| 13:0 | R/W | 001100001 10000b | Core | <p>Refresh Counter Time Out Value (REFTIMEOUT): Program this field with a value that will provide 7.8 us at the memory clock frequency. At various memory clock frequencies, this results in the following values:</p> <p>266 MHz -> 820 hex 333 MHz -> A28 hex 400 MHz -> C30 hex 533 MHz -> 104B hex 666 MHz -> 1450 hex</p> |



5.2.15 COODTCTRL—Channel 0 ODT Control

B/D/F/Type: 0/0/0/MCHBAR
 Address Offset: 29C-29Fh
 Default Value: 00000000h
 Access: RO, R/W
 Size: 32 bits

| Bit | Access | Default Value | RST/PWR | Description |
|-------|--------|---------------|---------|------------------------------------------------------------------------------------------------------------------------------------------------------------------------------------------------------------------------------------------------------------|
| 31:12 | RO | 00000h | Core | Reserved |
| 11:8 | R/W | 0000b | Core | DRAM ODT for Read Commands (sd0_cr_odt_duration_rd): This field specifies the duration in memory clocks to assert DRAM ODT for Read Commands. The Async value should be used when the Dynamic Powerdown bit is set; otherwise, use the Sync value. |
| 7:4 | R/W | 0000b | Core | DRAM ODT for Write Commands (sd0_cr_odt_duration_wr): This field specifies the duration in memory clocks to assert DRAM ODT for Write Commands. The Async value should be used when the Dynamic Powerdown bit is set; otherwise use the Sync value. |
| 3:0 | R/W | 0000b | Core | MCH ODT for Read Commands (sd0_cr_mchodt_duration): This field specifies the duration in memory clocks to assert (G)MCH ODT for Read Commands. |

5.2.16 C1DRB1—Channel 1 DRAM Rank Boundary Address 1

B/D/F/Type: 0/0/0/MCHBAR
 Address Offset: 602-603h
 Default Value: 0000h
 Access: R/W/L, RO
 Size: 16 bits

The operation of this register is detailed in the description for the C0DRB0 register.

| Bit | Access | Default Value | RST/PWR | Description |
|-------|--------|---------------|---------|-------------------------------------------------------------------------------------------------------------------------------------------------------------------------------------------------------------------------------------------------|
| 15:10 | RO | 000000b | Core | Reserved |
| 9:0 | R/W/L | 000h | Core | Channel 1 DRAM Rank Boundary Address 1 (C1DRBA1): See C0DRB1. In stacked mode, if this is the topmost populated rank in Channel 1, program this value to be cumulative of Ch0 DRB3. This register is locked by ME stolen Memory lock. |



5.2.17 C1DRB2—Channel 1 DRAM Rank Boundary Address 2

B/D/F/Type: 0/0/0/MCHBAR
Address Offset: 604-605h
Default Value: 0000h
Access: R/W/L, RO
Size: 16 bits

The operation of this register is detailed in the description for the C0DRB0 register.

| Bit | Access | Default Value | RST/PWR | Description |
|-------|--------|---------------|---------|-------------------------------------------------------------------------------------------------------------------------------------------------------------------------------------------------------------------------------------------------|
| 15:10 | RO | 000000b | Core | Reserved |
| 9:0 | R/W/L | 000h | Core | Channel 1 DRAM Rank Boundary Address 2 (C1DRBA2): See C0DRB2. In stacked mode, if this is the topmost populated rank in Channel 1, program this value to be cumulative of Ch0 DRB3. This register is locked by ME stolen Memory lock. |

5.2.18 C1DRB3—Channel 1 DRAM Rank Boundary Address 3

B/D/F/Type: 0/0/0/MCHBAR
Address Offset: 606-607h
Default Value: 0000h
Access: R/W, RO
Size: 16 bits

The operation of this register is detailed in the description for the C0DRB0 register.

| Bit | Access | Default Value | RST/PWR | Description |
|-------|--------|---------------|---------|---------------------------------------------------------------------------------------------------------------------------------------------------------------------------------|
| 15:10 | RO | 000000b | Core | Reserved |
| 9:0 | R/W | 000h | Core | Channel 1 DRAM Rank Boundary Address 3 (C1DRBA3): See C0DRB3. In stacked mode, this will be cumulative of Ch0 DRB3. This register is locked by ME stolen Memory lock. |



5.2.19 C1DRA01—Channel 1 DRAM Rank 0,1 Attributes

B/D/F/Type: 0/0/0/MCHBAR
 Address Offset: 608-609h
 Default Value: 0000h
 Access: R/W/L
 Size: 16 bits

The operation of this register is detailed in the description for the C0DRA01 register.

| Bit | Access | Default Value | RST/PWR | Description |
|------|--------|---------------|---------|--------------------------------------------------------------------------------------------------------------------|
| 15:8 | R/W/L | 00h | Core | Channel 1 DRAM Rank-1 Attributes (C1DRA1): See C0DRA1. This register is locked by ME stolen Memory lock. |
| 7:0 | R/W/L | 00h | Core | Channel 1 DRAM Rank-0 Attributes (C1DRA0): See C0DRA0. This register is locked by ME stolen Memory lock. |

5.2.20 C1DRA23—Channel 1 DRAM Rank 2,3 Attributes

B/D/F/Type: 0/0/0/MCHBAR
 Address Offset: 60A-60Bh
 Default Value: 0000h
 Access: R/W/L
 Size: 16 bits

The operation of this register is detailed in the description for the C0DRA01 register.

| Bit | Access | Default Value | RST/PWR | Description |
|------|--------|---------------|---------|--------------------------------------------------------------------------------------------------------------------|
| 15:8 | R/W/L | 00h | Core | Channel 1 DRAM Rank-3 Attributes (C1DRA3): See C0DRA3. This register is locked by ME stolen Memory lock. |
| 7:0 | R/W/L | 00h | Core | Channel 1 DRAM Rank-2 Attributes (C1DRA2): See C0DRA2. This register is locked by ME stolen Memory lock. |



5.2.21 C1CYCTRPCHG—Channel 1 CYCTRK PCHG

B/D/F/Type: 0/0/0/MCHBAR
Address Offset: 650-651h
Default Value: 0000h
Access: R/W, RO
Size: 16 bits

| Bit | Access | Default Value | RST/PWR | Description |
|-------|--------|---------------|---------|-------------------------------------------------------------------------------------------------------------------------------------------------------------------------------------------------------------------------------------|
| 15:11 | RO | 00000b | Core | Reserved. |
| 10:6 | R/W | 00000b | Core | Write To PRE Delayed (C1sd_cr_wr_pchg) : This field indicates the minimum allowed spacing (in DRAM clocks) between the WRITE and PRE commands to the same rank-bank. This field corresponds to tWR in the DDR Specification. |
| 5:2 | R/W | 0000b | Core | READ To PRE Delayed (C1sd_cr_rd_pchg) : This field indicates the minimum allowed spacing (in DRAM clocks) between the READ and PRE commands to the same rank-bank |
| 1:0 | R/W | 00b | Core | PRE To PRE Delayed (C1sd_cr_pchg_pchg) : This field indicates the minimum allowed spacing (in DRAM clocks) between two PRE commands to the same rank. |



5.2.22 C1CYCTRKACT—Channel 1 CYCTRK ACT

B/D/F/Type: 0/0/0/MCHBAR
 Address Offset: 652-655h
 Default Value: 00000000h
 Access: R/W, RO
 Size: 32 bits

| Bit | Access | Default Value | RST/PWR | Description |
|-------|--------|---------------|---------|------------------------------------------------------------------------------------------------------------------------------------------------------------------------------------------------------------------------------------------------------------------------------------------------------------------------------------------------------------------------------------------------------------------------------------|
| 31:30 | RO | 0h | Core | Reserved |
| 29 | R/W | 0b | Core | FAW Windowcnt Bug Fix Disable (C1sd_cr_cyctrk_faw_windowcnt_fix_disable): This field disables the CYCTRK FAW windowcnt bug fix. 1 = Disable CYCTRK FAW windowcnt bug fix 0 = Enable CYCTRK FAW windowcnt bug fix |
| 28 | R/W | 0b | Core | FAW Phase Bug Fix Disable (C1sd_cr_cyctrk_faw_phase_fix_disable): This field disables the CYCTRK FAW phase indicator bug fix. 1 = Disable CYCTRK FAW phase indicator bug fix 0 = Enable CYCTRK FAW phase indicator bug fix |
| 27:22 | R/W | 000000b | Core | ACT Window Count (C1sd_cr_act_windowcnt): This field indicates the window duration (in DRAM clocks) during which the controller counts the # of activate commands which are launched to a particular rank. If the number of activate commands launched within this window is greater than 4, then a check is implemented to block launch of further activates to this rank for the rest of the duration of this window. |
| 21 | R/W | 0b | Core | Max ACT Check (C1sd_cr_maxact_dischk): This field enables the check which ensures that there are no more than four activates to a particular rank in a given window. |
| 20:17 | R/W | 0000b | Core | ACT to ACT Delayed (C1sd_cr_act_act[]): This field indicates the minimum allowed spacing (in DRAM clocks) between two ACT commands to the same rank. This field corresponds to tRRD in the DDR Specification. |
| 16:13 | R/W | 0000b | Core | PRE to ACT Delayed (C1sd_cr_pre_act): This field indicates the minimum allowed spacing (in DRAM clocks) between the PRE and ACT commands to the same rank-bank: 12:9R/W0000bPRE-ALL to ACT Delayed (C1sd_cr_preall_act):. This configuration register indicates the minimum allowed spacing (in DRAM clocks) between the PRE-ALL and ACT commands to the same rank. This field corresponds to tRP in the DDR Specification. |
| 12:9 | R/W | 0h | Core | ALLPRE to ACT Delay (C1sd_cr_preall_act): From the launch of a prechargeall command wait for this number of memory clocks before launching a activate command. This field corresponds to tPALL_RP in the DDR specification. |
| 8:0 | R/W | 000000000b | Core | REF to ACT Delayed (C1sd_cr_rfsh_act): This field indicates the minimum allowed spacing (in DRAM clocks) between REF and ACT commands to the same rank. This field corresponds to tRFC in the DDR Specification. |



5.2.23 C1CYCTRKWR—Channel 1 CYCTRK WR

B/D/F/Type: 0/0/0/MCHBAR
Address Offset: 656-657h
Default Value: 0000h
Access: R/W
Size: 16 bits

| Bit | Access | Default Value | RST/PWR | Description |
|-------|--------|---------------|---------|-------------------------------------------------------------------------------------------------------------------------------------------------------------------------------------------------------------------------------------------|
| 15:12 | R/W | 0h | Core | ACT To Write Delay (C1sd_cr_act_wr): This field indicates the minimum allowed spacing (in DRAM clocks) between the ACT and WRITE commands to the same rank-bank. This field corresponds to tRCD_wr in the DDR Specification. |
| 11:8 | R/W | 0h | Core | Same Rank Write To Write Delayed (C1sd_cr_wrsr_wr): This field indicates the minimum allowed spacing (in DRAM clocks) between two WRITE commands to the same rank. |
| 7:4 | R/W | 0h | Core | Different Rank Write to Write Delay (C1sd_cr_wrdr_wr): This field indicates the minimum allowed spacing (in DRAM clocks) between two WRITE commands to different ranks. This field corresponds to tWR_WR in the DDR Specification. |
| 3:0 | R/W | 0h | Core | READ To WRTE Delay (C1sd_cr_rd_wr): This field indicates the minimum allowed spacing (in DRAM clocks) between the READ and WRITE commands. This field corresponds to tRD_WR in the DDR specification. |



5.2.24 C1CYCTRKR—Channel 1 CYCTRK READ

B/D/F/Type: 0/0/0/MCHBAR
 Address Offset: 658-65Ah
 Default Value: 000000h
 Access: R/W, RO
 Size: 24 bits

| Bit | Access | Default Value | RST/PWR | Description |
|-------|--------|---------------|---------|-------------------------------------------------------------------------------------------------------------------------------------------------------------------------------------------------------------------------------------------------------|
| 23:21 | RO | 0h | Core | Reserved |
| 20:17 | R/W | 0h | Core | Min ACT To READ Delayed (C1sd_cr_act_rd) : This field indicates the minimum allowed spacing (in DRAM clocks) between the ACT and READ commands to the same rank-bank. This field corresponds to tRCD_rd in the DDR Specification. |
| 16:12 | R/W | 00000b | Core | Same Rank Write To READ Delayed (C1sd_cr_wrsr_rd) : This field indicates the minimum allowed spacing (in DRAM clocks) between the WRITE and READ commands to the same rank. This field corresponds to tWTR in the DDR Specification. |
| 11:8 | R/W | 0000b | Core | Different Ranks Write To READ Delayed (C1sd_cr_wrdr_rd) : This field indicates the minimum allowed spacing (in DRAM clocks) between the WRITE and READ commands to different ranks. This field corresponds to tWR_RD in the DDR Specification. |
| 7:4 | R/W | 0000b | Core | Same Rank Read To Read Delayed (C1sd_cr_rdsr_rd) : This field indicates the minimum allowed spacing (in DRAM clocks) between two READ commands to the same rank. |
| 3:0 | R/W | 0000b | Core | Different Ranks Read To Read Delayed (C1sd_cr_rddr_rd) : This field indicates the minimum allowed spacing (in DRAM clocks) between two READ commands to different ranks. This field corresponds to tRD_RD in the DDR Specification. |

5.2.25 C1CKCTRL—Channel 1 CKE Control

B/D/F/Type: 0/0/0/MCHBAR
 Address Offset: 660-663h
 Default Value: 00000800h
 Access: R/W, RO
 Size: 32 bits

| Bit | Access | Default Value | RST/PWR | Description |
|-------|--------|---------------|---------|------------------------------------------------------------------------------------------------------------------------------------------------------------------------------------------------------------|
| 31:28 | RO | 0h | Core | Reserved |
| 27 | R/W | 0b | Core | start the self-refresh exit sequence (sd1_cr_srcstart) : This field indicates the request to start the self-refresh exit sequence |
| 26:24 | R/W | 000b | Core | CKE pulse width requirement in high phase (sd1_cr_cke_pw_hl_safe) : This field indicates CKE pulse width requirement in high phase. This field corresponds to tCKE (high) in the DDR Specification. |



| Bit | Access | Default Value | RST/PWR | Description |
|-------|--------|---------------|---------|----------------------------------------------------------------------------------------------------------------------------------------------------------------------------------------------------------------------------------------------------------------------------------------------|
| 23 | R/W | 0b | Core | Rank 3 Population (sd1_cr_rankpop3): 1 = Rank 3 populated 0 = Rank 3 not populated This register is locked by ME stolen Memory lock. |
| 22 | R/W | 0b | Core | Rank 2 Population (sd1_cr_rankpop2): 1 = Rank 2 populated 0 = Rank 2 not populated This register is locked by ME stolen Memory lock. |
| 21 | R/W | 0b | Core | Rank 1 Population (sd1_cr_rankpop1): 1 = Rank 1 populated 0 = Rank 1 not populated This register is locked by ME stolen Memory lock. |
| 20 | R/W | 0b | Core | Rank 0 Population (sd1_cr_rankpop0): 1 = Rank 0 populated 0 = Rank 0 not populated This register is locked by ME stolen Memory lock. |
| 19:17 | R/W | 000b | Core | CKE pulse width requirement in low phase (sd1_cr_cke_pw_lh_safe): This field indicates CKE pulse width requirement in low phase. This field corresponds to tCKE (low) in the DDR Specification. |
| 16 | R/W | 0b | Core | Enable CKE toggle for PDN entry/exit (sd1_cr_pdn_enable): This bit indicates that the toggling of CKEs (for PDN entry/exit) is enabled. |
| 15:14 | RO | 00b | Core | Reserved |
| 13:10 | R/W | 0010b | Core | Minimum Powerdown Exit to Non-Read command spacing (sd1_cr_txp): This configuration register indicates the minimum number of clocks to wait following assertion of CKE before issuing a non-read command. 1010–1111 = Reserved. 0010–1001 = 2–9 clocks 0000–0001 = Reserved. |
| 9:1 | R/W | 000000000b | Core | Self refresh exit count (sd1_cr_slfrsh_exit_cnt): This field indicates the Self refresh exit count. (Program to 255). This field corresponds to tXSNR/tXSRD in the DDR Specification. |
| 0 | R/W | 0b | Core | Indicates Only 1 DIMM Populated (sd1_cr_singledimmpop): This field indicates the that only 1 DIMM is populated. |



5.2.26 C1REFRCTRL—Channel 1 DRAM Refresh Control

B/D/F/Type: 0/0/0/MCHBAR
 Address Offset: 669-66Eh
 Default Value: 24183000C30h
 Access: R/W, RO
 Size: 48 bits

This register provides settings to configure the DRAM refresh controller.

| Bit | Access | Default Value | RST/PWR | Description |
|-------|--------|---------------|---------|----------------------------------------------------------------------------------------------------------------------------------------------------------------------------------------------------------------------------------------------------------------------------------------------------------------------------------------------------------------------------------------------------------------------------------------------------------------------------------------------------------------------------------------------------------------------------------------------------------------------------------|
| 47 | RO | 0b | Core | Reserved |
| 46:44 | R/W | 010b | Core | Initial Refresh Count (sd1_cr_init_refrcnt): This field specifies the initial refresh count value. |
| 43:38 | R/W | 010000b | Core | Direct Rcomp Quiet Window (DIRQUIET): This configuration setting indicates the amount of refresh_tick events to wait before the service of rcomp request in non-default mode of independent rank refresh. |
| 37:32 | R/W | 011000b | Core | Indirect Rcomp Quiet Window (INDIRQUIET): This configuration setting indicates the amount of refresh_tick events to wait before the service of rcomp request in non-default mode of independent rank refresh. |
| 31:27 | R/W | 00110b | Core | Rcomp Wait (RCOMPWAIT): This configuration setting indicates the amount of refresh_tick events to wait before the service of rcomp request in non-default mode of independent rank refresh. |
| 26 | R/W | 0b | Core | ZQCAL Enable (ZQCALEN): This bit enables the DRAM controller to issue ZQCAL S command periodically. |
| 25 | R/W | 0b | Core | Refresh Counter Enable (REFCNTEN): This bit is used to enable the refresh counter to count during times that DRAM is not in self-refresh, but refreshes are not enabled. Such a condition may occur due to need to reprogram DIMMs following DRAM controller switch. This bit has no effect when Refresh is enabled (i.e. there is no mode where Refresh is enabled but the counter does not run) So, in conjunction with bit 23 REFEN, the modes are: REFEN:REFCNTEN Description 0:0 Normal refresh disable 0:1 Refresh disabled, but counter is accumulating refreshes. 1:X Normal refresh enable |
| 24 | R/W | 0b | Core | All Rank Refresh (ALLRKREF): This configuration bit enables (by default) that all the ranks are refreshed in a staggered/atomic fashion. If set, the ranks are refreshed in an independent fashion. |
| 23 | R/W | 0b | Core | Refresh Enable (REFEN): 0 = Disabled 1 = Enabled |
| 22 | R/W | 0b | Core | DDR Initialization Done (INITDONE): This bit indicates that DDR initialization is complete. |



| Bit | Access | Default Value | RST/PWR | Description |
|-------|--------|---------------------|---------|-----------------------------------------------------------------------------------------------------------------------------------------------------------------------------------------------------------------------------------------------------------------------------------------------------------------------------------------------------------------------------------------------------------------------------------------|
| 21:20 | R/W | 00b | Core | <p>DRAM Refresh Hysterisis (REFHYSTERISIS): Hysterisis level - Useful for dref_high watermark cases. The dref_high flag is set when the dref_high watermark level is exceeded, and is cleared when the refresh count is less than the hysterisis level. This bit should be set to a value less than the high watermark level.</p> <p>00 = 3 01 = 4 10 = 5 11 = 6</p> |
| 19:18 | R/W | 00b | Core | <p>DRAM Refresh Panic Watermark (REFPANICWM): When the refresh count exceeds this level, a refresh request is launched to the scheduler and the dref_panic flag is set.</p> <p>00 = 5 01 = 6 10 = 7 11 = 8</p> |
| 17:16 | R/W | 00b | Core | <p>DRAM Refresh High Watermark (REFHIGHWM): When the refresh count exceeds this level, a refresh request is launched to the scheduler and the dref_high flag is set.</p> <p>00 = 3 01 = 4 10 = 5 11 = 6</p> |
| 15:14 | R/W | 00b | Core | <p>DRAM Refresh Low Watermark (REFLOWWM): When the refresh count exceeds this level, a refresh request is launched to the scheduler and the dref_low flag is set.</p> <p>00 = 1 01 = 2 10 = 3 11 = 4</p> |
| 13:0 | R/W | 001100001 10000b | Core | <p>Refresh Counter Time Out Value (REFTIMEOUT): Program this field with a value that will provide 7.8 us at the memory clock frequency. At various memory frequencies this results in the following values:</p> <p>266 MHz -> 820 hex 333 MHz -> A28 hex 400 MHz -> C30 hex 533 MHz -> 104B hex 666 MHz -> 1450 hex</p> |



5.2.27 C1ODTCTRL—Channel 1 ODT Control

B/D/F/Type: 0/0/0/MCHBAR
 Address Offset: 69C-69Fh
 Default Value: 00000000h
 Access: R/W, RO
 Size: 32 bits

| Bit | Access | Default Value | RST/PWR | Description |
|-------|--------|---------------|---------|-------------------------------------------------------------------------------------------------------------------------------------------------------------------------------------------------------------------------------------------------------------|
| 31:12 | RO | 00000h | Core | Reserved |
| 11:8 | R/W | 0h | Core | DRAM ODT for Read Commands (sd1_cr_odt_duration_rd): This field specifies the duration in memory clocks to assert DRAM ODT for Read Commands. The Async value should be used when the Dynamic Powerdown bit is set; otherwise use the Sync value. |
| 7:4 | R/W | 0h | Core | DRAM ODT for Write Commands (sd1_cr_odt_duration_wr): This field specifies the duration in memory clocks to assert DRAM ODT for Write Commands. The Async value should be used when the Dynamic Powerdown bit is set; otherwise, use the Sync value. |
| 3:0 | R/W | 0h | Core | MCH ODT for Read Commands (sd1_cr_mchodt_duration): This field specifies the duration in memory clocks to assert (G)MCH ODT for Read Commands. |

5.2.28 EPCODRBO—EP Channel 0 DRAM Rank Boundary Address 0

B/D/F/Type: 0/0/0/MCHBAR
 Address Offset: A00-A01h
 Default Value: 0000h
 Access: R/W, RO
 Size: 16 bits

| Bit | Access | Default Value | RST/PWR | Description |
|-------|--------|---------------|---------|----------------------------------------------------------|
| 15:10 | RO | 000000b | Core | Reserved |
| 9:0 | R/W | 000h | Core | Channel 0 Dram Rank Boundary Address 0 (CODRBA0): |



5.2.29 EPCODRB1—EP Channel 0 DRAM Rank Boundary Address 1

B/D/F/Type: 0/0/0/MCHBAR
Address Offset: A02-A03h
Default Value: 0000h
Access: RO, R/W
Size: 16 bits

See C0DRB0 register for description.

| Bit | Access | Default Value | RST/PWR | Description |
|-------|--------|---------------|---------|----------------------------------------------------------|
| 15:10 | RO | 000000b | Core | Reserved |
| 9:0 | R/W | 000h | Core | Channel 0 Dram Rank Boundary Address 1 (C0DRBA1): |

5.2.30 EPCODRB2—EP Channel 0 DRAM Rank Boundary Address 2

B/D/F/Type: 0/0/0/MCHBAR
Address Offset: A04-A05h
Default Value: 0000h
Access: RO, R/W
Size: 16 bits

See C0DRB0 register for description.

| Bit | Access | Default Value | RST/PWR | Description |
|-------|--------|---------------|---------|----------------------------------------------------------|
| 15:10 | RO | 000000b | Core | Reserved |
| 9:0 | R/W | 000h | Core | Channel 0 DRAM Rank Boundary Address 2 (C0DRBA2): |

5.2.31 EPCODRB3—EP Channel 0 DRAM Rank Boundary Address 3

B/D/F/Type: 0/0/0/MCHBAR
Address Offset: A06-A07h
Default Value: 0000h
Access: R/W, RO
Size: 16 bits

See C0DRB0 register for description.

| Bit | Access | Default Value | RST/PWR | Description |
|-------|--------|---------------|---------|----------------------------------------------------------|
| 15:10 | RO | 000000b | Core | Reserved |
| 9:0 | R/W | 000h | Core | Channel 0 DRAM Rank Boundary Address 3 (C0DRBA3): |



5.2.32 EPCODRA01—EP Channel 0 DRAM Rank 0,1 Attribute

B/D/F/Type: 0/0/0/MCHBAR
 Address Offset: A08-A09h
 Default Value: 0000h
 Access: R/W
 Size: 16 bits

The DRAM Rank Attribute Registers define the page sizes/number of banks to be used when accessing different ranks. These registers should be left with their default value (all zeros) for any rank that is unpopulated, as determined by the corresponding CxDRB registers. Each byte of information in the CxDRA registers describes the page size of a pair of ranks. Channel and rank map:

Ch0 Rank0, 1: 108h–109h
 Ch0 Rank2, 3: 10Ah–10Bh
 Ch1 Rank0, 1: 188h–189h
 Ch1 Rank2, 3: 18Ah–18Bh

| Bit | Access | Default Value | RST/PWR | Description |
|------|--------|---------------|---------|---------------------------------------------------------------------------------------------------------------------------------|
| 15:8 | R/W | 00h | Core | Channel 0 DRAM Rank-1 Attributes (CODRA1): This field defines DRAM pagesize/number-of-banks for rank1 for given channel. |
| 7:0 | R/W | 00h | Core | Channel 0 DRAM Rank-0 Attributes (CODRA0): This field defines DRAM pagesize/number-of-banks for rank0 for given channel. |

5.2.33 EPCODRA23—EP Channel 0 DRAM Rank 2,3 Attribute

B/D/F/Type: 0/0/0/MCHBAR
 Address Offset: A0A-A0Bh
 Default Value: 0000h
 Access: R/W
 Size: 16 bits

See CODRA01 for detailed descriptions.

| Bit | Access | Default Value | RST/PWR | Description |
|------|--------|---------------|---------|---------------------------------------------------------------------------------------------------------------------------------|
| 15:8 | R/W | 00h | Core | Channel 0 DRAM Rank-3 Attributes (CODRA3): This field defines DRAM pagesize/number-of-banks for rank3 for given channel. |
| 7:0 | R/W | 00h | Core | Channel 0 DRAM Rank-2 Attributes (CODRA2): This field defines DRAM pagesize/number-of-banks for rank2 for given channel. |



5.2.34 EPDCYCTRKWRTPRE—EPD CYCTRK WRT PRE

B/D/F/Type: 0/0/0/MCHBAR
 Address Offset: A19-A1Ah
 Default Value: 0000h
 Access: R/W, RO
 Size: 16 bits

| Bit | Access | Default Value | RST/PWR | Description |
|-------|--------|---------------|---------|-----------------------------------------------------------------------------------------------------------------------------------------------------------------------------|
| 15:11 | R/W | 00000b | Core | ACT To PRE Delayed (C0sd_cr_act_pchg) : This field indicates the minimum allowed spacing (in DRAM clocks) between the ACT and PRE commands to the same rank-bank. |
| 10:6 | R/W | 00000b | Core | Write To PRE Delayed (C0sd_cr_wr_pchg) : This field indicates the minimum allowed spacing (in DRAM clocks) between the WRITE and PRE commands to the same rank-bank. |
| 5:2 | R/W | 0000b | Core | READ To PRE Delayed (C0sd_cr_rd_pchg) : This field indicates the minimum allowed spacing (in DRAM clocks) between the READ and PRE commands to the same rank-bank. |
| 1:0 | RO | 00b | Core | Reserved |

5.2.35 EPDCYCTRKWRTACT—EPD CYCTRK WRT ACT

B/D/F/Type: 0/0/0/MCHBAR
 Address Offset: A1C-A1Fh
 Default Value: 00000000h
 Access: RO, R/W
 Size: 32 bits

| Bit | Access | Default Value | RST/PWR | Description |
|-------|--------|---------------|---------|-----------------------------------------------------------------------------------------------------------------------------------------------------------------------------------------------------------------------------------------------------------------------------------------------------------------------------------------------------------------------------|
| 31:21 | RO | 000h | Core | Reserved |
| 20:17 | R/W | 0000b | Core | ACT to ACT Delayed (C0sd_cr_act_act[]) : This field indicates the minimum allowed spacing (in DRAM clocks) between two ACT commands to the same rank. |
| 16:13 | R/W | 0000b | Core | PRE to ACT Delayed (C0sd_cr_pre_act) : This field indicates the minimum allowed spacing (in DRAM clocks) between the PRE and ACT commands to the same rank-bank: 12:9R/W0000bPRE-ALL to ACT Delayed (C0sd_cr_preall_act):. This configuration register indicates the minimum allowed spacing (in DRAM clocks) between the PRE-ALL and ACT commands to the same rank. |
| 12:9 | RO | 0h | Core | Reserved |
| 8:0 | R/W | 000000000b | Core | REF to ACT Delayed (C0sd_cr_rfsh_act) : This field indicates the minimum allowed spacing (in DRAM clocks) between REF and ACT commands to the same rank. |



5.2.36 EPDCYCTRKWRTWR—EPD CYCTRK WRT WR

B/D/F/Type: 0/0/0/MCHBAR
 Address Offset: A20-A21h
 Default Value: 0000h
 Access: R/W, RO
 Size: 16 bits

| Bit | Access | Default Value | RST/PWR | Description |
|-------|--------|---------------|---------|--------------------------------------------------------------------------------------------------------------------------------------------------------------------------------|
| 15:12 | R/W | 0h | Core | ACT To Write Delay (C0sd_cr_act_wr) : This field indicates the minimum allowed spacing (in DRAM clocks) between the ACT and WRITE commands to the same rank-bank. |
| 11:8 | R/W | 0h | Core | Same Rank Write To Write Delayed (C0sd_cr_wrsr_wr) : This field indicates the minimum allowed spacing (in DRAM clocks) between two WRITE commands to the same rank. |
| 7:4 | RO | 0h | Core | Reserved |
| 3:0 | R/W | 0h | Core | Same Rank WRITE to READ Delay (C0sd_cr_rd_wr) : This field indicates the minimum allowed spacing (in DRAM clocks) between the WRITE and READ commands to the same rank. |

5.2.37 EPDCYCTRKWRTREF—EPD CYCTRK WRT REF

B/D/F/Type: 0/0/0/MCHBAR
 Address Offset: A22-A23h
 Default Value: 0000h
 Access: RO, R/W
 Size: 16 bits
 BIOS Optimal Default 0h

EPD CYCTRK WRT ACT Status Register.

| Bit | Access | Default Value | RST/PWR | Description |
|-------|--------|---------------|---------|-------------------------------------------------------------------------------------------------------------------------------------------------------------------------------|
| 15:13 | RO | 000b | Core | Reserved |
| 12:9 | RO | 0h | | Reserved |
| 8:0 | R/W | 000000000b | Core | Different Rank REF to REF Delayed (C0sd_cr_rfsh_rfsh) : This field indicates the minimum allowed spacing (in DRAM clocks) between two REF commands to different ranks. |



5.2.38 EPDCYCTRKWRTRD—EPD CYCTRK WRT READ

B/D/F/Type: 0/0/0/MCHBAR
Address Offset: A24-A26h
Default Value: 000000h
Access: R/W
Size: 24 bits
BIOS Optimal Default 000h

| Bit | Access | Default Value | RST/PWR | Description |
|-------|--------|---------------|---------|-----------------------------------------------------------------------------------------------------------------------------------------------------------------------------|
| 23:23 | RO | 0h | | Reserved |
| 22:20 | R/W | 000b | Core | EPDunit DQS Slave DLL Enable to Read Safe (EPDSDLL2RD) : This field provides setting for Read command safe from the point of enabling the slave DLLs. |
| 19:18 | RO | 0h | | Reserved |
| 17:14 | R/W | 0h | Core | Min ACT To READ Delayed (C0sd_cr_act_rd) : This field indicates the minimum allowed spacing (in DRAM clocks) between the ACT and READ commands to the same rank-bank |
| 13:9 | R/W | 00000b | Core | Same Rank READ to WRITE Delayed (C0sd_cr_wrsr_rd) : This field indicates the minimum allowed spacing (in DRAM clocks) between the READ and WRITE commands. |
| 8:6 | RO | 0h | | Reserved |
| 5:3 | R/W | 000b | Core | Same Rank Read To Read Delayed (C0sd_cr_rdsr_rd) : This field indicates the minimum allowed spacing (in DRAM clocks) between two READ commands to the same rank. |
| 2:0 | RO | 0h | | Reserved |



5.2.39 EPDCKECONFIGREG—EPD CKE Related Configuration Registers

B/D/F/Type: 0/0/0/MCHBAR
 Address Offset: A28-A2Ch
 Default Value: 00E0000000h
 Access: R/W
 Size: 40 bits
 BIOS Optimal Default 0h

| Bit | Access | Default Value | RST/PWR | Description |
|-------|--------|---------------|---------|-----------------------------------------------------------------------------------------------------------------------------------------------------------------------------------------------------------------------------------------|
| 39:35 | R/W | 00000b | Core | EPDunit TXPDLL Count (EPDTPDLL): This field specifies the delay from precharge power down exit to a command that requires the DRAM DLL to be operational. The commands are read/write. |
| 34:32 | R/W | 000b | Core | EPDunit TXP count (EPDCKETXP): This field specifies the timing requirement for Active power down exit or fast exit pre-charge power down exit to any command or slow exit pre-charge power down to Non-DLL (rd/wr/odt). command. |
| 31:29 | R/W | 111b | Core | Mode Select (sd0_cr_sms): Mode Select register: This field setting indicates the mode in which the controller is operating in. 111 = Indicates normal mode of operation, else special mode of operation. |
| 28:27 | R/W | 00b | Core | EPDunit EMRS command select. (EPDEMRSEL): EMRS mode to select BANK address. 01 = EMRS 10 = EMRS2 11 = EMRS3 |
| 26:24 | R/W | 000b | Core | CKE pulse width requirement in high phase (sd0_cr_cke_pw_hl_safe): This field indicates CKE pulse width requirement in high phase. |
| 23:20 | R/W | 0h | Core | one-hot active rank population (ep_scr_actrank): This field indicates the active rank in a one hot manner. |
| 19:17 | R/W | 000b | Core | CKE pulse width requirement in low phase (sd0_cr_cke_pw_lh_safe): This field indicates CKE pulse width requirement in low phase. |
| 16:15 | RO | 0h | | Reserved |
| 14 | R/W | 0b | Core | EPDunit MPR mode (EPDMPR): 1 = MPR mode 0 = Normal mode In MPR mode, only read cycles must be issued by Firmware. Page Results are ignored by DCS and just issues the read chip select. |
| 13 | R/W | 0b | Core | EPDunit Power Down enable for ODT Rank (EPDOAPDEN): This bit enables the ODT ranks to dynamically enter power down. 1 = Enable active power down. 0 = Disable active power down. |



| Bit | Access | Default Value | RST/PWR | Description |
|-------|--------|----------------|---------|-------------------------------------------------------------------------------------------------------------------------------------------------------------------------------------------------------------------------------------------------------------------|
| 12 | R/W | 0b | Core | EPDunit Power Down enable for Active Rank (EPDAAPDEN): This bit enables the active rank to dynamically enter power down. 1 = Enable active power down. 0 = Disable active power down. |
| 11:10 | RO | 0h | | Reserved |
| 9:1 | R/W | 0000000 00b | Core | Self refresh exit count (sd0_cr_slfrsh_exit_cnt): This field indicates the Self refresh exit count. Program to 255. |
| 0 | R/W | 0b | Core | indicates only 1 rank enabled (sd0_cr_singledimmpop): This field indicates that only 1 rank is enabled. This bit needs to be set if there is one active rank and no odt ranks, or if there is one active rank and one odt rank and they are the same rank. |

5.2.40 EPDREFCONFIG—EP DRAM Refresh Configuration

B/D/F/Type: 0/0/0/MCHBAR
 Address Offset: A30-A33h
 Default Value: 40000C30h
 Access: RO, R/W
 Size: 32 bits

| Bit | Access | Default Value | RST/PWR | Description |
|-------|--------|---------------|---------|----------------------------------------------------------------------------------------------------------------------------------------------------------------------------------------------------------------------------------------------------------------------------------------------------------------------------------------------------------------------------------------------------------------------------------------------------------------------------------------------------------------------------------------------------------------------------------------------------------------------------------|
| 31 | RO | 0b | Core | Reserved |
| 30:29 | R/W | 10b | Core | EPDunit refresh count addition for self refresh exit. (EPDREF4SR): This field indicates the number of additional refreshes that needs to be added to the refresh request count after exiting self refresh. Typical value is to add 2 refreshes. 00 = Add 0 Refreshes 01 = Add 1 Refreshes 10 = Add 2 Refreshes 11 = Add 3 Refreshes |
| 28 | R/W | 0b | Core | Refresh Counter Enable (REFCNTEN): This bit is used to enable the refresh counter to count during times that DRAM is not in self-refresh, but refreshes are not enabled. Such a condition may occur due to need to reprogram DIMMs following DRAM controller switch. This bit has no effect when Refresh is enabled (i.e. there is no mode where Refresh is enabled but the counter does not run) So, in conjunction with bit 23 REFEN, the modes are: REFEN:REFCNTEN Description 0:0 Normal refresh disable 0:1 Refresh disabled, but counter is accumulating refreshes. 1:X Normal refresh enable |

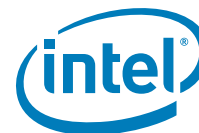

| Bit | Access | Default Value | RST/PWR | Description |
|-------|--------|---------------------|---------|-----------------------------------------------------------------------------------------------------------------------------------------------------------------------------------------------------------------------------------------------------------------------------------------------------------------------------------------------------------------------------------|
| 27 | R/W | 0b | Core | Refresh Enable (REFEN): 0 = Disabled 1 = Enabled |
| 26 | R/W | 0b | Core | DDR Initialization Done (INITDONE): This bit indicates that DDR initialization is complete. |
| 25:22 | R/W | 0000b | Core | DRAM Refresh Hysterisis (REFHYSTERISIS): Hysterisis level - Useful for dref_high watermark cases. The dref_high flag is set when the dref_high watermark level is exceeded, and is cleared when the refresh count is less than the hysterisis level. This bit should be set to a value less than the high watermark level. 0000 = 0 0001 = 1 1000 = 8 |
| 21:18 | R/W | 0000b | Core | DRAM Refresh High Watermark (REFHIGHWM): When the refresh count exceeds this level, a refresh request is launched to the scheduler and the dref_high flag is set. 0000 = 0 0001 = 1 1000 = 8 |
| 17:14 | R/W | 0000b | Core | DRAM Refresh Low Watermark (REFLOWWM): When the refresh count exceeds this level, a refresh request is launched to the scheduler and the dref_low flag is set. 0000 = 0 0001 = 1 1000 = 8 |
| 13:0 | R/W | 001100001 10000b | Core | Refresh Counter Time Out Value (REFTIMEOUT): Program this field with a value that will provide 7.8 us at the memory clock frequency. At various memory clock frequencies this results in the following values: 266 MHz -> 820 hex 333 MHz -> A28 hex 400 MHz -> C30 hex 533 MHz -> 104B hex 666 MHz -> 1450 hex |



5.2.41 TSC1—Thermal Sensor Control 1

B/D/F/Type: 0/0/0/MCHBAR
 Address Offset: CD8h
 Default Value: 00h
 Access: R/W/L, R/W, RS/WC
 Size: 8 bits

This register controls the operation of the thermal sensor.

Bits 7:1 of this register are reset to their defaults by MPWROK.

Bit 0 is reset to its default by PLTRST#.

| Bit | Access | Default Value | RST/PWR | Description |
|-----|--------|---------------|---------|--------------------------------------------------------------------------------------------------------------------------------------------------------------------------------------------------------------------------------------------------------------------------------------------------------------------------------------------------------------------------------------------------------------------------------------------------------------|
| 7 | R/W/L | 0b | Core | Thermal Sensor Enable (TSE): This bit enables power to the thermal sensor. Lockable via TCO bit 7. 0 = Disabled 1 = Enabled |
| 6 | R/W | 0b | Core | Analog Hysteresis Control (AHC): This bit enables the analog hysteresis control to the thermal sensor. When enabled, about 1 degree of hysteresis is applied. This bit should normally be off in thermometer mode since the thermometer mode of the thermal sensor defeats the usefulness of analog hysteresis. 0 = hysteresis disabled 1 = analog hysteresis enabled. |
| 5:2 | R/W | 0000b | Core | Digital Hysteresis Amount (DHA): This bit determines whether no offset, 1 LSB, 2... 15 is used for hysteresis for the trip points. 0000 = digital hysteresis disabled, no offset added to trip temperature 0001 = offset is 1 LSB added to each trip temperature when tripped ... 0110 = ~3.0 °C (Recommended setting) ... 1110 = added to each trip temperature when tripped 1111 = added to each trip temperature when tripped |
| 1 | R/W/L | 0b | Core | Thermal Sensor Comparator Select (TSCS): This bit multiplexes between the two analog comparator outputs. Normally Catastrophic is used. Lockable via TCO bit 7. 0 = Catastrophic 1 = Hot |



| Bit | Access | Default Value | RST/PWR | Description |
|-----|--------|---------------|---------|-------------------------------------------------------------------------------------------------------------------------------------------------------------------------------------------------------------------------------------------------------------------------------------------------------------------------------------------------------------------------------------------------------------------------------------------------------------------------------------------------------------------------------------------------------------------------------------------------------------------------------------------------------------------------------------------------------------------------------------------------------------------------------------------------------------------------------------------------------------------------------|
| 0 | RS/WC | 0b | Core | <p>In Use (IU): Software semaphore bit.</p> <p>After a full (G)MCH RESET, a read to this bit returns a 0. After the first read, subsequent reads will return a 1. A write of a 1 to this bit will reset the next read value to 0. Writing a 0 to this bit has no effect.</p> <p>Software can poll this bit until it reads a 0, and will then own the usage of the thermal sensor.</p> <p>This bit has no other effect on the hardware, and is only used as a semaphore among various independent software threads that may need to use the thermal sensor.</p> <p>Software that reads this register but does not intend to claim exclusive access of the thermal sensor must write a one to this bit if it reads a 0, in order to allow other software threads to claim it.</p> <p>See also THERM3 bit 7 and IUB, which are independent additional semaphore bits.</p> |

5.2.42 TSC2—Thermal Sensor Control 2

B/D/F/Type: 0/0/0/MCHBAR
 Address Offset: CD9h
 Default Value: 00h
 Access: R/W/L, RO
 Size: 8 bits

This register controls the operation of the thermal sensor.
 All bits in this register are reset to their defaults by MPWROK.



| Bit | Access | Default Value | RST/PWR | Description |
|-----|--------|---------------|---------|------------------------------------------------------------------------------------------------------------------------------------------------------------------------------------------------------------------------------------------------------------------------------------------------------------------------------------------------------------------------------------------------------------------------------------------------------------------------------------------------------------------------------------------------------------------------------------------------------------------------------------------------------------------------------------------------------------------------------------------------------------------------------------------------------------------------------------------------------------------------------------------------------------------------------------------------------------------------------------------------------------------------------------------------------------------------------------------------------------------------------------------------------------------------------------------------------------------------------------------------------------------------------------------------------------------------------------------------------------------------------------------------------------------------------------------------------------------------------------------------------------------------------------------------------------------------------------------------------------------------------------------------------------------------------------------------------------------------------------------------------------------------------------------------------------------------------------------------------------------------------------------------------------------------------------------------------------------------------------------------------------------------------------------------------------------------------------------------------------------------------------------------------------------------------------------------------------------------------------------------------------------------------------------------------------------------------------|
| 7:4 | RO | 0h | Core | Reserved |
| 3:0 | R/W/L | 0h | Core | <p>Thermometer Mode Enable and Rate (TE): If analog thermal sensor mode is not enabled by setting these bits to 0000b, these bits enable the thermometer mode functions and set the Thermometer controller rate.</p> <p>When the Thermometer mode is disabled and TSC1[TSE] = enabled, the analog sensor mode should be fully functional. In the analog sensor mode, the Catastrophic trip is functional, and the Hot trip is functional at the offset below the catastrophic programmed into TSC2[CHO]. The other trip points are not functional in this mode.</p> <p>When Thermometer mode is enabled, all the trip points (Catastrophic, Hot, Aux0) will all operate using the programmed trip points and Thermometer mode rate.</p> <p>NOTE:</p> <ol style="list-style-type: none"> When disabling the Thermometer mode while thermometer running, the Thermometer mode controller will finish the current cycle. During boot, all other thermometer mode registers (except lock bits) should be programmed appropriately before enabling the Thermometer Mode. <p>Clocks are memory clocks.</p> <p>NOTE: Since prior (G)MCHs counted the thermometer rate in terms of host clocks rather than memory clocks, the clock count for each setting listed below has been doubled from what is was on those (G)MCHs. This should make the actual thermometer rate approximately equivalent across products.</p> <p>Lockable via TCO bit 7.</p> <p>0000 = Thermometer mode disabled (i.e, analog sensor mode)</p> <p>0001 = enabled, 512 clock mode</p> <p>0010 = enabled, 1024 clock mode (normal Thermometer mode operation), provides ~3.85 us settling time @ 266 MHz provides ~3.08 us settling time @ 333 MHz provides ~2.56 us settling time @ 400 MHz</p> <p>0011 = enabled, 1536 clock mode</p> <p>0100 = enabled, 2048 clock mode</p> <p>0101 = enabled, 3072 clock mode</p> <p>0110 = enabled, 4096 clock mode</p> <p>0111 = enabled, 6144 clock mode provides ~23.1 us settling time @ 266 MHz provides ~18.5 us settling time @ 333 MHz provides ~15.4 us settling time @ 400 MHz</p> <p>all other permutations reserved</p> <p>1111 = enabled, 4 clock mode (for testing digital logic)</p> |



5.2.43 TSS—Thermal Sensor Status

B/D/F/Type: 0/0/0/MCHBAR
 Address Offset: CDAh
 Default Value: 00h
 Access: RO
 Size: 8 bits

This read only register provides trip point and other status of the thermal sensor.

All bits in this register are reset to their defaults by MPWROK.

| Bit | Access | Default Value | RST/PWR | Description |
|-----|--------|---------------|---------|-----------------------------------------------------------------------------------------------------------------------------------------------------------------------------------------------------------------------------------------------------------------------------------------------------------------------------------------------------------------------------------|
| 7 | RO | 0b | Core | Catastrophic Trip Indicator (CTI): 1 = Internal thermal sensor temperature is above the catastrophic setting. |
| 6 | RO | 0b | Core | Hot Trip Indicator (HTI): 1 = Internal thermal sensor temperature is above the Hot setting. |
| 5 | RO | 0b | Core | Aux0 Trip Indicator (A0TI): 1 = A 1 indicates that the internal thermal sensor temperature is above the Aux0 setting. |
| 4 | RO | 0b | Core | Thermometer Mode Output Valid (TOV): 1 = Thermometer mode is able to converge to a temperature and that the TR register is reporting a reasonable estimate of the thermal sensor temperature. 0 = Thermometer mode is off, or that temperature is out of range, or that the TR register is being looked at before a temperature conversion has had time to complete. |
| 3:2 | RO | 00b | Core | Reserved |
| 1 | RO | 0b | Core | Direct Catastrophic Comparator Read (DCCR): This bit reads the output of the Catastrophic comparator directly, without latching via the Thermometer mode circuit. Used for testing. |
| 0 | RO | 0b | Core | Direct Hot Comparator Read (DHCR): This bit reads the output of the Hot comparator directly, without latching via the Thermometer mode circuit. Used for testing. |



5.2.44 TSTTP—Thermal Sensor Temperature Trip Point

B/D/F/Type: 0/0/0/MCHBAR
 Address Offset: CDC-CDFh
 Default Value: 00000000h
 Access: RO, R/W, R/W/L
 Size: 32 bits

This register:

1. Sets the target values for the trip points in thermometer mode. See also TST [Direct DAC Connect Test Enable].
2. Reports the relative thermal sensor temperature

All bits in this register are reset to their defaults by MPWROK.

| Bit | Access | Default Value | RST/PWR | Description |
|-------|--------|---------------|---------|-----------------------------------------------------------------------------------------------------------------------------------------------------------------------------------------------------------------------------------------------------------------------------------------------------------------------------------------------------------------------------------------------------------------------------------------------------------------------------------------------------------------------------|
| 31:24 | RO | 00h | Core | Relative Temperature (RELT): In Thermometer mode, the RELT field of this register report the relative temperature of the thermal sensor. Provides a two's complement value of the thermal sensor relative to the Hot Trip Point. Temperature above the Hot Trip Point will be positive. TR and HTPS can both vary between 0 and 255. But RELT will be clipped between ± 127 to keep it an 8 bit number. See also TSS[Thermometer mode Output Valid] In the Analog mode, the RELT field reports HTPS value. |
| 23:16 | R/W | 00h | Core | Aux0 Trip point setting (AOTPS): This field sets the target for the Aux0 trip point. |
| 15:8 | R/W/L | 00h | Core | Hot Trip Point Setting (HTPS): This field sets the target value for the Hot trip point. Lockable via TCO bit 7. |
| 7:0 | R/W/L | 00h | Core | Catastrophic Trip Point Setting (CTPS): This field sets the target for the Catastrophic trip point. See also TST[Direct DAC Connect Test Enable]. Lockable via TCO bit 7. |



5.2.45 TCO—Thermal Calibration Offset

B/D/F/Type: 0/0/0/MCHBAR
 Address Offset: CE2h
 Default Value: 00h
 Access: R/W/L/K, R/W/L
 Size: 8 bits

Bit 7 reset to its default by PLTRST#

Bits 6:0 reset to their defaults by MPWROK

| Bit | Access | Default Value | RST/PWR | Description |
|-----|---------|---------------|---------|---------------------------------------------------------------------------------------------------------------------------------------------------------------------------------------------------------------------------------------------------------------------------------------------------------------------------------------------------------------------------------------------------------------------------------------------------------------------------------------------------------------------------------------------------------------------------------------------------------------------------------------------------------------------------------------------------------------------------------------------------------------------------------------------------------------------------------------------------------------------------------------------------------|
| 7 | R/W/L/K | 0b | Core | Lock Bit for Catastrophic (LBC): This bit, when written to a 1, locks the Catastrophic programming interface, including bits 7:0 of this register and bits 15:0 of TSTTP, bits 1,7 of TSC 1, bits 3:0 of TSC 2, bits 4:0 of TSC 3, and bits 0,7 of TST. This bit may only be set to a 0 by a hardware reset (PLTRST#). Writing a 0 to this bit has no effect. |
| 6:0 | R/W/L | 00h | Core | Calibration Offset (CO): This field contains the current calibration offset for the Thermal Sensor DAC inputs. The calibration offset is a twos complement signed number which is added to the temperature counter value to help generate the final value going to the thermal sensor DAC. This field is Read/Write and can be modified by Software unless locked by setting bit 7 of this register. The fuses cannot be programmed via this register. Once this register has been overwritten by software, the values of the TCO fuses can be read using the Therm3 register. Note for TCO operation: While this is a seven-bit field, the 7th bit is sign extended to 9 bits for TCO operation. The range of 00h to 3fh corresponds to 0 0000 0000 to 0 0011 1111. The range of 41h to 7Fh corresponds to 1 1100 001 (i.e, negative 3Fh) to 1 1111 1111 (i.e, negative 1), respectively. |



5.2.46 THERM1—Hardware Throttle Control

B/D/F/Type: 0/0/0/MCHBAR
 Address Offset: CE4h
 Default Value: 00h
 Access: RO, R/W/L, R/W/L/K
 Size: 8 bits

All bits in this register are reset to their defaults by PLTRST#.

| Bit | Access | Default Value | RST/PWR | Description |
|-----|---------|---------------|---------|-----------------------------------------------------------------------------------------------------------------------------------------------------------------------------------------------------------------------------------------------------------------------------------------------------------------------------------------------------------------------------------------------------------------------------------------------------------------------------------------------------------------------|
| 7 | R/W/L | 0b | Core | Internal Thermal Hardware Throttling Enable (ITHTE): This bit is a master enable for internal thermal sensor-based hardware throttling. 0 = Hardware actions via the internal thermal sensor are disabled. 1 = Hardware actions via the internal thermal sensor are enabled. |
| 6 | R/W/L | 0b | Core | Internal Thermal Hardware Throttling Type (ITHTT): This policy bit determines what type of hardware throttling will be enacted by the internal thermal sensor when enabled by ITHTE: 0 = (G)MCH throttling 1 = DRAM throttling |
| 5 | RO | 0b | Core | Reserved |
| 4 | R/W/L | 0b | Core | Throttling Temperature Range Selection (TTRS): This bit determines what temperature ranges will enable throttling. Lockable by bit 0 of this register. See also the throttling registers in MCHBAR configuration space COGTC and C1GTC [(G)MCH Thermal Sensor Trip Enable] and PEFC [Thermal Sensor Trip Enable] which are used to enable or disable throttling. 0 = Catastrophic only. The Catastrophic thermal temperature range will enable main memory thermal throttling. 1 = Hot and Catastrophic. |
| 3 | R/W/L | 0b | Core | Halt on Catastrophic (HOC): 0 = Continue to toggle clocks when the catastrophic sensor trips. 1 = All clocks are disabled when the catastrophic sensor trips. A system reset is required to bring the system out of a halt from the thermal sensor. |
| 2:1 | RO | 00b | Core | Reserved |
| 0 | R/W/L/K | 0b | Core | Hardware Throttling Lock Bit (HTL): This bit locks bits 7:0 of this register. 0 = The register bits are unlocked. 1 = The register bits are locked. It may only be set to a 0 by a hardware reset. Writing a 0 to this bit has no effect. |



5.2.47 TIS—Thermal Interrupt Status

B/D/F/Type: 0/0/0/MCHBAR
 Address Offset: CEA-CEBh
 Default Value: 0000h
 Access: R/WC, RO
 Size: 16 bits

This register is used to report which specific error condition resulted in the Device 0 Function 0 ERRSTS[Thermal Sensor event for SMI/SCI/SERR] or memory mapped IIR Thermal Event. Software can examine the current state of the thermal zones by examining the TSS. Software can distinguish internal or external Trip Event by examining EXTSCS.

Software must write a 1 to clear the status bits in this register.

The Following scenario is possible:

An interrupt is initiated on a rising temperature trip, the appropriate DMI cycles are generated, and eventually the software services the interrupt and sees a rising temperature trip as the cause in the status bits for the interrupts. Assume that the software then goes and clears the local interrupt status bit in the TIS register for that trip event. It is possible at this point that a falling temperature trip event occurs before the software has had the time to clear the global interrupts status bit. But since software has already looked at the status register before this event happened, software may not clear the local status flag for this event. Therefore, after the global interrupt is cleared by software, software must look at the instantaneous status in the TSS register.

All bits in this register are reset to their defaults by PLTRST#.

| Bit | Access | Default Value | RST/PWR | Description |
|-------|--------|---------------|---------|-----------------------------------------------------------------------------------------------------------------------------------------------------------------------------------------------------------------------------------------------------------------|
| 15:10 | RO | 00h | Core | Reserved |
| 9 | R/WC | 0b | Core | Was Catastrophic Thermal Sensor Interrupt Event (WCTSIE): 1 = Indicates a Catastrophic Thermal Sensor trip based on a higher to lower temperature transition through the trip point 0 = No trip for this event |
| 8 | R/WC | 0b | Core | Was Hot Thermal Sensor Interrupt Event (WHTSIE): 1 = Indicates a Hot Thermal Sensor trip based on a higher to lower temperature transition through the trip point 0 = No trip for this event |
| 7 | R/WC | 0b | Core | Was Aux0 Thermal Sensor Interrupt Event (WAOTSIE): 1 = Indicates an Aux0 Thermal Sensor trip based on a higher to lower temperature transition through the trip point 0 = No trip for this event Software must write a 1 to clear this status bit. |
| 6:5 | RO | 00b | Core | Reserved |



| Bit | Access | Default Value | RST/PWR | Description |
|-----|--------|---------------|---------|-------------------------------------------------------------------------------------------------------------------------------------------------------------------------------------------------------------------------------------------------------------------------------------------------------------------------|
| 4 | R/WC | 0b | Core | <p>Catastrophic Thermal Sensor Interrupt Event (CTSIE): 1 = Indicates a Catastrophic Thermal Sensor trip event occurred based on a lower to higher temperature transition through the trip point. 0 = No trip for this event Software must write a 1 to clear this status bit.</p> |
| 3 | R/WC | 0b | Core | <p>Hot Thermal Sensor Interrupt Event (HTSIE): 1 = Indicates a Hot Thermal Sensor trip event occurred based on a lower to higher temperature transition through the trip point. 0 = No trip for this event Software must write a 1 to clear this status bit.</p> |
| 2 | R/WC | 0b | Core | <p>Aux0 Thermal Sensor Interrupt Event (A0TSIE): 1 = Indicates an Aux0 Thermal Sensor trip event occurred based on a lower to higher temperature transition through the trip point. 0 = No trip for this event Software must write a 1 to clear this status bit.</p> |
| 1:0 | RO | 00b | Core | Reserved |



5.2.48 TSMICMD—Thermal SMI Command

B/D/F/Type: 0/0/0/MCHBAR
 Address Offset: CF1h
 Default Value: 00h
 Access: RO, R/W
 Size: 8 bits

This register selects specific errors to generate a SMI DMI special cycle, as enabled by the Device 0 SMI Error Command Register [SMI on (G)MCH Thermal Sensor Trip]. The SMI must not be enabled at the same time as the SERR/SCI for the thermal sensor event.

All bits in this register are reset to their defaults by PLTRST#.

| Bit | Access | Default Value | RST/PWR | Description |
|-----|--------|---------------|---------|---------------------------------------------------------------------------------------------------------------------------------------------------------------------------------------------------------------------------------------|
| 7:3 | RO | 00h | Core | Reserved |
| 2 | R/W | 0b | Core | SMI on (G)MCH Catastrophic Thermal Sensor Trip (SMGCTST): 1 = Does not mask the generation of an SMI DMI special cycle on a catastrophic thermal sensor trip. 0 = Disable reporting of this condition via SMI messaging. |
| 1 | R/W | 0b | Core | SMI on (G)MCH Hot Thermal Sensor Trip (SMGHTST): 1 = Does not mask the generation of an SMI DMI special cycle on a Hot thermal sensor trip. 0 = Disable reporting of this condition via SMI messaging. |
| 0 | R/W | 0b | Core | SMI on (G)MCH Aux Thermal Sensor Trip (SMGATST): 1 = Does not mask the generation of an SMI DMI special cycle on an Auxiliary thermal sensor trip. 0 = Disable reporting of this condition via SMI messaging. |



5.2.49 PMSTS—Power Management Status

B/D/F/Type: 0/0/0/MCHBAR
 Address Offset: F14-F17h
 Default Value: 00000000h
 Access: R/WC/S, RO
 Size: 32 bits

This register is Reset by PWROK only.

| Bit | Access | Default Value | RST/PWR | Description |
|------|--------|---------------|---------|---------------------------------------------------------------------------------------------------------------------------------------------------------------------------------------------------------------------------------------------------------------------------------------------------------------------------------------------------------------------------------------------------------------------------------------------------------------------------------------------------------------------------------------------------------------------------|
| 31:9 | RO | 000000h | Core | Reserved |
| 8 | R/WC/S | 0b | Core | <p>Warm Reset Occurred (WRO): Set by the PMunit whenever a Warm Reset is received, and cleared by PWROK=0. 0 = No Warm Reset occurred. 1 = Warm Reset occurred.</p> <p>BIOS Requirement: BIOS can check and clear this bit whenever executing POST code. This way BIOS knows that if the bit is set, then the PMSTS bits [1:0] must also be set, and if not BIOS needs to power-cycle the platform.</p> |
| 7:2 | RO | 00h | Core | Reserved |
| 1 | R/WC/S | 0b | Core | <p>Channel 1 in Self-Refresh (C1SR): Set by power management hardware after Channel 1 is placed in self refresh as a result of a Power State or a Reset Warn sequence. Cleared by Power management hardware before starting Channel 1 self refresh exit sequence initiated by a power management exit. Cleared by the BIOS by writing a 1 in a warm reset (Reset# asserted while PWROK is asserted) exit sequence. 0 = Channel 1 not ensured to be in self refresh. 1 = Channel 1 in Self Refresh.</p> |
| 0 | R/WC/S | 0b | Core | <p>Channel 0 in Self-Refresh (C0SR): Set by power management hardware after Channel 0 is placed in self refresh as a result of a Power State or a Reset Warn sequence. Cleared by Power management hardware before starting Channel 0 self refresh exit sequence initiated by a power management exit. Cleared by the BIOS by writing a 1 in a warm reset (Reset# asserted while PWROK is asserted) exit sequence. 0 = Channel 0 not ensured to be in self refresh. 1 = Channel 0 in Self Refresh.</p> |



5.3 EPBAR

| Address Offset | Register Symbol | Register Name | Default Value | Access |
|----------------|-----------------|-----------------------------|-----------------------|----------|
| 44–47h | EPESD | EP Element Self Description | 00000301h | RO, R/WO |
| 50–53h | EPLE1D | EP Link Entry 1 Description | 01000000h | RO, R/WO |
| 58–5Fh | EPLE1A | EP Link Entry 1 Address | 0000000000 000000h | RO, R/WO |
| 60–63h | EPLE2D | EP Link Entry 2 Description | 02000002h | RO, R/WO |
| 68–6Fh | EPLE2A | EP Link Entry 2 Address | 0000000000 008000h | RO |

5.3.1 EPESD—EP Element Self Description

B/D/F/Type: 0/0/0/PXPEPBAR
 Address Offset: 44-47h
 Default Value: 00000301h
 Access: RO, R/WO
 Size: 32 bits

This register provides information about the root complex element containing this Link Declaration Capability.

| Bit | Access | Default Value | RST/PWR | Description |
|-------|--------|---------------|---------|-----------------------------------------------------------------------------------------------------------------------------------------------------------------------------------------------------------------------------------------------|
| 31:24 | RO | 00h | Core | Port Number (PN): This field specifies the port number associated with this element with respect to the component that contains this element. A value of 00h indicates to configuration software that this is the default egress port. |
| 23:16 | R/WO | 00h | Core | Component ID (CID): This field identifies the physical component that contains this Root Complex Element. |
| 15:8 | RO | 03h | Core | Number of Link Entries (NLE): This field indicates the number of link entries following the Element Self Description. This field reports 3 (one each for PEG0, PEG1 and DMI). |
| 7:4 | RO | 0h | Core | Reserved |
| 3:0 | RO | 1h | Core | Element Type (ET): This field indicates the type of the Root Complex Element. Value of 1h represents a port to system memory. |



5.3.2 EPLE1D—EP Link Entry 1 Description

B/D/F/Type: 0/0/0/PXPEPBAR
 Address Offset: 50-53h
 Default Value: 01000000h
 Access: RO, R/WO
 Size: 32 bits

This register provides the first part of a Link Entry, which declares an internal link to another Root Complex Element.

| Bit | Access | Default Value | RST/PWR | Description |
|-------|--------|---------------|---------|------------------------------------------------------------------------------------------------------------------------------------------------------------------------------------------------------------------------------------------------------------------|
| 31:24 | RO | 01h | Core | Target Port Number (TPN): This field specifies the port number associated with the element targeted by this link entry (DMI). The target port number is with respect to the component that contains this element as specified by the target component ID. |
| 23:16 | R/WO | 00h | Core | Target Component ID (TCID): This field identifies the physical or logical component that is targeted by this link entry. |
| 15:2 | RO | 0000h | Core | Reserved |
| 1 | RO | 0b | Core | Link Type (LTYP): This bit indicates that the link points to memory-mapped space (for RCRB). The link address specifies the 64-bit base address of the target RCRB. |
| 0 | R/WO | 0b | Core | Link Valid (LV): 0 = Link Entry is not valid and will be ignored. 1 = Link Entry specifies a valid link. |

5.3.3 EPLE1A—EP Link Entry 1 Address

B/D/F/Type: 0/0/0/PXPEPBAR
 Address Offset: 58-5Fh
 Default Value: 0000000000000000h
 Access: RO, R/WO
 Size: 64 bits

This register provides the second part of a Link Entry, which declares an internal link to another Root Complex Element.

| Bit | Access | Default Value | RST/PWR | Description |
|-------|--------|---------------|---------|------------------------------------------------------------------------------------------------------------------------------------------------|
| 63:36 | RO | 0000000h | Core | Reserved: Reserved for Link Address high order bits. |
| 35:12 | R/WO | 000000h | Core | Link Address (LA): This field contains the memory mapped base address of the RCRB that is the target element (DMI) for this link entry. |
| 11:0 | RO | 000h | Core | Reserved |



5.3.4 EPLE2D—EP Link Entry 2 Description

B/D/F/Type: 0/0/0/PXPEPBAR
 Address Offset: 60-63h
 Default Value: 02000002h
 Access: RO, R/WO
 Size: 32 bits

This register provides the first part of a Link Entry, which declares an internal link to another Root Complex Element.

| Bit | Access | Default Value | RST/PWR | Description |
|-------|--------|---------------|---------|--------------------------------------------------------------------------------------------------------------------------------------------------------------------------------------------------------------------------------------------------------------------------------------|
| 31:24 | RO | 02h | Core | Target Port Number (TPN): This field specifies the port number associated with the element targeted by this link entry (PEG0). The target port number is with respect to the component that contains this element as specified by the target component ID. |
| 23:16 | R/WO | 00h | Core | Target Component ID (TCID): This field identifies the physical or logical component that is targeted by this link entry. A value of 0 is reserved. Component IDs start at 1. This value is a mirror of the value in the Component ID field of all elements in this component. |
| 15:2 | RO | 0000h | Core | Reserved |
| 1 | RO | 1b | Core | Link Type (LTYP): This bit indicates that the link points to configuration space of the integrated device which controls the x16 root port for PEG0. The link address specifies the configuration address (segment, bus, device, function) of the target root port. |
| 0 | R/WO | 0b | Core | Link Valid (LV): 0 = Link Entry is not valid and will be ignored. 1 = Link Entry specifies a valid link. |



5.3.5 EPLE2A—EP Link Entry 2 Address

B/D/F/Type: 0/0/0/PXPEPBAR
Address Offset: 68-6Fh
Default Value: 0000000000008000h
Access: RO
Size: 64 bits

This register provides the second part of a Link Entry, which declares an internal link to another Root Complex Element.

| Bit | Access | Default Value | RST/PWR | Description |
|-------|--------|---------------|---------|--------------------------------------------------------------------------------------------------------|
| 63:28 | RO | 000000000h | Core | Reserved for Configuration Space Base Address: Not required if root complex has only one config space. |
| 27:20 | RO | 00h | Core | Bus Number (BUSN): |
| 19:15 | RO | 00001b | Core | Device Number (DEVN): The target for this link is PCI Express x16 port PEG0 (Device 1). |
| 14:12 | RO | 000b | Core | Function Number (FUNN): |
| 11:0 | RO | 000h | Core | Reserved |

§ §



6 Host-PCI Express* Registers (D1:F0)

Device 1 contains the controls associated with the PCI Express x16 root port that is the intended to attach as the point for external graphics. It is typically referred to as PCI EXPRESS-G (PCI Express graphics) port. In addition, it also functions as the virtual PCI-to-PCI bridge.

Warning: When reading the PCI Express "conceptual" registers such as this, you may not get a valid value unless the register value is stable.

The *PCI Express* Specification* defines two types of reserved bits.

Reserved and Preserved:

1. Reserved for future R/W implementations; software must preserve value read for writes to bits.
2. Reserved and Zero: Reserved for future R/WC/S implementations; software must use 0 for writes to bits.

Unless explicitly documented as Reserved and Zero, all bits marked as reserved are part of the Reserved and Preserved type, which have historically been the typical definition for Reserved.

Note: Most (if not all) control bits in this device cannot be modified unless the link is down. Software is required to first Disable the link, then program the registers, and then re-enable the link (which will cause a full-retrain with the new settings).

Table 13. PCI Express* Register Address Map (D1:F0)

| Address Offset | Register Symbol | Register Name | Default Value | Access |
|----------------|-----------------|-------------------------|--------------------------|----------|
| 0–1h | VID1 | Vendor Identification | 8086h | RO |
| 2–3h | DID1 | Device Identification | see register description | RO |
| 4–5h | PCICMD1 | PCI Command | 0000h | RO, R/W |
| 6–7h | PCISTS1 | PCI Status | 0010h | RO, R/WC |
| 8h | RID1 | Revision Identification | see register description | RO |
| 9–Bh | CC1 | Class Code | 060400h | RO |
| Ch | CL1 | Cache Line Size | 00h | R/W |
| Eh | HDR1 | Header Type | 01h | RO |
| 18h | PBUSN1 | Primary Bus Number | 00h | RO |
| 19h | SBUSN1 | Secondary Bus Number | 00h | R/W |
| 1Ah | SUBUSN1 | Subordinate Bus Number | 00h | R/W |
| 1Ch | IOBASE1 | I/O Base Address | F0h | RO, R/W |
| 1Dh | IOLIMIT1 | I/O Limit Address | 00h | R/W, RO |
| 1E–1Fh | SSTS1 | Secondary Status | 0000h | R/WC, RO |
| 20–21h | MBASE1 | Memory Base Address | FFF0h | R/W, RO |

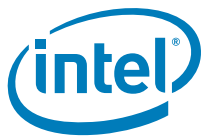

Table 13. PCI Express* Register Address Map (D1:F0)

| Address Offset | Register Symbol | Register Name | Default Value | Access |
|----------------|-----------------|-------------------------------------------|---------------|-----------------|
| 22–23h | MLIMIT1 | Memory Limit Address | 0000h | RO, R/W |
| 24–25h | PMBASE1 | Prefetchable Memory Base Address | FFF1h | R/W, RO |
| 26–27h | PMLIMIT1 | Prefetchable Memory Limit Address | 0001h | RO, R/W |
| 28–2Bh | PMBASEU1 | Prefetchable Memory Base Address Upper | 00000000h | R/W |
| 2C–2Fh | PMLIMITU1 | Prefetchable Memory Limit Address Upper | 00000000h | R/W |
| 34h | CAPPTR1 | Capabilities Pointer | 88h | RO |
| 3Ch | INTRLINE1 | Interrupt Line | 00h | R/W |
| 3Dh | INTRPIN1 | Interrupt Pin | 01h | RO |
| 3E–3Fh | BCTRL1 | Bridge Control | 0000h | RO, R/W |
| 80–83h | PM_CAPID1 | Power Management Capabilities | C8039001h | RO |
| 84–87h | PM_CS1 | Power Management Control/Status | 00000008h | RO, R/W/P, R/W |
| 88–8Bh | SS_CAPID | Subsystem ID and Vendor ID Capabilities | 0000800Dh | RO |
| 8C–8Fh | SS | Subsystem ID and Subsystem Vendor ID | 00008086h | R/WO |
| 90–91h | MSI_CAPID | Message Signaled Interrupts Capability ID | A005h | RO |
| 92–93h | MC | Message Control | 0000h | RO, R/W |
| 94–97h | MA | Message Address | 00000000h | R/W, RO |
| 98–99h | MD | Message Data | 0000h | R/W |
| A0–A1h | PEG_CAPL | PCI Express-G Capability List | 0010h | RO |
| A2–A3h | PEG_CAP | PCI Express-G Capabilities | 0142h | RO, R/WO |
| A4–A7h | DCAP | Device Capabilities | 00008000h | RO |
| A8–A9h | DCTL | Device Control | 0000h | RO, R/W |
| AA–ABh | DSTS | Device Status | 0000h | RO, R/WC |
| AC–AFh | LCAP | Link Capabilities | 02214D02h | RO, R/WO |
| B0–B1h | LCTL | Link Control | 0000h | R/W, RO, R/W/SC |
| B2–B3h | LSTS | Link Status | 1000h | R/WC, RO |
| B4–B7h | SLOTCAP | Slot Capabilities | 00040000h | R/WO, RO |
| B8–B9h | SLOTCTL | Slot Control | 0000h | RO, R/W |
| BA–BBh | SLOTSTS | Slot Status | 0000h | RO, R/WC |
| BC–BDh | RCTL | Root Control | 0000h | RO, R/W |
| C0–C3h | RSTS | Root Status | 00000000h | RO, R/WC |
| EC–EFh | PEGLC | PCI Express-G Legacy Control | 00000000h | RO, R/W |



6.1 Host-PCI Express* Register Description (D1:F0)

6.1.1 VID1—Vendor Identification

B/D/F/Type: 0/1/0/PCI
 Address Offset: 0-1h
 Default Value: 8086h
 Access: RO
 Size: 16 bits

This register, combined with the Device Identification register, uniquely identifies any PCI device.

| Bit | Access | Default Value | RST/PWR | Description |
|------|--------|---------------|---------|------------------------------------------------------------------------------|
| 15:0 | RO | 8086h | Core | Vendor Identification (VID1) : PCI standard identification for Intel. |

6.1.2 DID1—Device Identification

B/D/F/Type: 0/1/0/PCI
 Address Offset: 2-3h
 Default Value: 2E01h
 Access: RO
 Size: 16 bits

This register, combined with the Vendor Identification register, uniquely identifies any PCI device.

| Bit | Access | Default Value | RST/PWR | Description |
|------|--------|---------------|---------|-----------------------------------------------------------------------------------------------------------------------------------------------------|
| 15:8 | RO | 2Eh | Core | Device Identification Number (DID1(UB)) : Identifier assigned to the (G)MCH device 1 (virtual PCI-to-PCI bridge, PCI Express Graphics port). |
| 7:4 | RO | 0h | Core | Device Identification Number (DID1(HW)) : Identifier assigned to the (G)MCH device 1 (virtual PCI-to-PCI bridge, PCI Express Graphics port). |
| 3:0 | RO | 1h | Core | Device Identification Number (DID1(LB)) : Identifier assigned to the (G)MCH device 1 (virtual PCI-to-PCI bridge, PCI Express Graphics port). |



6.1.3 PCICMD1—PCI Command

B/D/F/Type: 0/1/0/PCI
 Address Offset: 4-5h
 Default Value: 0000h
 Access: RO, R/W
 Size: 16 bits

| Bit | Access | Default Value | RST/PWR | Description |
|-------|--------|---------------|---------|-----------------------------------------------------------------------------------------------------------------------------------------------------------------------------------------------------------------------------------------------------------------------------------------------------------------------------------------------------------------------------------------------------------------------------------------------------------------------------------------------------------------------------------------------------------------------------------------------------------------------------------------------------------------------------------------------------------------------------------------------------------------------------------------------------------------------------------------------------------------------------------------------------------------------------------------------------------------------------------------------------------------------------------------------------------------------------------------------------------------------------------------------------------------------------------------------------------------------------|
| 15:11 | RO | 00h | Core | Reserved |
| 10 | R/W | 0b | Core | <p>INTA Assertion Disable (INTAAD): 0 = This device is permitted to generate INTA interrupt messages. 1 = This device is prevented from generating interrupt messages. Any INTA emulation interrupts already asserted must be de-asserted when this bit is set.</p> <p>Only affects interrupts generated by the device (PCI INTA from a PME or Hot Plug event) controlled by this command register. It does not affect upstream MSIs, upstream PCI INTA–INTD assert and de-assert messages.</p> |
| 9 | RO | 0b | Core | <p>Fast Back-to-Back Enable (FB2B): Not Applicable or Implemented. Hardwired to 0.</p> |
| 8 | R/W | 0b | Core | <p>SERR# Message Enable (SERRE1): This bit controls Device 1 SERR# messaging. The (G)MCH communicates the SERR# condition by sending a SERR message to the ICH. This bit, when set, enables reporting of non-fatal and fatal errors detected by the device to the Root Complex. Note that errors are reported if enabled either through this bit or through the PCI-Express specific bits in the Device Control Register.</p> <p>In addition, for Type 1 configuration space header devices, this bit, when set, enables transmission by the primary interface of ERR_NONFATAL and ERR_FATAL error messages forwarded from the secondary interface. This bit does not affect the transmission of forwarded ERR_COR messages.</p> <p>0 = The SERR message is generated by the (G)MCH for Device 1 only under conditions enabled individually through the Device Control Register. 1 = The (G)MCH is enabled to generate SERR messages, which will be sent to the ICH for specific Device 1 error conditions generated/detected on the primary side of the virtual PCI to PCI bridge (not those received by the secondary side). The status of SERRs generated is reported in the PCISTS1 register.</p> |
| 7 | RO | 0b | Core | Reserved: Not Applicable or Implemented. Hardwired to 0. |
| 6 | R/W | 0b | Core | <p>Parity Error Response Enable (PERRE): This bit controls whether or not the Master Data Parity Error bit in the PCI Status register can be set.</p> <p>0 = Master Data Parity Error bit in PCI Status register can NOT be set. 1 = Master Data Parity Error bit in PCI Status register CAN be set.</p> |



| Bit | Access | Default Value | RST/PWR | Description |
|-----|--------|---------------|---------|--------------------------------------------------------------------------------------------------------------------------------------------------------------------------------------------------------------------------------------------------------------------------------------------------------------------------------------------------------------------------------------------------------------------------------------------------------------------------------------------------------------------------------------------------------------------------------------------------------------------------------------------------------------------------------------------------------------------------------------------------------------------------------------------------------------------------------------------------------------------------------------------------------------------------------------------------------------------------------------------------------------------------------------------------------------------------------------------------------------------------------------------------------------|
| 5 | RO | 0b | Core | VGA Palette Snoop (VGAPS): Not Applicable or Implemented. Hardwired to 0. |
| 4 | RO | 0b | Core | Memory Write and Invalidate Enable (MWIE): Not Applicable or Implemented. Hardwired to 0. |
| 3 | RO | 0b | Core | Special Cycle Enable (SCE): Not Applicable or Implemented. Hardwired to 0. |
| 2 | R/W | 0b | Core | <p>Bus Master Enable (BME): This bit controls the ability of the PEG port to forward Memory and IO Read/Write Requests in the upstream direction.</p> <p>0 = This device is prevented from making memory or I/O requests to its primary bus. Note that according to PCI Specification, as MSI interrupt messages are in-band memory writes, disabling the bus master enable bit prevents this device from generating MSI interrupt messages or passing them from its secondary bus to its primary bus. Upstream memory writes/reads, I/O writes/reads, peer writes/reads, and MSIs will all be treated as invalid cycles. Writes are forwarded to memory address C0000h with byte enables de-asserted. Reads are forwarded to memory address C0000h and will return Unsupported Request status (or Master abort) in its completion packet.</p> <p>1 = This device is allowed to issue requests to its primary bus. Completions for previously issued memory read requests on the primary bus will be issued when the data is available. This bit does not affect forwarding of Completions from the primary interface to the secondary interface.</p> |
| 1 | R/W | 0b | Core | <p>Memory Access Enable (MAE):</p> <p>0 = All of device 1's memory space is disabled.</p> <p>1 = Enable the Memory and Pre-fetchable memory address ranges defined in the MBASE1, MLIMIT1, PMBASE1, and PMLIMIT1 registers.</p> |
| 0 | R/W | 0b | Core | <p>IO Access Enable (IOAE):</p> <p>0 = All of device 1's I/O space is disabled.</p> <p>1 = Enable the I/O address range defined in the IOBASE1, and IOLIMIT1 registers.</p> |



6.1.4 PCISTS1—PCI Status

B/D/F/Type: 0/1/0/PCI
 Address Offset: 6-7h
 Default Value: 0010h
 Access: RO, R/WC
 Size: 16 bits

This register reports the occurrence of error conditions associated with primary side of the "virtual" Host-PCI Express bridge embedded within the (G)MCH.

| Bit | Access | Default Value | RST/PWR | Description |
|------|--------|---------------|---------|-----------------------------------------------------------------------------------------------------------------------------------------------------------------------------------------------------------------------------------------------------------------------------------------------------------------------------------------------------------------------------------------------------------------------------------------------------------------------------------------------------------------------------------------------------------------------------------------------------------------------------|
| 15 | RO | 0b | Core | Detected Parity Error (DPE): Not Applicable or Implemented. Hardwired to 0. Parity (generating poisoned TLPs) is not supported on the primary side of this device. Error forwarding is not performed. |
| 14 | R/WC | 0b | Core | Signaled System Error (SSE): This bit is set when this Device sends an SERR due to detecting an ERR_FATAL or ERR_NONFATAL condition and the SERR Enable bit in the Command register is 1. Both received (if enabled by BCTRL1[1]) and internally detected error messages do not affect this field. |
| 13 | RO | 0b | Core | Received Master Abort Status (RMAS): Not Applicable or Implemented. Hardwired to 0. The concept of a master abort does not exist on primary side of this device. |
| 12 | RO | 0b | Core | Received Target Abort Status (RTAS): Not Applicable or Implemented. Hardwired to 0. The concept of a target abort does not exist on primary side of this device. |
| 11 | RO | 0b | Core | Signaled Target Abort Status (STAS): Not Applicable or Implemented. Hardwired to 0. The concept of a target abort does not exist on primary side of this device. |
| 10:9 | RO | 00b | Core | DEVSELB Timing (DEVT): This device is not the subtractive decode device on bus 0. This bit field is therefore hardwired to 00 to indicate that the device uses the fastest possible decode. |
| 8 | RO | 0b | Core | Master Data Parity Error (PMDPE): Because the primary side of the PEG's virtual PCI-to-PCI bridge is integrated with the MCH functionality there is no scenario where this bit will get set. Because hardware will never set this bit, it is impossible for software to have an opportunity to clear this bit or otherwise test that it is implemented. The PCI specification defines it as a R/WC, but for our implementation an RO definition behaves the same way and will meet all Microsoft testing requirements. This bit can only be set when the Parity Error Enable bit in the PCI Command register is set. |
| 7 | RO | 0b | Core | Fast Back-to-Back (FB2B): Not Applicable or Implemented. Hardwired to 0. |
| 6 | RO | 0b | Core | Reserved |
| 5 | RO | 0b | Core | 66/60MHz capability (CAP66): Not Applicable or Implemented. Hardwired to 0. |



| Bit | Access | Default Value | RST/PWR | Description |
|-----|--------|---------------|---------|-------------------------------------------------------------------------------------------------------------------------------------------------------------------------------------------------------------------------------------------------------------------------------------------------------------------------------------------------------------------------------------------------|
| 4 | RO | 1b | Core | Capabilities List (CAPL): This bit indicates that a capabilities list is present. Hardwired to 1. |
| 3 | RO | 0b | Core | INTA Status (INTAS): This bit indicates that an interrupt message is pending internally to the device. Only PME and Hot Plug sources feed into this status bit (not PCI INTA-INTD assert and de-assert messages). The INTA Assertion Disable bit, PCICMD1[10], has no effect on this bit. Note that INTA emulation interrupts received across the link are not reflected in this bit. |
| 2:0 | RO | 000b | Core | Reserved |

6.1.5 RID1—Revision Identification

B/D/F/Type: 0/1/0/PCI
 Address Offset: 8h
 Default Value: see description below
 Access: RO
 Size: 8 bits

This register contains the revision number of the (G)MCH device 1. These bits are read only and writes to this register have no effect.

| Bit | Access | Default Value | RST/PWR | Description |
|-----|--------|-----------------|---------|---------------------------------------------------------------------------------------------------------------------------------------------------------------------------------------------------------------------------------------------------------|
| 7:0 | RO | see description | Core | Revision Identification Number (RID1): This is an 8-bit value that indicates the revision identification number for the (G)MCH Device 0. Refer to the <i>Intel® 4 Series Chipset Family Specification Update</i> for the value of this register. |



6.1.6 CC1—Class Code

B/D/F/Type: 0/1/0/PCI
Address Offset: 9-Bh
Default Value: 060400h
Access: RO
Size: 24 bits

This register identifies the basic function of the device, a more specific sub-class, and a register- specific programming interface.

| Bit | Access | Default Value | RST/PWR | Description |
|-------|--------|---------------|---------|---------------------------------------------------------------------------------------------------------------------------------------------------------------------------------------------------------------|
| 23:16 | RO | 06h | Core | Base Class Code (BCC): This field indicates the base class code for this device. 06h = Bridge device. |
| 15:8 | RO | 04h | Core | Sub-Class Code (SUBCC): This field indicates the sub-class code for this device. 04h = PCI-to-PCI Bridge. |
| 7:0 | RO | 00h | Core | Programming Interface (PI): This field indicates the programming interface of this device. This value does not specify a particular register set layout and provides no practical use for this device. |

6.1.7 CL1—Cache Line Size

B/D/F/Type: 0/1/0/PCI
Address Offset: Ch
Default Value: 00h
Access: R/W
Size: 8 bits

| Bit | Access | Default Value | RST/PWR | Description |
|-----|--------|---------------|---------|-----------------------------------------------------------------------------------------------------------------------------------------------------------------------------------------------------------|
| 7:0 | R/W | 00h | Core | Cache Line Size (Scratch pad): This field is implemented by PCI Express devices as a read-write field for legacy compatibility purposes but has no impact on any PCI Express device functionality. |



6.1.8 HDR1—Header Type

B/D/F/Type: 0/1/0/PCI
 Address Offset: Eh
 Default Value: 01h
 Access: RO
 Size: 8 bits

This register identifies the header layout of the configuration space. No physical register exists at this location.

| Bit | Access | Default Value | RST/PWR | Description |
|-----|--------|---------------|---------|----------------------------------------------------------------------------------------------------------------------------------------|
| 7:0 | RO | 01h | Core | Header Type Register (HDR): This field returns 01h to indicate that this is a single function device with bridge header layout. |

6.1.9 PBUSN1—Primary Bus Number

B/D/F/Type: 0/1/0/PCI
 Address Offset: 18h
 Default Value: 00h
 Access: RO
 Size: 8 bits

This register identifies that this "virtual" Host-PCI Express bridge is connected to PCI bus 0.

| Bit | Access | Default Value | RST/PWR | Description |
|-----|--------|---------------|---------|-----------------------------------------------------------------------------------------------------------------------------------------------------------------------------------------------------------------------------------------------------------------------------|
| 7:0 | RO | 00h | Core | Primary Bus Number (BUSN): Configuration software typically programs this field with the number of the bus on the primary side of the bridge. Since device 1 is an internal device and its primary bus is always 0, these bits are read only and are hardwired to 0. |

6.1.10 SBUSN1—Secondary Bus Number

B/D/F/Type: 0/1/0/PCI
 Address Offset: 19h
 Default Value: 00h
 Access: R/W
 Size: 8 bits

This register identifies the bus number assigned to the second bus side of the "virtual" bridge (i.e., to PCI Express). This number is programmed by the PCI configuration software to allow mapping of configuration cycles to PCI Express.

| Bit | Access | Default Value | RST/PWR | Description |
|-----|--------|---------------|---------|-------------------------------------------------------------------------------------------------------------------------------------|
| 7:0 | R/W | 00h | Core | Secondary Bus Number (BUSN): This field is programmed by configuration software with the bus number assigned to PCI Express. |



6.1.11 SUBUSN1—Subordinate Bus Number

B/D/F/Type: 0/1/0/PCI
Address Offset: 1Ah
Default Value: 00h
Access: R/W
Size: 8 bits

This register identifies the subordinate bus (if any) that resides at the level below PCI Express. This number is programmed by the PCI configuration software to allow mapping of configuration cycles to PCI Express.

| Bit | Access | Default Value | RST/PWR | Description |
|-----|--------|---------------|---------|----------------------------------------------------------------------------------------------------------------------------------------------------------------------------------------------------------------------------------------------------------------------------------------------------------------------|
| 7:0 | R/W | 00h | Core | Subordinate Bus Number (BUSN): This register is programmed by configuration software with the number of the highest subordinate bus that lies behind the device 1 bridge. When only a single PCI device resides on the PCI Express segment, this register will contain the same value as the SBUSN1 register. |

6.1.12 IOBASE1—I/O Base Address

B/D/F/Type: 0/1/0/PCI
Address Offset: 1Ch
Default Value: F0h
Access: RO, R/W
Size: 8 bits

This register controls the processor to PCI Express I/O access routing based on the following formula:

$$\text{IO_BASE} \leq \text{address} \leq \text{IO_LIMIT}$$

Only upper 4 bits are programmable. For the purpose of address decode, address bits A[11:0] are treated as 0. Thus, the bottom of the defined I/O address range will be aligned to a 4 KB boundary.

| Bit | Access | Default Value | RST/PWR | Description |
|-----|--------|---------------|---------|-------------------------------------------------------------------------------------------------------------------------------------------------------------------------------------------------------------------------------------------------------------------------------------|
| 7:4 | R/W | Fh | Core | I/O Address Base (IOBASE): This field corresponds to A[15:12] of the I/O addresses passed by bridge 1 to PCI Express. BIOS must not set this register to 00h; otherwise, 0CF8h/0CFCh accesses will be forwarded to the PCI Express hierarchy associated with this device. |
| 3:0 | RO | 0h | Core | Reserved |



6.1.13 IOLIMIT1—I/O Limit Address

B/D/F/Type: 0/1/0/PCI
 Address Offset: 1Dh
 Default Value: 00h
 Access: R/W, RO
 Size: 8 bits

This register controls the processor-to-PCI Express I/O access routing based on the following formula:

$$IO_BASE \leq \text{address} \leq IO_LIMIT$$

Only upper 4 bits are programmable. For the purpose of address decode, address bits A[11:0] are assumed to be FFFh. Thus, the top of the defined I/O address range will be at the top of a 4 KB aligned address block.

| Bit | Access | Default Value | RST/PWR | Description |
|-----|--------|---------------|---------|-------------------------------------------------------------------------------------------------------------------------------------------------------------------------------------------------------------------------------------|
| 7:4 | R/W | 0h | Core | I/O Address Limit (IOLIMIT) : This field corresponds to A[15:12] of the I/O address limit of device 1. Devices between this upper limit and IOBASE1 will be passed to the PCI Express hierarchy associated with this device. |
| 3:0 | RO | 0h | Core | Reserved |

6.1.14 SSTS1—Secondary Status

B/D/F/Type: 0/1/0/PCI
 Address Offset: 1E-1Fh
 Default Value: 0000h
 Access: R/WC, RO
 Size: 16 bits

SSTS1 is a 16-bit status register that reports the occurrence of error conditions associated with secondary side (i.e., PCI Express-G side) of the "virtual" PCI-PCI bridge in the (G)MCH.

| Bit | Access | Default Value | RST/PWR | Description |
|-----|--------|---------------|---------|----------------------------------------------------------------------------------------------------------------------------------------------------------------------------------------------------------------------------------------------------------------|
| 15 | R/WC | 0b | Core | Detected Parity Error (DPE) : This bit is set by the Secondary Side for a Type 1 Configuration Space header device whenever it receives a Poisoned TLP, regardless of the state of the Parity Error Response Enable bit in the Bridge Control Register. |
| 14 | R/WC | 0b | Core | Received System Error (RSE) : This bit is set when the Secondary Side for a Type 1 configuration space header device receives an ERR_FATAL or ERR_NONFATAL. |
| 13 | R/WC | 0b | Core | Received Master Abort (RMA) : This bit is set when the Secondary Side for Type 1 Configuration Space Header Device (for requests initiated by the Type 1 Header Device itself) receives a Completion with Unsupported Request Completion Status. |



| Bit | Access | Default Value | RST/PWR | Description |
|------|--------|---------------|---------|---------------------------------------------------------------------------------------------------------------------------------------------------------------------------------------------------------------------------------------------------------------------|
| 12 | R/WC | 0b | Core | Received Target Abort (RTA): This bit is set when the Secondary Side for Type 1 Configuration Space Header Device (for requests initiated by the Type 1 Header Device itself) receives a Completion with Completer Abort Completion Status. |
| 11 | RO | 0b | Core | Signaled Target Abort (STA): Not Applicable or Implemented. Hardwired to 0. The (G)MCH does not generate Target Aborts (the (G)MCH will never complete a request using the Completer Abort Completion status. |
| 10:9 | RO | 00b | Core | DEVSELB Timing (DEVT): Not Applicable or Implemented. Hardwired to 0. |
| 8 | R/WC | 0b | Core | Master Data Parity Error (SMDPE): When set, this bit indicates that the MCH received across the link (upstream) a Read Data Completion Poisoned TLP (EP=1). This bit can only be set when the Parity Error Enable bit in the Bridge Control register is set. |
| 7 | RO | 0b | Core | Fast Back-to-Back (FB2B): Not Applicable or Implemented. Hardwired to 0. |
| 6 | RO | 0b | Core | Reserved |
| 5 | RO | 0b | Core | 66/60 MHz capability (CAP66): Not Applicable or Implemented. Hardwired to 0. |
| 4:0 | RO | 00h | Core | Reserved |

6.1.15 MBASE1—Memory Base Address

B/D/F/Type: 0/1/0/PCI
 Address Offset: 20-21h
 Default Value: FFF0h
 Access: R/W, RO
 Size: 16 bits

This register controls the processor to PCI Express non-prefetchable memory access routing based on the following formula:

$$\text{MEMORY_BASE} \leq \text{address} \leq \text{MEMORY_LIMIT}$$

The upper 12 bits of the register are read/write and correspond to the upper 12 address bits A[31:20] of the 32 bit address. The bottom 4 bits of this register are read-only and return zeroes when read. This register must be initialized by the configuration software. For the purpose of address decode, address bits A[19:0] are assumed to be 0. Thus, the bottom of the defined memory address range will be aligned to a 1 MB boundary.

| Bit | Access | Default Value | RST/PWR | Description |
|------|--------|---------------|---------|---------------------------------------------------------------------------------------------------------------------------------------------------|
| 15:4 | R/W | FFFh | Core | Memory Address Base (MBASE): This field corresponds to A[31:20] of the lower limit of the memory range that will be passed to PCI Express. |
| 3:0 | RO | 0h | Core | Reserved |



6.1.16 MLIMIT1—Memory Limit Address

| | |
|-----------------|-----------|
| B/D/F/Type: | 0/1/0/PCI |
| Address Offset: | 22-23h |
| Default Value: | 0000h |
| Access: | RO, R/W |
| Size: | 16 bits |

This register controls the processor to PCI Express non-prefetchable memory access routing based on the following formula:

$$\text{MEMORY_BASE} \leq \text{address} \leq \text{MEMORY_LIMIT}$$

The upper 12 bits of the register are read/write and correspond to the upper 12 address bits A[31:20] of the 32 bit address. The bottom 4 bits of this register are read-only and return zeroes when read. This register must be initialized by the configuration software. For the purpose of address decode, address bits A[19:0] are assumed to be FFFFh. Thus, the top of the defined memory address range will be at the top of a 1 MB aligned memory block.

Note: Memory range covered by MBASE and MLIMIT registers are used to map non-prefetchable PCI Express address ranges (typically where control/status memory-mapped I/O data structures of the graphics controller will reside) and PMBASE and PMLIMIT are used to map prefetchable address ranges (typically graphics local memory). This segregation allows application of USWC space attribute to be performed in a true plug-and-play manner to the prefetchable address range for improved processor- PCI Express memory access performance.

Note: Configuration software is responsible for programming all address range registers (prefetchable, non-prefetchable) with the values that provide exclusive address ranges i.e. prevent overlap with each other and/or with the ranges covered with the main memory. There is no provision in the (G)MCH hardware to enforce prevention of overlap and operations of the system in the case of overlap are not ensured.

| Bit | Access | Default Value | RST/PWR | Description |
|------|--------|---------------|---------|-----------------------------------------------------------------------------------------------------------------------------------------|
| 15:4 | R/W | 000h | Core | Memory Address Limit (MLIMIT): This field corresponds to A[31:20] of the upper limit of the address range passed to PCI Express. |
| 3:0 | RO | 0h | Core | Reserved |



6.1.17 PMBASE1—Prefetchable Memory Base Address

B/D/F/Type: 0/1/0/PCI
Address Offset: 24-25h
Default Value: FFF1h
Access: R/W, RO
Size: 16 bits

This register in conjunction with the corresponding Upper Base Address register controls the processor to PCI Express prefetchable memory access routing based on the following formula:

$$\text{PREFETCHABLE_MEMORY_BASE} \leq \text{address} \leq \text{PREFETCHABLE_MEMORY_LIMIT}$$

The upper 12 bits of this register are read/write and correspond to address bits A[31:20] of the 40-bit address. The lower 8 bits of the Upper Base Address register are read/write and correspond to address bits A[39:32] of the 40-bit address. This register must be initialized by the configuration software. For the purpose of address decode, address bits A[19:0] are assumed to be 0. Thus, the bottom of the defined memory address range will be aligned to a 1 MB boundary.

| Bit | Access | Default Value | RST/PWR | Description |
|------|--------|---------------|---------|---------------------------------------------------------------------------------------------------------------------------------------------------------------------------------------------------------------------------------|
| 15:4 | R/W | FFFh | Core | Prefetchable Memory Base Address (MBASE): This field corresponds to A[31:20] of the lower limit of the memory range that will be passed to PCI Express. |
| 3:0 | RO | 1h | Core | 64-bit Address Support (64-bit Address Support): This field indicates that the upper 32 bits of the prefetchable memory region base address are contained in the Prefetchable Memory base Upper Address register at 28h. |



6.1.18 PMLIMIT1—Prefetchable Memory Limit Address

B/D/F/Type: 0/1/0/PCI
 Address Offset: 26-27h
 Default Value: 0001h
 Access: RO, R/W
 Size: 16 bits

This register in conjunction with the corresponding Upper Limit Address register controls the processor to PCI Express prefetchable memory access routing based on the following formula:

$$\text{PREFETCHABLE_MEMORY_BASE} \leq \text{address} \leq \text{PREFETCHABLE_MEMORY_LIMIT}$$

The upper 12 bits of this register are read/write and correspond to address bits A[31:20] of the 40-bit address. The lower 8 bits of the Upper Limit Address register are read/write and correspond to address bits A[39:32] of the 40-bit address. This register must be initialized by the configuration software. For the purpose of address decode, address bits A[19:0] are assumed to be FFFFh. Thus, the top of the defined memory address range will be at the top of a 1 MB aligned memory block. Note that prefetchable memory range is supported to allow segregation by the configuration software between the memory ranges that must be defined as UC and the ones that can be designated as a USWC (i.e., prefetchable) from the processor perspective.

| Bit | Access | Default Value | RST/ PWR | Description |
|------|--------|---------------|-------------|----------------------------------------------------------------------------------------------------------------------------------------------------------------------------------------------------------------------------------|
| 15:4 | R/W | 000h | Core | Prefetchable Memory Address Limit (PMLIMIT): This field corresponds to A[31:20] of the upper limit of the address range passed to PCI Express. |
| 3:0 | RO | 1h | Core | 64-bit Address Support (64-bit Address Support): This field indicates that the upper 32 bits of the prefetchable memory region limit address are contained in the Prefetchable Memory Base Limit Address register at 2Ch. |



6.1.19 PMBASEU1—Prefetchable Memory Base Address Upper

B/D/F/Type: 0/1/0/PCI
Address Offset: 28-2Bh
Default Value: 00000000h
Access: R/W
Size: 32 bits

The functionality associated with this register is present in the PEG design implementation.

This register in conjunction with the corresponding Upper Base Address register controls the processor to PCI Express prefetchable memory access routing based on the following formula:

$$\text{PREFETCHABLE_MEMORY_BASE} \leq \text{address} \leq \text{PREFETCHABLE_MEMORY_LIMIT}$$

The upper 12 bits of this register are read/write and correspond to address bits A[31:20] of the 40-bit address. The lower 8 bits of the Upper Base Address register are read/write and correspond to address bits A[39:32] of the 40-bit address. This register must be initialized by the configuration software. For the purpose of address decode, address bits A[19:0] are assumed to be 0. Thus, the bottom of the defined memory address range will be aligned to a 1 MB boundary.

| Bit | Access | Default Value | RST/PWR | Description |
|------|--------|---------------|---------|------------------------------------------------------------------------------------------------------------------------------------------------------------------------------|
| 31:0 | R/W | 00000000h | Core | Prefetchable Memory Base Address (MBASEU): This field corresponds to A[63:32] of the lower limit of the prefetchable memory range that will be passed to PCI Express. |



6.1.20 PMLIMITU1—Prefetchable Memory Limit Address Upper

B/D/F/Type: 0/1/0/PCI
 Address Offset: 2C-2Fh
 Default Value: 00000000h
 Access: R/W
 Size: 32 bits

The functionality associated with this register is present in the PEG design implementation.

This register in conjunction with the corresponding Upper Limit Address register controls the processor to PCI Express prefetchable memory access routing based on the following formula:

$$\text{PREFETCHABLE_MEMORY_BASE} \leq \text{address} \leq \text{PREFETCHABLE_MEMORY_LIMIT}$$

The upper 12 bits of this register are read/write and correspond to address bits A[31:20] of the 40-bit address. The lower 8 bits of the Upper Limit Address register are read/write and correspond to address bits A[39:32] of the 40-bit address. This register must be initialized by the configuration software. For the purpose of address decode, address bits A[19:0] are assumed to be FFFFh. Thus, the top of the defined memory address range will be at the top of a 1 MB aligned memory block.

Note that prefetchable memory range is supported to allow segregation by the configuration software between the memory ranges that must be defined as UC and the ones that can be designated as a USWC (i.e., prefetchable) from the processor perspective.

| Bit | Access | Default Value | RST/PWR | Description |
|------|--------|---------------|---------|--------------------------------------------------------------------------------------------------------------------------------------------------------------------------------|
| 31:0 | R/W | 00000000h | Core | Prefetchable Memory Address Limit (MLIMITU): This field corresponds to A[63:32] of the upper limit of the prefetchable Memory range that will be passed to PCI Express. |

6.1.21 CAPPTR1—Capabilities Pointer

B/D/F/Type: 0/1/0/PCI
 Address Offset: 34h
 Default Value: 88h
 Access: RO
 Size: 8 bits

The capabilities pointer provides the address offset to the location of the first entry in this device's linked list of capabilities.

| Bit | Access | Default Value | RST/PWR | Description |
|-----|--------|---------------|---------|-----------------------------------------------------------------------------------------------------------------------------|
| 7:0 | RO | 88h | Core | First Capability (CAPPTR1): The first capability in the list is the Subsystem ID and Subsystem Vendor ID Capability. |



6.1.22 INTRLINE1—Interrupt Line

B/D/F/Type: 0/1/0/PCI
Address Offset: 3Ch
Default Value: 00h
Access: R/W
Size: 8 bits

This register contains interrupt line routing information. The device itself does not use this value, rather it is used by device drivers and operating systems to determine priority and vector information.

| Bit | Access | Default Value | RST/PWR | Description |
|-----|--------|---------------|---------|----------------------------------------------------------------------------------------------------------------------------------------------------------------------------------------------------------------------------------------------------------------------------------------------------------------------------------------------------------------------|
| 7:0 | R/W | 00h | Core | Interrupt Connection (INTCON): This field is used to communicate interrupt line routing information. BIOS Requirement: POST software writes the routing information into this register as it initializes and configures the system. The value indicates to which input of the system interrupt controller this device's interrupt pin is connected. |

6.1.23 INTRPIN1—Interrupt Pin

B/D/F/Type: 0/1/0/PCI
Address Offset: 3Dh
Default Value: 01h
Access: RO
Size: 8 bits

This register specifies which interrupt pin this device uses.

| Bit | Access | Default Value | RST/PWR | Description |
|-----|--------|---------------|---------|------------------------------------------------------------------------------------------------------------------------------------|
| 7:0 | RO | 01h | Core | Interrupt Pin (INTRPIN): As a single function device, the PCI Express device specifies INTA as its interrupt pin. 01h=INTA. |



6.1.24 BCTRL1—Bridge Control

B/D/F/Type: 0/1/0/PCI
 Address Offset: 3E-3Fh
 Default Value: 0000h
 Access: RO, R/W
 Size: 16 bits

This register provides extensions to the PCICMD1 register that are specific to PCI-PCI bridges. The BCTRL provides additional control for the secondary interface (i.e., PCI Express) as well as some bits that affect the overall behavior of the "virtual" Host-PCI Express bridge in the (G)MCH (e.g., VGA compatible address ranges mapping).

| Bit | Access | Default Value | RST/PWR | Description |
|-------|--------|---------------|---------|-----------------------------------------------------------------------------------------------------------------------------------------------------------------------------------------------------------------------------------------------------------------------------------------------------------------------------------------------------------------------------------------------------------------------------------------|
| 15:12 | RO | 0h | Core | Reserved |
| 11 | RO | 0b | Core | Discard Timer SERR# Enable (DTSERRE) : Not Applicable or Implemented. Hardwired to 0. |
| 10 | RO | 0b | Core | Discard Timer Status (DTSTS) : Not Applicable or Implemented. Hardwired to 0. |
| 9 | RO | 0b | Core | Secondary Discard Timer (SDT) : Not Applicable or Implemented. Hardwired to 0. |
| 8 | RO | 0b | Core | Primary Discard Timer (PDT) : Not Applicable or Implemented. Hardwired to 0. |
| 7 | RO | 0b | Core | Fast Back-to-Back Enable (FB2BEN) : Not Applicable or Implemented. Hardwired to 0. |
| 6 | R/W | 0b | Core | Secondary Bus Reset (SRESET) : Setting this bit triggers a hot reset on the corresponding PCI Express Port. This will force the LTSSM to transition to the Hot Reset state (via Recovery) from L0 or L1 states. |
| 5 | RO | 0b | Core | Master Abort Mode (MAMODE) : Does not apply to PCI Express. Hardwired to 0. |
| 4 | R/W | 0b | Core | VGA 16-bit Decode (VGA16D) : Enables the PCI-to-PCI bridge to provide 16-bit decoding of VGA I/O address precluding the decoding of alias addresses every 1 KB. This bit only has meaning if bit 3 (VGA Enable) of this register is also set to 1, enabling VGA I/O decoding and forwarding by the bridge. 0 = Execute 10-bit address decodes on VGA I/O accesses. 1 = Execute 16-bit address decodes on VGA I/O accesses. |
| 3 | R/W | 0b | Core | VGA Enable (VGAEN) : This bit controls the routing of processor-initiated transactions targeting VGA compatible I/O and memory address ranges. See the VGAEN/MDAP table in device 0, offset 97h[0]. |



| Bit | Access | Default Value | RST/PWR | Description |
|-----|--------|---------------|---------|------------------------------------------------------------------------------------------------------------------------------------------------------------------------------------------------------------------------------------------------------------------------------------------------------------------------------------------------------------------------------------------------------------------------------------------------------------------------------------------------------------------------------------------------------------------------------------------------------------------------------------------------------------------------------------|
| 2 | R/W | 0b | Core | <p>ISA Enable (ISAEN): This bit is needed to exclude legacy resource decode to route ISA resources to legacy decode path. Modifies the response by the (G)MCH to an I/O access issued by the processor that target ISA I/O addresses. This applies only to I/O addresses that are enabled by the IOBASE and IOLIMIT registers.</p> <p>0 = All addresses defined by the IOBASE and IOLIMIT for processor I/O transactions will be mapped to PCI Express.</p> <p>1 = (G)MCH will not forward to PCI Express any I/O transactions addressing the last 768 bytes in each 1 KB block even if the addresses are within the range defined by the IOBASE and IOLIMIT registers.</p> |
| 1 | R/W | 0b | Core | <p>SERR Enable (SERREN):</p> <p>0 = No forwarding of error messages from secondary side to primary side that could result in an SERR.</p> <p>1 = ERR_COR, ERR_NONFATAL, and ERR_FATAL messages result in SERR message when individually enabled by the Root Control register.</p> |
| 0 | R/W | 0b | Core | <p>Parity Error Response Enable (PEREN): This bit controls whether or not the Master Data Parity Error bit in the Secondary Status register is set when the MCH receives across the link (upstream) a Read Data Completion Poisoned TLP.</p> <p>0 = Master Data Parity Error bit in Secondary Status register can NOT be set.</p> <p>1 = Master Data Parity Error bit in Secondary Status register CAN be set.</p> |



6.1.25 PM_CAPID1—Power Management Capabilities

B/D/F/Type: 0/1/0/PCI
 Address Offset: 80-83h
 Default Value: C8039001h
 Access: RO
 Size: 32 bits

| Bit | Access | Default Value | RST/PWR | Description |
|-------|--------|---------------|---------|-----------------------------------------------------------------------------------------------------------------------------------------------------------------------------------------------------------------------------------------------------------------------------------------------------------------------------------------------------------------------------------------------------------------|
| 31:27 | RO | 19h | Core | PME Support (PMES): This field indicates the power states in which this device may indicate PME wake via PCI Express messaging. D0, D3hot & D3cold. This device is not required to do anything to support D3hot & D3cold, it simply must report that those states are supported. Refer to the <i>PCI Power Management 1.1 Specification</i> for encoding explanation and other power management details. |
| 26 | RO | 0b | Core | D2 Power State Support (D2PSS): Hardwired to 0 to indicate that the D2 power management state is NOT supported. |
| 25 | RO | 0b | Core | D1 Power State Support (D1PSS): Hardwired to 0 to indicate that the D1 power management state is NOT supported. |
| 24:22 | RO | 000b | Core | Auxiliary Current (AUXC): Hardwired to 0 to indicate that there are no 3.3Vaux auxiliary current requirements. |
| 21 | RO | 0b | Core | Device Specific Initialization (DSI): Hardwired to 0 to indicate that special initialization of this device is NOT required before generic class device driver is to use it. |
| 20 | RO | 0b | Core | Auxiliary Power Source (APS): Hardwired to 0. |
| 19 | RO | 0b | Core | PME Clock (PMECLK): Hardwired to 0 to indicate this device does NOT support PMEB generation. |
| 18:16 | RO | 011b | Core | PCI PM CAP Version (PCIPMCV): A value of 011b indicates that this function complies with revision 1.2 of the <i>PCI Power Management Interface Specification</i> . |
| 15:8 | RO | 90h | Core | Pointer to Next Capability (PNC): This field contains a pointer to the next item in the capabilities list. If MSICH (CAPL[0] @ 7Fh) is 0, then the next item in the capabilities list is the Message Signaled Interrupts (MSI) capability at 90h. If MSICH (CAPL[0] @ 7Fh) is 1, then the next item in the capabilities list is the PCI Express capability at A0h. |
| 7:0 | RO | 01h | Core | Capability ID (CID): Value of 01h identifies this linked list item (capability structure) as being for PCI Power Management registers. |



6.1.26 PM_CS1—Power Management Control/Status

B/D/F/Type: 0/1/0/PCI
 Address Offset: 84-87h
 Default Value: 00000008h
 Access: RO, R/W/P, R/W
 Size: 32 bits

| Bit | Access | Default Value | RST/PWR | Description |
|-------|--------|---------------|---------|-----------------------------------------------------------------------------------------------------------------------------------------------------------------------------------------------------------------------------------------------------------------------------------------------------------------------------------------------------------------------------------------------------------------------------------------------------------------------------------------------------------------------------------------------------------------------------------------------------------------------------------------------------------------------------------------------------------------------------------------------|
| 31:16 | RO | 0000h | Core | Reserved: Not Applicable or Implemented. Hardwired to 0. |
| 15 | RO | 0b | Core | PME Status (PMESTS): This bit indicates that this device does not support PMEB generation from D3cold. |
| 14:13 | RO | 00b | Core | Data Scale (DSCALE): This bit indicates that this device does not support the power management data register. |
| 12:9 | RO | 0h | Core | Data Select (DSEL): This bit indicates that this device does not support the power management data register. |
| 8 | R/W/P | 0b | Core | PME Enable (PMEE): This bit indicates that this device does not generate PMEB assertion from any D-state. 0 = PMEB generation not possible from any D State 1 = PMEB generation enabled from any D State The setting of this bit has no effect on hardware. See PM_CAP[15:11] |
| 7:4 | RO | 0000b | Core | Reserved |
| 3 | RO | 1b | Core | No Soft Reset (NSR): When set to 1 this bit indicates that the device is transitioning from D3hot to D0 because the power state commands do not perform an internal reset. Configuration context is preserved. Upon transition no additional operating system intervention is required to preserve configuration context beyond writing the power state bits. When clear the devices do not perform an internal reset upon transitioning from D3hot to D0 via software control of the power state bits. Regardless of this bit the devices that transition from a D3hot-to-D0 by a system or bus segment reset will return to the device state D0 uninitialized with only PME context preserved if PME is supported and enabled. |
| 2 | RO | 0b | Core | Reserved |



| Bit | Access | Default Value | RST/PWR | Description |
|-----|--------|---------------|---------|-----------------------------------------------------------------------------------------------------------------------------------------------------------------------------------------------------------------------------------------------------------------------------------------------------------------------------------------------------------------------------------------------------------------------------------------------------------------------------------------------------------------------------------------------------------------------------------------------------------------------------------------------------------------------------------------------------------------------------------------------------------------------------------------------------------------------------------------------------------------------------------------------------------------------------------------------------------------------------------------------------------------------------------------------------------------------------------------------------------------------------------------------------------------------------------------------------------|
| 1:0 | R/W | 00b | Core | <p>Power State (PS): This field indicates the current power state of this device and can be used to set the device into a new power state. If software attempts to write an unsupported state to this field, write operation must complete normally on the bus, but the data is discarded and no state change occurs.</p> <p>00 = D0 01 = D1 (Not supported) 10 = D2 (Not supported) 11 = D3</p> <p>Support of D3cold does not require any special action. While in the D3hot state, this device can only act as the target of PCI configuration transactions (for power management control). This device also cannot generate interrupts or respond to MMR cycles in the D3 state. The device must return to the D0 state in order to be fully-functional.</p> <p>When the Power State is other than D0, the bridge will Master Abort (i.e. not claim) any downstream cycles (with exception of type 0 config cycles). Consequently, these unclaimed cycles will go down DMI and come back up as Unsupported Requests, which the MCH logs as Master Aborts in Device 0 PCISTS[13]</p> <p>There is no additional hardware functionality required to support these Power States.</p> |

6.1.27 SS_CAPID—Subsystem ID and Vendor ID Capabilities

B/D/F/Type: 0/1/0/PCI
Address Offset: 88-8Bh
Default Value: 0000800Dh
Access: RO
Size: 32 bits

This capability is used to uniquely identify the subsystem where the PCI device resides. Because this device is an integrated part of the system and not an add-in device, it is anticipated that this capability will never be used. However, it is necessary because Microsoft will test for its presence.

| Bit | Access | Default Value | RST/PWR | Description |
|-------|--------|---------------|---------|----------------------------------------------------------------------------------------------------------------------------------------------------------------|
| 31:16 | RO | 0000h | Core | Reserved |
| 15:8 | RO | 80h | Core | Pointer to Next Capability (PNC): This field contains a pointer to the next item in the capabilities list which is the PCI Power Management capability. |
| 7:0 | RO | 0Dh | Core | Capability ID (CID): Value of 0Dh identifies this linked list item (capability structure) as being for SSID/SSVID registers in a PCI-to-PCI Bridge. |

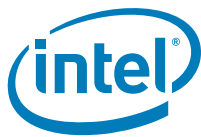

6.1.28 SS—Subsystem ID and Subsystem Vendor ID

B/D/F/Type: 0/1/0/PCI
Address Offset: 8C-8Fh
Default Value: 00008086h
Access: R/WO
Size: 32 bits

System BIOS can be used as the mechanism for loading the SSID/SVID values. These values must be preserved through power management transitions and a hardware reset.

| Bit | Access | Default Value | RST/PWR | Description |
|-------|--------|---------------|---------|-----------------------------------------------------------------------------------------------------------------------------------------------------------------------------------|
| 31:16 | R/WO | 0000h | Core | Subsystem ID (SSID): This field identifies the particular subsystem and is assigned by the vendor. |
| 15:0 | R/WO | 8086h | Core | Subsystem Vendor ID (SSVID): This field identifies the manufacturer of the subsystem and is the same as the vendor ID which is assigned by the PCI Special Interest Group. |

6.1.29 MSI_CAPID—Message Signaled Interrupts Capability ID

B/D/F/Type: 0/1/0/PCI
Address Offset: 90-91h
Default Value: A005h
Access: RO
Size: 16 bits

When a device supports MSI, it can generate an interrupt request to the processor by writing a predefined data item (a message) to a predefined memory address.

The reporting of the existence of this capability can be disabled by setting MSICH (CAPL[0] @ 7Fh). In that case walking this linked list will skip this capability and instead go directly from the PCI PM capability to the PCI Express capability.

| Bit | Access | Default Value | RST/PWR | Description |
|------|--------|---------------|---------|-------------------------------------------------------------------------------------------------------------------------------------------------------|
| 15:8 | RO | A0h | Core | Pointer to Next Capability (PNC): This field contains a pointer to the next item in the capabilities list which is the PCI Express capability. |
| 7:0 | RO | 05h | Core | Capability ID (CID): Value of 05h identifies this linked list item (capability structure) as being for MSI registers. |



6.1.30 MC—Message Control

B/D/F/Type: 0/1/0/PCI
 Address Offset: 92-93h
 Default Value: 0000h
 Access: RO, R/W
 Size: 16 bits

System software can modify bits in this register, but the device is prohibited from modifying bits.

If the device writes the same message multiple times, only one of those messages is ensured to be serviced. If all of them must be serviced, the device must not generate the same message again until the driver services the earlier one.

| Bit | Access | Default Value | RST/PWR | Description |
|------|--------|---------------|---------|---------------------------------------------------------------------------------------------------------------------------------------------------------------------------------------------------------------------------------------------------------------------------------------------------------------------------------|
| 15:8 | RO | 00h | Core | Reserved |
| 7 | RO | 0b | Core | 64-bit Address Capable (64AC): Hardwired to 0 to indicate that the function does not implement the upper 32 bits of the Message Address register and is incapable of generating a 64-bit memory address. This may need to change in future implementations when addressable system memory exceeds the 32b/4 GB limit. |
| 6:4 | R/W | 000b | Core | Multiple Message Enable (MME): System software programs this field to indicate the actual number of messages allocated to this device. This number will be equal to or less than the number actually requested. The encoding is the same as for the MMC field below. |
| 3:1 | RO | 000b | Core | Multiple Message Capable (MMC): System software reads this field to determine the number of messages being requested by this device. 000 = 1 All other encodings are reserved. |
| 0 | R/W | 0b | Core | MSI Enable (MSIEN): This bit controls the ability of this device to generate MSIs. 0 = MSI will not be generated. 1 = MSI will be generated when we receive PME or HotPlug messages. INTA will not be generated and INTA Status (PCISTS1[3]) will not be set. |



6.1.31 MA—Message Address

B/D/F/Type: 0/1/0/PCI
 Address Offset: 94-97h
 Default Value: 00000000h
 Access: R/W, RO
 Size: 32 bits

| Bit | Access | Default Value | RST/PWR | Description |
|------|--------|---------------|---------|---------------------------------------------------------------------------------------------------------------------------------------------------------------------------------------------------------|
| 31:2 | R/W | 00000000h | Core | Message Address (MA): This field is used by system software to assign an MSI address to the device. The device handles an MSI by writing the padded contents of the MD register to this address. |
| 1:0 | RO | 00b | Core | Force DWord Align (FDWA): Hardwired to 0 so that addresses assigned by system software are always aligned on a dword address boundary. |

6.1.32 MD—Message Data

B/D/F/Type: 0/1/0/PCI
 Address Offset: 98-99h
 Default Value: 0000h
 Access: R/W
 Size: 16 bits

| Bit | Access | Default Value | RST/PWR | Description |
|------|--------|---------------|---------|------------------------------------------------------------------------------------------------------------------------------------------------------------------------------------------------------------------------------------------------------------------------------------------------------------------------------------------------------------------------------|
| 15:0 | R/W | 0000h | Core | Message Data (MD): This field is the base message data pattern assigned by system software and used to handle an MSI from the device. When the device must generate an interrupt request, it writes a 32-bit value to the memory address specified in the MA register. The upper 16 bits are always set to 0. The lower 16 bits are supplied by this register. |

6.1.33 PEG_CAPL—PCI Express-G Capability List

B/D/F/Type: 0/1/0/PCI
 Address Offset: A0-A1h
 Default Value: 0010h
 Access: RO
 Size: 16 bits

This register enumerates the PCI Express capability structure.

| Bit | Access | Default Value | RST/PWR | Description |
|------|--------|---------------|---------|-----------------------------------------------------------------------------------------------------------------------------------------------------------------------------------------------------------------------------------------------------------------------------------------------------------------|
| 15:8 | RO | 00h | Core | Pointer to Next Capability (PNC): This value terminates the capabilities list. The Virtual Channel capability and any other PCI Express specific capabilities that are reported via this mechanism are in a separate capabilities list located entirely within PCI Express Extended Configuration Space. |
| 7:0 | RO | 10h | Core | Capability ID (CID): This field identifies this linked list item (capability structure) as being for PCI Express registers. |



6.1.34 PEG_CAP—PCI Express-G Capabilities

B/D/F/Type: 0/1/0/PCI
 Address Offset: A2-A3h
 Default Value: 0142h
 Access: RO, R/WO
 Size: 16 bits

This register indicates PCI Express device capabilities.

| Bit | Access | Default Value | RST/PWR | Description |
|-------|--------|---------------|---------|---------------------------------------------------------------------------------------------------------------------------------------------------------------------------------------------------------------------------------------------------------------------------------------------------------------------------------------------|
| 15:14 | RO | 0b | Core | Reserved |
| 13:9 | RO | 00h | Core | Interrupt Message Number (IMN): Not Applicable or Implemented. Hardwired to 0. |
| 8 | R/WO | 1b | Core | Slot Implemented (SI): 0 = The PCI Express Link associated with this port is connected to an integrated component or is disabled. 1 = The PCI Express Link associated with this port is connected to a slot. BIOS Requirement: This field must be initialized appropriately if a slot connection is not implemented. |
| 7:4 | RO | 4h | Core | Device/Port Type (DPT): Hardwired to 4h to indicate root port of PCI Express Root Complex. |
| 3:0 | RO | 2h | Core | PCI Express Capability Version (PCIECV): Hardwired to 2h to indicate compliance to the PCI Express Capabilities Register Expansion ECN. |

6.1.35 DCAP—Device Capabilities

B/D/F/Type: 0/1/0/PCI
 Address Offset: A4-A7h
 Default Value: 00008000h
 Access: RO
 Size: 32 bits

This register indicates PCI Express device capabilities.

| Bit | Access | Default Value | RST/PWR | Description |
|-------|--------|---------------|---------|---------------------------------------------------------------------------------------------------------------------------------------------------------------------------------------------------------|
| 31:16 | RO | 0000h | Core | Reserved: Not Applicable or Implemented. Hardwired to 0. |
| 15 | RO | 1b | Core | Role Based Error Reporting (RBER): This bit indicates that this device implements the functionality defined in the Error Reporting ECN as required by the <i>PCI Express 1.1 Specification</i> . |
| 14:6 | RO | 000h | Core | Reserved: Not Applicable or Implemented. Hardwired to 0. |
| 5 | RO | 0b | Core | Extended Tag Field Supported (ETFS): Hardwired to indicate support for 5-bit Tags as a Requestor. |
| 4:3 | RO | 00b | Core | Phantom Functions Supported (PFS): Not Applicable or Implemented. Hardwired to 0. |
| 2:0 | RO | 000b | Core | Max Payload Size (MPS): Hardwired to indicate 128B max supported payload for Transaction Layer Packets (TLP). |



6.1.36 DCTL—Device Control

B/D/F/Type: 0/1/0/PCI
 Address Offset: A8-A9h
 Default Value: 0000h
 Access: RO, R/W
 Size: 16 bits

This register provides control for PCI Express device specific capabilities.

The error reporting enable bits are in reference to errors detected by this device, not error messages received across the link. The reporting of error messages (ERR_CORR, ERR_NONFATAL, ERR_FATAL) received by Root Port is controlled exclusively by Root Port Command Register.

| Bit | Access | Default Value | RST/PWR | Description |
|------|--------|---------------|---------|----------------------------------------------------------------------------------------------------------------------------------------------------------------------------------------------------------------------------------------------------------------------------------------------------------------------------------------------------------------------------------------------------------------------------------------------------------------------------------------------------------------------------------------|
| 15:8 | RO | 0s | Core | Reserved |
| 7:5 | R/W | 000b | Core | Max Payload Size (MPS): 000 = 128B max supported payload for Transaction Layer Packets (TLP). As a receiver, the Device must handle TLPs as large as the set value, as transmitter, the Device must not generate TLPs exceeding the set value. All other encodings are reserved. Hardware will actually ignore this field. It is writeable only to support compliance testing. |
| 4 | RO | 0b | Core | Reserved for Enable Relaxed Ordering |
| 3 | R/W | 0b | Core | Unsupported Request Reporting Enable (URRE): Unsupported Request Reporting Enable (URRE): When set, this bit allows signaling ERR_NONFATAL, ERR_FATAL, or ERR_CORR to the Root Control register when detecting an unmasked Unsupported Request (UR). An ERR_CORR is signaled when an unmasked Advisory Non-Fatal UR is received. An ERR_FATAL or ERR_NONFATAL is sent to the Root Control register when an uncorrectable non-Advisory UR is received with the severity bit set in the Uncorrectable Error Severity register. |
| 2 | R/W | 0b | Core | Fatal Error Reporting Enable (FERE): Fatal Error Reporting Enable (FERE): When set, enables signaling of ERR_FATAL to the Root Control register due to internally detected errors or error messages received across the link. Other bits also control the full scope of related error reporting. |
| 1 | R/W | 0b | Core | Non-Fatal Error Reporting Enable (NERE): Non-Fatal Error Reporting Enable (NERE): When set, enables signaling of ERR_NONFATAL to the Root Control register due to internally detected errors or error messages received across the link. Other bits also control the full scope of related error reporting. |
| 0 | R/W | 0b | Core | Correctable Error Reporting Enable (CERE): Correctable Error Reporting Enable (CERE): When set, this bit enables signaling of ERR_CORR to the Root Control register due to internally detected errors or error messages received across the link. Other bits also control the full scope of related error reporting. |



6.1.37 DSTS—Device Status

B/D/F/Type: 0/1/0/PCI
 Address Offset: AA-ABh
 Default Value: 0000h
 Access: RO, R/WC
 Size: 16 bits

This register reflects status corresponding to controls in the Device Control register. The error reporting bits are in reference to errors detected by this device, not errors messages received across the link.

| Bit | Access | Default Value | RST/PWR | Description |
|------|--------|---------------|---------|-------------------------------------------------------------------------------------------------------------------------------------------------------------------------------------------------------------------------------------------------------------------------------------------------------------------------------------------------------------------------------------------------------------------------------------------------------------------------------------------------------------------------------------------|
| 15:6 | RO | 000h | Core | Reserved and Zero: For future R/WC/S implementations; software must use 0 for writes to bits. |
| 5 | RO | 0b | Core | Transactions Pending (TP): 0 = All pending transactions (including completions for any outstanding non-posted requests on any used virtual channel) have been completed. 1 = Indicates that the device has transaction(s) pending (including completions for any outstanding non-posted requests for all used Traffic Classes). |
| 4 | RO | 0b | Core | Reserved |
| 3 | R/WC | 0b | Core | Unsupported Request Detected (URD): When set, this bit indicates that the Device received an Unsupported Request. Errors are logged in this register regardless of whether error reporting is enabled or not in the Device Control Register. Additionally, the Non-Fatal Error Detected bit or the Fatal Error Detected bit is set according to the setting of the Unsupported Request Error Severity bit. In production systems setting the Fatal Error Detected bit is not an option as support for AER will not be reported. |
| 2 | R/WC | 0b | Core | Fatal Error Detected (FED): When set, this bit indicates that fatal error(s) were detected. Errors are logged in this register regardless of whether error reporting is enabled or not in the Device Control register. When Advanced Error Handling is enabled, errors are logged in this register regardless of the settings of the uncorrectable error mask register. |
| 1 | R/WC | 0b | Core | Non-Fatal Error Detected (NFED): When set, this bit indicates that non-fatal error(s) were detected. Errors are logged in this register regardless of whether error reporting is enabled or not in the Device Control register. When Advanced Error Handling is enabled, errors are logged in this register regardless of the settings of the uncorrectable error mask register. |
| 0 | R/WC | 0b | Core | Correctable Error Detected (CED): When set, this bit indicates that correctable error(s) were detected. Errors are logged in this register regardless of whether error reporting is enabled or not in the Device Control register. When Advanced Error Handling is enabled, errors are logged in this register regardless of the settings of the correctable error mask register. |



6.1.38 LCAP—Link Capabilities

B/D/F/Type: 0/1/0/PCI
 Address Offset: AC-AFh
 Default Value: 02214D02h
 Access: RO, R/WO
 Size: 32 bits

This register indicates PCI Express device specific capabilities.

| Bit | Access | Default Value | RST/PWR | Description |
|-------|--------|---------------|---------|-------------------------------------------------------------------------------------------------------------------------------------------------------------------------------------------------------------------------------------------------------------------------------------------------------------------------------------------------------------------------------------------------------------------------------------------------------------------------------------------------------------------------------------------------------------|
| 31:24 | RO | 02h | Core | Port Number (PN): This field indicates the PCI Express port number for the given PCI Express link. This field matches the value in Element Self Description[31:24]. |
| 23:22 | RO | 00b | Core | Reserved |
| 21 | RO | 1b | Core | Link Bandwidth Notification Capability (LBNC): A value of 1b indicates support for the Link Bandwidth Notification status and interrupt mechanisms. This capability is required for all Root Ports and Switch downstream ports supporting Links wider than x1 and/or multiple Link speeds. This field is not applicable and is reserved for Endpoint devices, PCI Express to PCI/PCI-X bridges, and Upstream Ports of Switches. Devices that do not implement the Link Bandwidth Notification capability must hardwire this bit to 0b. |
| 20 | RO | 0b | Core | Data Link Layer Link Active Reporting Capable (DLLARC): For a Downstream Port, this bit must be set to 1b if the component supports the optional capability of reporting the DL_Active state of the Data Link Control and Management State Machine. For a hot-plug capable Downstream Port (as indicated by the Hot-Plug Capable field of the Slot Capabilities register), this bit must be set to 1b. For Upstream Ports and components that do not support this optional capability, this bit must be hardwired to 0b. |
| 19 | RO | 0b | Core | Surprise Down Error Reporting Capable (SDERC): For a Downstream Port, this bit must be set to 1b if the component supports the optional capability of detecting and reporting a Surprise Down error condition. For Upstream Ports and components that do not support this optional capability, this bit must be hardwired to 0b. |



| Bit | Access | Default Value | RST/PWR | Description |
|-------|--------|---------------|---------|---------------------------------------------------------------------------------------------------------------------------------------------------------------------------------------------------------------------------------------------------------------------------------------------------------------------------------------------------------------------------------------------------------------------------------------------------------------------------------------------------------------------------------------------------------------------------------------------------------------------------------------------------------------------------------------------------------------------|
| 18 | RO | 0b | Core | <p>Clock Power Management (CPM): A value of 1b in this bit indicates that the component tolerates the removal of any reference clock(s) when the link is in the L1 and L2/3 Ready link states. A value of 0b indicates the component does not have this capability and that reference clock(s) must not be removed in these link states.</p> <p>This capability is applicable only in form factors that support "clock request" (CLKREQ#) capability.</p> <p>For a multi-function device, each function indicates its capability independently. Power Management configuration software must only permit reference clock removal if all functions of the multifunction device indicate a 1b in this bit.</p> |
| 17:15 | R/WO | 010b | Core | <p>L1 Exit Latency (L1ELAT): This field indicates the length of time this Port requires to complete the transition from L1 to L0. The value 010 b indicates the range of 2 us to less than 4 us.</p> <p>BIOS Requirement: If this field is required to be any value other than the default, BIOS must initialize it accordingly.</p> <p>Both bytes of this register that contain a portion of this field must be written simultaneously in order to prevent an intermediate (and undesired) value from ever existing.</p> |
| 14:12 | RO | 100b | Core | Reserved |
| 11:10 | R/WO | 11b | Core | Active State Link PM Support (ASLPMS): The (G)MCH supports ASPM L1. |
| 9:4 | R/WO | 10h | Core | Max Link Width (MLW): This field indicates the maximum number of lanes supported for this link. |
| 3:0 | R/WO | 2h | Core | <p>Max Link Speed (MLS): Supported Link Speed – This field indicates the supported Link speed(s) of the associated Port. Defined encodings are:</p> <p>0001b = 2.5 GT/s Link speed supported</p> <p>0010b = 5.0 GT/s and 2.5GT/s Link speeds supported</p> <p>All other encodings are reserved.</p> |



6.1.39 LCTL—Link Control

B/D/F/Type: 0/1/0/PCI
 Address Offset: B0-B1h
 Default Value: 0000h
 Access: R/W, RO, R/W/SC
 Size: 16 bits

This register allows control of PCI Express link.

| Bit | Access | Default Value | RST/PWR | Description |
|-------|--------|---------------|---------|-----------------------------------------------------------------------------------------------------------------------------------------------------------------------------------------------------------------------------------------------------------------------------------------------------------------------------------------------------------------------------------------------------------------------------------------------------------------------------------------------------------------------------------------------------------------------------------------------------------------------------------------------------|
| 15:12 | RO | 0000b | Core | Reserved |
| 11 | R/W | 0b | Core | <p>Link Autonomous Bandwidth Interrupt Enable (LABIE): When Set, this bit enables the generation of an interrupt to indicate that the Link Autonomous Bandwidth Status bit has been Set.</p> <p>This bit is not applicable and is reserved for Endpoint devices, PCI Express to PCI/PCI-X bridges, and Upstream Ports of Switches.</p> <p>Devices that do not implement the Link Bandwidth Notification capability must hardwire this bit to 0b.</p> |
| 10 | R/W | 0b | Core | <p>Link Bandwidth Management Interrupt Enable (LBMIE): When Set, this bit enables the generation of an interrupt to indicate that the Link Bandwidth Management Status bit has been Set.</p> <p>This bit is not applicable and is reserved for Endpoint devices, PCI Express to PCI/PCI-X bridges, and Upstream Ports of Switches.</p> |
| 9 | RO | 0b | Core | <p>Hardware Autonomous Width Disable (HAWD): When Set, this bit disables hardware from changing the Link width for reasons other than attempting to correct unreliable Link operation by reducing Link width.</p> <p>Devices that do not implement the ability autonomously to change Link width are permitted to hardwire this bit to 0b.</p> |
| 8 | RO | 0b | Core | <p>Enable Clock Power Management (ECPM): Applicable only for form factors that support a "Clock Request" (CLKREQ#) mechanism, this enable functions as follows:</p> <p>0 = Clock power management is disabled and device must hold CLKREQ# signal low</p> <p>1 = When this bit is set to 1, the device is permitted to use CLKREQ# signal to power manage link clock according to protocol defined in appropriate form factor specification.</p> <p>Components that do not support Clock Power Management (as indicated by a 0b value in the Clock Power Management bit of the Link Capabilities Register) must hardwire this bit to 0b.</p> |
| 7 | R/W | 0b | Core | Reserved |



| Bit | Access | Default Value | RST/PWR | Description |
|-----|--------|---------------|---------|------------------------------------------------------------------------------------------------------------------------------------------------------------------------------------------------------------------------------------------------------------------------------------------------------------------------------------------------------------------------------------------------------------------------------------------------------------------------------------------------------------------------------------------------------|
| 6 | R/W | 0b | Core | <p>Common Clock Configuration (CCC): 0 = Indicates that this component and the component at the opposite end of this Link are operating with asynchronous reference clock. 1 = Indicates that this component and the component at the opposite end of this Link are operating with a distributed common reference clock. The state of this bit affects the N_FTS value advertised during link training. See PEGLOSLAT at offset 22Ch.</p> |
| 5 | R/W/SC | 0b | Core | <p>Retrain Link (RL): 0 = Normal operation. 1 = Full Link retraining is initiated by directing the Physical Layer LTSSM from L0 or L1 states to the Recovery state. This bit always returns 0 when read. This bit is cleared automatically (no need to write a 0).</p> |
| 4 | R/W | 0b | Core | <p>Link Disable (LD): 0 = Normal operation 1 = Link is disabled. Forces the LTSSM to transition to the Disabled state (via Recovery) from L0 or L1 states. Link retraining happens automatically on 0 to 1 transition, just like when coming out of reset. Writes to this bit are immediately reflected in the value read from the bit, regardless of actual Link state.</p> |
| 3 | RO | 0b | Core | <p>Read Completion Boundary (RCB): Hardwired to 0 to indicate 64 byte.</p> |
| 2 | RO | 0b | Core | Reserved |
| 1:0 | R/W | 00b | Core | <p>Active State PM (ASPM): This field controls the level of active state power management supported on the given link. 00 = Disabled 01 = Reserved 10 = L1 Entry Enabled 11 = L1 Entry Enabled</p> |

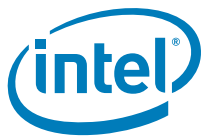

6.1.40 LSTS—Link Status

B/D/F/Type: 0/1/0/PCI
 Address Offset: B2-B3h
 Default Value: 1000h
 Access: R/WC, RO
 Size: 16 bits

This register indicates PCI Express link status.

| Bit | Access | Default Value | RST/PWR | Description |
|-----|--------|---------------|---------|---------------------------------------------------------------------------------------------------------------------------------------------------------------------------------------------------------------------------------------------------------------------------------------------------------------------------------------------------------------------------------------------------------------------------------------------------------------------------------------------------------------------------------------------------------------------------------------------------------------------------------------------------------------------------------------------------------------------------------------------------------------------------------------------------------------------------------------------------------------------------|
| 15 | R/WC | 0b | Core | <p>Link Autonomous Bandwidth Status (LABWS): This bit is set to 1b by hardware to indicate that hardware has autonomously changed link speed or width, without the port transitioning through DL_Down status, for reasons other than to attempt to correct unreliable link operation. This bit must be set if the Physical Layer reports a speed or width change was initiated by the downstream component that was indicated as an autonomous change. This bit must be set when the upstream component receives eight consecutive TS1 or TS2 ordered sets with the Autonomous Change bit set.</p> |
| 14 | R/WC | 0b | Core | <p>Link Bandwidth Management Status (LBWMS): This bit is set to 1b by hardware to indicate that either of the following has occurred without the port transitioning through DL_Down status:</p> <ul style="list-style-type: none"> A link retraining initiated by a write of 1b to the Retrain Link bit has completed. Note: This bit is Set following any write of 1b to the Retrain Link bit, including when the Link is in the process of retraining for some other reason. Hardware has autonomously changed link speed or width to attempt to correct unreliable link operation, either through an LTSSM timeout or a higher level process <p>This bit must be set if the Physical Layer reports a speed or width change was initiated by the downstream component that was not indicated as an autonomous change.</p> |
| 13 | RO | 0b | Core | <p>Data Link Layer Link Active (Optional) (DLLLA): This bit indicates the status of the Data Link Control and Management State Machine. It returns a 1b to indicate the DL_Active state, 0b otherwise. This bit must be implemented if the corresponding Data Link Layer Active Capability bit is implemented. Otherwise, this bit must be hardwired to 0b.</p> |
| 12 | RO | 1b | Core | <p>Slot Clock Configuration (SCC): 0 = The device uses an independent clock irrespective of the presence of a reference on the connector. 1 = The device uses the same physical reference clock that the platform provides on the connector.</p> |



| Bit | Access | Default Value | RST/PWR | Description |
|-----|--------|---------------|---------|--------------------------------------------------------------------------------------------------------------------------------------------------------------------------------------------------------------------------------------------------------------------------------------------------------------------------------|
| 11 | RO | 0b | Core | Link Training (LTRN): This bit indicates that the Physical Layer LTSSM is in the Configuration or Recovery state, or that 1b was written to the Retrain Link bit but Link training has not yet begun. Hardware clears this bit when the LTSSM exits the Configuration/Recovery state once Link training is complete. |
| 10 | RO | 0b | Core | Undefined (Undefined): The value read from this bit is undefined. In previous versions of this specification, this bit was used to indicate a Link Training Error. System software must ignore the value read from this bit. System software is permitted to write any value to this bit. |
| 9:4 | RO | 00h | Core | Negotiated Link Width (NLW): This field indicates negotiated link width. This field is valid only when the link is in the L0 or L1 states (after link width negotiation is successfully completed). 00h = Reserved 01h = X1 02h = X2 04h = X4 08h = X8 10h = X16 All other encodings are reserved. |
| 3:0 | RO | 0h | Core | Current Link Speed (CLS): This field indicates the negotiated Link speed of the given PCI Express Link. 0001b = 2.5 GT/s PCI Express Link 0010b = 5 GT/s PCI Express Link All other encodings are reserved. The value in this field is undefined when the Link is not up. |



6.1.41 SLOTCAP—Slot Capabilities

B/D/F/Type: 0/1/0/PCI
 Address Offset: B4-B7h
 Default Value: 00040000h
 Access: R/WO, RO
 Size: 32 bits

PCI Express Slot related registers allow for the support of Hot Plug.

| Bit | Access | Default Value | RST/PWR | Description |
|-------|--------|---------------|---------|-------------------------------------------------------------------------------------------------------------------------------------------------------------------------------------------------------------------------------------------------------------------------------------------------------------------------------------------------------------------------------------------|
| 31:19 | R/WO | 0000h | Core | Physical Slot Number (PSN): This field indicates the physical slot number attached to this Port. BIOS Requirement: This field must be initialized by BIOS to a value that assigns a slot number that is globally unique within the chassis. |
| 18 | R/WO | 1b | Core | No Command Completed Support (NCCS): When set to 1b, this bit indicates that this slot does not generate software notification when an issued command is completed by the Hot-Plug Controller. This bit is only permitted to be set to 1b if the hotplug capable port is able to accept writes to all fields of the Slot Control register without delay between successive writes. |
| 17 | RO | 0b | Core | Reserved |
| 16:15 | R/WO | 00b | Core | Slot Power Limit Scale (SPLS): This field specifies the scale used for the Slot Power Limit Value. 00 = 1.0x 01 = 0.1x 10 = 0.01x 11 = 0.001x If this field is written, the link sends a Set_Slot_Power_Limit message. |
| 14:7 | R/WO | 00h | Core | Slot Power Limit Value (SPLV): In combination with the Slot Power Limit Scale value, this field specifies the upper limit on power supplied by slot. Power limit (in Watts) is calculated by multiplying the value in this field by the value in the Slot Power Limit Scale field. If this field is written, the link sends a Set_Slot_Power_Limit message. |
| 6:0 | RO | 0b | Core | Reserved |

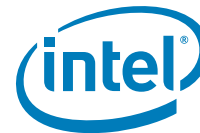

6.1.42 SLOTCTL—Slot Control

B/D/F/Type: 0/1/0/PCI
 Address Offset: B8-B9h
 Default Value: 0000h
 Access: RO, R/W
 Size: 16 bits

PCI Express Slot related registers allow for the support of Hot Plug.

| Bit | Access | Default Value | RST/PWR | Description |
|------|--------|---------------|---------|------------------------------------------------------------------------------------------------------------------------------------------|
| 15:4 | RO | 0s | Core | Reserved |
| 3 | R/W | 0b | Core | Presence Detect Changed Enable (PDCE): When set to 1b, this bit enables software notification on a presence detect changed event. |
| 2:0 | RO | 000b | Core | Reserved |



6.1.43 SLOTSTS—Slot Status

B/D/F/Type: 0/1/0/PCI
 Address Offset: BA-BBh
 Default Value: 0000h
 Access: RO, R/WC
 Size: 16 bits

PCI Express Slot related registers allow for the support of Hot Plug.

| Bit | Access | Default Value | RST/ PWR | Description |
|------|--------|---------------|-------------|-----------------------------------------------------------------------------------------------------------------------------------------------------------------------------------------------------------------------------------------------------------------------------------------------------------------------------------------------------------------------------------------------------------------------------------------------------------------------------------------------------------------------------------------------------------------------------------------------------------------------------------------------------------------------------------------------------------------------------------------------------------------------------------------------------------------------------------------------------------------------------------------------------------------------------|
| 15:9 | RO | 0000000b | Core | Reserved and Zero: For future R/WC/S implementations; software must use 0 for writes to bits. |
| 8:7 | RO | 00b | Core | Reserved |
| 6 | RO | 0b | Core | <p>Presence Detect State (PDS): In band presence detect state: 0 = Slot Empty 1 = Card present in slot</p> <p>This bit indicates the presence of an adapter in the slot, reflected by the logical "OR" of the Physical Layer in-band presence detect mechanism and, if present, any out-of-band presence detect mechanism defined for the slot's corresponding form factor. Note that the in-band presence detect mechanism requires that power be applied to an adapter for its presence to be detected. Consequently, form factors that require a power controller for hot-plug must implement a physical pin presence detect mechanism.</p> <p>This bit must be implemented on all Downstream Ports that implement slots. For Downstream Ports not connected to slots (where the Slot Implemented bit of the PCI Express Capabilities Register is 0b), this bit must return 1b.</p> |
| 5:4 | RO | 00b | Core | Reserved |
| 3 | R/WC | 0b | Core | <p>Presence Detect Changed (PDC): A pulse indication that the inband presence detect state has changed.</p> <p>This bit is set when the value reported in Presence Detect State is changed.</p> |
| 2:0 | RO | 000b | Core | Reserved |



6.1.44 RCTL—Root Control

B/D/F/Type: 0/1/0/PCI
 Address Offset: BC-BDh
 Default Value: 0000h
 Access: RO, R/W
 Size: 16 bits

This register allows control of PCI Express Root Complex specific parameters. The system error control bits in this register determine if corresponding SERRs are generated when our device detects an error (reported in this device's Device Status register) or when an error message is received across the link. Reporting of SERR as controlled by these bits takes precedence over the SERR Enable in the PCI Command Register.

| Bit | Access | Default Value | RST/PWR | Description |
|------|--------|---------------|---------|-----------------------------------------------------------------------------------------------------------------------------------------------------------------------------------------------------------------------------------------------------------------------------------------------------------------------------------------------------------------------------------------|
| 15:4 | RO | 0s | Core | Reserved |
| 3 | R/W | 0b | Core | PME Interrupt Enable (PMEIE): 0 = No interrupts are generated as a result of receiving PME messages. 1 = Enables interrupt generation upon receipt of a PME message as reflected in the PME Status bit of the Root Status Register. A PME interrupt is also generated if the PME Status bit of the Root Status Register is set when this bit is set from a cleared state. |
| 2 | R/W | 0b | Core | System Error on Fatal Error Enable (SEFEE): This bit controls the Root Complex's response to fatal errors. 0 = No SERR generated on receipt of fatal error. 1 = Indicates that an SERR should be generated if a fatal error is reported by any of the devices in the hierarchy associated with this Root Port, or by the Root Port itself. |
| 1 | R/W | 0b | Core | System Error on Non-Fatal Uncorrectable Error Enable (SENFUEE): This bit controls the Root Complex's response to non-fatal errors. 0 = No SERR generated on receipt of non-fatal error. 1 = Indicates that an SERR should be generated if a non-fatal error is reported by any of the devices in the hierarchy associated with this Root Port, or by the Root Port itself. |
| 0 | R/W | 0b | Core | System Error on Correctable Error Enable (SECEE): This bit controls the Root Complex's response to correctable errors. 0 = No SERR generated on receipt of correctable error. 1 = Indicates that an SERR should be generated if a correctable error is reported by any of the devices in the hierarchy associated with this Root Port, or by the Root Port itself. |



6.1.45 RSTS—Root Status

B/D/F/Type: 0/1/0/PCI
 Address Offset: C0-C3h
 Default Value: 00000000h
 Access: RO, R/WC
 Size: 32 bits

This register provides information about PCI Express Root Complex specific parameters.

| Bit | Access | Default Value | RST/PWR | Description |
|-------|--------|---------------|---------|-----------------------------------------------------------------------------------------------------------------------------------------------------------------------------------------------------------------------------------------------------------------------------------------------------------------------------------------------------|
| 31:18 | RO | 0000h | Core | Reserved and Zero: For future R/WC/S implementations; software must use 0 for writes to bits. |
| 17 | RO | 0b | Core | PME Pending (PMEP): This bit indicates that another PME is pending when the PME Status bit is set. When the PME Status bit is cleared by software; the PME is delivered by hardware by setting the PME Status bit again and updating the Requestor ID appropriately. The PME pending bit is cleared by hardware if no more PMEs are pending. |
| 16 | R/WC | 0b | Core | PME Status (PMES): This bit indicates that PME was asserted by the requestor ID indicated in the PME Requestor ID field. Subsequent PMEs are kept pending until the status register is cleared by writing a 1 to this field. |
| 15:0 | RO | 0000h | Core | PME Requestor ID (PMERID): This field indicates the PCI requestor ID of the last PME requestor. |

6.1.46 DCAP2—Device Capabilities 2

B/D/F/Type: 0/1/0/PCI
 Address Offset: C4-C7h
 Default Value: 00000000h
 Access: RO
 Size: 32 bits

| Bit | Access | Default Value | RST/PWR | Description |
|------|--------|---------------|---------|-------------|
| 31:0 | RO | 00000000h | Core | Reserved |

6.1.47 DCTL2—Device Control 2

B/D/F/Type: 0/1/0/PCI
 Address Offset: C8-C9h
 Default Value: 0000h
 Access: RO
 Size: 16 bits

| Bit | Access | Default Value | RST/PWR | Description |
|------|--------|---------------|---------|-------------|
| 15:0 | RO | 0000h | Core | Reserved |



6.1.48 DSTS2—Device Status 2

B/D/F/Type: 0/1/0/PCI
 Address Offset: CA-CBh
 Default Value: 0000h
 Access: RO
 Size: 16 bits

| Bit | Access | Default Value | RST/PWR | Description |
|------|--------|---------------|---------|-------------|
| 15:0 | RO | 0000h | Core | Reserved |

6.1.49 LCAP2—Link Capabilities 2

B/D/F/Type: 0/1/0/PCI
 Address Offset: CC-CFh
 Default Value: 00000000h
 Access: RO
 Size: 32 bits

| Bit | Access | Default Value | RST/PWR | Description |
|------|--------|---------------|---------|-------------|
| 31:0 | RO | 00000000h | Core | Reserved |



6.1.50 LCTL2—Link Control 2

B/D/F/Type: 0/1/0/PCI
 Address Offset: D0-D1h
 Default Value: 0002h
 Access: R/W/P, R/W, RO
 Size: 16 bits

| Bit | Access | Default Value | RST/PWR | Description |
|-------|--------|---------------|---------|---------------------------------------------------------------------------------------------------------------------------------------------------------------------------------------------------------------------------------------------------------------------------------------------------------------------------------------------------------------------------------------------------------------------------------------------------------------------------------------------------------------------------------------------------------------------------------------------------------------------------------------------------------------------------------------------------------------------------------------------------------------------------------------------------------------------|
| 15:13 | RO | 000b | Core | Reserved |
| 12 | R/W/P | 0b | Core | <p>Compliance De-emphasis: This bit sets the de-emphasis level in Polling.Compliance state if the entry occurred due to the Enter Compliance bit being 1b.</p> <p>1 = 3.5 dB 0 = 6 dB</p> <p>When the Link is operating at 2.5 GT/s, the setting of this bit has no effect. Components that support only 2.5 GT/s speed are permitted to hardwire this bit to 0b.</p> <p>For a Multi-Function device associated with an Upstream Port, the bit in Function 0 is of type R/WS, and only Function 0 controls the component's Link behavior. In all other Functions of that device, this bit is of type RSVD.</p> <p>This bit is intended for debug, compliance testing purposes.</p> <p>System firmware and software is allowed to modify this bit only during debug or compliance testing.</p> |
| 11 | R/W/P | 0b | Core | <p>Compliance SOS (composos): When set to 1b, the LTSSM is required to send SKP Ordered Sets periodically in between the (modified) compliance patterns.</p> <p>For a Multi-Function device associated with an Upstream Port, the bit in Function 0 is of type R/WS, and only Function 0 controls the component's Link behavior. In all other Functions of that device, this bit is of type RSVD.</p> <p>Components that support only the 2.5 GT/s speed are permitted to hardwire this field to 0b.</p> |
| 10 | R/W/P | 0b | Core | <p>Enter Modified Compliance (entermodcompliance): When this bit is set to 1b, the device transmits modified compliance pattern if the LTSSM enters Polling.Compliance state.</p> <p>Components that support only the 2.5GT/s speed are permitted to hardwire this bit to 0b.</p> |



| Bit | Access | Default Value | RST/PWR | Description |
|-----|--------|---------------|---------|------------------------------------------------------------------------------------------------------------------------------------------------------------------------------------------------------------------------------------------------------------------------------------------------------------------------------------------------------------------------------------------------------------------------------------------------------------------------------------------------------------------------------------------------------------------------------------------------------------------------------------------------------------------------------------------------------------------------------------------------------------------------------------------------------------------------------------------------------------------------------------------------------------------|
| 9:7 | R/W/P | 000b | Core | <p>Transmit Margin (txmargin): This field controls the value of the non-deemphasized voltage level at the Transmitter pins. This field is reset to 000b on entry to the LTSSM Polling.Configuration substates.</p> <p>000 = Normal operating range</p> <p>001 = 800–1200 mV for full swing and 400–700 mV for half-swing</p> <p>010 – (n-1) = Values must be monotonic with a non-zero slope. The value of n must be greater than 3 and less than 7. At least two of these must be below the normal operating range</p> <p>n = 200–400 mV for full-swing and 100–200 mV for half-swing</p> <p>n – 111 = reserved</p> <p>Components that support only the 2.5 GT/s speed are permitted to hardwire this bit to 0b.</p> <p>When operating in 5 GT/s mode with full swing, the deemphasis ratio must be maintained within ±1 dB from the specification defined operational value (either -3.5 or -6 dB).</p> |
| 6 | R/W/P | 0b | Core | <p>Selectable De-emphasis (selectabledeemphasis): When the Link is operating at 5 GT/s speed, selects the level of de-emphasis.</p> <p>1 = 3.5 dB</p> <p>0 = 6 dB</p> <p>Default value is implementation specific, unless a specific value is required for a selected form factor or platform.</p> <p>When the Link is operating at 2.5 GT/s speed, the setting of this bit has no effect. Components that support only the 2.5 GT/s speed are permitted to hardwire this bit to 0b.</p> |
| 5 | R/W | 0b | Core | <p>Hardware Autonomous Speed Disable (HASD): When set to 1, this bit disables hardware from changing the link speed for reasons other than attempting to correct unreliable link operation by reducing link speed.</p> |
| 4 | R/W/P | 0b | Core | <p>Enter Compliance (EC): Software is permitted to force a link to enter Compliance mode at the speed indicated in the Target Link Speed field by setting this bit to 1 in both components on a link and then initiating a hot reset on the link.</p> |



| Bit | Access | Default Value | RST/PWR | Description |
|-----|--------|---------------|---------|----------------------------------------------------------------------------------------------------------------------------------------------------------------------------------------------------------------------------------------------------------------------------------------------------------------------------------------------------------------------------------------------------------------------------------------------------------------------------------------------------------------------------------------------------------------------------------------------------------------------------------------------------------------------------------------------------------------------------------------------------------------------------------------------------------------------------------------------------------------------------------------------------------------------------------------------------------------------------------|
| 3:0 | R/W | 2h | Core | <p>Target Link Speed (TLS): For Downstream ports, this field sets an upper limit on link operational speed by restricting the values advertised by the upstream component in its training sequences.</p> <p>0001 = 2.5 Gb/s Target Link Speed 0010 = 5 Gb/s Target Link Speed All other encodings are reserved.</p> <p>If a value is written to this field that does not correspond to a speed included in the Supported Link Speeds field, the result is undefined.</p> <p>The default value of this field is the highest link speed supported by the component (as reported in the Supported Link Speeds field of the Link Capabilities Register) unless the corresponding platform / form factor requires a different default value.</p> <p>For both Upstream and Downstream ports, this field is used to set the target compliance mode speed when software is using the Enter Compliance bit to force a link into compliance mode.</p> |

6.1.51 LSTS2—Link Status 2

B/D/F/Type: 0/1/0/PCI
 Address Offset: D2-D3h
 Default Value: 0000h
 Access: RO
 Size: 16 bits

| Bit | Access | Default Value | RST/PWR | Description |
|------|--------|---------------|---------|--------------------------------------------------------------------------------------------------------------------------------------------------------------------------------------------------------------------------------------------------------|
| 15:1 | RO | 0000h | Core | Reserved |
| 0 | RO | 0b | Core | <p>Current De-emphasis Level (CURDELVL): When the Link is operating at 5 GT/s speed, this reflects the level of de-emphasis.</p> <p>1 = 3.5 dB 0 = 6 dB</p> <p>When the Link is operating at 2.5 GT/s speed, this bit is 0b.</p> |



6.1.52 SCAP2—Slot Capabilities 2

B/D/F/Type: 0/1/0/PCI
 Address Offset: D4-D7h
 Default Value: 00000000h
 Access: RO
 Size: 32 bits

| Bit | Access | Default Value | RST/PWR | Description |
|------|--------|---------------|---------|-------------|
| 31:0 | RO | 00000000h | Core | Reserved |

6.1.53 SCTL2—Slot Control 2

B/D/F/Type: 0/1/0/PCI
 Address Offset: D8-D9h
 Default Value: 0000h
 Access: RO
 Size: 16 bits

| Bit | Access | Default Value | RST/PWR | Description |
|------|--------|---------------|---------|-------------|
| 15:0 | RO | 0000h | Core | Reserved |

6.1.54 SSTS2—Slot Status 2

B/D/F/Type: 0/1/0/PCI
 Address Offset: DA-DBh
 Default Value: 0000h
 Access: RO
 Size: 16 bits

| Bit | Access | Default Value | RST/PWR | Description |
|------|--------|---------------|---------|-------------|
| 15:0 | RO | 0000h | Core | Reserved |

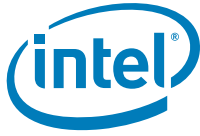

6.1.55 PEGLC—PCI Express-G Legacy Control

B/D/F/Type: 0/1/0/PCI
 Address Offset: EC-EFh
 Default Value: 00000000h
 Access: RO, R/W
 Size: 32 bits

This register controls functionality that is needed by Legacy (non-PCI Express aware) operating systems during run time.

| Bit | Access | Default Value | RST/PWR | Description |
|------|--------|---------------|---------|----------------------------------------------------------------------------------------------------------------------------------------------------------------------------------------------------------------------------------------------------------------------------------------------------------------------------------------------------------------------------------------------------------------------------------------------------------------------------------|
| 31:3 | RO | 00000000h | Core | Reserved |
| 2 | R/W | 0b | Core | PME GPE Enable (PMEGPE): 0 = Do not generate GPE PME message when PME is received. 1 = Generate a GPE PME message when PME is received (Assert_PMEGPE and Deassert_PMEGPE messages on DMI). This enables the MCH to support PMEs on the PEG port under legacy OSs. |
| 1 | R/W | 0b | Core | Hot-Plug GPE Enable (HPGPE): 0 = Do not generate GPE Hot-Plug message when Hot-Plug event is received. 1 = Generate a GPE Hot-Plug message when Hot-Plug Event is received (Assert_HPGPE and Deassert_HPGPE messages on DMI). This enables the MCH to support Hot-Plug on the PEG port under legacy OSs. |
| 0 | R/W | 0b | Core | General Message GPE Enable (GENGPE): 0 = Do not forward received GPE assert/deassert messages. 1 = Forward received GPE assert/deassert messages. These general GPE message can be received via the PEG port from an external Intel device (i.e., PxH) and will be subsequently forwarded to the ICH (via Assert_GPE and Deassert_GPE messages on DMI). For example, PxH might send this message if a PCI Express device is hot plugged into a PxH downstream port. |

§ §



7 Direct Memory Interface Registers (DMIBAR)

| Address Offset | Register Symbol | Register Name | Default Value | Access |
|----------------|-----------------|-----------------------------------------|---------------|----------|
| 0–3h | DMIVCECH | DMI Virtual Channel Enhanced Capability | 04010002h | RO |
| 4–7h | DMIPVCCAP1 | DMI Port VC Capability Register 1 | 00000001h | RO, R/WO |
| 8–Bh | DMIPVCCAP2 | DMI Port VC Capability Register 2 | 00000000h | RO |
| C–Dh | DMIPVCCTL | DMI Port VC Control | 0000h | RO, R/W |
| 10–13h | DMIVC0RCAP | DMI VC0 Resource Capability | 00000001h | RO |
| 14–17h | DMIVC0RCTL0 | DMI VC0 Resource Control | 800000FFh | RO, R/W |
| 1A–1Bh | DMIVC0RSTS | DMI VC0 Resource Status | 0002h | RO |
| 1C–1Fh | DMIVC1RCAP | DMI VC1 Resource Capability | 00008001h | RO |
| 20–23h | DMIVC1RCTL1 | DMI VC1 Resource Control | 01000000h | R/W, RO |
| 26–27h | DMIVC1RSTS | DMI VC1 Resource Status | 0002h | RO |
| 84–87h | DMILCAP | DMI Link Capabilities | 00012C41h | RO, R/WO |
| 88–89h | DMILCTL | DMI Link Control | 0000h | RO, R/W |
| 8A–8Bh | DMILSTS | DMI Link Status | 0001h | RO |



7.1 DMI VCECH—DMI Virtual Channel Enhanced Capability

B/D/F/Type: 0/0/0/DMIBAR
 Address Offset: 0-3h
 Default Value: 04010002h
 Access: RO
 Size: 32 bits

This register indicates DMI Virtual Channel capabilities.

| Bit | Access | Default Value | RST/PWR | Description |
|-------|--------|---------------|---------|--------------------------------------------------------------------------------------------------------------------------------------------------------------------------------------------------------------------------------------|
| 31:20 | RO | 040h | Core | Pointer to Next Capability (PNC): This field contains the offset to the next PCI Express capability structure in the linked list of capabilities (Link Declaration Capability). |
| 19:16 | RO | 1h | Core | PCI Express Virtual Channel Capability Version (PCIEVCCV): Hardwired to 1 to indicate compliances with the 1.1 version of the PCI Express specification. NOTE: This version does not change for 2.0 compliance. |
| 15:0 | RO | 0002h | Core | Extended Capability ID (ECID): Value of 0002h identifies this linked list item (capability structure) as being for PCI Express Virtual Channel registers. |

7.2 DMIPVCCAP1—DMI Port VC Capability Register 1

B/D/F/Type: 0/0/0/DMIBAR
 Address Offset: 4-7h
 Default Value: 00000001h
 Access: RO, R/WO
 Size: 32 bits

This register describes the configuration of PCI Express Virtual Channels associated with this port.

| Bit | Access | Default Value | RST/PWR | Description |
|------|--------|---------------|---------|-------------------------------------------------------------------------------------------------------------------------------------------------------------------------------------------------------------------------------------------------------------------------------------------------------------------------------------------------------------|
| 31:7 | RO | 0000000h | Core | Reserved |
| 6:4 | RO | 000b | Core | Low Priority Extended VC Count (LPEVCC): This field indicates the number of (extended) Virtual Channels in addition to the default VC belonging to the low-priority VC (LPVC) group that has the lowest priority with respect to other VC resources in a strict-priority VC Arbitration. The value of 0 in this field implies strict VC arbitration. |
| 3 | RO | 0b | Core | Reserved |
| 2:0 | R/WO | 001b | Core | Extended VC Count (EVCC): This field indicates the number of (extended) Virtual Channels in addition to the default VC supported by the device. The Private Virtual Channel is not included in this count. |



7.3 DMIPVCCAP2—DMI Port VC Capability Register 2

B/D/F/Type: 0/0/0/DMIBAR
 Address Offset: 8-Bh
 Default Value: 00000000h
 Access: RO
 Size: 32 bits

This register describes the configuration of PCI Express Virtual Channels associated with this port.

| Bit | Access | Default Value | RST/PWR | Description |
|-------|--------|---------------|---------|------------------------------------------------|
| 31:24 | RO | 00h | Core | Reserved for VC Arbitration Table Offset: |
| 23:8 | RO | 0000h | Core | Reserved |
| 7:0 | RO | 00h | Core | Reserved for VC Arbitration Capability (VCAC): |

7.4 DMIPVCCTL—DMI Port VC Control

B/D/F/Type: 0/0/0/DMIBAR
 Address Offset: C-Dh
 Default Value: 0000h
 Access: RO, R/W
 Size: 16 bits

| Bit | Access | Default Value | RST/PWR | Description |
|------|--------|---------------|---------|------------------------------------------------------------------------------------------------------------------------------------------------------------------------------------------------------------------------------------------------------------------------------------------------------------------------------------------------------------------------------------------------------------------------------------------------------------------------------------------------------------------------------------------------|
| 15:4 | RO | 000h | Core | Reserved |
| 3:1 | R/W | 000b | Core | <p>VC Arbitration Select (VCAS): This field will be programmed by software to the only possible value as indicated in the VC Arbitration Capability field.</p> <p>The value 000b when written to this field will indicate the VC arbitration scheme is hardware fixed (in the root complex). This field cannot be modified when more than one VC in the LPVC group is enabled.</p> <p>000 = Hardware fixed arbitration scheme (e.g, Round Robin)</p> <p>Others = Reserved</p> <p>See the PCI express specification for more details</p> |

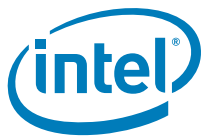

7.5 DMIVCORCAP—DMI VCO Resource Capability

B/D/F/Type: 0/0/0/DMIBAR
 Address Offset: 10-13h
 Default Value: 00000001h
 Access: RO
 Size: 32 bits

| Bit | Access | Default Value | RST/PWR | Description |
|-------|--------|---------------|---------|---------------------------------------------------------------------------------------------------------------------------------------------------------------------------------------------------------------------------------------------------------------------------------------------------------------------|
| 31:16 | RO | 0s | Core | Reserved |
| 15 | RO | 0b | Core | Reject Snoop Transactions (REJSNPT): 0 = Transactions with or without the No Snoop bit set within the TLP header are allowed on this VC. 1 = When Set, any transaction for which the No Snoop attribute is applicable but is not Set within the TLP Header will be rejected as an Unsupported Request. |
| 14:8 | RO | 00h | Core | Reserved |
| 7:0 | RO | 01h | Core | Port Arbitration Capability (PAC): Having only bit 0 set indicates that the only supported arbitration scheme for this VC is non-configurable hardware-fixed. |

7.6 DMIVCORCTLO—DMI VCO Resource Control

B/D/F/Type: 0/0/0/DMIBAR
 Address Offset: 14-17h
 Default Value: 800000FFh
 Access: RO, R/W
 Size: 32 bits

This register controls the resources associated with PCI Express Virtual Channel 0.

| Bit | Access | Default Value | RST/PWR | Description |
|-------|--------|---------------|---------|-------------------------------------------------------------------------------------------------------------------------------------------------------------------------------------------------------------------------------------------------------------------------------------------------------------------------------------------------------------------------|
| 31 | RO | 1b | Core | Virtual Channel 0 Enable (VCOE): For VCO, this bit is hardwired to 1 and read only as VCO can never be disabled. |
| 30:27 | RO | 0h | Core | Reserved |
| 26:24 | RO | 000b | Core | Virtual Channel 0 ID (VCOID): Assigns a VC ID to the VC resource. For VCO this is hardwired to 0 and read only. |
| 23:20 | RO | 0h | Core | Reserved |
| 19:17 | R/W | 000b | Core | Port Arbitration Select (PAS): This field configures the VC resource to provide a particular Port Arbitration service. Valid value for this field is a number corresponding to one of the asserted bits in the Port Arbitration Capability field of the VC resource. Because only bit 0 of that field is asserted. This field will always be programmed to 1. |



| Bit | Access | Default Value | RST/PWR | Description |
|------|--------|---------------|---------|---------------------------------------------------------------------------------------------------------------------------------------------------------------------------------------------------------------------------------------------------------------------------------------------------------------------------------------------------------------------------------------------------------------------------------------------------------------------------------------------------------------------------------------------------------------------------------------------|
| 16:8 | RO | 000h | Core | Reserved |
| 7:1 | R/W | 7Fh | Core | <p>Traffic Class / Virtual Channel 0 Map (TCVCOM): This field indicates the TCs (Traffic Classes) that are mapped to the VC resource. Bit locations within this field correspond to TC values.</p> <p>For example, when bit 7 is set in this field, TC7 is mapped to this VC resource. When more than one bit in this field is set, it indicates that multiple TCs are mapped to the VC resource. To remove one or more TCs from the TC/VC Map of an enabled VC, software must ensure that no new or outstanding transactions with the TC labels are targeted at the given Link.</p> |
| 0 | RO | 1b | Core | <p>Traffic Class 0 / Virtual Channel 0 Map (TC0VCOM): Traffic Class 0 is always routed to VC0.</p> |

7.7 DMI VCORSTS—DMI VCO Resource Status

B/D/F/Type: 0/0/0/DMIBAR
 Address Offset: 1A-1Bh
 Default Value: 0002h
 Access: RO
 Size: 16 bits

This register reports the Virtual Channel specific status.

| Bit | Access | Default Value | RST/PWR | Description |
|------|--------|---------------|---------|-----------------------------------------------------------------------------------------------------------------------------------------------------------------------------------------------------------------------------------------------------------------------------------------------------------------------------------------------------------------------------------------------------------------------------------------------------------------------------------------------------------------------------------------------------------------------------------------------------------------------------------------------------------------------------------------------------------------------|
| 15:2 | RO | 0000h | Core | <p>Reserved: Reserved and Zero for future R/WC/S implementations. Software must use 0 for writes to these bits.</p> |
| 1 | RO | 1b | Core | <p>Virtual Channel 0 Negotiation Pending (VCONP):</p> <p>0 = The VC negotiation is complete. 1 = The VC resource is still in the process of negotiation (initialization or disabling).</p> <p>This bit indicates the status of the process of Flow Control initialization. It is set by default on Reset, as well as whenever the corresponding Virtual Channel is Disabled or the Link is in the DL_Down state.</p> <p>It is cleared when the link successfully exits the FC_INIT2 state.</p> <p>BIOS Requirement: Before using a Virtual Channel, software must check whether the VC Negotiation Pending fields for that Virtual Channel are cleared in both Components on a Link.</p> |
| 0 | RO | 0b | Core | Reserved |



7.8 DMIVC1RCAP—DMI VC1 Resource Capability

B/D/F/Type: 0/0/0/DMIBAR
Address Offset: 1C-1Fh
Default Value: 00008001h
Access: RO
Size: 32 bits

| Bit | Access | Default Value | RST/PWR | Description |
|-------|--------|---------------|---------|---------------------------------------------------------------------------------------------------------------------------------------------------------------------------------------------------------------------------------------------------------------------------------------------------------------------|
| 31:16 | RO | 0s | Core | Reserved |
| 15 | RO | 1b | Core | Reject Snoop Transactions (REJSNPT): 0 = Transactions with or without the No Snoop bit set within the TLP header are allowed on this VC. 1 = When Set, any transaction for which the No Snoop attribute is applicable but is not Set within the TLP Header will be rejected as an Unsupported Request. |
| 14:8 | RO | 00h | Core | Reserved |
| 7:0 | RO | 01h | Core | Port Arbitration Capability (PAC): Having only bit 0 set indicates that the only supported arbitration scheme for this VC is non-configurable hardware-fixed. |

7.9 DMIVC1RCTL1—DMI VC1 Resource Control

B/D/F/Type: 0/0/0/DMIBAR
Address Offset: 20-23h
Default Value: 01000000h
Access: R/W, RO
Size: 32 bits

This register controls the resources associated with PCI Express Virtual Channel 1.



| Bit | Access | Default Value | RST/PWR | Description |
|-------|--------|---------------|---------|---------------------------------------------------------------------------------------------------------------------------------------------------------------------------------------------------------------------------------------------------------------------------------------------------------------------------------------------------------------------------------------------------------------------------------------------------------------------------------------------------------------------------------------------------------------------------------------------------------------------------------------------------------------------------------------------------------------------------------------------------------------------------------------------------------------------------------------------------------------------------------------------------------------------------------------------------------------------------------------------------------------------------------------------------------------------------------------------------------------------------------|
| 31 | R/W | 0b | Core | <p>Virtual Channel 1 Enable (VC1E): 0 = Virtual Channel is disabled. 1 = Virtual Channel is enabled. See exceptions below. Software must use the VC Negotiation Pending bit to check whether the VC negotiation is complete. When VC Negotiation Pending bit is cleared, a 1 read from this VC Enable bit indicates that the VC is enabled (Flow Control Initialization is completed for the PCI Express port). A 0 read from this bit indicates that the Virtual Channel is currently disabled.</p> <p>BIOS Requirement:</p> <ol style="list-style-type: none"> To enable a Virtual Channel, the VC Enable bits for that Virtual Channel must be set in both Components on a Link. To disable a Virtual Channel, the VC Enable bits for that Virtual Channel must be cleared in both Components on a Link. Software must ensure that no traffic is using a Virtual Channel at the time it is disabled. Software must fully disable a Virtual Channel in both Components on a Link before re-enabling the Virtual Channel. |
| 30:27 | RO | 0h | Core | Reserved |
| 26:24 | R/W | 001b | Core | Virtual Channel 1 ID (VC1ID): Assigns a VC ID to the VC resource. Assigned value must be non-zero. This field can not be modified when the VC is already enabled. |
| 23:20 | RO | 0h | Core | Reserved |
| 19:17 | R/W | 000b | Core | Port Arbitration Select (PAS): This field configures the VC resource to provide a particular Port Arbitration service. Valid value for this field is a number corresponding to one of the asserted bits in the Port Arbitration Capability field of the VC resource. |
| 16:8 | RO | 000h | Core | Reserved |
| 7:1 | R/W | 00h | Core | <p>Traffic Class / Virtual Channel 1 Map (TCVC1M): This field indicates the TCs (Traffic Classes) that are mapped to the VC resource. Bit locations within this field correspond to TC values.</p> <p>For example, when bit 7 is set in this field, TC7 is mapped to this VC resource. When more than one bit in this field is set, it indicates that multiple TCs are mapped to the VC resource. In order to remove one or more TCs from the TC/VC Map of an enabled VC, software must ensure that no new or outstanding transactions with the TC labels are targeted at the given Link.</p> |
| 0 | RO | 0b | Core | Traffic Class 0 / Virtual Channel 1 Map (TC0VC1M): Traffic Class 0 is always routed to VC0. |



7.10 DMIVC1RSTS—DMI VC1 Resource Status

B/D/F/Type: 0/0/0/DMIBAR
Address Offset: 26-27h
Default Value: 0002h
Access: RO
Size: 16 bits

This register reports the Virtual Channel specific status.

| Bit | Access | Default Value | RST/PWR | Description |
|------|--------|---------------|---------|---------------------------------------------------------------------------------------------------------------------------------------------------------------------------------------------------------------------------------------------------------------------------------------------------------------------------------------------------------------------------------------------------------------------------------------------------------------------------------------------------------------------------------------------------------------------------------------------------------------------------------------------------------------------------------------------------------------------|
| 15:2 | RO | 0000h | Core | Reserved |
| 1 | RO | 1b | Core | Virtual Channel 1 Negotiation Pending (VC1NP): 0 = The VC negotiation is complete. 1 = The VC resource is still in the process of negotiation (initialization or disabling). Software may use this bit when enabling or disabling the VC. This bit indicates the status of the process of Flow Control initialization. It is set by default on Reset, as well as whenever the corresponding Virtual Channel is Disabled or the Link is in the DL_Down state. It is cleared when the link successfully exits the FC_INIT2 state. Before using a Virtual Channel, software must check whether the VC Negotiation Pending fields for that Virtual Channel are cleared in both Components on a Link. |
| 0 | RO | 0b | Core | Reserved |



7.11 DMILCAP—DMI Link Capabilities

B/D/F/Type: 0/0/0/DMIBAR
 Address Offset: 84-87h
 Default Value: 00012C41h
 Access: RO, R/WO
 Size: 32 bits

This register indicates DMI specific capabilities.

| Bit | Access | Default Value | RST/PWR | Description |
|-------|--------|---------------|---------|-----------------------------------------------------------------------------------------------------------------------------------------------------------------------------------------------------------------------------------------------------------------------------------------------------------------------------------------------------------------------------------------------------------------------------------------------------------------------------------------------------------------------------------------------------------------------------------------------------------------------------------------------------------------------------------------------------------------------------------|
| 31:18 | RO | 0000h | Core | Reserved |
| 17:15 | R/WO | 010b | Core | <p>L1 Exit Latency (L1SELAT): This field indicates the length of time this Port requires to complete the transition from L1 to L0. The value 010 b indicates the range of 2 us to less than 4 us.</p> <p>000 = Less than 1µs 001 = 1 µs to less than 2 µs 010 = 2 µs to less than 4 µs 011 = 4 µs to less than 8 µs 100 = 8 µs to less than 16 µs 101 = 16 µs to less than 32 µs 110 = 32 µs–64 µs 111 = More than 64 µs</p> <p>Both bytes of this register that contain a portion of this field must be written simultaneously in order to prevent an intermediate (and undesired) value from ever existing.</p> |
| 14:12 | R/WO | 010b | Core | Reserved |
| 11:10 | RO | 11b | Core | Active State Link PM Support (ASLPMS): L1 entry supported. |
| 9:4 | RO | 04h | Core | Max Link Width (MLW): This field indicates the maximum number of lanes supported for this link. |
| 3:0 | RO | 1h | Core | Max Link Speed (MLS): Hardwired to indicate 2.5 Gb/s. |



7.12 DMILCTL—DMI Link Control

B/D/F/Type: 0/0/0/DMIBAR
 Address Offset: 88-89h
 Default Value: 0000h
 Access: RO, R/W
 Size: 16 bits

This register allows control of DMI.

| Bit | Access | Default Value | RST/PWR | Description |
|------|--------|---------------|---------|---------------------------------------------------------------------------------------------------------------------------------------------------------------------------------------------------------------------------------------------|
| 15:2 | RO | 00h | Core | Reserved |
| 7 | R/W | 0b | Core | Reserved |
| 6:2 | RO | 0h | Core | Reserved |
| 1:0 | R/W | 00b | Core | Active State Power Management Support (ASPMS): This register controls the level of active state power management supported on the given link. 00 = Disabled 01 = Reserved 10 = L1 Entry Enabled 11 = L1 Entry Enabled |

7.13 DMILSTS—DMI Link Status

B/D/F/Type: 0/0/0/DMIBAR
 Address Offset: 8A-8Bh
 Default Value: 0001h
 Access: RO
 Size: 16 bits

This register indicates DMI status.

| Bit | Access | Default Value | RST/PWR | Description |
|-------|--------|---------------|---------|------------------------------------------------------------------------------------------------------------------------------------------------------------------------------------------------------------------------------------------------------------------------------------------------------|
| 15:10 | RO | 00h | Core | Reserved |
| 9:4 | RO | 00h | Core | Negotiated Width (NWID): This register indicates negotiated link width. This field is valid only when the link is in the L0 or L1 states (after link width negotiation is successfully completed). 00h = Reserved 01h = X1 02h = X2 04h = X4 All other encodings are reserved. |
| 3:0 | RO | 1h | Core | Negotiated Speed (NSPD): This field indicates negotiated link speed. 1h = 2.5 Gb/s All other encodings are reserved. |





8 Host-Secondary PCI Express* Bridge Registers (D6:F0) (Intel® 82P45 MCH Only)

Device 6 contains the controls associated with the PCI Express root port that is the intended attach point for external devices. In addition, it also functions as the virtual PCI-to-PCI bridge. Table 14 provides an address map of the D1:F0 registers listed by address offset in ascending order. This chapter provides a detailed bit description of the registers.

Warning: When reading the PCI Express "conceptual" registers such as this, you may not get a valid value unless the register value is stable.

The *PCI Express* Specification* defines two types of reserved bits:

Reserved and Preserved:

- Reserved for future RW implementations; software must preserve value read for writes to bits.
- Reserved and Zero: Reserved for future R/WC/S implementations; software must use 0 for writes to bits.

Unless explicitly documented as Reserved and Zero, all bits marked as reserved are part of the Reserved and Preserved type, which have historically been the typical definition for Reserved.

Note: Most (if not all) control bits in this device cannot be modified unless the link is down. Software is required to first disable the link, then program the registers, and then re-enable the link (which will cause a full-retrain with the new settings).

Table 14. Host-Secondary PCI Express* Bridge Register Address Map (D6:F0) (Sheet 1 of 3)

| Address Offset | Register Symbol | Register Name | Default Value | Access |
|----------------|-----------------|-------------------------|--------------------------|---------|
| 0–1h | VID1 | Vendor Identification | 8086h | RO |
| 2–3h | DID1 | Device Identification | 29E9h | RO |
| 4–5h | PCICMD1 | PCI Command | 0000h | RO, RW |
| 6–7h | PCISTS1 | PCI Status | 0010h | RO, RWC |
| 8h | RID1 | Revision Identification | See register description | RO |
| 9–Bh | CC1 | Class Code | 060400h | RO |
| Ch | CL1 | Cache Line Size | 00h | RW |
| Eh | HDR1 | Header Type | 01h | RO |
| 18h | PBUSN1 | Primary Bus Number | 00h | RO |
| 19h | SBUSN1 | Secondary Bus Number | 00h | RW |
| 1Ah | SUBUSN1 | Subordinate Bus Number | 00h | RW |
| 1Ch | IOBASE1 | I/O Base Address | F0h | RO, RW |



Table 14. Host-Secondary PCI Express* Bridge Register Address Map (D6:F0) (Sheet 2 of 3)

| Address Offset | Register Symbol | Register Name | Default Value | Access |
|----------------|-----------------|-------------------------------------------|---------------|---------------|
| 1Dh | IOLIMIT1 | I/O Limit Address | 00h | RW, RO |
| 1E–1Fh | SSTS1 | Secondary Status | 0000h | RO, RWC |
| 20–21h | MBASE1 | Memory Base Address | FFF0h | RW, RO |
| 22–23h | MLIMIT1 | Memory Limit Address | 0000h | RW, RO |
| 24–25h | PMBASE1 | Prefetchable Memory Base Address | FFF1h | RW, RO |
| 26–27h | PMLIMIT1 | Prefetchable Memory Limit Address | 0001h | RO, RW |
| 28–2Bh | PMBASEU1 | Prefetchable Memory Base Address Upper | 00000000h | RW |
| 2C–2Fh | PMLIMITU1 | Prefetchable Memory Limit Address Upper | 00000000h | RW |
| 34h | CAPPTR1 | Capabilities Pointer | 88h | RO |
| 3Ch | INTRLINE1 | Interrupt Line | 00h | RW |
| 3Dh | INTRPIN1 | Interrupt Pin | 01h | RO |
| 3E–3Fh | BCTRL1 | Bridge Control | 0000h | RO, RW |
| 80–83h | PM_CAPID1 | Power Management Capabilities | C8039001h | RO |
| 84–87h | PM_CS1 | Power Management Control/Status | 00000008h | RO, RW, RW/P |
| 88–8Bh | SS_CAPID | Subsystem ID and Vendor ID Capabilities | 0000800Dh | RO |
| 8C–8Fh | SS | Subsystem ID and Subsystem Vendor ID | 00008086h | RWO |
| 90–91h | MSI_CAPID | Message Signaled Interrupts Capability ID | A005h | RO |
| 92–93h | MC | Message Control | 0000h | RW, RO |
| 94–97h | MA | Message Address | 00000000h | RO, RW |
| 98–99h | MD | Message Data | 0000h | RW |
| A0–A1h | PE_CAPL | PCI Express Capability List | 0010h | RO |
| A2–A3h | PE_CAP | PCI Express Capabilities | 0142h | RO, RWO |
| A4–A7h | DCAP | Device Capabilities | 00008000h | RO |
| A8–A9h | DCTL | Device Control | 0000h | RW, RO |
| AA–ABh | DSTS | Device Status | 0000h | RO, RWC |
| AC–AFh | LCAP | Link Capabilities | 03214D02h | RO, RWO |
| B0–B1h | LCTL | Link Control | 0000h | RO, RW, RW/SC |
| B2–hB3 | LSTS | Link Status | 1000h | RWC, RO |
| B4–B7h | SLOTCAP | Slot Capabilities | 00040000h | RWO, RO |
| B8–B9h | SLOTCTL | Slot Control | 0000h | RO, RW |
| BA–BBh | SLOTSTS | Slot Status | 0000h | RO, RWC |
| BC–BDh | RCTL | Root Control | 0000h | RO, RW |
| C0–C3h | RSTS | Root Status | 00000000h | RO, RWC |
| EC–EFh | PELC | PCI Express Legacy Control | 00000000h | RO, RW |

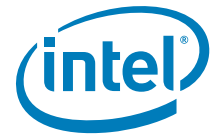

Table 14. Host-Secondary PCI Express* Bridge Register Address Map (D6:F0) (Sheet 3 of 3)

| Address Offset | Register Symbol | Register Name | Default Value | Access |
|----------------|-----------------|--------------------------------------------|----------------------|---------|
| 100–103h | VCECH | Virtual Channel Enhanced Capability Header | 14010002h | RO |
| 104–107h | PVCCAP1 | Port VC Capability Register 1 | 00000000h | RO |
| 108–10Bh | PVCCAP2 | Port VC Capability Register 2 | 00000000h | RO |
| 10C–10Dh | PVCCTL | Port VC Control | 0000h | RO, RW |
| 110–113h | VCORCAP | VCO Resource Capability | 00000000h | RO |
| 114–117h | VCORCTL | VCO Resource Control | 80000FFh | RO, RW |
| 11A–11Bh | VCORSTS | VCO Resource Status | 0002h | RO |
| 140–143h | RCLDECH | Root Complex Link Declaration Enhanced | 00010005h | RO |
| 144–147h | ESD | Element Self Description | 03000100h | RO, RWO |
| 150–153h | LE1D | Link Entry 1 Description | 00000000h | RO, RWO |
| 158–15Fh | LE1A | Link Entry 1 Address | 000000000 000000h | RO, RWO |

8.1 VID1—Vendor Identification

B/D/F/Type: 0/6/0/PCI
 Address Offset: 0–1h
 Default Value: 8086h
 Access: RO
 Size: 16 bits

This register combined with the Device Identification register uniquely identify any PCI device.

| Bit | Access | Default Value | RST/ PWR | Description |
|------|--------|---------------|-------------|-----------------------------------------------------------------------------|
| 15:0 | RO | 8086h | Core | Vendor Identification (VID1): PCI standard identification for Intel. |



8.2 DID1—Device Identification

B/D/F/Type: 0/6/0/PCI
Address Offset: 2–3h
Default Value: 29E9h
Access: RO
Size: 16 bits

This register combined with the Vendor Identification register uniquely identifies any PCI device.

| Bit | Access | Default Value | RST/ PWR | Description |
|------|--------|---------------|-------------|------------------------------------------------------------------------------------------------------------------------------------------|
| 15:8 | RO | 29h | Core | Device Identification Number (DID1(UB)) : Identifier assigned to the MCH device #6 (virtual PCI-to-PCI bridge, PCI Express port). |
| 7:4 | RO | Eh | Core | Device Identification Number (DID1(HW)) : Identifier assigned to the MCH device #6 (virtual PCI-to-PCI bridge, PCI Express port). |
| 3:0 | RO | 9h | Core | Device Identification Number (DID1(LB)) : Identifier assigned to the MCH device #6 (virtual PCI-to-PCI bridge, PCI Express port). |

8.3 PCICMD1—PCI Command

B/D/F/Type: 0/6/0/PCI
Address Offset: 4–5h
Default Value: 0000h
Access: RO, RW
Size: 16 bits

| Bit | Access | Default Value | RST/ PWR | Description |
|-------|--------|---------------|-------------|-----------------------------------------------------------------------------------------------------------------------------------------------------------------------------------------------------------------------------------------------------------------------------------------------------------------------------------------------------------------------------------------------------------------------------------------------------------------------------------------------------|
| 15:11 | RO | 00h | Core | Reserved |
| 10 | RW | 0b | Core | INTA Assertion Disable (INTAAD) : 0 = This device is permitted to generate INTA interrupt messages. 1 = This device is prevented from generating interrupt messages. Any INTA emulation interrupts already asserted must be de-asserted when this bit is set. This bit only affects interrupts generated by the device (PCI INTA from a PME event) controlled by this command register. It does not affect upstream MSIs, upstream PCI INTA-INTD assert and de-assert messages. |
| 9 | RO | 0b | Core | Fast Back-to-Back Enable (FB2B) : Not Applicable or Implemented. Hardwired to 0. |

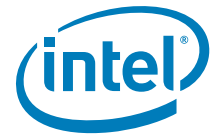

| Bit | Access | Default Value | RST/ PWR | Description |
|-----|--------|---------------|-------------|-----------------------------------------------------------------------------------------------------------------------------------------------------------------------------------------------------------------------------------------------------------------------------------------------------------------------------------------------------------------------------------------------------------------------------------------------------------------------------------------------------------------------------------------------------------------------------------------------------------------------------------------------------------------------------------------------------------------------------------------------------------------------------------------------------------------------------------------------------------------------------------------------------------------------------------------------------------------------------------------------------------------------------------------------------------------------------------------------------------------------------------------------------------------------|
| 8 | RW | 0b | Core | <p>SERR# Message Enable (SERRE1): This bit controls Device 6 SERR# messaging. The MCH communicates the SERR# condition by sending a SERR message to the ICH. This bit, when set, enables reporting of non-fatal and fatal errors detected by the device to the Root Complex. Note that errors are reported if enabled either through this bit or through the PCI-Express specific bits in the Device Control Register.</p> <p>0 = The SERR message is generated by the MCH for Device 6 only under conditions enabled individually through the Device Control Register.</p> <p>1 = The MCH is enabled to generate SERR messages which will be sent to the ICH for specific Device 6 error conditions generated/ detected on the primary side of the virtual PCI to PCI bridge (not those received by the secondary side). The status of SERRs generated is reported in the PCISTS1 register.</p> |
| 7 | RO | 0b | Core | Reserved |
| 6 | RW | 0b | Core | <p>Parity Error Response Enable (PERRE): Controls whether or not the Master Data Parity Error bit in the PCI Status register can be set.</p> <p>0 = Master Data Parity Error bit in PCI Status register can NOT be set.</p> <p>1 = Master Data Parity Error bit in PCI Status register CAN be set.</p> |
| 5:3 | RO | 0b | Core | Reserved |
| 2 | RW | 0b | Core | <p>Bus Master Enable (BME): Controls the ability of the PCI Express port to forward Memory and I/O Read/Write Requests in the upstream direction.</p> <p>0 = This device is prevented from making memory or IO requests to its primary bus. Note that according to PCI Specification, as MSI interrupt messages are in-band memory writes, disabling the bus master enable bit prevents this device from generating MSI interrupt messages or passing them from its secondary bus to its primary bus. Upstream memory writes/reads, IO writes/reads, peer writes/reads, and MSIs will all be treated as illegal cycles. Writes are forwarded to memory address C0000h with byte enables de-asserted. Reads will be forwarded to memory address C0000h and will return Unsupported Request status (or Master abort) in its completion packet.</p> <p>1 = This device is allowed to issue requests to its primary bus. Completions for previously issued memory read requests on the primary bus will be issued when the data is available.</p> <p>This bit does not affect forwarding of Completions from the primary interface to the secondary interface.</p> |
| 1 | RW | 0b | Core | <p>Memory Access Enable (MAE):</p> <p>0 = All of device #6's memory space is disabled.</p> <p>1 = Enable the Memory and Pre-fetchable memory address ranges defined in the MBASE1, MLIMIT1, PMBASE1, and PMLIMIT1 registers.</p> |
| 0 | RW | 0b | Core | <p>IO Access Enable (IOAE):</p> <p>0 = All of device #6's I/O space is disabled.</p> <p>1 = Enable the I/O address range defined in the IOBASE1, and IOLIMIT1 registers.</p> |



8.4 PCISTS1—PCI Status

B/D/F/Type: 0/6/0/PCI
 Address Offset: 6–7h
 Default Value: 0010h
 Access: RO, RWC
 Size: 16 bits

This register reports the occurrence of error conditions associated with primary side of the "virtual" Host-PCI Express bridge embedded within the MCH.

| Bit | Access | Default Value | RST/ PWR | Description |
|------|--------|---------------|-------------|-----------------------------------------------------------------------------------------------------------------------------------------------------------------------------------------------------------------------------------------------------------------------------------------------------------------------------------------------------------------------------------------------------------------------------------------------------------------------------------------------------------------------------------------------------------------------------------------------------------------------------------------------|
| 15 | RO | 0b | Core | Detected Parity Error (DPE): Not Applicable or Implemented. Hardwired to 0. Parity (generating poisoned Transaction Layer Packets) is not supported on the primary side of this device. |
| 14 | RWC | 0b | Core | Signaled System Error (SSE): This bit is set when this Device sends a SERR due to detecting an ERR_FATAL or ERR_NONFATAL condition and the SERR Enable bit in the Command register is 1. Both received (if enabled by BCTRL1[1]) and internally detected error messages do not affect this field). |
| 13 | RO | 0b | Core | Received Master Abort Status (RMAS): Not Applicable or Implemented. Hardwired to 0. The concept of a master abort does not exist on primary side of this device. |
| 12 | RO | 0b | Core | Received Target Abort Status (RTAS): Not Applicable or Implemented. Hardwired to 0. The concept of a target abort does not exist on primary side of this device. |
| 11 | RO | 0b | Core | Signaled Target Abort Status (STAS): Not Applicable or Implemented. Hardwired to 0. The concept of a target abort does not exist on primary side of this device. |
| 10:9 | RO | 00b | Core | DEVSELB Timing (DEVT): This device is not the subtractively decoded device on bus 0. This bit field is therefore hardwired to 00 to indicate that the device uses the fastest possible decode. |
| 8 | RO | 0b | Core | Master Data Parity Error (PMDPE): Because the primary side of the PCI Express's virtual peer-to-peer bridge is integrated with the MCH functionality, there is no scenario where this bit will get set. Because hardware will never set this bit, it is impossible for software to have an opportunity to clear this bit or otherwise test that it is implemented. The PCI specification defines it as a R/WC, but for our implementation an RO definition behaves the same way and will meet all Microsoft testing requirements. This bit can only be set when the Parity Error Enable bit in the PCI Command register is set. |
| 7 | RO | 0b | Core | Fast Back-to-Back (FB2B): Not Applicable or Implemented. Hardwired to 0. |
| 6 | RO | 0b | Core | Reserved |
| 5 | RO | 0b | Core | 66/60MHz capability (CAP66): Not Applicable or Implemented. Hardwired to 0. |
| 4 | RO | 1b | Core | Capabilities List (CAPL): Indicates that a capabilities list is present. Hardwired to 1. |



| Bit | Access | Default Value | RST/ PWR | Description |
|-----|--------|---------------|-------------|-----------------------------------------------------------------------------------------------------------------------------------------------------------------------------------------------------------------------------------------------------------------------------|
| 3 | RO | 0b | Core | INTA Status (INTAS) : Indicates that an interrupt message is pending internally to the device. Only PME sources feed into this status bit (not PCI INTA-INTD assert and de-assert messages). The INTA Assertion Disable bit, PCICMD1[10], has no effect on this bit. |
| 2:0 | RO | 000b | Core | Reserved |

8.5 RID1—Revision Identification

B/D/F/Type: 0/6/0/PCI
 Address Offset: 8h
 Default Value: see description below
 Access: RO
 Size: 8 bits

This register contains the revision number of the MCH device 6. These bits are read only and writes to this register have no effect.

| Bit | Access | Default Value | RST/ PWR | Description |
|-----|--------|-----------------|-------------|------------------------------------------------------------------------------------------------------------------------------------------------------------------------------------------------------------------------------------------------|
| 7:0 | RO | see description | Core | Revision Identification Number (RID1) : This is an 8-bit value that indicates the revision identification number for the MCH Device 0. Refer to the <i>Intel® 4 Series Chipset Specification Update</i> for the value of this register. |

8.6 CC1—Class Code

B/D/F/Type: 0/6/0/PCI
 Address Offset: 9–Bh
 Default Value: 060400h
 Access: RO
 Size: 24 bits

This register identifies the basic function of the device, a more specific sub-class, and a register-specific programming interface.

| Bit | Access | Default Value | RST/ PWR | Description |
|-------|--------|---------------|-------------|-----------------------------------------------------------------------------------------------------------------------------------------------------------------------------------------------------|
| 23:16 | RO | 06h | Core | Base Class Code (BCC) : Indicates the base class code for this device. This code has the value 06h, indicating a Bridge device. |
| 15:8 | RO | 04h | Core | Sub-Class Code (SUBCC) : Indicates the sub-class code for this device. The code is 04h indicating a PCI to PCI Bridge. |
| 7:0 | RO | 00h | Core | Programming Interface (PI) : Indicates the programming interface of this device. This value does not specify a particular register set layout and provides no practical use for this device. |



8.7 CL1—Cache Line Size

B/D/F/Type: 0/6/0/PCI
Address Offset: Ch
Default Value: 00h
Access: RW
Size: 8 bits

| Bit | Access | Default Value | RST/ PWR | Description |
|-----|--------|---------------|-------------|---------------------------------------------------------------------------------------------------------------------------------------------------------------------------------------------|
| 7:0 | RW | 00h | Core | Cache Line Size (Scratch pad): Implemented by PCI Express devices as a read-write field for legacy compatibility purposes but has no impact on any PCI Express device functionality. |

8.8 HDR1—Header Type

B/D/F/Type: 0/6/0/PCI
Address Offset: Eh
Default Value: 01h
Access: RO
Size: 8 bits

This register identifies the header layout of the configuration space. No physical register exists at this location.

| Bit | Access | Default Value | RST/ PWR | Description |
|-----|--------|---------------|-------------|-----------------------------------------------------------------------------------------------------------------------------|
| 7:0 | RO | 01h | Core | Header Type Register (HDR): Returns 01h to indicate that this is a single function device with bridge header layout. |

8.9 PBUSN1—Primary Bus Number

B/D/F/Type: 0/6/0/PCI
Address Offset: 18h
Default Value: 00h
Access: RO
Size: 8 bits

This register identifies that this "virtual" Host-PCI Express bridge is connected to PCI bus #0.

| Bit | Access | Default Value | RST/ PWR | Description |
|-----|--------|---------------|-------------|------------------------------------------------------------------------------------------------------------------------------------------------------------------------------------------------------------------------------------------------------------------------------|
| 7:0 | RO | 00h | Core | Primary Bus Number (BUSN): Configuration software typically programs this field with the number of the bus on the primary side of the bridge. Since device #6 is an internal device and its primary bus is always 0, these bits are read only and are hardwired to 0. |



8.10 SBUSN1—Secondary Bus Number

B/D/F/Type: 0/6/0/PCI
 Address Offset: 19h
 Default Value: 00h
 Access: RW
 Size: 8 bits

This register identifies the bus number assigned to the second bus side of the "virtual" bridge. This number is programmed by the PCI configuration software to allow mapping of configuration cycles to PCI Express.

| Bit | Access | Default Value | RST/ PWR | Description |
|-----|--------|---------------|-------------|-------------------------------------------------------------------------------------------------------------------------------------|
| 7:0 | RW | 00h | Core | Secondary Bus Number (BUSN): This field is programmed by configuration software with the bus number assigned to PCI Express. |

8.11 SUBUSN1—Subordinate Bus Number

B/D/F/Type: 0/6/0/PCI
 Address Offset: 1Ah
 Default Value: 00h
 Access: RW
 Size: 8 bits

This register identifies the subordinate bus (if any) that resides at the level below PCI Express. This number is programmed by the PCI configuration software to allow mapping of configuration cycles to PCI Express.

| Bit | Access | Default Value | RST/ PWR | Description |
|-----|--------|---------------|-------------|-----------------------------------------------------------------------------------------------------------------------------------------------------------------------------------------------------------------------------------------------------------------------------------------------------------------------|
| 7:0 | RW | 00h | Core | Subordinate Bus Number (BUSN): This register is programmed by configuration software with the number of the highest subordinate bus that lies behind the device #6 bridge. When only a single PCI device resides on the PCI Express segment, this register will contain the same value as the SBUSN1 register. |



8.12 IOBASE1—I/O Base Address

B/D/F/Type: 0/6/0/PCI
Address Offset: 1Ch
Default Value: F0h
Access: RO, RW
Size: 8 bits

This register controls the processor to PCI Express I/O access routing based on the following formula:

$$\text{IO_BASE} \leq \text{address} \leq \text{IO_LIMIT}$$

Only upper 4 bits are programmable. For the purpose of address decode address bits A[11:0] are treated as 0. Thus the bottom of the defined I/O address range will be aligned to a 4 KB boundary.

| Bit | Access | Default Value | RST/PWR | Description |
|-----|--------|---------------|---------|------------------------------------------------------------------------------------------------------------------------------|
| 7:4 | RW | Fh | Core | I/O Address Base (IOBASE): This field corresponds to A[15:12] of the I/O addresses passed by bridge 1 to PCI Express. |
| 3:0 | RO | 0h | Core | Reserved |

8.13 IOLIMIT1—I/O Limit Address

B/D/F/Type: 0/6/0/PCI
Address Offset: 1Dh
Default Value: 00h
Access: RW, RO
Size: 8 bits

This register controls the processor to PCI Express I/O access routing based on the following formula:

$$\text{IO_BASE} \leq \text{address} \leq \text{IO_LIMIT}$$

Only upper 4 bits are programmable. For the purpose of address decode address bits A[11:0] are assumed to be FFFh. Thus, the top of the defined I/O address range will be at the top of a 4 KB aligned address block.

| Bit | Access | Default Value | RST/PWR | Description |
|-----|--------|---------------|---------|--------------------------------------------------------------------------------------------------------------------------------------------------------------------------------------------------------------------------|
| 7:4 | RW | 0h | Core | I/O Address Limit (IOLIMIT): Corresponds to A[15:12] of the I/O address limit of device #6. Devices between this upper limit and IOBASE1 will be passed to the PCI Express hierarchy associated with this device. |
| 3:0 | RO | 0h | Core | Reserved |



8.14 SSTS1—Secondary Status

B/D/F/Type: 0/6/0/PCI
 Address Offset: 1E–1Fh
 Default Value: 0000h
 Access: RO, RWC
 Size: 16 bits

SSTS1 is a 16-bit status register that reports the occurrence of error conditions associated with secondary side of the "virtual" PCI-PCI bridge embedded within MCH.

| Bit | Access | Default Value | RST/ PWR | Description |
|------|--------|---------------|-------------|------------------------------------------------------------------------------------------------------------------------------------------------------------------------------------------------------------------------------------------------------------------------------------|
| 15 | RWC | 0b | Core | Detected Parity Error (DPE): This bit is set by the Secondary Side for a Type 1 Configuration Space header device whenever it receives a Poisoned Transaction Layer Packet, regardless of the state of the Parity Error Response Enable bit in the Bridge Control Register. |
| 14 | RWC | 0b | Core | Received System Error (RSE): This bit is set when the Secondary Side for a Type 1 configuration space header device receives an ERR_FATAL or ERR_NONFATAL. |
| 13 | RWC | 0b | Core | Received Master Abort (RMA): This bit is set when the Secondary Side for Type 1 Configuration Space Header Device (for requests initiated by the Type 1 Header Device itself) receives a Completion with Unsupported Request Completion Status. |
| 12 | RWC | 0b | Core | Received Target Abort (RTA): This bit is set when the Secondary Side for Type 1 Configuration Space Header Device (for requests initiated by the Type 1 Header Device itself) receives a Completion with Completer Abort Completion Status. |
| 11 | RO | 0b | Core | Signaled Target Abort (STA): Not Applicable or Implemented. Hardwired to 0. The MCH does not generate Target Aborts (the MCH will never complete a request using the Completer Abort Completion status). |
| 10:9 | RO | 00b | Core | DEVSELB Timing (DEVT): Not Applicable or Implemented. Hardwired to 0. |
| 8 | RWC | 0b | Core | Master Data Parity Error (SMDPE): When set, indicates that the MCH received across the link (upstream) a Read Data Completion Poisoned Transaction Layer Packet (EP=1). This bit can only be set when the Parity Error Enable bit in the Bridge Control register is set. |
| 7 | RO | 0b | Core | Fast Back-to-Back (FB2B): Not Applicable or Implemented. Hardwired to 0. |
| 6 | RO | 0b | Core | Reserved |
| 5 | RO | 0b | Core | 66/60 MHz capability (CAP66): Not Applicable or Implemented. Hardwired to 0. |
| 4:0 | RO | 00h | Core | Reserved |



8.15 MBASE1—Memory Base Address

B/D/F/Type: 0/6/0/PCI
Address Offset: 20–21h
Default Value: FFF0h
Access: RW, RO
Size: 16 bits

This register controls the processor to PCI Express non-prefetchable memory access routing based on the following formula:

$$\text{MEMORY_BASE} \leq \text{address} \leq \text{MEMORY_LIMIT}$$

The upper 12 bits of the register are read/write and correspond to the upper 12 address bits A[31:20] of the 32 bit address. The bottom 4 bits of this register are read-only and return zeroes when read. This register must be initialized by the configuration software. For the purpose of address decode address bits A[19:0] are assumed to be 0. Thus, the bottom of the defined memory address range will be aligned to a 1 MB boundary.

| Bit | Access | Default Value | RST/ PWR | Description |
|------|--------|---------------|-------------|----------------------------------------------------------------------------------------------------------------------------------------|
| 15:4 | RW | FFFh | Core | Memory Address Base (MBASE): Corresponds to A[31:20] of the lower limit of the memory range that will be passed to PCI Express. |
| 3:0 | RO | 0h | Core | Reserved |



8.16 MLIMIT1—Memory Limit Address

B/D/F/Type: 0/6/0/PCI
 Address Offset: 22–23h
 Default Value: 0000h
 Access: RW, RO
 Size: 16 bits

This register controls the processor to PCI Express non-prefetchable memory access routing based on the following formula:

$$\text{MEMORY_BASE} \leq \text{address} \leq \text{MEMORY_LIMIT}$$

The upper 12 bits of the register are read/write and correspond to the upper 12 address bits A[31:20] of the 32 bit address. The bottom 4 bits of this register are read-only and return zeroes when read. This register must be initialized by the configuration software. For the purpose of address decode, address bits A[19:0] are assumed to be FFFFh. Thus, the top of the defined memory address range will be at the top of a 1 MB aligned memory block.

Note: Memory range covered by MBASE and MLIMIT registers are used to map non-prefetchable PCI Express address ranges (typically where control/status memory-mapped I/O data structures of the controller will reside) and PMBASE and PMLIMIT are used to map prefetchable address ranges (typically device local memory). This segregation allows application of USWC space attribute to be performed in a true plug-and-play manner to the prefetchable address range for improved processor- PCI Express memory access performance.

Note: Configuration software is responsible for programming all address range registers (prefetchable, non-prefetchable) with the values that provide exclusive address ranges (i.e., prevent overlap with each other and/or with the ranges covered with the main memory). There is no provision in the MCH hardware to enforce prevention of overlap and operations of the system in the case of overlap are not ensured.

| Bit | Access | Default Value | RST/ PWR | Description |
|------|--------|---------------|-------------|------------------------------------------------------------------------------------------------------------------------------|
| 15:4 | RW | 000h | Core | Memory Address Limit (MLIMIT): Corresponds to A[31:20] of the upper limit of the address range passed to PCI Express. |
| 3:0 | RO | 0h | Core | Reserved |

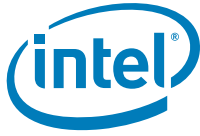

8.17 PMBASE1—Prefetchable Memory Base Address Upper

B/D/F/Type: 0/6/0/PCI
Address Offset: 24–25h
Default Value: FFF1h
Access: RW, RO
Size: 16 bits

This register in conjunction with the corresponding Upper Base Address register controls the processor to PCI Express prefetchable memory access routing based on the following formula:

$$\text{PREFETCHABLE_MEMORY_BASE} \leq \text{address} \leq \text{PREFETCHABLE_MEMORY_LIMIT}$$

The upper 12 bits of this register are read/write and correspond to address bits A[31:20] of the 40-bit address. The lower 8 bits of the Upper Base Address register are read/write and correspond to address bits A[39:32] of the 40-bit address. This register must be initialized by the configuration software. For the purpose of address decode, address bits A[19:0] are assumed to be 0. Thus, the bottom of the defined memory address range will be aligned to a 1 MB boundary.

| Bit | Access | Default Value | RST/ PWR | Description |
|------|--------|---------------|-------------|---------------------------------------------------------------------------------------------------------------------------------------------------------------------------------------------|
| 15:4 | RW | FFFh | Core | Prefetchable Memory Base Address (MBASE): Corresponds to A[31:20] of the lower limit of the memory range that will be passed to PCI Express. |
| 3:0 | RO | 1h | Core | 64-bit Address Support: Indicates that the upper 32 bits of the prefetchable memory region base address are contained in the Prefetchable Memory base Upper Address register at 28h. |

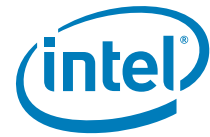

8.18 PMLIMIT1—Prefetchable Memory Limit Address

B/D/F/Type: 0/6/0/PCI
 Address Offset: 26–27h
 Default Value: 0001h
 Access: RO, RW
 Size: 16 bits

This register in conjunction with the corresponding Upper Limit Address register controls the processor to PCI Express prefetchable memory access routing based on the following formula:

$$\text{PREFETCHABLE_MEMORY_BASE} \leq \text{address} \leq \text{PREFETCHABLE_MEMORY_LIMIT}$$

The upper 12 bits of this register are read/write and correspond to address bits A[31:20] of the 40-bit address. The lower 8 bits of the Upper Limit Address register are read/write and correspond to address bits A[39:32] of the 40-bit address. This register must be initialized by the configuration software. For the purpose of address decode, address bits A[19:0] are assumed to be FFFFh. Thus, the top of the defined memory address range will be at the top of a 1 MB aligned memory block. Note that prefetchable memory range is supported to allow segregation by the configuration software between the memory ranges that must be defined as UC and the ones that can be designated as a USWC (i.e., prefetchable) from the processor perspective.

| Bit | Access | Default Value | RST/ PWR | Description |
|------|--------|---------------|-------------|--------------------------------------------------------------------------------------------------------------------------------------------------------------------------------------------------------|
| 15:4 | RW | 000h | Core | Prefetchable Memory Address Limit (PMLIMIT): This field corresponds to A[31:20] of the upper limit of the address range passed to PCI Express. |
| 3:0 | RO | 1h | Core | 64-bit Address Support: This field indicates that the upper 32 bits of the prefetchable memory region limit address are contained in the Prefetchable Memory Base Limit Address register at 2Ch |



8.19 PMBASEU1—Prefetchable Memory Base Address Upper

B/D/F/Type: 0/6/0/PCI
Address Offset: 28–2Bh
Default Value: 00000000h
Access: RW
Size: 32 bits

The functionality associated with this register is present in the PCI Express design implementation.

This register in conjunction with the corresponding Upper Base Address register controls the processor to PCI Express prefetchable memory access routing based on the following formula:

$$\text{PREFETCHABLE_MEMORY_BASE} \leq \text{address} \leq \text{PREFETCHABLE_MEMORY_LIMIT}$$

The upper 12 bits of this register are read/write and correspond to address bits A[31:20] of the 40-bit address. The lower 8 bits of the Upper Base Address register are read/write and correspond to address bits A[39:32] of the 40-bit address. This register must be initialized by the configuration software. For the purpose of address decode, address bits A[19:0] are assumed to be 0. Thus, the bottom of the defined memory address range will be aligned to a 1 MB boundary.

| Bit | Access | Default Value | RST/ PWR | Description |
|------|--------|---------------|-------------|------------------------------------------------------------------------------------------------------------------------------------------------------------------------------|
| 31:0 | RW | 00000000h | Core | Prefetchable Memory Base Address (MBASEU): This field corresponds to A[63:32] of the lower limit of the prefetchable memory range that will be passed to PCI Express. |

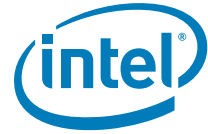

8.20 PMLIMITU1—Prefetchable Memory Limit Address Upper

B/D/F/Type: 0/6/0/PCI
 Address Offset: 2C–2Fh
 Default Value: 00000000h
 Access: RW
 Size: 32 bits

The functionality associated with this register is present in the PCI Express design implementation.

This register in conjunction with the corresponding Upper Limit Address register controls the processor to PCI Express prefetchable memory access routing based on the following formula:

$$\text{PREFETCHABLE_MEMORY_BASE} \leq \text{address} \leq \text{PREFETCHABLE_MEMORY_LIMIT}$$

The upper 12 bits of this register are read/write and correspond to address bits A[31:20] of the 40-bit address. The lower 8 bits of the Upper Limit Address register are read/write and correspond to address bits A[39:32] of the 40-bit address. This register must be initialized by the configuration software. For the purpose of address decode, address bits A[19:0] are assumed to be FFFFh. Thus, the top of the defined memory address range will be at the top of a 1MB aligned memory block.

Note that prefetchable memory range is supported to allow segregation by the configuration software between the memory ranges that must be defined as UC and the ones that can be designated as a USWC (i.e., prefetchable) from the processor perspective.

| Bit | Access | Default Value | RST/ PWR | Description |
|------|--------|---------------|-------------|--------------------------------------------------------------------------------------------------------------------------------------------------------------------------------|
| 31:0 | RW | 00000000h | Core | Prefetchable Memory Address Limit (MLIMITU): This field corresponds to A[63:32] of the upper limit of the prefetchable Memory range that will be passed to PCI Express. |



8.21 CAPPTR1—Capabilities Pointer

B/D/F/Type: 0/6/0/PCI
Address Offset: 34h
Default Value: 88h
Access: RO
Size: 8 bits

The capabilities pointer provides the address offset to the location of the first entry in this device's linked list of capabilities.

| Bit | Access | Default Value | RST/ PWR | Description |
|-----|--------|---------------|-------------|-----------------------------------------------------------------------------------------------------------------------------|
| 7:0 | RO | 88h | Core | First Capability (CAPPTR1): The first capability in the list is the Subsystem ID and Subsystem Vendor ID Capability. |

8.22 INTRLINE1—Interrupt Line

B/D/F/Type: 0/6/0/PCI
Address Offset: 3Ch
Default Value: 00h
Access: RW
Size: 8 bits

This register contains interrupt line routing information. The device itself does not use this value, rather it is used by device drivers and operating systems to determine priority and vector information.

| Bit | Access | Default Value | RST/ PWR | Description |
|-----|--------|---------------|-------------|-----------------------------------------------------------------------------------------------|
| 7:0 | RW | 00h | Core | Interrupt Connection (INTCON): Used to communicate interrupt line routing information. |

8.23 INTRPIN1—Interrupt Pin

B/D/F/Type: 0/6/0/PCI
Address Offset: 3Dh
Default Value: 01h
Access: RO
Size: 8 bits

This register specifies which interrupt pin this device uses.

| Bit | Access | Default Value | RST/ PWR | Description |
|-----|--------|---------------|-------------|------------------------------------------------------------------------------------------------------------------------------------|
| 7:0 | RO | 01h | Core | Interrupt Pin (INTRPIN): As a single function device, the PCI Express device specifies INTA as its interrupt pin. 01h=INTA. |



8.24 BCTRL1—Bridge Control

B/D/F/Type: 0/6/0/PCI
 Address Offset: 3E–3Fh
 Default Value: 0000h
 Access: RO, RW
 Size: 16 bits

This register provides extensions to the PCICMD1 register that are specific to PCI-PCI bridges. The BCTRL provides additional control for the secondary interface as well as some bits that affect the overall behavior of the "virtual" Host-PCI Express bridge embedded in the MCH.

| Bit | Access | Default Value | RST/PWR | Description |
|-------|--------|---------------|---------|----------------------------------------------------------------------------------------------------------------------------------------------------------------------------------------------------------------------------------------------------------------------------------------------------------------------------------------------------------------------------------------------------------------------------------------------------------------------------------------------------------------------------------------------------------------------------------------------------------------------------------------------------|
| 15:12 | RO | 0h | Core | Reserved |
| 11 | RO | 0b | Core | Discard Timer SERR# Enable (DTSERRE) : Not Applicable or Implemented. Hardwired to 0. |
| 10 | RO | 0b | Core | Discard Timer Status (DTSTS) : Not Applicable or Implemented. Hardwired to 0. |
| 9 | RO | 0b | Core | Secondary Discard Timer (SDT) : Not Applicable or Implemented. Hardwired to 0. |
| 8 | RO | 0b | Core | Primary Discard Timer (PDT) : Not Applicable or Implemented. Hardwired to 0. |
| 7 | RO | 0b | Core | Fast Back-to-Back Enable (FB2BEN) : Not Applicable or Implemented. Hardwired to 0. |
| 6 | RW | 0b | Core | Secondary Bus Reset (SRESET) : Setting this bit triggers a hot reset on the corresponding PCI Express Port. This will force the LTSSM to transition to the Hot Reset state (via Recovery) from L0 or L1 states. |
| 5 | RO | 0b | Core | Master Abort Mode (MAMODE) : Does not apply to PCI Express. Hardwired to 0. |
| 4 | RW | 0b | Core | VGA 16-bit Decode (VGA16D) : Enables the PCI-to-PCI bridge to provide 16-bit decoding of VGA I/O address precluding the decoding of alias addresses every 1 KB. This bit only has meaning if bit 3 (VGA Enable) of this register is also set to 1, enabling VGA I/O decoding and forwarding by the bridge. 0 = Execute 10-bit address decodes on VGA I/O accesses. 1 = Execute 16-bit address decodes on VGA I/O accesses. |
| 3 | RW | 0b | Core | VGA Enable (VGAEN) : Controls the routing of processor initiated transactions targeting VGA compatible I/O and memory address ranges. See the VGAEN/MDAP table in device 0, offset 97h[0]. |
| 2 | RW | 0b | Core | ISA Enable (ISAEN) : Needed to exclude legacy resource decode to route ISA resources to legacy decode path. Modifies the response by the MCH to an I/O access issued by the processor that target ISA I/O addresses. This applies only to I/O addresses that are enabled by the IOBASE and IOLIMIT registers. 0 = All addresses defined by the IOBASE and IOLIMIT for processor I/O transactions will be mapped to PCI Express. 1 = MCH will not forward to PCI Express any I/O transactions addressing the last 768 bytes in each 1 KB block even if the addresses are within the range defined by the IOBASE and IOLIMIT registers. |



| Bit | Access | Default Value | RST/ PWR | Description |
|-----|--------|---------------|-------------|------------------------------------------------------------------------------------------------------------------------------------------------------------------------------------------------------------------------------------------------------------------------------------------------------------------------------------------------------------------------------------------------------------------------|
| 1 | RW | 0b | Core | SERR Enable (SERREN): 0 = No forwarding of error messages from secondary side to primary side that could result in an SERR. 1 = ERR_COR, ERR_NONFATAL, and ERR_FATAL messages result in SERR message when individually enabled by the Root Control register. |
| 0 | RW | 0b | Core | Parity Error Response Enable (PEREN): Controls whether or not the Master Data Parity Error bit in the Secondary Status register is set when the MCH receives across the link (upstream) a Read Data Completion Poisoned Transaction Layer Packet. 0 = Master Data Parity Error bit in Secondary Status register can NOT be set. 1 = Master Data Parity Error bit in Secondary Status register CAN be set. |

8.25 PM_CAPID1—Power Management Capabilities

B/D/F/Type: 0/6/0/PCI
 Address Offset: 80–83h
 Default Value: C8039001h
 Access: RO
 Size: 32 bits

| Bit | Access | Default Value | RST/ PWR | Description |
|-------|--------|---------------|-------------|------------------------------------------------------------------------------------------------------------------------------------------------------------------------------------------------------------------------------------------------------------------------------------------------------------------------------------------------------------------------------------------------------------|
| 31:27 | RO | 19h | Core | PME Support (PMES): This field indicates the power states in which this device may indicate PME wake via PCI Express messaging. D0, D3hot & D3cold. This device is not required to do anything to support D3hot and D3cold, it simply must report that those states are supported. Refer to the PCI Power Management 1.1 specification for encoding explanation and other power management details. |
| 26 | RO | 0b | Core | D2 Power State Support (D2PSS): Hardwired to 0 to indicate that the D2 power management state is NOT supported. |
| 25 | RO | 0b | Core | D1 Power State Support (D1PSS): Hardwired to 0 to indicate that the D1 power management state is NOT supported. |
| 24:22 | RO | 000b | Core | Auxiliary Current (AUXC): Hardwired to 0 to indicate that there are no 3.3Vaux auxiliary current requirements. |
| 21 | RO | 0b | Core | Device Specific Initialization (DSI): Hardwired to 0 to indicate that special initialization of this device is NOT required before generic class device driver is to use it. |
| 20 | RO | 0b | Core | Auxiliary Power Source (APS): Hardwired to 0. |
| 19 | RO | 0b | Core | PME Clock (PMECLK): Hardwired to 0 to indicate this device does NOT support PMEB generation. |
| 18:16 | RO | 011b | Core | PCI PM CAP Version (PCIPMCV): A value of 011b indicates that this function complies with <i>PCI Power Management Interface Specification, Revision 1.2</i> . |
| 15:8 | RO | 90h | Core | Pointer to Next Capability (PNC): This contains a pointer to the next item in the capabilities list. If MSICH (CAPL[0] @ 7Fh) is 0, then the next item in the capabilities list is the Message Signaled Interrupts (MSI) capability at 90h. |
| 7:0 | RO | 01h | Core | Capability ID (CID): Value of 01h identifies this linked list item (capability structure) as being for PCI Power Management registers. |

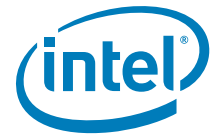

8.26 PM_CS1—Power Management Control/Status

B/D/F/Type: 0/6/0/PCI
 Address Offset: 84–87h
 Default Value: 00000008h
 Access: RO, RW, RW/P
 Size: 32 bits

| Bit | Access | Default Value | RST/PWR | Description |
|-------|--------|---------------|---------|-----------------------------------------------------------------------------------------------------------------------------------------------------------------------------------------------------------------------------------------------------------------------------------------------------------------------------------------------------------------------------------------------------------------------------------------------------------------------------------------------------------------------------------------------------------------------------------------------------------------------------------------------------------------------------------------------------------------------------------------------------------------------------------------------------------------------------------------------------------------------------------------------------------------------------------------------------------------------------------------------------------------------------------------------------------------------------------------------------------------------------------------------------------------------------------------------------------------|
| 31:16 | RO | 0000h | Core | Reserved |
| 15 | RO | 0b | Core | PME Status (PMESTS): This bit indicates that this device does not support PMEB generation from D3cold. |
| 14:13 | RO | 00b | Core | Data Scale (DSCALE): This field indicates that this device does not support the power management data register. |
| 12:9 | RO | 0h | Core | Data Select (DSEL): This field indicates that this device does not support the power management data register. |
| 8 | RW/P | 0b | Core | PME Enable (PMEE): This bit indicates that this device does not generate PMEB assertion from any D-state. 0 = PMEB generation not possible from any D State 1 = PMEB generation enabled from any D State The setting of this bit has no effect on hardware. See PM_CAP[15:11] |
| 7:2 | RO | 0000b | Core | Reserved |
| 1:0 | RW | 00b | Core | Power State (PS): This field indicates the current power state of this device and can be used to set the device into a new power state. If software attempts to write an unsupported state to this field, write operation must complete normally on the bus, but the data is discarded and no state change occurs. 00 = D0 01 = D1 (Not supported in this device.) 10 = D2 (Not supported in this device.) 11 = D3 Support of D3cold does not require any special action. While in the D3hot state, this device can only act as the target of PCI configuration transactions (for power management control). This device also cannot generate interrupts or respond to MMR cycles in the D3 state. The device must return to the D0 state in order to be fully-functional. When the Power State is other than D0, the bridge will Master Abort (i.e. not claim) any downstream cycles (with exception of type 0 config cycles). Consequently, these unclaimed cycles will go down DMI and come back up as Unsupported Requests, which the MCH logs as Master Aborts in Device 0 PCISTS[13] There is no additional hardware functionality required to support these Power States. |



8.27 SS_CAPID—Subsystem ID and Vendor ID Capabilities

B/D/F/Type: 0/6/0/PCI
Address Offset: 88–8Bh
Default Value: 0000800Dh
Access: RO
Size: 32 bits

This capability is used to uniquely identify the subsystem where the PCI device resides. Because this device is an integrated part of the system and not an add-in device, it is anticipated that this capability will never be used. However, it is necessary because Microsoft will test for its presence.

| Bit | Access | Default Value | RST/ PWR | Description |
|-------|--------|---------------|-------------|----------------------------------------------------------------------------------------------------------------------------------------------------------------|
| 31:16 | RO | 0000h | Core | Reserved |
| 15:8 | RO | 80h | Core | Pointer to Next Capability (PNC): This field contains a pointer to the next item in the capabilities list which is the PCI Power Management capability. |
| 7:0 | RO | 0Dh | Core | Capability ID (CID): Value of 0Dh identifies this linked list item (capability structure) as being for SSID/SSVID registers in a PCI-to-PCI Bridge. |

8.28 SS—Subsystem ID and Subsystem Vendor ID

B/D/F/Type: 0/6/0/PCI
Address Offset: 8C–8Fh
Default Value: 00008086h
Access: RWO
Size: 32 bits

System BIOS can be used as the mechanism for loading the SSID/SVID values. These values must be preserved through power management transitions and a hardware reset.

| Bit | Access | Default Value | RST/ PWR | Description |
|-------|--------|---------------|-------------|----------------------------------------------------------------------------------------------------------------------------------------------------------------------------------|
| 31:16 | RWO | 0000h | Core | Subsystem ID (SSID): This bit identifies the particular subsystem and is assigned by the vendor. |
| 15:0 | RWO | 8086h | Core | Subsystem Vendor ID (SVID): This field identifies the manufacturer of the subsystem and is the same as the vendor ID which is assigned by the PCI Special Interest Group. |



8.29 MSI_CAPID—Message Signaled Interrupts Capability ID

B/D/F/Type: 0/6/0/PCI
 Address Offset: 90–91h
 Default Value: A005h
 Access: RO
 Size: 16 bits

When a device supports MSI, it can generate an interrupt request to the processor by writing a predefined data item (a message) to a predefined memory address.

| Bit | Access | Default Value | RST/ PWR | Description |
|------|--------|---------------|-------------|-------------------------------------------------------------------------------------------------------------------------------------------------------|
| 15:8 | RO | A0h | Core | Pointer to Next Capability (PNC): This field contains a pointer to the next item in the capabilities list which is the PCI Express capability. |
| 7:0 | RO | 05h | Core | Capability ID (CID): Value of 05h identifies this linked list item (capability structure) as being for MSI registers. |

8.30 MC—Message Control

B/D/F/Type: 0/6/0/PCI
 Address Offset: 92–93h
 Default Value: 0000h
 Access: RW, RO
 Size: 16 bits

System software can modify bits in this register, but the device is prohibited from doing so.

If the device writes the same message multiple times, only one of those messages is guaranteed to be serviced. If all of them must be serviced, the device must not generate the same message again until the driver services the earlier one.

| Bit | Access | Default Value | RST/ PWR | Description |
|------|--------|---------------|-------------|--------------------------------------------------------------------------------------------------------------------------------------------------------------------------------------------------------------------------------------------------------------------------------|
| 15:8 | RO | 00h | Core | Reserved |
| 7 | RO | 0b | Core | 64-bit Address Capable (64AC): Hardwired to 0 to indicate that the function does not implement the upper 32 bits of the Message Address register and is incapable of generating a 64-bit memory address. |
| 6:4 | RW | 000b | Core | Multiple Message Enable (MME): System software programs this field to indicate the actual number of messages allocated to this device. This number will be equal to or less than the number actually requested. The encoding is the same as for the MMC field below. |
| 3:1 | RO | 000b | Core | Multiple Message Capable (MMC): System software reads this field to determine the number of messages being requested by this device. The value of 000b equates to 1 message requested. 000 = 1 message requested All other encodings are reserved. |
| 0 | RW | 0b | Core | MSI Enable (MSIEN): Controls the ability of this device to generate MSIs. 0 = MSI will not be generated. 1 = MSI will be generated when we receive PME messages. INTA will not be generated and INTA Status (PCISTS1[3]) will not be set. |



8.31 MA—Message Address

B/D/F/Type: 0/6/0/PCI
Address Offset: 94–97h
Default Value: 00000000h
Access: RO, RW
Size: 32 bits

| Bit | Access | Default Value | RST/ PWR | Description |
|------|--------|---------------|-------------|--------------------------------------------------------------------------------------------------------------------------------------------------------------------------------------------|
| 31:2 | RW | 00000000h | Core | Message Address (MA) : Used by system software to assign an MSI address to the device. The device handles an MSI by writing the padded contents of the MD register to this address. |
| 1:0 | RO | 00b | Core | Force DWord Align (FDWA) : Hardwired to 0 so that addresses assigned by system software are always aligned on a DWord address boundary. |

8.32 MD—Message Data

B/D/F/Type: 0/6/0/PCI
Address Offset: 98–99h
Default Value: 0000h
Access: RW
Size: 16 bits

| Bit | Access | Default Value | RST/ PWR | Description |
|------|--------|---------------|-------------|------------------------------------------------------------------------------------------------------------------------------------------------------------------------------------------------------------------------------------------------------------------------------------------------------------------------------------------------------|
| 15:0 | RW | 0000h | Core | Message Data (MD) : Base message data pattern assigned by system software and used to handle an MSI from the device. When the device must generate an interrupt request, it writes a 32-bit value to the memory address specified in the MA register. The upper 16-bits are always set to 0. The lower 16-bits are supplied by this register. |

8.33 PE_CAPL—PCI Express* Capability List

B/D/F/Type: 0/6/0/PCI
Address Offset: A0–A1h
Default Value: 0010h
Access: RO
Size: 16 bits

This register enumerates the PCI Express capability structure.

| Bit | Access | Default Value | RST/ PWR | Description |
|------|--------|---------------|-------------|------------------------------------------------------------------------------------------------------------------------------------------------------------------------------------------------------------------------------------------------------------------------------------------------------------------|
| 15:8 | RO | 00h | Core | Pointer to Next Capability (PNC) : This value terminates the capabilities list. The Virtual Channel capability and any other PCI Express specific capabilities that are reported via this mechanism are in a separate capabilities list located entirely within PCI Express Extended Configuration Space. |
| 7:0 | RO | 10h | Core | Capability ID (CID) : Identifies this linked list item (capability structure) as being for PCI Express registers. |



8.34 PE_CAP—PCI Express* Capabilities

B/D/F/Type: 0/6/0/PCI
 Address Offset: A2–A3h
 Default Value: 0142h
 Access: RO, RWO
 Size: 16 bits

This register indicates PCI Express device capabilities.

| Bit | Access | Default Value | RST/ PWR | Description |
|-------|--------|---------------|-------------|----------------------------------------------------------------------------------------------------------------------------------------------------------------------------------------------------------------------------|
| 15:14 | RO | 00b | Core | Reserved |
| 13:9 | RO | 00h | Core | Interrupt Message Number (IMN) : Not Applicable or Implemented. Hardwired to 0. |
| 8 | RWO | 1b | Core | Slot Implemented (SI) : 0 = The PCI Express Link associated with this port is connected to an integrated component or is disabled. 1 = The PCI Express Link associated with this port is connected to a slot. |
| 7:4 | RO | 4h | Core | Device/Port Type (DPT) : Hardwired to 4h to indicate root port of PCI Express Root Complex. |
| 3:0 | RO | 2h | Core | PCI Express Capability Version (PCIECV) : Hardwired to 2h to indicate compliance to the PCI Express Capabilities Register Expansion ECN. |

8.35 DCAP—Device Capabilities

B/D/F/Type: 0/6/0/PCI
 Address Offset: A4–A7h
 Default Value: 00008000h
 Access: RO
 Size: 32 bits

This register indicates PCI Express device capabilities.

| Bit | Access | Default Value | RST/ PWR | Description |
|-------|--------|---------------|-------------|--------------------------------------------------------------------------------------------------------------------------------------------------------------------------------------------------|
| 31:16 | RO | 0000h | Core | Reserved |
| 15 | RO | 1b | Core | Role Based Error Reporting (RBER) : This bit indicates that this device implements the functionality defined in the Error Reporting ECN as required by the PCI Express 1.1 specification. |
| 14:6 | RO | 000h | Core | Reserved |
| 5 | RO | 0b | Core | Extended Tag Field Supported (ETFS) : Hardwired to indicate support for 5-bit Tags as a Requestor. |
| 4:3 | RO | 00b | Core | Phantom Functions Supported (PFS) : Not Applicable or Implemented. Hardwired to 0. |
| 2:0 | RO | 000b | Core | Max Payload Size (MPS) : Hardwired to indicate 128B max supported payload for Transaction Layer Packets (TLP). |



8.36 DCTL—Device Control

B/D/F/Type: 0/6/0/PCI
 Address Offset: A8–A9h
 Default Value: 0000h
 Access: RW, RO
 Size: 16 bits

This register provides control for PCI Express device specific capabilities.

The error reporting enable bits are in reference to errors detected by this device, not error messages received across the link. The reporting of error messages (ERR_CORR, ERR_NONFATAL, ERR_FATAL) received by Root Port is controlled exclusively by Root Port Command Register.

| Bit | Access | Default Value | RST/PWR | Description |
|------|--------|---------------|---------|-----------------------------------------------------------------------------------------------------------------------------------------------------------------------------------------------------------------------------------------------------------------------------------------------------------------------------------------------------------------------------------------------------------------------------------------------------------------------------------------------|
| 15:8 | RO | 0h | Core | Reserved |
| 7:5 | RW | 000b | Core | <p>Max Payload Size (MPS): 000 = 128B max supported payload for Transaction Layer Packets (TLP). As a receiver, the Device must handle TLPs as large as the set value; as transmitter, the Device must not generate TLPs exceeding the set value.</p> <p>All other encodings are reserved. Hardware will actually ignore this field. It is writeable only to support compliance testing.</p> |
| 4 | RO | 0b | Core | Reserved |
| 3 | RW | 0b | Core | <p>Unsupported Request Reporting Enable (URRE): When set, this bit allows signaling ERR_NONFATAL, ERR_FATAL, or ERR_CORR to the Root Control register when detecting an unmasked Unsupported Request (UR). An ERR_CORR is signaled when an unmasked Advisory Non-Fatal UR is received. An ERR_FATAL or ERR_NONFATAL is sent to the Root Control register when an uncorrectable non-Advisory UR is received with the severity bit set in the Uncorrectable Error Severity register.</p> |
| 2 | RW | 0b | Core | <p>Fatal Error Reporting Enable (FERE): When set, this bit enables signaling of ERR_FATAL to the Root Control register due to internally detected errors or error messages received across the link. Other bits also control the full scope of related error reporting.</p> |
| 1 | RW | 0b | Core | <p>Non-Fatal Error Reporting Enable (NERE): When set, this bit enables signaling of ERR_NONFATAL to the Root Control register due to internally detected errors or error messages received across the link. Other bits also control the full scope of related error reporting.</p> |
| 0 | RW | 0b | Core | <p>Correctable Error Reporting Enable (CERE): When set, this bit enables signaling of ERR_CORR to the Root Control register due to internally detected errors or error messages received across the link. Other bits also control the full scope of related error reporting.</p> |



8.37 DSTS—Device Status

B/D/F/Type: 0/6/0/PCI
 Address Offset: AA–ABh
 Default Value: 0000h
 Access: RO, RWC
 Size: 16 bits

This register reflects status corresponding to controls in the Device Control register. The error reporting bits are in reference to errors detected by this device, not errors messages received across the link.

| Bit | Access | Default Value | RST/ PWR | Description |
|------|--------|---------------|-------------|-------------------------------------------------------------------------------------------------------------------------------------------------------------------------------------------------------------------------------------------------------------------------------------------------------------------------------------------------------------------------------------------------------------------------------------------------------------------------------------------------------------------------------------------|
| 15:6 | RO | 000h | Core | Reserved |
| 5 | RO | 0b | Core | Transactions Pending (TP): 0 = All pending transactions (including completions for any outstanding non-posted requests on any used virtual channel) have been completed. 1 = Indicates that the device has transaction(s) pending (including completions for any outstanding non-posted requests for all used Traffic Classes). |
| 4 | RO | 0b | Core | Reserved |
| 3 | RWC | 0b | Core | Unsupported Request Detected (URD): When set, this bit indicates that the Device received an Unsupported Request. Errors are logged in this register regardless of whether error reporting is enabled or not in the Device Control Register. Additionally, the Non-Fatal Error Detected bit or the Fatal Error Detected bit is set according to the setting of the Unsupported Request Error Severity bit. In production systems setting the Fatal Error Detected bit is not an option as support for AER will not be reported. |
| 2 | RWC | 0b | Core | Fatal Error Detected (FED): When set, this bit indicates that fatal error(s) were detected. Errors are logged in this register regardless of whether error reporting is enabled or not in the Device Control register. When Advanced Error Handling is enabled, errors are logged in this register regardless of the settings of the uncorrectable error mask register. |
| 1 | RWC | 0b | Core | Non-Fatal Error Detected (NFED): When set, this bit indicates that non-fatal error(s) were detected. Errors are logged in this register regardless of whether error reporting is enabled or not in the Device Control register. When Advanced Error Handling is enabled, errors are logged in this register regardless of the settings of the uncorrectable error mask register. |
| 0 | RWC | 0b | Core | Correctable Error Detected (CED): When set, this bit indicates that correctable error(s) were detected. Errors are logged in this register regardless of whether error reporting is enabled or not in the Device Control register. When Advanced Error Handling is enabled, errors are logged in this register regardless of the settings of the correctable error mask register. |



8.38 LCAP—Link Capabilities

B/D/F/Type: 0/6/0/PCI
 Address Offset: AC–AFh
 Default Value: 03214D02h
 Access: RO, RWO
 Size: 32 bits

This register indicates PCI Express device specific capabilities.

| Bit | Access | Default Value | RST/ PWR | Description |
|-------|--------|---------------|-------------|--------------------------------------------------------------------------------------------------------------------------------------------------------------------------------------------------------------------------------------------------------------------------------------------------------------------------------------------------------------------------------------------------------------------------------------------------------------------------------------------------------------------------------------------------------------------------------------------------------------------------------------------------------------------------------------------------------------|
| 31:24 | RO | 03h | Core | Port Number (PN): This field indicates the PCI Express port number for the given PCI Express link. Matches the value in Element Self Description[31:24]. |
| 23:22 | RO | 000b | Core | Reserved |
| 21 | RO | 1b | Core | Link Bandwidth Notification Capability: A value of 1b indicates support for the Link Bandwidth Notification status and interrupt mechanisms. This capability is required for all Root Ports and Switch downstream ports supporting Links wider than x1 and/or multiple Link speeds. This field is not applicable and is reserved for Endpoint devices, PCI Express to PCI/PCI-X bridges, and Upstream Ports of Switches. Devices that do not implement the Link Bandwidth Notification capability must hardwire this bit to 0b. |
| 20 | RO | 0b | Core | Data Link Layer Link Active Reporting Capable (DLLARC): For a Downstream Port, this bit must be set to 1b if the component supports the optional capability of reporting the DL_Active state of the Data Link Control and Management State Machine. For Upstream Ports and components that do not support this optional capability, this bit must be hardwired to 0b. |
| 19 | RO | 0b | Core | Surprise Down Error Reporting Capable (SDERC): For a Downstream Port, this bit must be set to 1b if the component supports the optional capability of detecting and reporting a Surprise Down error condition. For Upstream Ports and components that do not support this optional capability, this bit must be hardwired to 0b. |
| 18 | RO | 0b | Core | Clock Power Management (CPM): A value of 1b in this bit indicates that the component tolerates the removal of any reference clock(s) when the link is in the L1 and L2/3 Ready link states. A value of 0b indicates the component does not have this capability and that reference clock(s) must not be removed in these link states. This capability is applicable only in form factors that support "clock request" (CLKREQ#) capability. For a multi-function device, each function indicates its capability independently. Power Management configuration software must only permit reference clock removal if all functions of the multifunction device indicate a 1b in this bit. |
| 17:15 | RWO | 010b | Core | L1 Exit Latency (L1ELAT): Indicates the length of time this Port requires to complete the transition from L1 to L0. The value 010 b indicates the range of 2 us to less than 4 us. Both bytes of this register that contain a portion of this field must be written simultaneously in order to prevent an intermediate (and undesired) value from ever existing. |

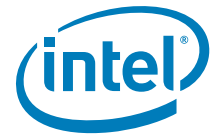

| Bit | Access | Default Value | RST/ PWR | Description |
|-------|--------|---------------|-------------|----------------------------------------------------------------------------------------------------------------------------------------------------------------------------------------------------------------------------------------------------------------|
| 14:12 | RO | 100b | Core | Reserved |
| 11:10 | RWO | 11b | Core | Active State Link PM Support (ASLPMS): The MCH supports ASPM L1. |
| 9:4 | RO | 10h | Core | Max Link Width (MLW): Indicates the maximum number of lanes supported for this link. 10h = x16 |
| 3:0 | RO | 2h | Core | Max Link Speed (MLS): Supported Link Speed - This field indicates the supported Link speed(s) of the associated Port. 0001b = 2.5GT/s Link speed supported 0010b = 5.0GT/s and 2.5GT/s Link speeds supported All other encodings are reserved. |

8.39 LCTL—Link Control

B/D/F/Type: 0/6/0/PCI
 Address Offset: B0–B1h
 Default Value: 0000h
 Access: RO, RW, RW/SC
 Size: 16 bits

This register allows control of PCI Express link.

| Bit | Access | Default Value | RST/ PWR | Description |
|-------|--------|---------------|-------------|--------------------------------------------------------------------------------------------------------------------------------------------------------------------------------------------------------------------------------------------------------------------------------------------------------------------------------------------------------------------------------------------------------------------------------------|
| 15:12 | RO | 0000000b | Core | Reserved |
| 11 | RW | 0b | Core | Link Autonomous Bandwidth Interrupt Enable: When Set, this bit enables the generation of an interrupt to indicate that the Link Autonomous Bandwidth Status bit has been set. This bit is not applicable and is reserved for Endpoint devices, PCI Express to PCI/PCI-X bridges, and Upstream Ports of Switches. Devices that do not implement the Link Bandwidth Notification capability must hardwire this bit to 0b. |
| 10 | RW | 0b | Core | Link Bandwidth Management Interrupt Enable: When Set, this bit enables the generation of an interrupt to indicate that the Link Bandwidth Management Status bit has been set. This bit is not applicable and is reserved for Endpoint devices, PCI Express to PCI/PCI-X bridges, and Upstream Ports of Switches. |
| 9 | RO | 0b | Core | Hardware Autonomous Width Disable: When Set, this bit disables hardware from changing the Link width for reasons other than attempting to correct unreliable Link operation by reducing Link width. Devices that do not implement the ability autonomously to change Link width are permitted to hardwire this bit to 0b. The MCH does not support autonomous width change. So, this bit is "RO". |



| Bit | Access | Default Value | RST/ PWR | Description |
|-----|--------|---------------|-------------|----------------------------------------------------------------------------------------------------------------------------------------------------------------------------------------------------------------------------------------------------------------------------------------------------------------------------------------------------------------------------------------------------------------------------------------------------------------------------------------------------------------------------------------------------------------------------------------------------------------------------------------------------------------------------------------------------------------|
| 8 | RO | 0b | Core | <p>Enable Clock Power Management (ECPM): Applicable only for form factors that support a "Clock Request" (CLKREQ#) mechanism, this enable functions as follows:</p> <p>0 = Clock power management is disabled and device must hold CLKREQ# signal low</p> <p>1 = The device is permitted to use CLKREQ# signal to power manage link clock according to protocol defined in appropriate form factor specification.</p> <p>Default value of this field is 0b.</p> <p>Components that do not support Clock Power Management (as indicated by a 0b value in the Clock Power Management bit of the Link Capabilities Register) must hardwire this bit to 0b.</p> |
| 7 | RW | 0b | Core | Reserved |
| 6 | RW | 0b | Core | <p>Common Clock Configuration (CCC):</p> <p>0 = Indicates that this component and the component at the opposite end of this Link are operating with asynchronous reference clock.</p> <p>1 = Indicates that this component and the component at the opposite end of this Link are operating with a distributed common reference clock.</p> <p>The state of this bit affects the N_FTS value advertised during link training.</p> |
| 5 | RW/SC | 0b | Core | <p>Retrain Link (RL):</p> <p>0 = Normal operation.</p> <p>1 = Full Link retraining is initiated by directing the Physical Layer LTSSM from L0 or L1 states to the Recovery state.</p> <p>This bit always returns 0 when read.</p> <p>This bit is cleared automatically (no need to write a 0).</p> <p>It is permitted to write 1b to this bit while simultaneously writing modified values to other fields in this register. If the LTSSM is not already in Recovery or Configuration, the resulting Link training must use the modified values. If the LTSSM is already in Recovery or Configuration, the modified values are not required to affect the Link training that's already in progress.</p> |
| 4 | RW | 0b | Core | <p>Link Disable (LD):</p> <p>0 = Normal operation.</p> <p>1 = Link is disabled. Forces the LTSSM to transition to the Disabled state (via Recovery) from L0 or L1 states. Link retraining happens automatically on 0 to 1 transition, just like when coming out of reset.</p> <p>Writes to this bit are immediately reflected in the value read from the bit, regardless of actual Link state.</p> |
| 3 | RO | 0b | Core | Read Completion Boundary (RCB): Hardwired to 0 to indicate 64 byte. |
| 2 | RW | 0b | Core | Reserved |
| 1:0 | RW | 00b | Core | <p>Active State PM (ASPM): Controls the level of active state power management supported on the given link.</p> <p>00 = Disabled</p> <p>01 = Reserved</p> <p>10 = Reserved</p> <p>11 = L1 Entry Supported</p> |



8.40 LSTS—Link Status

B/D/F/Type: 0/6/0/PCI
 Address Offset: B2–B3h
 Default Value: 1000h
 Access: RWC, RO
 Size: 16 bits

This register indicates PCI Express link status.

| Bit | Access | Default Value | RST/ PWR | Description |
|-----|--------|---------------|-------------|-------------------------------------------------------------------------------------------------------------------------------------------------------------------------------------------------------------------------------------------------------------------------------------------------------------------------------------------------------------------------------------------------------------------------------------------------------------------------------------------------------------------------------------------------------------------------------------------------------------------------------------------------------------------------------------------------------------------------------------------------------------------------------------------------------------------------------------|
| 15 | RWC | 0b | Core | <p>Link Autonomous Bandwidth Status (LABWS): This bit is set to 1b by hardware to indicate that hardware has autonomously changed link speed or width, without the port transitioning through DL_Down status, for reasons other than to attempt to correct unreliable link operation.</p> <p>This bit must be set if the Physical Layer reports a speed or width change was initiated by the downstream component that was indicated as an autonomous change.</p> |
| 14 | RWC | 0b | Core | <p>Link Bandwidth Management Status (LBWMS): This bit is set to 1b by hardware to indicate that either of the following has occurred without the port transitioning through DL_Down status: A link retraining initiated by a write of 1b to the Retrain Link bit has completed.</p> <p>NOTE: This bit is Set following any write of 1b to the Retrain Link bit, including when the Link is in the process of retraining for some other reason.</p> <p>Hardware has autonomously changed link speed or width to attempt to correct unreliable link operation, either through an LTSSM timeout or a higher level process</p> <p>This bit must be set if the Physical Layer reports a speed or width change was initiated by the downstream component that was not indicated as an autonomous change.</p> |
| 13 | RO | 0b | Core | <p>Data Link Layer Link Active (Optional) (DLLLA): This bit indicates the status of the Data Link Control and Management State Machine. It returns a 1b to indicate the DL_Active state, 0b otherwise.</p> <p>This bit must be implemented if the corresponding Data Link Layer Active Capability bit is implemented. Otherwise, this bit must be hardwired to 0b.</p> |
| 12 | RO | 1b | Core | <p>Slot Clock Configuration (SCC):</p> <p>0 = The device uses an independent clock irrespective of the presence of a reference on the connector. 1 = The device uses the same physical reference clock that the platform provides on the connector.</p> |
| 11 | RO | 0b | Core | <p>Link Training (LTRN): This bit indicates that the Physical Layer LTSSM is in the Configuration or Recovery state, or that 1b was written to the Retrain Link bit but Link training has not yet begun. Hardware clears this bit when the LTSSM exits the Configuration/ Recovery state once Link training is complete.</p> |



| Bit | Access | Default Value | RST/ PWR | Description |
|-----|--------|---------------|-------------|----------------------------------------------------------------------------------------------------------------------------------------------------------------------------------------------------------------------------------------------------------------------------------------------------------------------------------------------------------------------------------------------------------------------------------------------------------------------------------------------------------------------------------------------------------------------|
| 10 | RO | 0b | Core | Undefined: The value read from this bit is undefined. In previous versions of this specification, this bit was used to indicate a Link Training Error. System software must ignore the value read from this bit. System software is permitted to write any value to this bit. |
| 9:4 | RO | 00h | Core | Negotiated Link Width (NLW): Indicates negotiated link width. This field is valid only when the link is in the L0 or L1 states (after link width negotiation is successfully completed). 01h = x1 04h = 'x4 — This is not a supported PCIe Gen2.0 link width. Link width x4 is only valid when PCIe Gen1.1 I/O card is used in the secondary port. 08h = x8 — This is not a supported PCIe Gen2.0 link width. Link width x8 is only valid when PCIe Gen1.1 I/O card is used in the secondary port. 10h = x16 All other encodings are reserved. |
| 3:0 | RO | 0h | Core | Current Link Speed (CLS): This field indicates the negotiated Link speed of the given PCI Express Link. Defined encodings are: 0001b = 5.0 GT/s PCI Express Link 0010b = 5 GT/s PCI Express Link All other encodings are reserved. The value in this field is undefined when the Link is not up. |



8.41 SLOTCAP—Slot Capabilities

B/D/F/Type: 0/6/0/PCI
 Address Offset: B4–B7h
 Default Value: 00040000h
 Access: RWO, RO
 Size: 32 bits

PCI Express Slot related registers.

| Bit | Access | Default Value | RST/ PWR | Description |
|-------|--------|---------------|-------------|-------------------------------------------------------------------------------------------------------------------------------------------------------------------------------------------------------------------------------------------------------------------------------------------------------------------------------------------------------------|
| 31:19 | RWO | 0000h | Core | Physical Slot Number (PSN) : Indicates the physical slot number attached to this Port. |
| 18 | RO | 1b | Core | Reserved |
| 17 | RO | 0b | Core | Electromechanical Interlock Present (EIP) : When set to 1b, this bit indicates that an Electromechanical Interlock is implemented on the chassis for this slot. |
| 16:15 | RWO | 00b | Core | Slot Power Limit Scale (SPLS) : Specifies the scale used for the Slot Power Limit Value. 00 = 1.0x 01 = 0.1x 10 = 0.01x 11 = 0.001x If this field is written, the link sends a Set_Slot_Power_Limit message. |
| 14:7 | RWO | 00h | Core | Slot Power Limit Value (SPLV) : In combination with the Slot Power Limit Scale value, specifies the upper limit on power supplied by slot. Power limit (in Watts) is calculated by multiplying the value in this field by the value in the Slot Power Limit Scale field. If this field is written, the link sends a Set_Slot_Power_Limit message. |
| 6:5 | RO | 00b | Core | Reserved |
| 4 | RO | 0b | Core | Power Indicator Present (PIP) : When set to 1b, this bit indicates that a Power Indicator is electrically controlled by the chassis for this slot. |
| 3 | RO | 0b | Core | Attention Indicator Present (AIP) : When set to 1b, this bit indicates that an Attention Indicator is electrically controlled by the chassis. |
| 2 | RO | 0b | Core | MRL Sensor Present (MSP) : When set to 1b, this bit indicates that an MRL Sensor is implemented on the chassis for this slot. |
| 1 | RO | 0b | Core | Power Controller Present (PCP) : When set to 1b, this bit indicates that a software programmable Power Controller is implemented for this slot/adapter (depending on form factor). |
| 0 | RO | 0b | Core | Attention Button Present (ABP) : When set to 1b, this bit indicates that an Attention Button for this slot is electrically controlled by the chassis. |



8.42 SLOTCTL—Slot Control

B/D/F/Type: 0/6/0/PCI
 Address Offset: B8–B9h
 Default Value: 0000h
 Access: RO, RW
 Size: 16 bits

PCI Express Slot related registers.

| Bit | Access | Default Value | RST/ PWR | Description |
|-------|--------|---------------|-------------|--------------------------------------------------------------------------------------------------------------------------------------------------------------------------------------------------------------------------------------------------------------------------------------------------------------------------------------------------------------------------------------------------------------------------------------------------------------------------------------------------------------------------------------------------------------------------------------------------------------------------------------------------------------------------------------------------------------------------------------------------------------------------------------------------------------------------------------------------------------------------------------------------------------|
| 15:13 | RO | 000b | Core | Reserved |
| 12 | RO | 0b | Core | Data Link Layer State Changed Enable (DLLSCE): If the Data Link Layer Link Active capability is implemented, when set to 1b, this field enables software notification when Data Link Layer Link Active field is changed. If the Data Link Layer Link Active capability is not implemented, this bit is permitted to be read only with a value of 0b. |
| 11 | RO | 0b | Core | Electromechanical Interlock Control (EIC): If an Electromechanical Interlock is implemented, a write of 1b to this field causes the state of the interlock to toggle. A write of 0b to this field has no effect. A read to this register always returns a 0. |
| 10 | RO | 0b | Core | Power Controller Control (PCC): If a Power Controller is implemented, this field when written sets the power state of the slot per the defined encodings. Reads of this field must reflect the value from the latest write, unless software issues a write without waiting for the previous command to complete in which case the read value is undefined. Depending on the form factor, the power is turned on/off either to the slot or within the adapter. Note that in some cases the power controller may autonomously remove slot power or not respond to a power-up request based on a detected fault condition, independent of the Power Controller Control setting. 0 = Power On 1 = Power Off If the Power Controller Implemented field in the Slot Capabilities register is set to 0b, then writes to this field have no effect and the read value of this field is undefined. |
| 9:8 | RO | 00b | Core | Power Indicator Control (PIC): If a Power Indicator is implemented, writes to this field set the Power Indicator to the written state. Reads of this field must reflect the value from the latest write, unless software issues a write without waiting for the previous command to complete in which case the read value is undefined. 00 = Reserved 01 = On 10 = Blink 11 = Off If the Power Indicator Present bit in the Slot Capabilities register is 0b, this field is permitted to be read-only with a value of 00b. |



| Bit | Access | Default Value | RST/ PWR | Description |
|-----|--------|---------------|-------------|------------------------------------------------------------------------------------------------------------------------------------------------------------------------------------------------------------------------------------------------------------------------------------------------------------------------------------------------------------------------------------------------------------------------------------------------------------------------------------------------------------------------------------------------------------------------------------------------------------------------------------------------------------------------------------------------------------------------------------------------------------|
| 7:6 | RO | 00b | Core | <p>Attention Indicator Control (AIC): If an Attention Indicator is implemented, writes to this field set the Attention Indicator to the written state.</p> <p>Reads of this field must reflect the value from the latest write, unless software issues a write without waiting for the previous command to complete in which case the read value is undefined. If the indicator is electrically controlled by chassis, the indicator is controlled directly by the downstream port through implementation specific mechanisms.</p> <p>00 = Reserved 01 = On 10 = Blink 11 = Off</p> <p>If the Attention Indicator Present bit in the Slot Capabilities register is 0b, this field is permitted to be read only with a value of 00b.</p> |
| 5:4 | RO | 00b | Core | Reserved |
| 3 | RW | 0b | Core | <p>Presence Detect Changed Enable (PDCE): When set to 1b, this bit enables software notification on a presence detect changed event.</p> |
| 2 | RO | 0b | Core | <p>MRL Sensor Changed Enable (MSCE): When set to 1b, this bit enables software notification on a MRL sensor changed event.</p> <p>Default value of this field is 0b. If the MRL Sensor Present field in the Slot Capabilities register is set to 0b, this bit is permitted to be read-only with a value of 0b.</p> |
| 1 | RO | 0b | Core | <p>Power Fault Detected Enable (PFDE): When set to 1b, this bit enables software notification on a power fault event.</p> <p>Default value of this field is 0b. If Power Fault detection is not supported, this bit is permitted to be read-only with a value of 0b</p> |
| 0 | RO | 0b | Core | <p>Button Pressed Enable (ABPE): When set to 1b, this bit enables software notification on an attention button pressed event.</p> |



8.43 SLOTSTS—Slot Status

B/D/F/Type: 0/6/0/PCI
 Address Offset: BA–BBh
 Default Value: 0000h
 Access: RO, RWC
 Size: 16 bits

PCI Express Slot related registers.

| Bit | Access | Default Value | RST/ PWR | Description |
|------|--------|---------------|-------------|---------------------------------------------------------------------------------------------------------------------------------------------------------------------------------------------------------------------------------------------------------------------------------------------------------------------------------------------------------------------------------------------------------------------------------------------------------------------------------------------------------------------------------------------------------------------------------------------------------------------------------------------------------------------------------------------------------------------------------------------------|
| 15:7 | RO | 0000000b | Core | Reserved |
| 6 | RO | 0b | Core | <p>Presence Detect State (PDS): This bit indicates the presence of an adapter in the slot, reflected by the logical "OR" of the Physical Layer in-band presence detect mechanism and, if present, any out-of-band presence detect mechanism defined for the slot's corresponding form factor. Note that the in-band presence detect mechanism requires that power be applied to an adapter for its presence to be detected.</p> <p>0 = Slot Empty 1 = Card Present in Slot</p> <p>This register must be implemented on all Downstream Ports that implement slots. For Downstream Ports not connected to slots (where the Slot Implemented bit of the PCI Express Capabilities Register is 0b), this bit must return 1b.</p> |
| 5:4 | RO | 00b | Core | Reserved |
| 3 | RWC | 0b | Core | <p>Detect Changed (PDC): This bit is set when the value reported in Presence Detect State is changed.</p> |
| 2 | RO | 0b | Core | <p>MRL Sensor Changed (MSC): If an MRL sensor is implemented, this bit is set when a MRL Sensor state change is detected. If an MRL sensor is not implemented, this bit must not be set.</p> |
| 1 | RO | 0b | Core | <p>Power Fault Detected (PFD): If a Power Controller that supports power fault detection is implemented, this bit is set when the Power Controller detects a power fault at this slot. Note that, depending on hardware capability, it is possible that a power fault can be detected at any time, independent of the Power Controller Control setting or the occupancy of the slot. If power fault detection is not supported, this bit must not be set.</p> |
| 0 | RO | 0b | Core | <p>Attention Button Pressed (ABP): If an Attention Button is implemented, this bit is set when the attention button is pressed. If an Attention Button is not supported, this bit must not be set.</p> |



8.44 RCTL—Root Control

B/D/F/Type: 0/6/0/PCI
 Address Offset: BC–BDh
 Default Value: 0000h
 Access: RO, RW
 Size: 16 bits

This register allows control of PCI Express Root Complex specific parameters. The system error control bits in this register determine if corresponding SERRs are generated when our device detects an error (reported in this device's Device Status register) or when an error message is received across the link. Reporting of SERR as controlled by these bits takes precedence over the SERR Enable in the PCI Command Register.

| Bit | Access | Default Value | RST/ PWR | Description |
|------|--------|---------------|-------------|-----------------------------------------------------------------------------------------------------------------------------------------------------------------------------------------------------------------------------------------------------------------------------------------------------------------------------------------------------------------------------------------|
| 15:4 | RO | 000h | Core | Reserved |
| 3 | RW | 0b | Core | PME Interrupt Enable (PMEIE): 0 = No interrupts are generated as a result of receiving PME messages. 1 = Enables interrupt generation upon receipt of a PME message as reflected in the PME Status bit of the Root Status Register. A PME interrupt is also generated if the PME Status bit of the Root Status Register is set when this bit is set from a cleared state. |
| 2 | RW | 0b | Core | System Error on Fatal Error Enable (SEFEE): This bit controls the Root Complex's response to fatal errors. 0 = No SERR generated on receipt of fatal error. 1 = Indicates that an SERR should be generated if a fatal error is reported by any of the devices in the hierarchy associated with this Root Port, or by the Root Port itself. |
| 1 | RW | 0b | Core | System Error on Non-Fatal Uncorrectable Error Enable (SENFUEE): This bit controls the Root Complex's response to non-fatal errors. 0 = No SERR generated on receipt of non-fatal error. 1 = Indicates that an SERR should be generated if a non-fatal error is reported by any of the devices in the hierarchy associated with this Root Port, or by the Root Port itself. |
| 0 | RW | 0b | Core | System Error on Correctable Error Enable (SECEE): This bit controls the Root Complex's response to correctable errors. 0 = No SERR generated on receipt of correctable error. 1 = Indicates that an SERR should be generated if a correctable error is reported by any of the devices in the hierarchy associated with this Root Port, or by the Root Port itself. |



8.45 RSTS—Root Status

B/D/F/Type: 0/6/0/PCI
 Address Offset: C0–C3h
 Default Value: 00000000h
 Access: RO, RWC
 Size: 32 bits

This register provides information about PCI Express Root Complex specific parameters.

| Bit | Access | Default Value | RST/ PWR | Description |
|-------|--------|---------------|-------------|-----------------------------------------------------------------------------------------------------------------------------------------------------------------------------------------------------------------------------------------------------------------------------------------------------------------------------------------------------|
| 31:18 | RO | 0000h | Core | Reserved |
| 17 | RO | 0b | Core | PME Pending (PMEP): This bit indicates that another PME is pending when the PME Status bit is set. When the PME Status bit is cleared by software; the PME is delivered by hardware by setting the PME Status bit again and updating the Requestor ID appropriately. The PME pending bit is cleared by hardware if no more PMEs are pending. |
| 16 | RWC | 0b | Core | PME Status (PMES): This bit indicates that PME was asserted by the requestor ID indicated in the PME Requestor ID field. Subsequent PMEs are kept pending until the status register is cleared by writing a 1 to this field. |
| 15:0 | RO | 0000h | Core | PME Requestor ID (PMERID): This field indicates the PCI requestor ID of the last PME requestor. |

8.46 PELC—PCI Express Legacy Control

B/D/F/Type: 0/6/0/PCI
 Address Offset: EC–EFh
 Default Value: 00000000h
 Access: RO, RW
 Size: 32 bits

This register controls functionality that is needed by Legacy (non-PCI Express aware) OSs during run time.

| Bit | Access | Default Value | RST/ PWR | Description |
|------|--------|---------------|-------------|--------------------------------------------------------------------------------------------------------------------------------------------------------------------------------------------------------------------------------------------------------------------------------------------------------------------------------------------------------------------|
| 31:3 | RO | 00000000h | Core | Reserved |
| 2 | RW | 0b | Core | PME GPE Enable (PMEGPE): 0 = Do not generate GPE PME message when PME is received. 1 = Generate a GPE PME message when PME is received (Assert_PMEGPE and Deassert_PMEGPE messages on DMI). This enables the MCH to support PMEs on the PCI Express port under legacy OSs. |
| 1 | RO | 0b | Core | Reserved |
| 0 | RW | 0b | Core | General Message GPE Enable (GENGPE): 0 = Do not forward received GPE assert/de-assert messages. 1 = Forward received GPE assert/de-assert messages. These general GPE message can be received via the PCI Express port from an external Intel device and will be subsequently forwarded to the ICH (via Assert_GPE and Deassert_GPE messages on DMI). |



8.47 VCECH—Virtual Channel Enhanced Capability Header

B/D/F/Type: 0/6/0/MMR
 Address Offset: 100–103h
 Default Value: 14010002h
 Access: RO
 Size: 32 bits

This register indicates PCI Express device Virtual Channel capabilities. Extended capability structures for PCI Express devices are located in PCI Express extended configuration space and have different field definitions than standard PCI capability structures.

| Bit | Access | Default Value | RST/ PWR | Description |
|-------|--------|---------------|-------------|---------------------------------------------------------------------------------------------------------------------------------------------------------------------------------------------------------------------------|
| 31:20 | RO | 140h | Core | Pointer to Next Capability (PNC): The Link Declaration Capability is the next in the PCI Express extended capabilities list. |
| 19:16 | RO | 1h | Core | PCI Express Virtual Channel Capability Version (PCIEVCCV): Hardwired to 1 to indicate compliances with the 1.1 version of the PCI Express specification. Note: This version does not change for 2.0 compliance. |
| 15:0 | RO | 0002h | Core | Extended Capability ID (ECID): Value of 0002h identifies this linked list item (capability structure) as being for PCI Express Virtual Channel registers. |

8.48 PVCCAP1—Port VC Capability Register 1

B/D/F/Type: 0/6/0/MMR
 Address Offset: 104–107h
 Default Value: 00000000h
 Access: RO
 Size: 32 bits

This register describes the configuration of PCI Express Virtual Channels associated with this port.

| Bit | Access | Default Value | RST/ PWR | Description |
|------|--------|---------------|-------------|----------------------------------------------------------------------------------------------------------------------------------------------------------------------------------------------------------------------------------------------------------------------------------------------------------------------------------------------------------------|
| 31:7 | RO | 00000h | Core | Reserved |
| 6:4 | RO | 000b | Core | Low Priority Extended VC Count (LPEVCC): This field indicates the number of (extended) Virtual Channels in addition to the default VC belonging to the low-priority VC (LPVC) group that has the lowest priority with respect to other VC resources in a strict-priority VC Arbitration. The value of 0 in this field implies strict VC arbitration. |
| 3 | RO | 0b | Core | Reserved |
| 2:0 | RO | 000b | Core | Extended VC Count (EVCC): This field indicates the number of (extended) Virtual Channels in addition to the default VC supported by the device. |



8.49 PVCCAP2—Port VC Capability Register 2

B/D/F/Type: 0/6/0/MMR
Address Offset: 108–10Bh
Default Value: 00000000h
Access: RO
Size: 32 bits

This register describes the configuration of PCI Express Virtual Channels associated with this port.

| Bit | Access | Default Value | RST/ PWR | Description |
|-------|--------|---------------|-------------|---------------------------------------------------------------------------------------------------------------------------------------------------------------------------------------------------------------------------------------------------------------------------------------------------------------------------------------------|
| 31:24 | RO | 00h | Core | VC Arbitration Table Offset (VCATO): This field indicates the location of the VC Arbitration Table. This field contains the zero-based offset of the table in DQWORDS (16 bytes) from the base address of the Virtual Channel Capability Structure. A value of 0 indicates that the table is not present (due to fixed VC priority). |
| 23:0 | RO | 0000h | Core | Reserved |

8.50 PVCCTL—Port VC Control

B/D/F/Type: 0/6/0/MMR
Address Offset: 10C–10Dh
Default Value: 0000h
Access: RO, RW
Size: 16 bits

| Bit | Access | Default Value | RST/ PWR | Description |
|------|--------|---------------|-------------|-----------------------------------------------------------------------------------------------------------------------------------------------------------------------------------------------------------------------------------------------|
| 15:4 | RO | 000h | Core | Reserved |
| 3:1 | RW | 000b | Core | VC Arbitration Select (VCAS): This field will be programmed by software to the only possible value as indicated in the VC Arbitration Capability field. Since there is no other VC supported than the default, this field is reserved. |
| 0 | RO | 0b | Core | Reserved |

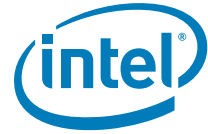

8.51 VCORCAP—VCO Resource Capability

B/D/F/Type: 0/6/0/MMR
 Address Offset: 110–113h
 Default Value: 00000001h
 Access: RO
 Size: 32 bits

| Bit | Access | Default Value | RST/PWR | Description |
|-------|--------|---------------|---------|---------------------------------------------------------------------------------------------------------------------------------------------------------------------------------------------------------------------------------------------------------------------------------------------------------------------------------------------------------------------------------------------------------------------------------------------------------------------------------------------------------------------------------------------------------------------------------------------------------------------------------------------------------------------------------------------------------------------------------------------------------------------------------------------------------------------------------------------------------------------------------------------------------------------------------------------------------------------------------------------------------------------------------------------------------------------------------------------------------------------------------|
| 31:16 | RO | 0000h | Core | Reserved |
| 15 | RO | 0b | Core | Reject Snoop Transactions (RSNPT): 0 = Transactions with or without the No Snoop bit set within the Transaction Layer Packet header are allowed on this VC. 1 = When Set, any transaction for which the No Snoop attribute is applicable but is not Set within the TLP Header will be rejected as an Unsupported Request. |
| 14:8 | RO | 0000h | Core | Reserved |
| 7:0 | RO | 01h | Core | Port Arbitration Capability: Indicates types of Port Arbitration supported by the VC resource. This field is valid for all Switch Ports, Root Ports that support peer-to-peer traffic, and RCRBs, but not for PCI Express Endpoint devices or Root Ports that do not support peer to peer traffic. Each bit location within this field corresponds to a Port Arbitration Capability defined below. When more than one bit in this field is Set, it indicates that the VC resource can be configured to provide different arbitration services. Software selects among these capabilities by writing to the Port Arbitration Select field (see below). Bit[0] = Default = 01b; Non-configurable hardware-fixed arbitration scheme, e.g., Round Robin (RR) Bit[1] = Weighted Round Robin (WRR) arbitration with 32 phases Bit[2] = WRR arbitration with 64 phases Bit[3] = WRR arbitration with 128 phases Bit[4] = Time-based WRR with 128 phases Bit[5] = WRR arbitration with 256 phases Bits[6:7] = Reserved MCH default indicates "Non-configurable hardware-fixed arbitration scheme". |



8.52 VCORCTL—VCO Resource Control

B/D/F/Type: 0/6/0/MMR
 Address Offset: 114–117h
 Default Value: 800000FFh
 Access: RO, RW
 Size: 32 bits

This register controls the resources associated with PCI Express Virtual Channel 0.

| Bit | Access | Default Value | RST/ PWR | Description |
|-------|--------|---------------|-------------|-----------------------------------------------------------------------------------------------------------------------------------------------------------------------------------------------------------------------------------------------------------------------------------------------------------------------------------------------------------------------------------------------------------------------------------------------------------------------------------------------------------------------------------------------------|
| 31 | RO | 1b | Core | VCO Enable (VCOE) : For VCO, this is hardwired to 1 and read only as VCO can never be disabled. |
| 30:27 | RO | 0h | Core | Reserved |
| 26:24 | RO | 000b | Core | VCO ID (VCOID) : This field assigns a VC ID to the VC resource. For VCO this is hardwired to 0 and read only. |
| 23:20 | RO | 0000h | Core | Reserved |
| 19:17 | RW | 000b | Core | Port Arbitration Select : This field configures the VC resource to provide a particular Port Arbitration service. This field is valid for RCRBs, Root Ports that support peer to peer traffic, and Switch Ports, but not for PCI Express Endpoint devices or Root Ports that do not support peer to peer traffic. The permissible value of this field is a number corresponding to one of the asserted bits in the Port Arbitration Capability field of the VC resource. |
| 16:8 | RO | 00h | Core | Reserved |
| 7:1 | RW | 7Fh | Core | TC/VCO Map (TCVCOM) : This field indicates the TCs (Traffic Classes) that are mapped to the VC resource. Bit locations within this field correspond to TC values. For example, when bit 7 is set in this field, TC7 is mapped to this VC resource. When more than one bit in this field is set, it indicates that multiple TCs are mapped to the VC resource. To remove one or more TCs from the TC/VC Map of an enabled VC, software must ensure that no new or outstanding transactions with the TC labels are targeted at the given Link. |
| 0 | RO | 1b | Core | TC0/VCO Map (TC0VCOM) : Traffic Class 0 is always routed to VCO. |



8.53 VCORSTS—VCO Resource Status

B/D/F/Type: 0/6/0/MMR
 Address Offset: 11A–11Bh
 Default Value: 0002h
 Access: RO
 Size: 16 bits

This register reports the Virtual Channel specific status.

| Bit | Access | Default Value | RST/ PWR | Description |
|------|--------|---------------|-------------|---------------------------------------------------------------------------------------------------------------------------------------------------------------------------------------------------------------------------------------------------------------------------------------------------------------------------------------------------------------------------------------------------------------------------------------------------------------------------------------------------------------------------------------------------------------------------------------------------------------------------------------------------------------------------------|
| 15:2 | RO | 0000h | Core | Reserved |
| 1 | RO | 1b | Core | <p>VCO Negotiation Pending (VCONP): 0 = The VC negotiation is complete. 1 = The VC resource is still in the process of negotiation (initialization or disabling).</p> <p>This bit indicates the status of the process of Flow Control initialization. It is set by default on Reset, as well as whenever the corresponding Virtual Channel is Disabled or the Link is in the DL_Down state. It is cleared when the link successfully exits the FC_INIT2 state.</p> <p>Before using a Virtual Channel, software must check whether the VC Negotiation Pending fields for that Virtual Channel are cleared in both Components on a Link.</p> |
| 0 | RO | 0b | Core | Reserved |

8.54 RCLDECH—Root Complex Link Declaration Enhanced

B/D/F/Type: 0/6/0/MMR
 Address Offset: 140–143h
 Default Value: 00010005h
 Access: RO
 Size: 32 bits

This capability declares links from this element (PCI Express) to other elements of the root complex component to which it belongs. See PCI Express specification for link/topology declaration requirements.

| Bit | Access | Default Value | RST/ PWR | Description |
|-------|--------|---------------|-------------|-----------------------------------------------------------------------------------------------------------------------------------------------------------------------------------------------------------------------|
| 31:20 | RO | 000h | Core | Pointer to Next Capability (PNC): This is the last capability in the PCI Express extended capabilities list. |
| 19:16 | RO | 1h | Core | <p>Link Declaration Capability Version (LDCV): Hardwired to 1 to indicate compliances with the 1.1 version of the PCI Express specification.</p> <p>Note: This version does not change for 2.0 compliance.</p> |
| 15:0 | RO | 0005h | Core | Extended Capability ID (ECID): Value of 0005h identifies this linked list item (capability structure) as being for PCI Express Link Declaration Capability. |



8.55 ESD—Element Self Description

B/D/F/Type: 0/6/0/MMR
 Address Offset: 144–147h
 Default Value: 03000100h
 Access: RO, RWO
 Size: 32 bits

This register provides information about the root complex element containing this Link Declaration Capability.

| Bit | Access | Default Value | RST/ PWR | Description |
|-------|--------|---------------|-------------|------------------------------------------------------------------------------------------------------------------------------------------------------------------------------------------------------------------------------------------------------------------------------|
| 31:24 | RO | 03h | Core | Port Number (PN): This field specifies the port number associated with this element with respect to the component that contains this element. This port number value is used by the egress port of the component to provide arbitration to this Root Complex Element. |
| 23:16 | RWO | 00h | Core | Component ID (CID): This field indicates the physical component that contains this Root Complex Element. |
| 15:8 | RO | 01h | Core | Number of Link Entries (NLE): This field indicates the number of link entries following the Element Self Description. This field reports 1 (to Egress port only as we don't report any peer-to-peer capabilities in our topology). |
| 7:4 | RO | 0h | Core | Reserved |
| 3:0 | RO | 0h | Core | Element Type (ET): This field indicates Configuration Space Element. |

8.56 LE1D—Link Entry 1 Description

B/D/F/Type: 0/6/0/MMR
 Address Offset: 150–153h
 Default Value: 00000000h
 Access: RO, RWO
 Size: 32 bits

This register provides the first part of a Link Entry that declares an internal link to another Root Complex Element.

| Bit | Access | Default Value | RST/ PWR | Description |
|-------|--------|---------------|-------------|--------------------------------------------------------------------------------------------------------------------------------------------------------------------------------------------------------------------------------------------------------------------------|
| 31:24 | RO | 00h | Core | Target Port Number (TPN): This field specifies the port number associated with the element targeted by this link entry (Egress Port). The target port number is with respect to the component that contains this element as specified by the target component ID. |
| 23:16 | RWO | 00h | Core | Target Component ID (TCID): This field identifies the physical or logical component that is targeted by this link entry. |
| 15:2 | RO | 0000h | Core | Reserved |
| 1 | RO | 0b | Core | Link Type (LTYP): This bit indicates that the link points to memory-mapped space (for RCRB). The link address specifies the 64-bit base address of the target RCRB. |
| 0 | RWO | 0b | Core | Link Valid (LV): 0 = Link Entry is not valid and will be ignored. 1 = Link Entry specifies a valid link. |

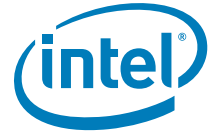

8.57 LE1A—Link Entry 1 Address

B/D/F/Type: 0/6/0/MMR
 Address Offset: 158–15Fh
 Default Value: 0000000000000000h
 Access: RO, RWO
 Size: 64 bits

This register provides the second part of a Link Entry that declares an internal link to another Root Complex Element.

| Bit | Access | Default Value | RST/ PWR | Description |
|-------|--------|---------------|-------------|--------------------------------------------------------------------------------------------------------------------------------------------------------|
| 63:32 | RO | 0000000 0h | Core | Reserved |
| 31:12 | RWO | 00000h | Core | Link Address (LA): This field provides the memory mapped base address of the RCRB that is the target element (Egress Port) for this link entry. |
| 11:0 | RO | 000h | Core | Reserved |

§ §

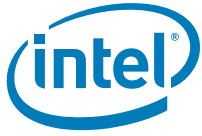

Host-Secondary PCI Express Bridge Registers (D6:F0) (Intel® 82P45 MCH Only)*



9 Integrated Graphics Registers (Device 2) (Intel® 82Q45, 82Q43, 82B43, 82G45, 82G43, 82G41 GMCH Only)

9.1 Integrated Graphics Registers (D2:F0)

Device 2 contains registers for the internal graphics functions. Table 15 lists the PCI configuration registers in order of ascending offset address.

Function 0 can be VGA compatible or not. This is selected through bit 1 of GGC register (Device 0, offset 52h).

Note: The following sections describe Device 2 PCI configuration registers only.

Table 15. Integrated Graphics Register Address Map (D2:F0)

| Address Offset | Register Symbol | Register Name | Default Value | Access |
|----------------|-----------------|---------------------------------------------------------|--------------------------|--------------------|
| 0–1h | VID2 | Vendor Identification | 8086h | RO |
| 2–3h | DID2 | Device Identification | see register description | RO |
| 4–5h | PCICMD2 | PCI Command | 0000h | RO, R/W |
| 6–7h | PCISTS2 | PCI Status | 0090h | RO |
| 8h | RID2 | Revision Identification | see register description | RO |
| 9–Bh | CC | Class Code | 030000h | RO |
| Ch | CLS | Cache Line Size | 00h | RO |
| Dh | MLT2 | Master Latency Timer | 00h | RO |
| Eh | HDR2 | Header Type | 80h | RO |
| 10–17h | GTTMMADR | Graphics Translation Table, Memory Mapped Range Address | 000000000 0000004h | R/W, RO |
| 18–1Fh | GMADR | Graphics Memory Range Address | 000000000 000000Ch | R/W, RO, R/W/L |
| 20–23h | IOBAR | I/O Base Address | 00000001h | RO, R/W |
| 2C–2Dh | SVID2 | Subsystem Vendor Identification | 0000h | R/WO |
| 2E–2Fh | SID2 | Subsystem Identification | 0000h | R/WO |
| 30–33h | ROMADR | Video BIOS ROM Base Address | 00000000h | RO |
| 34h | CAPPOINT | Capabilities Pointer | 90h | RO |
| 3Ch | INTRLINE | Interrupt Line | 00h | R/W |
| 3Dh | INTRPIN | Interrupt Pin | 01h | RO |
| 3Eh | MINGNT | Minimum Grant | 00h | RO |



Table 15. Integrated Graphics Register Address Map (D2:F0)

| Address Offset | Register Symbol | Register Name | Default Value | Access |
|----------------|-----------------|----------------------------------|-------------------------------------|--------------------|
| 3Fh | MAXLAT | Maximum Latency | 00h | RO |
| 40–4Ch | CAPID0 | Capability Identifier | 000000000 000000000 010C0009h | RO |
| 52–53h | MGGC | GMCH Graphics Control Register | 0030h | RO |
| 54–57h | DEVEN | Device Enable | 000023DBh | RO |
| 58–5Bh | SSRW | Software Scratch Read Write | 00000000h | R/W |
| 5C–5Fh | BSM | Base of Stolen Memory | 07800000h | RO |
| 60–61h | HSRW | Hardware Scratch Read Write | 0000h | R/W |
| 92–93h | MC | Message Control | 0000h | RO, R/W |
| 94–97h | MA | Message Address | 00000000h | R/W, RO |
| 98–99h | MD | Message Data | 0000h | R/W |
| C0h | GDRST | Graphics Debug Reset | 00h | RO, R/W/SC, R/W |
| D0–D1h | PMCAPID | Power Management Capabilities ID | 0001h | R/WO, RO |
| D2–D3h | PMCAP | Power Management Capabilities | 0022h | RO |
| D4–D5h | PMCS | Power Management Control/Status | 0000h | RO, R/W |
| E0–E1h | SWSMI | Software SMI | 0000h | R/W |



9.1.1 VID2—Vendor Identification

B/D/F/Type: 0/2/0/PCI
 Address Offset: 0-1h
 Default Value: 8086h
 Access: RO
 Size: 16 bits

This register combined with the Device Identification register uniquely identifies any PCI device.

| Bit | Access | Default Value | RST/PWR | Description |
|------|--------|---------------|---------|-----------------------------------------------------------------------------------------------------------|
| 15:0 | RO | 8086h | Core | Vendor Identification Number (VID): This field provides the PCI standard identification for Intel. |

9.1.2 DID2—Device Identification

B/D/F/Type: 0/2/0/PCI
 Address Offset: 2-3h
 Default Value: see description below
 Access: RO
 Size: 16 bits

This register combined with the Vendor Identification register uniquely identifies any PCI device.

| Bit | Access | Default Value | RST/PWR | Description |
|------|--------|-----------------|---------|---------------------------------------------------------------------------------------------------------------------------------------------------------------------------------------------------------------------------|
| 15:0 | RO | see description | Core | Device Identification Number (DID): This field is an identifier assigned to the GMCH core/primary PCI device. Refer to the <i>Intel® 4 Series Chipset Family Specification Update</i> for values in this register. |



9.1.3 PCICMD2—PCI Command

B/D/F/Type: 0/2/0/PCI
 Address Offset: 4-5h
 Default Value: 0000h
 Access: RO, R/W
 Size: 16 bits

This 16-bit register provides basic control over the IGD's ability to respond to PCI cycles. The PCICMD Register in the IGD disables the IGD PCI compliant master accesses to main memory.

| Bit | Access | Default Value | RST/PWR | Description |
|-------|--------|---------------|-----------|-------------------------------------------------------------------------------------------------------------------------------------------------------------------------------------------------------------------------------------------------------------------------------------|
| 15:11 | RO | 00h | Core | Reserved |
| 10 | R/W | 0b | FLR, Core | Interrupt Disable (INTDIS): This bit disables the device from asserting INTx#. 0 = Enable the assertion of this device's INTx# signal. 1 = Disable the assertion of this device's INTx# signal. DO_INTx messages will not be sent to DMI. |
| 9 | RO | 0b | Core | Fast Back-to-Back (FB2B): Not Implemented. Hardwired to 0. |
| 8 | RO | 0b | Core | SERR Enable (SERRE): Not Implemented. Hardwired to 0. |
| 7 | RO | 0b | Core | Address/Data Stepping Enable (ADSTEP): Not Implemented. Hardwired to 0. |
| 6 | RO | 0b | Core | Parity Error Enable (PERRE): Not Implemented. Hardwired to 0. Since the IGD belongs to the category of devices that does not corrupt programs or data in system memory or hard drives, the IGD ignores any parity error that it detects and continues with normal operation. |
| 5 | RO | 0b | Core | Video Palette Snooping (VPS): This bit is hardwired to 0 to disable snooping. |
| 4 | RO | 0b | Core | Memory Write and Invalidate Enable (MWIE): Hardwired to 0. The IGD does not support memory write and invalidate commands. |
| 3 | RO | 0b | Core | Special Cycle Enable (SCE): This bit is hardwired to 0. The IGD ignores Special cycles. |
| 2 | R/W | 0b | FLR, Core | Bus Master Enable (BME): 0 = Disable IGD bus mastering. 1 = Enable the IGD to function as a PCI compliant master. |
| 1 | R/W | 0b | FLR, Core | Memory Access Enable (MAE): This bit controls the IGD's response to memory space accesses. 0 = Disable. 1 = Enable. |
| 0 | R/W | 0b | FLR, Core | I/O Access Enable (IOAE): This bit controls the IGD's response to I/O space accesses. 0 = Disable. 1 = Enable. |



9.1.4 PCISTS2—PCI Status

B/D/F/Type: 0/2/0/PCI
 Address Offset: 6-7h
 Default Value: 0090h
 Access: RO
 Size: 16 bits

PCISTS is a 16-bit status register that reports the occurrence of a PCI compliant master abort and PCI compliant target abort.

PCISTS also indicates the DEVSEL# timing that has been set by the IGD.

| Bit | Access | Default Value | RST/PWR | Description |
|------|--------|---------------|---------|---------------------------------------------------------------------------------------------------------------------------------------------------------------------------------------------------------------------------------------------------|
| 15 | RO | 0b | Core | Detected Parity Error (DPE): Since the IGD does not detect parity, this bit is always hardwired to 0. |
| 14 | RO | 0b | Core | Signaled System Error (SSE): The IGD never asserts SERR#, therefore this bit is hardwired to 0. |
| 13 | RO | 0b | Core | Received Master Abort Status (RMAS): The IGD never gets a Master Abort, therefore this bit is hardwired to 0. |
| 12 | RO | 0b | Core | Received Target Abort Status (RTAS): The IGD never gets a Target Abort, therefore this bit is hardwired to 0. |
| 11 | RO | 0b | Core | Signaled Target Abort Status (STAS): Hardwired to 0. The IGD does not use target abort semantics. |
| 10:9 | RO | 00b | Core | DEVSEL Timing (DEVT): N/A. These bits are hardwired to 00. |
| 8 | RO | 0b | Core | Master Data Parity Error Detected (DPD): Since Parity Error Response is hardwired to disabled (and the IGD does not do any parity detection), this bit is hardwired to 0. |
| 7 | RO | 1b | Core | Fast Back-to-Back (FB2B): Hardwired to 1. The IGD accepts fast back-to-back when the transactions are not to the same agent. |
| 6 | RO | 0b | Core | User Defined Format (UDF): Hardwired to 0. |
| 5 | RO | 0b | Core | 66 MHz PCI Capable (66C): N/A - Hardwired to 0. |
| 4 | RO | 1b | Core | Capability List (CLIST): This bit is set to 1 to indicate that the register at 34h provides an offset into the function's PCI Configuration Space containing a pointer to the location of the first item in the list. |
| 3 | RO | 0b | Core | Interrupt Status (INTSTS): This bit reflects the state of the interrupt in the device. Only when the Interrupt Disable bit in the command register is a 0 and this Interrupt Status bit is a 1, will the devices INTx# signal be asserted. |
| 2:0 | RO | 000b | Core | Reserved |



9.1.5 RID2—Revision Identification

B/D/F/Type: 0/2/0/PCI
 Address Offset: 8h
 Default Value: see description below
 Access: RO
 Size: 8 bits

This register contains the revision number for Device 2, Functions 0 and 1.

| Bit | Access | Default Value | RST/PWR | Description |
|-----|--------|-----------------|---------|------------------------------------------------------------------------------------------------------------------------------------------------------------------------------------------------------------------------------------------------------|
| 7:0 | RO | see description | Core | Revision Identification Number (RID): This is an 8-bit value that indicates the revision identification number for the GMCH Device 0. Refer to the <i>Intel® 4 Series Chipset Family Specification Update</i> for the value of this register. |

9.1.6 CC—Class Code

B/D/F/Type: 0/2/0/PCI
 Address Offset: 9-Bh
 Default Value: 030000h
 Access: RO
 Size: 24 bits

This register contains the device programming interface information related to the Sub-Class Code and Base Class Code definition for the IGD. This register also contains the Base Class Code and the function sub-class in relation to the Base Class Code.

| Bit | Access | Default Value | RST/PWR | Description |
|-------|--------|---------------|---------|-----------------------------------------------------------------------------------------------------------------------------------------------------------------------------------------------------------------------------------------------------------------------------------------------------------------------------------------------------------------------------|
| 23:16 | RO | 03h | Core | Base Class Code (BCC): This is an 8-bit value that indicates the base class code for the GMCH. This code has the value 03h, indicating a Display Controller. When MCHBAR offset 44h, bit 31 is 0 this code has the value 03h, indicating a Display Controller. When MCHBAR offset 44, bit 31 is 1 this code has the value 04h, indicating a Multimedia Device. |
| 15:8 | RO | 00h | Core | Sub-Class Code (SUBCC): When MCHBAR offset 44 bit 31 is 0 this value will be determined based on Device 0 GGC register, GMS and IVD fields. 00h = VGA compatible 80h = Non VGA (GMS = "0000" or IVD = "1") When MCHBAR offset 44 bit 31 is 1 this value is 80h, indicating other multimedia device. |
| 7:0 | RO | 00h | Core | Programming Interface (PI): When MCHBAR offset 44, bit 31 is 0 this value is 00h, indicating a Display Controller. When MCHBAR offset 44, bit 31 is 1 this value is 00h, indicating a NOP. |



9.1.7 CLS—Cache Line Size

B/D/F/Type: 0/2/0/PCI
 Address Offset: Ch
 Default Value: 00h
 Access: RO
 Size: 8 bits

The IGD does not support this register as a PCI slave.

| Bit | Access | Default Value | RST/PWR | Description |
|-----|--------|---------------|---------|----------------------------------------------------------------------------------------------------------------------------------------------------------------------------------------------------------------------------|
| 7:0 | RO | 00h | Core | Cache Line Size (CLS): This field is hardwired to 0s. The IGD as a PCI compliant master does not use the Memory Write and Invalidate command and, in general, does not perform operations based on cache line size. |

9.1.8 MLT2—Master Latency Timer

B/D/F/Type: 0/2/0/PCI
 Address Offset: Dh
 Default Value: 00h
 Access: RO
 Size: 8 bits

The IGD does not support the programmability of the master latency timer because it does not perform bursts.

| Bit | Access | Default Value | RST/PWR | Description |
|-----|--------|---------------|---------|-------------------------------------------------------------------|
| 7:0 | RO | 00h | Core | Master Latency Timer Count Value (MLTCV): Hardwired to 0s. |

9.1.9 HDR2—Header Type

B/D/F/Type: 0/2/0/PCI
 Address Offset: Eh
 Default Value: 80h
 Access: RO
 Size: 8 bits

This register contains the Header Type of the IGD.

| Bit | Access | Default Value | RST/PWR | Description |
|-----|--------|---------------|---------|-----------------------------------------------------------------------------------------------------------------------------------------------------------------------------------------------------------------------------------------|
| 7 | RO | 1b | Core | Multi Function Status (MFUNC): This bit indicates if the device is a Multi-Function Device. The Value of this register is determined by Device #0, offset 54h, DEVEN[4]. If Device 0 DEVEN[4] is set, the MFUNC bit is also set. |
| 6:0 | RO | 00h | Core | Header Code (H): This is a 7-bit value that indicates the Header Code for the IGD. This code has the value 00h, indicating a type 0 configuration space format. |



9.1.10 GTTMMADR—Graphics Translation Table, Memory Mapped Range Address

B/D/F/Type: 0/2/0/PCI
 Address Offset: 10-17h
 Default Value: 0000000000000004h
 Access: R/W, RO
 Size: 64 bits

This register requests allocation for combined Graphics Translation Table Modification Range and Memory Mapped Range. The space is 4 MB combined for MMIO and Global GTT table aperture (512 KB for MMIO and 2 MB for GTT). GTTADR will be at (GTTMMADR + 2 MB) while the MMIO base address will be the same as GTTMMADR.

For the Global GTT, this range is defined as a memory BAR in graphics device configuration space is an alias with which software is required to write values (PTEs) into and may also read values from the global Graphics Translation Table (GTT). PTEs cannot be written directly into the global GTT memory area.

The device snoops writes to this region in order to invalidate any cached translations within the various TLBs implemented on-chip. There are some exceptions to this.

The allocation is for 4 MB and the base address is defined by bits [35:22].

| Bit | Access | Default Value | RST/PWR | Description |
|-------|--------|---------------|-----------|------------------------------------------------------------------------------------------------------------------------------------------------------------------------------------------------------------|
| 63:36 | R/W | 0000000h | FLR, Core | (MBA) : This field must be set to 0 since addressing above 64 GB is not supported. |
| 35:22 | R/W | 0000h | FLR, Core | Memory Base Address (MBA) : This field is set by the OS, these bits correspond to address signals [35:22]. 4 MB combined for MMIO and Global GTT table aperture (512 KB for MMIO and 2 MB for GTT). |
| 21:4 | RO | 00000h | Core | Reserved : Hardwired to 0s to indicate at least 4 MB address range. |
| 3 | RO | 0b | Core | Prefetchable Memory (PREFMEM) : Hardwired to 0 to prevent prefetching. |
| 2:1 | RO | 10b | Core | Memory Type (MEMTYP) : 00 = Indicates 32 bit base address 01 = Reserved 10 = Indicates 64 bit base address 11 = Reserved |
| 0 | RO | 0b | Core | Memory/IO Space (MIOS) : Hardwired to 0 to indicate memory space. |



9.1.11 GMADR—Graphics Memory Range Address

B/D/F/Type: 0/2/0/PCI
 Address Offset: 18-1Fh
 Default Value: 0000000000000000Ch
 Access: R/W, RO, R/W/L
 Size: 64 bits

IGD graphics memory base address is specified in this register.

| Bit | Access | Default Value | RST/PWR | Description |
|-------|--------|---------------|-----------|---------------------------------------------------------------------------------------------------------------------------------------------------------------------------------------------------------------------------------|
| 63:36 | R/W | 0000000h | FLR, Core | Memory Base Address (MBA2): This field is set by the OS, these bits correspond to address signals 63:36. |
| 35:29 | R/W | 0000000b | FLR, Core | Memory Base Address (MBA): This field is set by the OS, these bits correspond to address signals 35:29. |
| 28 | R/W/L | 0b | FLR, Core | 512MB Address Mask (512ADMSK): This Bit is either part of the Memory Base Address (R/W) or part of the Address Mask (RO), depending on the value of MSAC[2:1]. See MSAC (Device 2, Function 0, offset 62h) for details. |
| 27 | R/W/L | 0b | FLR, Core | 256 MB Address Mask (256ADMSK): This bit is either part of the Memory Base Address (R/W) or part of the Address Mask (RO), depending on the value of MSAC[2:1]. See MSAC (Device 2, Function 0, offset 62h) for details. |
| 26:4 | RO | 000000h | Core | Address Mask (ADM): Hardwired to 0s to indicate at least 128 MB address range. |
| 3 | RO | 1b | Core | Prefetchable Memory (PREFMEM): Hardwired to 1 to enable prefetching. |
| 2:1 | RO | 10b | Core | Memory Type (MEMTYP): 00 = Indicates 32-bit address. 10 = Indicates 64-bit address |
| 0 | RO | 0b | Core | Memory/IO Space (MIOS): Hardwired to 0 to indicate memory space. |



9.1.12 IOBAR—I/O Base Address

B/D/F/Type: 0/2/0/PCI
 Address Offset: 20-23h
 Default Value: 00000001h
 Access: RO, R/W
 Size: 32 bits

This register provides the Base offset of the I/O registers within Device 2. Bits 15:3 are programmable allowing the I/O Base to be located anywhere in 16 bit I/O Address Space. Bits 2:1 are fixed and return zero, bit 0 is hardwired to a 1 indicating that 8 bytes of I/O space are decoded. Access to the 8Bs of I/O space is allowed in PM state D0 when IO Enable (PCICMD bit 0) set. Access is disallowed in PM states D1–D3 or if IO Enable is clear or if Device 2 is turned off or if internal graphics is disabled through the fuse or fuse override mechanisms.

Note that access to this IO BAR is independent of VGA functionality within Device 2. Also, note that this mechanism is available only through Function 0 of Device 2 and is not duplicated in Function 1.

If accesses to this IO bar is allowed then the GMCH claims all 8, 16, or 32 bit I/O cycles from the processor that falls within the 8B claimed.

| Bit | Access | Default Value | RST/PWR | Description |
|-------|--------|---------------|-----------|--------------------------------------------------------------------------------------------------------------|
| 31:16 | RO | 0000h | Core | Reserved |
| 15:3 | R/W | 0000h | FLR, Core | IO Base Address (IOBASE): This field is set by the OS, these bits correspond to address signals 15:3. |
| 2:1 | RO | 00b | Core | Memory Type (MEMTYPE): Hardwired to 0s to indicate 32-bit address. |
| 0 | RO | 1b | Core | Memory/IO Space (MIOS): Hardwired to 1 to indicate I/O space. |

9.1.13 SVID2—Subsystem Vendor Identification

B/D/F/Type: 0/2/0/PCI
 Address Offset: 2C-2Dh
 Default Value: 0000h
 Access: R/WO
 Size: 16 bits

| Bit | Access | Default Value | RST/PWR | Description |
|------|--------|---------------|---------|----------------------------------------------------------------------------------------------------------------------------------------------------------------------------------------------------------------------------------------------------------|
| 15:0 | R/WO | 0000h | Core | Subsystem Vendor ID (SUBVID): This value is used to identify the vendor of the subsystem. This register should be programmed by BIOS during boot-up. Once written, this register becomes Read Only. This register can only be cleared by a Reset. |

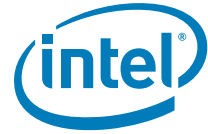

9.1.14 SID2—Subsystem Identification

B/D/F/Type: 0/2/0/PCI
 Address Offset: 2E-2Fh
 Default Value: 0000h
 Access: R/WO
 Size: 16 bits

| Bit | Access | Default Value | RST/PWR | Description |
|------|--------|---------------|---------|------------------------------------------------------------------------------------------------------------------------------------------------------------------------------------------------------------------------------------------------------|
| 15:0 | R/WO | 0000h | Core | Subsystem Identification (SUBID): This value is used to identify a particular subsystem. This field should be programmed by BIOS during boot-up. Once written, this register becomes Read Only. This register can only be cleared by a Reset. |

9.1.15 ROMADR—Video BIOS ROM Base Address

B/D/F/Type: 0/2/0/PCI
 Address Offset: 30-33h
 Default Value: 00000000h
 Access: RO
 Size: 32 bits

The IGD does not use a separate BIOS ROM, therefore this register is hardwired to 0s.

| Bit | Access | Default Value | RST/PWR | Description |
|-------|--------|---------------|---------|--------------------------------------------------------------------------------|
| 31:18 | RO | 0000h | Core | ROM Base Address (RBA): Hardwired to 0s. |
| 17:11 | RO | 00h | Core | Address Mask (ADMSK): Hardwired to 0s to indicate 256 KB address range. |
| 10:1 | RO | 000h | Core | Reserved: Hardwired to 0s. |
| 0 | RO | 0b | Core | ROM BIOS Enable (RBE): 0 = ROM not accessible. |

9.1.16 CAPPOINT—Capabilities Pointer

B/D/F/Type: 0/2/0/PCI
 Address Offset: 34h
 Default Value: 90h
 Access: RO
 Size: 8 bits

| Bit | Access | Default Value | RST/PWR | Description |
|-----|--------|---------------|---------|--------------------------------------------------------------------------------------------------------------------------------------------------------------------------------------------------------------------------------------------------------------------------------------------------------------------------------------|
| 7:0 | RO | 90h | Core | Capabilities Pointer Value (CPV): This field contains an offset into the function's PCI Configuration Space for the first item in the New Capabilities Linked List, the MSI Capabilities ID registers at address 90h, or the Power Management capability at D0h. This value is determined by the configuration in CAPL[0]. |



9.1.17 INTRLINE—Interrupt Line

B/D/F/Type: 0/2/0/PCI
Address Offset: 3Ch
Default Value: 00h
Access: R/W
Size: 8 bits

| Bit | Access | Default Value | RST/PWR | Description |
|-----|--------|---------------|---------|----------------------------------------------------------------------------------------------------------------------------------------------------------------------------------------------------------------------------------------------------------------------------------------------------------------------------------------------------------|
| 7:0 | R/W | 00h | Core | Interrupt Connection (INTCON): This field is used to communicate interrupt line routing information. POST software writes the routing information into this register as it initializes and configures the system. The value in this register indicates to which input of the system interrupt controller the device's interrupt pin is connected. |

9.1.18 INTRPIN—Interrupt Pin

B/D/F/Type: 0/2/0/PCI
Address Offset: 3Dh
Default Value: 01h
Access: RO
Size: 8 bits

| Bit | Access | Default Value | RST/PWR | Description |
|-----|--------|---------------|---------|--------------------------------------------------------------------------------------------------------------------------------|
| 7:0 | RO | 01h | Core | Interrupt Pin (INTRPIN): As a single function device, the IGD specifies INTA# as its interrupt pin. 01h = INTA#. |

9.1.19 MINGNT—Minimum Grant

B/D/F/Type: 0/2/0/PCI
Address Offset: 3Eh
Default Value: 00h
Access: RO
Size: 8 bits

| Bit | Access | Default Value | RST/PWR | Description |
|-----|--------|---------------|---------|-------------------------------------------------------------------------------------|
| 7:0 | RO | 00h | Core | Minimum Grant Value (MGV): The IGD does not burst as a PCI compliant master. |



9.1.20 MAXLAT—Maximum Latency

B/D/F/Type: 0/2/0/PCI
 Address Offset: 3Fh
 Default Value: 00h
 Access: RO
 Size: 8 bits

| Bit | Access | Default Value | RST/PWR | Description |
|-----|--------|---------------|---------|------------------------------------------------------------------------------------------------------------------------|
| 7:0 | RO | 00h | Core | Maximum Latency Value (MLV): The IGD has no specific requirements for how often it needs to access the PCI bus. |

9.1.21 CAPIDO—Capability Identifier

B/D/F/Type: 0/2/0/PCI
 Address Offset: 40-4Ch
 Default Value: 0000000000000000000010C0009h
 Access: RO
 Size: 104 bits
 BIOS Optimal Default 0h

This register control of bits in this register are only required for customer visible component differentiation.

| Bit | Access | Default Value | RST/PWR | Description |
|--------|--------|---------------|---------|----------------------------------------------------------------------------------------------------------------------------------------------------------------|
| 103:28 | RO | 0000b | Core | Reserved |
| 27:24 | RO | 1h | Core | CAPID Version (CAPIDV): This field has the value 0001b to identify the first revision of the CAPID register definition. |
| 23:16 | RO | 0Ch | Core | CAPID Length (CAPIDL): This field has the value 0Ch to indicate the structure length (12 bytes). |
| 15:8 | RO | 00h | Core | Next Capability Pointer (NCP): This field is hardwired to 00h indicating the end of the capabilities linked list. |
| 7:0 | RO | 09h | Core | Capability Identifier (CAP_ID): This field has the value 1001b to identify the CAP_ID assigned by the PCI SIG for vendor dependent capability pointers. |

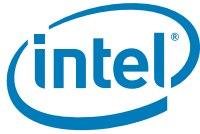

9.1.22 MGGC—GMCH Graphics Control Register

B/D/F/Type: 0/2/0/PCI
 Address Offset: 52-53h
 Default Value: 0030h
 Access: RO
 Size: 16 bits

Note: All the bits in this register are locked in Intel TXT mode (82Q45/82Q43 GMCH only).

| Bit | Access | Default Value | RST/PWR | Description |
|-------|--------|---------------|---------|------------------------------------------------------------------------------------------------------------------------------------------------------------------------------------------------------------------------------------------------------------------------------------------------------------------------------------------------------------------------------------------------------------------------------------------------------------------------------------------------------------------------------------------------------------------------------------------------------------------------------------------------------------------------------------------------------------------------------------------------------------------------------------------------------------------------------------------------------------------------------------------------------------------------------------------------------------------------------------------------------------------------------------------------------------------------------------------------------------------------------------------------------------------------------------------------------------------------------------------------------------------------------------------------------------------------------|
| 15:12 | RO | 0h | Core | Reserved |
| 11:8 | RO | 0h | Core | <p>GTT Graphics Memory Size (GGMS): This field is used to select the amount of Main Memory that is pre-allocated to support the Internal Graphics Translation Table. The BIOS ensures that memory is pre-allocated only when Internal graphics is enabled.</p> <p>GSM is assumed to be a contiguous physical DRAM space with DSM, and BIOS needs to allocate a contiguous memory chunk. Hardware will drive the base of GSM from DSM only using the GSM size programmed in the register.</p> <p>0000 = No memory pre-allocated. 0001 = No VT mode, 1 MB of memory pre-allocated for GTT. 0011 = No VT mode, 2 MB of memory pre-allocated for GTT 1001 = VT mode, 2 MB of memory pre-allocated for 1 MB of Global GTT and 1 MB for Shadow GTT (82Q45, 82Q43 GMCH only) 1010 = VT mode, 3 MB of memory pre-allocated for 1.5 MB of Global GTT and 1.5 MB for Shadow GTT (82Q45 GMCH only) 1011 = VT mode, 4 MB of memory pre-allocated for 2 MB of Global GTT and 2 MB for Shadow GTT (82Q45 GMCH only)</p> <p>NOTE: All unspecified encodings of this register field are reserved, hardware functionality is not assured if used. This register is locked and becomes Read Only when the D_LCK bit in the SMRAM register is set.</p> |

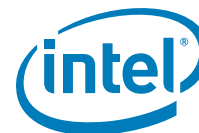

| Bit | Access | Default Value | RST/ PWR | Description |
|-----|--------|---------------|-------------|-------------------------------------------------------------------------------------------------------------------------------------------------------------------------------------------------------------------------------------------------------------------------------------------------------------------------------------------------------------------------------------------------------------------------------------------------------------------------------------------------------------------------------------------------------------------------------------------------------------------------------------------------------------------------------------------------------------------------------------------------------------------------------------------------------------------------------------------------------------------------------------------------------------------------------------------------------------------------------------------------------------------------------------------------------------------------------------------------------------------------------------------------------------------------------------------------------------------------------------------------------------------------------------------------------------------------------------------------------------------------------------------------------------------------------------------------------------------------------------------------------------------------------------------------------------------------------------------------------------------------------------|
| 7:4 | RO | 0011b | Core | <p>Graphics Mode Select (GMS): This field is used to select the amount of Main Memory that is pre-allocated to support the Internal Graphics device in VGA (non-linear) and Native (linear) modes. The BIOS ensures that memory is pre-allocated only when Internal graphics is enabled.</p> <p>0000 = No memory pre-allocated. Device 2 (IGD) does not claim VGA cycles (Memory and I/O), and the Sub-Class Code field within Device 2, Function 0 Class Code register is 80h.</p> <p>0001 = Reserved</p> <p>0010 =Reserved</p> <p>0011 =Reserved</p> <p>0100 =Reserved</p> <p>0101 =DVMT (UMA) mode, 32 MB of memory pre-allocated for frame buffer.</p> <p>0110 =DVMT (UMA) mode, 48 MB of memory pre-allocated for frame buffer.</p> <p>0111 =DVMT (UMA) mode, 64 MB of memory pre-allocated for frame buffer.</p> <p>1000 =DVMT (UMA) mode, 128 MB of memory pre-allocated for frame buffer.</p> <p>1001 =DVMT (UMA) mode, 256 MB of memory pre-allocated for frame buffer.</p> <p>1010 =DVMT (UMA) mode, 96 MB of memory pre-allocated (0 + 96).</p> <p>1011 =DVMT (UMA) mode, 160 MB of memory pre-allocated (64 + 96).</p> <p>1100 =DVMT (UMA) mode, 224 MB of memory pre-allocated (128 + 96).</p> <p>1101 =DVMT (UMA) mode, 352 MB of memory pre-allocated (256 + 96).</p> <p>NOTE: This register is locked and becomes Read Only when the D_LCK bit in the SMRAM register is set.</p> <p>Hardware does not clear or set any of these bits automatically based on IGD being disabled/enabled.</p> <p>BIOS Requirement: BIOS must not set this field to 000 if IVD (bit 1 of this register) is 0.</p> |
| 3:2 | RO | 00b | Core | Reserved |
| 1 | RO | 0b | Core | <p>IGD VGA Disable (IVD):</p> <p>0 = Enable. Device 2 (IGD) claims VGA memory and I/O cycles, the Sub-Class Code within Device 2 Class Code register is 00h.</p> <p>1 = Disable. Device 2 (IGD) does not claim VGA cycles (Memory and I/O), and the Sub- Class Code field within Device 2 function 0 Class Code register is 80h.</p> <p>BIOS Requirement: BIOS must not set this bit to 0 if the GMS field (bits 6:4 of this register) pre-allocates no memory. This bit MUST be set to 1 if Device 2 is disabled either via a fuse or fuse override (CAPID0[38] = 1) or via a register (DEVEN[3] = 0).</p> |
| 0 | RO | 0b | Core | Reserved |



9.1.23 DEVEN—Device Enable

B/D/F/Type: 0/2/0/PCI
 Address Offset: 54-57h
 Default Value: 000023DBh
 Access: RO
 Size: 32 bits

This register allows for enabling/disabling of PCI devices and functions that are within the GMCH.

Note: All the bits in this register are locked in Intel TXT mode (82Q45/82Q43 GMCH only).

| Bit | Access | Default Value | RST/PWR | Description |
|-------|--------|---------------|---------|----------------------------------------------------------------------------------------------------------------------------------------------------------------------------------------------------------------------------------------------------------------------------------------------------------|
| 31:15 | RO | 00000h | Core | Reserved |
| 14 | RO | 0b | Core | Reserved |
| 13 | RO | 1b | Core | Reserved |
| 12:11 | RO | 00b | Core | Reserved (DEVEN): |
| 10 | RO | 0b | Core | Reserved (D3F4EN): |
| 9 | RO | 1b | Core | EP Function 3 (D3F3EN): 0 = Bus 0, Device 3, Function 3 is disabled and hidden 1 = Bus 0, Device 3, Function 3 is enabled and visible If Device 3, Function 0 is disabled and hidden, then Device 3, Function 3 is also disabled and hidden independent of the state of this bit. |
| 8 | RO | 1b | Core | EP Function 2 (D3F2EN): 0 = Bus 0, Device 3, Function 2 is disabled and hidden 1 = Bus 0, Device 3, Function 2 is enabled and visible If Device 3, Function 0 is disabled and hidden, then Device 3, Function 2 is also disabled and hidden independent of the state of this bit. |
| 7 | RO | 1b | Core | EP Function 1 (D3F1EN): 0 = Bus 0, Device 3, Function 1 is disabled and hidden 1 = Bus 0, Device 3, Function 1 is enabled and visible. If this GMCH does not have ME capability (CAPIDO[??] = 1), then Device 3, Function 1 is disabled and hidden independent of the state of this bit. |
| 6 | RO | 1b | Core | EP Function 0 (D3F0EN): 0 = Bus 0, Device 3, Function 0 is disabled and hidden 1 = Bus 0, Device 3, Function 0 is enabled and visible. If this GMCH does not have ME capability (CAPIDO[??] = 1) then Device 3, Function 0 is disabled and hidden independent of the state of this bit. |
| 5 | RO | 0b | Core | Reserved |



| Bit | Access | Default Value | RST/ PWR | Description |
|-----|--------|---------------|-------------|-----------------------------------------------------------------------------------------------------------------------------------------------------------------------------------------------------------------------------------------------------------------------------------------------------------------------------------------------------------------------------------------------------------------------------------------------------------------------------------------------------------------------------------------------------------------------------------------|
| 4 | RO | 1b | Core | <p>Internal Graphics Engine Function 1 (D2F1EN): 0 = Bus 0, Device 2, Function 1 is disabled and hidden 1 = Bus 0, Device 2, Function 1 is enabled and visible If Device 2, Function 0 is disabled and hidden, then Device 2, Function 1 is also disabled and hidden independent of the state of this bit. If this component is not capable of Dual Independent Display (CAPID0[78] = 1), then this bit is hardwired to 0b to hide Device 2, Function 1.</p> |
| 3 | RO | 1b | Core | <p>Internal Graphics Engine Function 0 (D2FOEN): 0 = Bus 0, Device 2, Function 0 is disabled and hidden 1 = Bus 0, Device 2, Function 0 is enabled and visible If this GMCH does not have internal graphics capability (CAPID0[46] = 1), then Device 2, Function 0 is disabled and hidden independent of the state of this bit.</p> |
| 2 | RO | 0b | Core | Reserved |
| 1 | RO | 1b | Core | <p>PCI Express Port (D1EN): 0 = Bus 0, Device 1, Function 0 is disabled and hidden. 1 = Bus 0, Device 1, Function 0 is enabled and visible. Default value is determined by the device capabilities (see CAPID0[44]), SDVO Presence hardware strap and the sDVO/PCIe Concurrent hardware strap. Device 1 is Disabled on Reset if the SDVO Presence strap was sampled high, and the sDVO/PCIe Concurrent strap was sampled low at the last assertion of PWROK, and is enabled by default otherwise.</p> |
| 0 | RO | 1b | Core | <p>Host Bridge (DOEN): Bus 0, Device 0, Function 0 may not be disabled and is therefore hardwired to 1.</p> |



9.1.24 SSRW—Software Scratch Read Write

B/D/F/Type: 0/2/0/PCI
 Address Offset: 58-5Bh
 Default Value: 00000000h
 Access: R/W
 Size: 32 bits

| Bit | Access | Default Value | RST/PWR | Description |
|------|--------|---------------|-----------|-------------|
| 31:0 | R/W | 00000000h | FLR, Core | Reserved |

9.1.25 BSM—Base of Stolen Memory

B/D/F/Type: 0/2/0/PCI
 Address Offset: 5C-5Fh
 Default Value: 07800000h
 Access: RO
 Size: 32 bits

Graphics Stolen Memory and TSEG are within DRAM space defined under TOLUD. From the top of low used DRAM, GMCH claims 1 to 64 MB of DRAM for internal graphics if enabled.

The base of stolen memory will always be below 4 GB. This is required to prevent aliasing between stolen range and the reclaim region.

| Bit | Access | Default Value | RST/PWR | Description |
|-------|--------|---------------|---------|---------------------------------------------------------------------------------------------------------------------------------------------------------------------------------------------------------------------------------------------------------------------------------------|
| 31:20 | RO | 078h | Core | Base of Stolen Memory (BSM): This register contains bits 31:20 of the base address of stolen DRAM memory. The host interface determines the base of Graphics Stolen memory by subtracting the graphics stolen memory size from TOLUD. See Device 0 TOLUD for more explanation. |
| 19:0 | RO | 00000h | Core | Reserved |

9.1.26 HSRW—Hardware Scratch Read Write

B/D/F/Type: 0/2/0/PCI
 Address Offset: 60-61h
 Default Value: 0000h
 Access: R/W
 Size: 16 bits

| Bit | Access | Default Value | RST/PWR | Description |
|------|--------|---------------|-----------|-------------|
| 15:0 | R/W | 0000h | FLR, Core | Reserved |



9.1.27 MC—Message Control

B/D/F/Type: 0/2/0/PCI
 Address Offset: 92-93h
 Default Value: 0000h
 Access: RO, R/W
 Size: 16 bits

System software can modify bits in this register, but the device is prohibited from doing so. If the device writes the same message multiple times, only one of those messages is serviced. If all of them must be serviced, the device must not generate the same message again until the driver services the earlier one.

| Bit | Access | Default Value | RST/PWR | Description |
|------|--------|---------------|-----------|---------------------------------------------------------------------------------------------------------------------------------------------------------------------------------------------------------------------------------------------------------------------------------------------------------------------------|
| 15:8 | RO | 00h | Core | Reserved |
| 7 | RO | 0b | Core | 64 Bit Capable (64BCAP): Hardwired to 0 to indicate that the function does not implement the upper 32 bits of the Message address register and is incapable of generating a 64-bit memory address. This may need to change in future implementations when addressable system memory exceeds the 32b/4 GB limit. |
| 6:4 | R/W | 000b | FLR, Core | Multiple Message Enable (MME): System software programs this field to indicate the actual number of messages allocated to this device. This number will be equal to or less than the number actually requested. The encoding is the same as for the MMC field below. |
| 3:1 | RO | 000b | Core | Multiple Message Capable (MMC): System Software reads this field to determine the number of messages being requested by this device. 000 = 1 All other encodings are reserved. |
| 0 | R/W | 0b | FLR, Core | MSI Enable (MSIEN): This bit controls the ability of this device to generate MSIs. |

9.1.28 MA—Message Address

B/D/F/Type: 0/2/0/PCI
 Address Offset: 94-97h
 Default Value: 00000000h
 Access: R/W, RO
 Size: 32 bits

| Bit | Access | Default Value | RST/PWR | Description |
|------|--------|---------------|-----------|--------------------------------------------------------------------------------------------------------------------------------------------------------------------------------------------------------------|
| 31:2 | R/W | 00000000h | FLR, Core | Message Address (MESSADD): This field is used by system software to assign an MSI address to the device. The device handles an MSI by writing the padded contents of the MD register to this address. |
| 1:0 | RO | 00b | Core | Force DWord Align (FDWORD): Hardwired to 0 so that addresses assigned by system software are always aligned on a DWord address boundary. |



9.1.29 MD—Message Data

B/D/F/Type: 0/2/0/PCI
 Address Offset: 98-99h
 Default Value: 0000h
 Access: R/W
 Size: 16 bits

| Bit | Access | Default Value | RST/PWR | Description |
|------|--------|---------------|-----------|-------------------------------------------------------------------------------------------------------------------------------------------------------------------------------------------------------------------------------------------------------------------------------------------------------------------------------------------------------------------------------------|
| 15:0 | R/W | 0000h | FLR, Core | <p>Message Data (MESSDATA): This is the base message data pattern assigned by system software and used to handle an MSI from the device.</p> <p>When the device must generate an interrupt request, it writes a 32-bit value to the memory address specified in the MA register. The upper 16 bits are always set to 0. The lower 16 bits are supplied by this register.</p> |

9.1.30 GDRST—Graphics Debug Reset

B/D/F/Type: 0/2/0/PCI
 Address Offset: C0h
 Default Value: 00h
 Access: RO, R/W/SC, R/W
 Size: 8 bits

| Bit | Access | Default Value | RST/PWR | Description |
|-----|--------|---------------|-----------|---------------------------------------------------------------------------------------------------------------------------------------------------------------------------------------------------------------------------------------------------------------------------------------------------------------------------------------------------------------------------------------------------------------------------------------------------------------------------------------------------------------------------------------------------------------------------------------------------------------------------------------------------------------------------------------------------------------------------------------------------------------------------------------------------------------------------------------------------------------------------------------------------------------------------------------------------|
| 7:4 | RO | 0h | FLR, Core | Reserved |
| 3:2 | R/W | 00b | FLR, Core | <p>Graphics Reset Domain (GRDOM):</p> <p>00 = Full Graphics Reset will be performed (both render and display clock domain resets asserted)</p> <p>01 = Render Only Reset (render clock domain reset asserted)</p> <p>10 = Reserved (invalid Programming)</p> <p>11 = Media Only Reset (Media domain reset get asserted)</p> |
| 1 | RO | 0b | FLR, Core | Reserved |
| 0 | R/W/SC | 0b | FLR, Core | <p>Graphics Reset Enable (GR): Setting this bit asserts graphics-only reset. The clock domains to be reset are determined by GRDOM. Hardware resets this bit when the reset is complete. Setting this bit without waiting for it to clear, is undefined behavior.</p> <p>Once this bit is set to a 1, all GFX core MMIO registers are returned to power on default state. All Ring buffer pointers are reset, command stream fetches are dropped and ongoing render pipeline processing is halted, state machines and State Variables returned to power on default state. If the Display is reset, all display engines are halted (garbage on screen). VGA memory is not available, Store DWords and interrupts are not ensured to be completed. Device 2 I/O registers are not available.</p> <p>Device 2 Configuration registers continue to be available while Graphics reset is asserted.</p> <p>This bit is hardwired auto-clear.</p> |



9.1.31 PMCAPID—Power Management Capabilities ID

B/D/F/Type: 0/2/0/PCI
 Address Offset: D0-D1h
 Default Value: 0001h
 Access: R/WO, RO
 Size: 16 bits

| Bit | Access | Default Value | RST/PWR | Description |
|------|--------|---------------|---------|-------------------------------------------------------------------------------------------------------------------------------------------------------------------------------------------------|
| 15:8 | R/WO | 00h | Core | Next Capability Pointer (NEXT_PTR): This field contains a pointer to the next item in the capabilities list. BIOS is responsible for writing this to the FLR Capability when applicable. |
| 7:0 | RO | 01h | Core | Capability Identifier (CAP_ID): SIG defines this ID is 01h for power management. |

9.1.32 PMCAP—Power Management Capabilities

B/D/F/Type: 0/2/0/PCI
 Address Offset: D2-D3h
 Default Value: 0022h
 Access: RO
 Size: 16 bits

This register is a Mirror of Function 0 with the same read/write attributes. The hardware implements a single physical register common to both Functions 0 and 1.

| Bit | Access | Default Value | RST/PWR | Description |
|-------|--------|---------------|---------|---------------------------------------------------------------------------------------------------------------------------------------------------------------------------------------------------------------------------------|
| 15:11 | RO | 00h | Core | PME Support (PMES): This field indicates the power states in which the IGD may assert PME#. Hardwired to 0 to indicate that the IGD does not assert the PME# signal. |
| 10 | RO | 0b | Core | D2 Support (D2): The D2 power management state is not supported. This bit is hardwired to 0. |
| 9 | RO | 0b | Core | D1 Support (D1): Hardwired to 0 to indicate that the D1 power management state is not supported. |
| 8:6 | RO | 000b | Core | Reserved |
| 5 | RO | 1b | Core | Device Specific Initialization (DSI): Hardwired to 1 to indicate that special initialization of the IGD is required before generic class device driver is to use it. |
| 4 | RO | 0b | Core | Reserved |
| 3 | RO | 0b | Core | PME Clock (PMECLK): Hardwired to 0 to indicate IGD does not support PME# generation. |
| 2:0 | RO | 010b | Core | Version (VER): Hardwired to 010b to indicate that there are 4 bytes of power management registers implemented and that this device complies with the <i>PCI Power Management Interface Specification, Revision 1.1</i> . |



9.1.33 PMCS—Power Management Control/Status

B/D/F/Type: 0/2/0/PCI
 Address Offset: D4-D5h
 Default Value: 0000h
 Access: RO, R/W
 Size: 16 bits

| Bit | Access | Default Value | RST/PWR | Description |
|-------|--------|---------------|-----------|------------------------------------------------------------------------------------------------------------------------------------------------------------------------------------------------------------------------------------------------------------------------------------------------------------------------------------------------------------------------------------------------------------------------------------------------------------------------------------------------------------|
| 15 | RO | 0b | Core | PME Status (PMESTS): This bit is 0 to indicate that IGD does not support PME# generation from D3 (cold). |
| 14:13 | RO | 00b | Core | Data Scale (DSCALE): The IGD does not support data register. This bit always returns 00 when read, write operations have no effect. |
| 12:9 | RO | 0h | Core | Data Select (DSEL): The IGD does not support data register. This bit always returns 0h when read, write operations have no effect. |
| 8 | RO | 0b | Core | PME Enable (PME_EN): This bit is 0 to indicate that PME# assertion from D3 (cold) is disabled. |
| 7:2 | RO | 00h | Core | Reserved |
| 1:0 | R/W | 00b | FLR, Core | Power State (PWRSTAT): This field indicates the current power state of the IGD and can be used to set the IGD into a new power state. If software attempts to write an unsupported state to this field, write operation must complete normally on the bus, but the data is discarded and no state change occurs. On a transition from D3 to D0 the graphics controller is optionally reset to initial values. 00 = D0 (Default) 01 = D1 (Not Supported) 10 = D2 (Not Supported) 11 = D3 |

9.1.34 SWSMI—Software SMI

B/D/F/Type: 0/2/0/PCI
 Address Offset: E0-E1h
 Default Value: 0000h
 Access: R/W
 Size: 16 bits

As long as there is the potential that DVO port legacy drivers exist which expect this register at this address, Device 2, Function 0 address E0h–E1h must be reserved for this register.

| Bit | Access | Default Value | RST/PWR | Description |
|------|--------|---------------|---------|-----------------------------------------------------------------------------------------------------------------------------|
| 15:8 | R/W | 00h | Core | Software Scratch Bits (SWSB): |
| 7:1 | R/W | 00h | Core | Software Flag (SWF): This field is used to indicate caller and SMI function desired, as well as return result. |
| 0 | R/W | 0b | Core | GMCH Software SMI Event (GSSMIE): When set, this bit will trigger an SMI. Software must write a 0 to clear this bit. |



9.2 Integrated Graphics Registers (D2:F1)

Table 16. PCI Register Address Map (D2:F1)

| Address Offset | Register Symbol | Register Name | Default Value | Access |
|----------------|-----------------|-----------------------------------------------------------|-------------------------------------|----------|
| 0–1h | VID2 | Vendor Identification | 8086h | RO |
| 2–3h | DID2 | Device Identification | see register description | RO |
| 4–5h | PCICMD2 | PCI Command | 0000h | RO, R/W |
| 6–7h | PCISTS2 | PCI Status | 0090h | RO |
| 8h | RID2 | Revision Identification | see register description | RO |
| 9–Bh | CC | Class Code Register | 038000h | RO |
| Ch | CLS | Cache Line Size | 00h | RO |
| Dh | MLT2 | Master Latency Timer | 00h | RO |
| Eh | HDR2 | Header Type | 80h | RO |
| 10–17h | MMADR | Memory Mapped Range Address | 0000000000 000004h | R/W, RO |
| 2C–2Dh | SVID2 | Subsystem Vendor Identification | 0000h | RO |
| 2E–2Fh | SID2 | Subsystem Identification | 0000h | RO |
| 30–33h | ROMADR | Video BIOS ROM Base Address | 00000000h | RO |
| 34h | CAPPOINT | Capabilities Pointer | D0h | RO |
| 3Eh | MINGNT | Minimum Grant | 00h | RO |
| 3Fh | MAXLAT | Maximum Latency | 00h | RO |
| 40–4Ch | CAPID0 | Mirror of Dev0 Capability Identifier | 0000000000 0000000001 0C0009h | RO |
| 52–53h | MGGC | Mirror of Device 0 GMCH Graphics Control Register | 0030h | RO |
| 54–57h | DEVEN | Device Enable | 000023DBh | RO |
| 58–5Bh | SSRW | Mirror of Function 0 Software Scratch Read Write | 00000000h | RO |
| 5C–5Fh | BSM | Mirror of Function 0 Base of Stolen Memory | 07800000h | RO |
| 60–61h | HSRW | Mirror of Device 2 Function 0 Hardware Scratch Read Write | 0000h | RO |
| C0h | GDRST | Mirror of Device 2 Function 0 Graphics Reset | 00h | RO |
| D0–D1h | PMCAPID | Mirror of Function 0 Power Management Capabilities ID | 0001h | R/WO, RO |
| D2–D3h | PMCAP | Mirror of Function 0 Power Management Capabilities | 0022h | RO |
| D4–D5h | PMCS | Power Management Control/Status | 0000h | RO, R/W |
| D8–DBh | — | Reserved | 00000000h | RO |
| E0–E1h | SWSMI | Mirror of Func0 Software SMI | 0000h | RO |



9.2.1 VID2—Vendor Identification

B/D/F/Type: 0/2/1/PCI
Address Offset: 0-1h
Default Value: 8086h
Access: RO
Size: 16 bits

This register combined with the Device Identification register uniquely identifies any PCI device.

| Bit | Access | Default Value | RST/PWR | Description |
|------|--------|---------------|---------|-----------------------------------------------------------------------------------|
| 15:0 | RO | 8086h | Core | Vendor Identification Number (VID): PCI standard identification for Intel. |

9.2.2 DID2—Device Identification

B/D/F/Type: 0/2/1/PCI
Address Offset: 2-3h
Default Value: see description below
Access: RO
Size: 16 bits

This register is unique in Function 1 (the Function 0 DID is separate). This difference in Device ID is necessary for allowing distinct Plug and Play enumeration of function 1 when both function 0 and function 1 have the same class code.

| Bit | Access | Default Value | RST/PWR | Description |
|------|--------|-----------------|---------|----------------------------------------------------------------------------------------------------------------------------------------------------------------------------------------------------------|
| 15:0 | RO | see description | Core | Device Identification Number (DID): Identifier assigned to the GMCH core/primary PCI device. Refer to the <i>Intel® 4 Series Chipset Family Specification Update</i> for values in this register. |

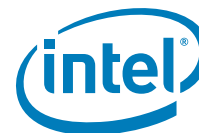

9.2.3 PCICMD2—PCI Command

B/D/F/Type: 0/2/1/PCI
 Address Offset: 4-5h
 Default Value: 0000h
 Access: RO, R/W
 Size: 16 bits

This 16-bit register provides basic control over the IGD's ability to respond to PCI cycles. The PCICMD Register in the IGD disables the IGD PCI compliant master accesses to main memory.

| Bit | Access | Default Value | RST/PWR | Description |
|-------|--------|---------------|-----------|-------------------------------------------------------------------------------------------------------------------------------------------------------------------------------------------------------------------------------------------------------------------------------------|
| 15:10 | RO | 00h | Core | Reserved |
| 9 | RO | 0b | Core | Fast Back-to-Back (FB2B): Not Implemented. Hardwired to 0. |
| 8 | RO | 0b | Core | SERR Enable (SERRE): Not Implemented. Hardwired to 0. |
| 7 | RO | 0b | Core | Address/Data Stepping Enable (ADSTEP): Not Implemented. Hardwired to 0. |
| 6 | RO | 0b | Core | Parity Error Enable (PERRE): Not Implemented. Hardwired to 0. Since the IGD belongs to the category of devices that does not corrupt programs or data in system memory or hard drives, the IGD ignores any parity error that it detects and continues with normal operation. |
| 5 | RO | 0b | Core | VGA Palette Snoop Enable (VGASNOOP): This bit is hardwired to 0 to disable snooping. |
| 4 | RO | 0b | Core | Memory Write and Invalidate Enable (MWIE): Hardwired to 0. The IGD does not support memory write and invalidate commands. |
| 3 | RO | 0b | Core | Special Cycle Enable (SCE): This bit is hardwired to 0. The IGD ignores Special cycles. |
| 2 | R/W | 0b | FLR, Core | Bus Master Enable (BME): 0 = Disable IGD bus mastering. 1 = Enable the IGD to function as a PCI compliant master. |
| 1 | R/W | 0b | FLR, Core | Memory Access Enable (MAE): This bit controls the IGD's response to memory space accesses. 0 = Disable. 1 = Enable. |
| 0 | R/W | 0b | FLR, Core | I/O Access Enable (IOAE): This bit controls the IGD's response to I/O space accesses. 0 = Disable. 1 = Enable. |



9.2.4 PCISTS2—PCI Status

B/D/F/Type: 0/2/1/PCI
 Address Offset: 6-7h
 Default Value: 0090h
 Access: RO
 Size: 16 bits

PCISTS is a 16-bit status register that reports the occurrence of a PCI compliant master abort and PCI compliant target abort. PCISTS also indicates the DEVSEL# timing that has been set by the IGD.

| Bit | Access | Default Value | RST/PWR | Description |
|------|--------|---------------|---------|------------------------------------------------------------------------------------------------------------------------------------------------------------------------------------------------------------------------------|
| 15 | RO | 0b | Core | Detected Parity Error (DPE): Since the IGD does not detect parity, this bit is always hardwired to 0. |
| 14 | RO | 0b | Core | Signaled System Error (SSE): The IGD never asserts SERR#, therefore this bit is hardwired to 0. |
| 13 | RO | 0b | Core | Received Master Abort Status (RMAS): The IGD never gets a Master Abort, therefore this bit is hardwired to 0. |
| 12 | RO | 0b | Core | Received Target Abort Status (RTAS): The IGD never gets a Target Abort, therefore this bit is hardwired to 0. |
| 11 | RO | 0b | Core | Signaled Target Abort Status (STAS): Hardwired to 0. The IGD does not use target abort semantics. |
| 10:9 | RO | 00b | Core | DEVSEL Timing (DEVT): N/A. These bits are hardwired to "00". |
| 8 | RO | 0b | Core | Master Data Parity Error Detected (DPD): Since Parity Error Response is hardwired to disabled (and the IGD does not do any parity detection), this bit is hardwired to 0. |
| 7 | RO | 1b | Core | Fast Back-to-Back (FB2B): Hardwired to 1. The IGD accepts fast back-to-back when the transactions are not to the same agent. |
| 6 | RO | 0b | Core | User Defined Format (UDF): Hardwired to 0. |
| 5 | RO | 0b | Core | 66 MHz PCI Capable (66C): N/A - Hardwired to 0. |
| 4 | RO | 1b | Core | Capability List (CLIST): This bit is set to 1 to indicate that the register at 34h provides an offset into the function's PCI Configuration Space containing a pointer to the location of the first item in the list. |
| 3 | RO | 0b | Core | Interrupt Status (INTSTS): Hardwired to 0. |
| 2:0 | RO | 000b | Core | Reserved |



9.2.5 RID2—Revision Identification

B/D/F/Type: 0/2/1/PCI
 Address Offset: 8h
 Default Value: see description below
 Access: RO
 Size: 8 bits

This register contains the revision number for Device #2 Functions 0 and 1

| Bit | Access | Default Value | RST/PWR | Description |
|-----|--------|-----------------|---------|------------------------------------------------------------------------------------------------------------------------------------------------------------------------------------------------------------------------------------------------------|
| 7:0 | RO | see description | Core | Revision Identification Number (RID): This is an 8-bit value that indicates the revision identification number for the GMCH Device 0. Refer to the <i>Intel® 4 Series Chipset Family Specification Update</i> for the value of this register. |

9.2.6 CC—Class Code Register

B/D/F/Type: 0/2/1/PCI
 Address Offset: 9-Bh
 Default Value: 038000h
 Access: RO
 Size: 24 bits

This register contains the device programming interface information related to the Sub-Class Code and Base Class Code definition for the IGD. This register also contains the Base Class Code and the function sub-class in relation to the Base Class Code.

| Bit | Access | Default Value | RST/PWR | Description |
|-------|--------|---------------|---------|------------------------------------------------------------------------------------------------------------------------------------------------------------------------------------------------------------------------------------------------------------------------------------------------------------------------------------------------------------------------------|
| 23:16 | RO | 03h | Core | Base Class Code (BCC): This is an 8-bit value that indicates the base class code for the GMCH. This code has the value 03h, indicating a Display Controller. When MCHBAR offset 44h, bit 31 is 0 this code has the value 03h, indicating a Display Controller. When MCHBAR offset 44h, bit 31 is 1 this code has the value 04h, indicating a Multimedia Device. |
| 15:8 | RO | 80h | Core | Sub-Class Code (SUBCC): When MCHBAR offset 44, bit 31 is 0 this value 80h, indicating Non VGA. When MCHBAR offset 44h, bit 31 is 1 this value is 80h, indicating other multimedia device. |
| 7:0 | RO | 00h | Core | Programming Interface (PI): When MCHBAR offset 44h, bit 31 is 0 this value is 00h, indicating a Display Controller. When MCHBAR offset 44h, bit 31 is 1 this value is 00h, indicating a NOP. |



9.2.7 CLS—Cache Line Size

B/D/F/Type: 0/2/1/PCI
Address Offset: Ch
Default Value: 00h
Access: RO
Size: 8 bits

The IGD does not support this register as a PCI slave.

| Bit | Access | Default Value | RST/PWR | Description |
|-----|--------|---------------|---------|----------------------------------------------------------------------------------------------------------------------------------------------------------------------------------------------------------------------------|
| 7:0 | RO | 00h | Core | Cache Line Size (CLS): This field is hardwired to 0s. The IGD as a PCI compliant master does not use the Memory Write and Invalidate command and, in general, does not perform operations based on cache line size. |

9.2.8 MLT2—Master Latency Timer

B/D/F/Type: 0/2/1/PCI
Address Offset: Dh
Default Value: 00h
Access: RO
Size: 8 bits

The IGD does not support the programmability of the master latency timer because it does not perform bursts.

| Bit | Access | Default Value | RST/PWR | Description |
|-----|--------|---------------|---------|-------------------------------------------------------------------|
| 7:0 | RO | 00h | Core | Master Latency Timer Count Value (MLTCV): Hardwired to 0s. |

9.2.9 HDR2—Header Type

B/D/F/Type: 0/2/1/PCI
Address Offset: Eh
Default Value: 80h
Access: RO
Size: 8 bits

This register contains the Header Type of the IGD.

| Bit | Access | Default Value | RST/PWR | Description |
|-----|--------|---------------|---------|----------------------------------------------------------------------------------------------------------------------------------------------------------------------------------------------------------------------------------------|
| 7 | RO | 1b | Core | Multi Function Status (MFUNC): This bit indicates if the device is a Multi-Function Device. The Value of this register is determined by Device 0, offset 54h, DEVEN[4]. If Device 0 DEVEN[4] is set, the MFUNC bit is also set. |
| 6:0 | RO | 00h | Core | Header Code (H): This is an 7-bit value that indicates the Header Code for the IGD. This code has the value 00h, indicating a type 0 configuration space format. |



9.2.10 MMADR—Memory Mapped Range Address

B/D/F/Type: 0/2/1/PCI
 Address Offset: 10-17h
 Default Value: 0000000000000004h
 Access: R/W, RO
 Size: 64 bits

This register requests allocation for the IGD registers and instruction ports. The allocation is for 512 KB and the base address is defined by bits [31: 19].

| Bit | Access | Default Value | RST/PWR | Description |
|-------|--------|---------------|-----------|------------------------------------------------------------------------------------------------------------|
| 63:36 | R/W | 0000000h | FLR, Core | Reserved |
| 35:20 | R/W | 0000h | FLR, Core | Memory Base Address (MBA) : Set by the OS, these bits correspond to address signals 35:20. |
| 19:4 | RO | 0000h | Core | Address Mask (ADMSK) : Hardwired to 0s to indicate 512 KB address range (aligned to 1 MB boundary). |
| 3 | RO | 0b | Core | Prefetchable Memory (PREFMEM) : Hardwired to 0 to prevent prefetching. |
| 2:1 | RO | 10b | Core | Memory Type (MEMTYP) : Hardwired to 10b to indicate 64-bit address. |
| 0 | RO | 0b | Core | Memory / IO Space (MIOS) : Hardwired to 0 to indicate memory space. |

9.2.11 SVID2—Subsystem Vendor Identification

B/D/F/Type: 0/2/1/PCI
 Address Offset: 2C-2Dh
 Default Value: 0000h
 Access: RO
 Size: 16 bits

| Bit | Access | Default Value | RST/PWR | Description |
|------|--------|---------------|---------|--------------------------------------------------------------------------------------------------------------------------------------------------------------------------------------------------------------------------------------------------------------|
| 15:0 | RO | 0000h | Core | Subsystem Vendor ID (SUBVID) : This value is used to identify the vendor of the subsystem. This register should be programmed by BIOS during boot-up. Once written, this register becomes Read Only. This register can only be cleared by a Reset. |



9.2.12 SID2—Subsystem Identification

B/D/F/Type: 0/2/1/PCI
 Address Offset: 2E-2Fh
 Default Value: 0000h
 Access: RO
 Size: 16 bits

| Bit | Access | Default Value | RST/PWR | Description |
|------|--------|---------------|---------|------------------------------------------------------------------------------------------------------------------------------------------------------------------------------------------------------------------------------------------------------|
| 15:0 | RO | 0000h | Core | Subsystem Identification (SUBID): This value is used to identify a particular subsystem. This field should be programmed by BIOS during boot-up. Once written, this register becomes Read Only. This register can only be cleared by a Reset. |

9.2.13 ROMADR—Video BIOS ROM Base Address

B/D/F/Type: 0/2/1/PCI
 Address Offset: 30-33h
 Default Value: 00000000h
 Access: RO
 Size: 32 bits

The IGD does not use a separate BIOS ROM, therefore this register is hardwired to 0s.

| Bit | Access | Default Value | RST/PWR | Description |
|-------|--------|---------------|---------|--------------------------------------------------------------------------------|
| 31:18 | RO | 0000h | Core | ROM Base Address (RBA): Hardwired to 0s. |
| 17:11 | RO | 00h | Core | Address Mask (ADMSK): Hardwired to 0s to indicate 256 KB address range. |
| 10:1 | RO | 000h | Core | Reserved: Hardwired to 0s. |
| 0 | RO | 0b | Core | ROM BIOS Enable (RBE): 0 = ROM not accessible. |

9.2.14 CAPPOINT—Capabilities Pointer

B/D/F/Type: 0/2/1/PCI
 Address Offset: 34h
 Default Value: D0h
 Access: RO
 Size: 8 bits

| Bit | Access | Default Value | RST/PWR | Description |
|-----|--------|---------------|---------|--------------------------------------------------------------------------------------------------------------------------------------------------------------------------------------------------------------------|
| 7:0 | RO | D0h | Core | Capabilities Pointer Value (CPV): This field contains an offset into the function's PCI Configuration Space for the first item in the New Capabilities Linked List, the Power Management capability at D0h. |



9.2.15 MINGNT—Minimum Grant

B/D/F/Type: 0/2/1/PCI
 Address Offset: 3Eh
 Default Value: 00h
 Access: RO
 Size: 8 bits

| Bit | Access | Default Value | RST/PWR | Description |
|-----|--------|---------------|---------|-------------------------------------------------------------------------------------|
| 7:0 | RO | 00h | Core | Minimum Grant Value (MGV): The IGD does not burst as a PCI compliant master. |

9.2.16 MAXLAT—Maximum Latency

B/D/F/Type: 0/2/1/PCI
 Address Offset: 3Fh
 Default Value: 00h
 Access: RO
 Size: 8 bits

| Bit | Access | Default Value | RST/PWR | Description |
|-----|--------|---------------|---------|------------------------------------------------------------------------------------------------------------------------|
| 7:0 | RO | 00h | Core | Maximum Latency Value (MLV): The IGD has no specific requirements for how often it needs to access the PCI bus. |

9.2.17 CAPIDO—Mirror of Dev0 Capability Identifier

B/D/F/Type: 0/2/1/PCI
 Address Offset: 40-4Ch
 Default Value: 0000000000000000000010C0009h
 Access: RO
 Size: 104 bits
 BIOS Optimal Default 0h

| Bit | Access | Default Value | RST/PWR | Description |
|--------|--------|---------------|---------|----------------------------------------------------------------------------------------------------------------------------------------------------------------|
| 103:28 | RO | 0000b | Core | Reserved |
| 27:24 | RO | 1h | Core | CAPID Version (CAPIDV): This field has the value 0001b to identify the first revision of the CAPID register definition. |
| 23:16 | RO | 0Ch | Core | CAPID Length (CAPIDL): This field has the value 0Ch to indicate the structure length (12 bytes). |
| 15:8 | RO | 00h | Core | Next Capability Pointer (NCP): This field is hardwired to 00h indicating the end of the capabilities linked list. |
| 7:0 | RO | 09h | Core | Capability Identifier (CAP_ID): This field has the value 1001b to identify the CAP_ID assigned by the PCI SIG for vendor dependent capability pointers. |

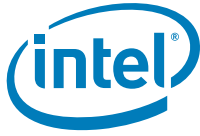

9.2.18 MGGC—Mirror of Device 0 GMCH Graphics Control Register

B/D/F/Type: 0/2/1/PCI
 Address Offset: 52-53h
 Default Value: 0030h
 Access: RO
 Size: 16 bits

Note: All the bits in this register are locked in Intel TXT mode (82Q45/82Q43 GMCH only).

| Bit | Access | Default Value | RST/PWR | Description |
|-------|--------|---------------|---------|-----------------------------------------------------------------------------------------------------------------------------------------------------------------------------------------------------------------------------------------------------------------------------------------------------------------------------------------------------------------------------------------------------------------------------------------------------------------------------------------------------------------------------------------------------------------------------------------------------------------------------------------------------------------------------------------------------------------------------------------------------------------------------------------------------------------------------------------------------------------------------------------------------------------------------------------------------------------------------------------------------------------------------------------------------------------------------------------------------------------------------------------------------------------------------------------------------------------------------------------------------------------------------------------------------------------------|
| 15:12 | RO | 0h | Core | Reserved |
| 11:8 | RO | 0h | Core | <p>GTT Graphics Memory Size (GGMS): This field is used to select the amount of Main Memory that is pre-allocated to support the Internal Graphics Translation Table. The BIOS ensures that memory is pre-allocated only when Internal graphics is enabled.</p> <p>GSM is assumed to be a contiguous physical DRAM space with DSM, and BIOS needs to allocate a contiguous memory chunk. Hardware will drive the base of GSM from DSM only using the GSM size programmed in the register.</p> <p>0000 = No memory pre-allocated. 0001 = No VT mode, 1 MB of memory pre-allocated for GTT. 0011 = No VT mode, 2 MB of memory pre-allocated for GTT 1001 = VT mode, 2 MB of memory pre-allocated for 1 MB of Global GTT and 1 MB for Shadow GTT (82Q45 GMCH only) 1010 = VT mode, 3 MB of memory pre-allocated for 1.5 MB of Global GTT and 1.5 MB for Shadow GTT (82Q45 GMCH only) 1011 = VT mode, 4 MB of memory pre-allocated for 2 MB of Global GTT and 2 MB for Shadow GTT (82Q45 GMCH only)</p> <p>NOTE: All unspecified encodings of this register field are reserved; hardware functionality is not ensured if used. This register is locked and becomes Read Only when the D_LCK bit in the SMRAM register is set.</p> |



| Bit | Access | Default Value | RST/ PWR | Description |
|-----|--------|---------------|-------------|-------------------------------------------------------------------------------------------------------------------------------------------------------------------------------------------------------------------------------------------------------------------------------------------------------------------------------------------------------------------------------------------------------------------------------------------------------------------------------------------------------------------------------------------------------------------------------------------------------------------------------------------------------------------------------------------------------------------------------------------------------------------------------------------------------------------------------------------------------------------------------------------------------------------------------------------------------------------------------------------------------------------------------------------------------------------------------------------------------------------------------------------------------------------------------------------------------------------------------------------------------------------------------------------------------------------------------------------------------------------------------------------------------------------------------------------------------------------------------------------------------------------------------------------------------------------------------------------------------------------------------------------------|
| 7:4 | RO | 0011b | Core | <p>Graphics Mode Select (GMS): This field is used to select the amount of Main Memory that is pre-allocated to support the Internal Graphics device in VGA (non-linear) and Native (linear) modes. The BIOS ensures that memory is pre-allocated only when Internal graphics is enabled.</p> <p>0000 = No memory pre-allocated. Device 2 (IGD) does not claim VGA cycles (Memory and I/O), and the Sub-Class Code field within Device 2, function 0 Class Code register is 80h.</p> <p>0001 = Reserved</p> <p>0010 = Reserved</p> <p>0011 = Reserved</p> <p>0100 = Reserved</p> <p>0101 = DVMT (UMA) mode, 32 MB of memory pre-allocated for frame buffer.</p> <p>0110 = DVMT (UMA) mode, 48 MB of memory pre-allocated for frame buffer.</p> <p>0111 = DVMT (UMA) mode, 64 MB of memory pre-allocated for frame buffer.</p> <p>1000 = DVMT (UMA) mode, 128 MB of memory pre-allocated for frame buffer.</p> <p>1001 = DVMT (UMA) mode, 256 MB of memory pre-allocated for frame buffer.</p> <p>1010 = DVMT (UMA) mode, 96 MB of memory pre-allocated (0 + 96).</p> <p>1011 = DVMT (UMA) mode, 160 MB of memory pre-allocated (64 + 96).</p> <p>1100 = DVMT (UMA) mode, 224 MB of memory pre-allocated (128 + 96).</p> <p>1101 = DVMT (UMA) mode, 352 MB of memory pre-allocated (256 + 96).</p> <p>NOTE: This register is locked and becomes Read Only when the D_LCK bit in the SMRAM register is set.</p> <p>Hardware does not clear or set any of these bits automatically based on IGD being disabled/enabled.</p> <p>BIOS Requirement: BIOS must not set this field to 000 if IVD (bit 1 of this register) is 0.</p> |
| 3:2 | RO | 00b | Core | Reserved |
| 1 | RO | 0b | Core | <p>IGD VGA Disable (IVD):</p> <p>0 = Enable. Device 2 (IGD) claims VGA memory and I/O cycles, and the Sub-Class Code within Device 2 Class Code register is 00h.</p> <p>1 = Disable. Device 2 (IGD) does not claim VGA cycles (Memory and I/O), and the Sub-Class Code field within Device 2, Function 0 Class Code register is 80h.</p> <p>BIOS Requirement: BIOS must not set this bit to 0 if the GMS field (bits 6:4 of this register) pre-allocates no memory.</p> <p>This bit MUST be set to 1 if Device 2 is disabled either via a fuse or fuse override (CAPIDO[38] = 1) or via a register (DEVEN[3] = 0).</p> |
| 0 | RO | 0b | Core | Reserved |



9.2.19 DEVEN—Device Enable

B/D/F/Type: 0/2/1/PCI
 Address Offset: 54-57h
 Default Value: 000023DBh
 Access: RO
 Size: 32 bits

This register allows for enabling/disabling of PCI devices and functions that are within the GMCH.

Note: All the bits in this register are locked in Intel TXT mode (82Q45/82Q43 GMCH only).

| Bit | Access | Default Value | RST/PWR | Description |
|-------|--------|---------------|---------|--------------------------------------------------------------------------------------------------------------------------------------------------------------------------------------------------------------------------------------------------------------------------------------------------------------------------------------|
| 31:15 | RO | 00000h | Core | Reserved |
| 14 | RO | 0b | Core | Chap Enable (D7EN): 0 = Bus 0, Device 7 is disabled and not visible. 1 = Bus 0, Device 7 is enabled and visible. Non-production BIOS code should provide a setup option to enable Bus 0, Device 7. When enabled, Bus 0, Device 7 must be initialized in accordance to standard PCI device initialization procedures. |
| 13 | RO | 1b | Core | PEG1 Enable (D6EN): 0 = Bus 0 Device 6 is disabled and hidden. 1 = Bus 0, Device 6 is enabled and visible. |
| 12:10 | RO | 00b | Core | Reserved |
| 9 | RO | 1b | Core | EP Function 3 (D3F3EN): 0 = Bus 0, Device 3, Function 3 is disabled and hidden 1 = Bus 0, Device 3, Function 3 is enabled and visible If Device 3, Function 0 is disabled and hidden, then Device 3, Function 3 is also disabled and hidden independent of the state of this bit. |
| 8 | RO | 1b | Core | EP Function 2 (D3F2EN): 0 = Bus 0, Device 3, Function 2 is disabled and hidden 1 = Bus 0, Device 3, Function 2 is enabled and visible If Device 3, Function 0 is disabled and hidden, then Device 3, Function 2 is also disabled and hidden independent of the state of this bit. |
| 7 | RO | 1b | Core | EP Function 1 (D3F1EN): 0 = Bus 0, Device 3, Function 1 is disabled and hidden 1 = Bus 0, Device 3, Function 1 is enabled and visible. If this GMCH does not have ME capability (CAPIDO[??] = 1), then Device 3 Function 1 is disabled and hidden independent of the state of this bit. |
| 6 | RO | 1b | Core | EP Function 0 (D3F0EN): 0 = Bus 0, Device 3, Function 0 is disabled and hidden 1 = Bus 0, Device 3, Function 0 is enabled and visible. If this GMCH does not have ME capability (CAPIDO[??] = 1), then Device 3, Function 0 is disabled and hidden independent of the state of this bit. |



| Bit | Access | Default Value | RST/PWR | Description |
|-----|--------|---------------|---------|-----------------------------------------------------------------------------------------------------------------------------------------------------------------------------------------------------------------------------------------------------------------------------------------------------------------------------------------------------------------------------------------------------------------------------------------------------------------------------------------------------------------------------------------------------------------------------------------|
| 5 | RO | 0b | Core | Reserved |
| 4 | RO | 1b | Core | <p>Internal Graphics Engine Function 1 (D2F1EN): 0 = Bus 0, Device 2, Function 1 is disabled and hidden 1 = Bus 0, Device 2, Function 1 is enabled and visible If Device 2, Function 0 is disabled and hidden, then Device 2, Function 1 is also disabled and hidden independent of the state of this bit. If this component is not capable of Dual Independent Display (CAPID0[78] = 1), then this bit is hardwired to 0b to hide Device 2 Function 1.</p> |
| 3 | RO | 1b | Core | <p>Internal Graphics Engine Function 0 (D2F0EN): 0 = Bus 0, Device 2, Function 0 is disabled and hidden 1 = Bus 0, Device 2, Function 0 is enabled and visible If this GMCH does not have internal graphics capability (CAPID0[46] = 1), then Device 2, Function 0 is disabled and hidden independent of the state of this bit.</p> |
| 2 | RO | 0b | Core | Reserved |
| 1 | RO | 1b | Core | <p>PCI Express Port (D1EN): 0 = Bus 0, Device 1, Function 0 is disabled and hidden. 1 = Bus 0, Device 1, Function 0 is enabled and visible. Default value is determined by the device capabilities (see CAPID0[44]), SDVO Presence hardware strap and the sDVO/PCIe Concurrent hardware strap. Device 1 is Disabled on Reset if the SDVO Presence strap was sampled high, and the sDVO/PCIe Concurrent strap was sampled low at the last assertion of PWROK, and is enabled by default otherwise.</p> |
| 0 | RO | 1b | Core | <p>Host Bridge (DOEN): Bus 0, Device 0, Function 0 may not be disabled and is therefore hardwired to 1.</p> |

9.2.20 SSRW—Mirror of Function 0 Software Scratch Read Write

B/D/F/Type: 0/2/1/PCI
 Address Offset: 58-5Bh
 Default Value: 00000000h
 Access: RO
 Size: 32 bits

| Bit | Access | Default Value | RST/PWR | Description |
|------|--------|---------------|---------|-------------|
| 31:0 | RO | 00000000h | Core | Reserved |



9.2.21 BSM—Mirror of Function 0 Base of Stolen Memory

B/D/F/Type: 0/2/1/PCI
Address Offset: 5C-5Fh
Default Value: 07800000h
Access: RO
Size: 32 bits

Graphics Stolen Memory and TSEG are within DRAM space defined under TOLUD. From the top of low used DRAM, GMCH claims 1 to 64 MB of DRAM for internal graphics if enabled.

The base of stolen memory will always be below 4 GB. This is required to prevent aliasing between stolen range and the reclaim region.

| Bit | Access | Default Value | RST/PWR | Description |
|-------|--------|---------------|---------|---------------------------------------------------------------------------------------------------------------------------------------------------------------------------------------------------------------------------------------------------------------------------------------|
| 31:20 | RO | 078h | Core | Base of Stolen Memory (BSM): This register contains bits 31:20 of the base address of stolen DRAM memory. The host interface determines the base of Graphics Stolen memory by subtracting the graphics stolen memory size from TOLUD. See Device 0 TOLUD for more explanation. |
| 19:0 | RO | 00000h | Core | Reserved |

9.2.22 HSRW—Mirror of Device 2 Function 0 Hardware Scratch Read Write

B/D/F/Type: 0/2/1/PCI
Address Offset: 60-61h
Default Value: 0000h
Access: RO
Size: 16 bits

| Bit | Access | Default Value | RST/PWR | Description |
|------|--------|---------------|---------|-------------|
| 15:0 | RO | 0000h | Core | Reserved |



9.2.23 GDRST—Mirror of Device 2 Function 0 Graphics Reset

B/D/F/Type: 0/2/1/PCI
 Address Offset: C0h
 Default Value: 00h
 Access: RO
 Size: 8 bits

This register is a mirror of Graphics Reset Register in Device 2.

| Bit | Access | Default Value | RST/PWR | Description |
|-----|--------|---------------|-----------|------------------------------------------------------------------------------------------------------------------------------------------------------------------------------------------------------------------------------------------------------------------------------------------------------------------------------------------------------------------------------------------------------------------------------------------------------------------------------------------------------------------------------------------------------------------------------------------------------------------------------------------------------------------------------------------------------------------------------------------------------------------------------------------------------------------------------------------------------------------------------------------------------------------------------------|
| 7:4 | RO | 0h | Core | Reserved |
| 3:2 | RO | 00b | FLR, Core | Graphics Reset Domain (GRDOM): 00 = Full Graphics Reset will be performed (both render and display clock domain resets asserted) 01 = Render Only Reset (render clock domain reset asserted) 10 = Reserved (Invalid Programming) 11 = Media Only Reset (Media domain reset get asserted) |
| 1 | RO | 0b | Core | Reserved |
| 0 | RO | 0b | Core | Graphics Reset Enable (GR): Setting this bit asserts graphics-only reset. The clock domains to be reset are determined by GRDOM. Hardware resets this bit when the reset is complete. Setting this bit without waiting for it to clear, is undefined behavior. Once this bit is set to a 1, all graphics core MMIO registers are returned to power on default state. All Ring buffer pointers are reset, command stream fetches are dropped and ongoing render pipeline processing is halted, state machines and State Variables returned to power on default state. If the Display is reset, all display engines are halted (garbage on screen). VGA memory is not available, Store DWORDs and interrupts are not ensured to be completed. Device 2 I/O registers are not available. Device 2 Configuration registers continue to be available while Graphics reset is asserted. This bit is hardware auto-clear. |



9.2.24 PMCAPID—Mirror of Fun 0 Power Management Capabilities ID

B/D/F/Type: 0/2/1/PCI
 Address Offset: D0-D1h
 Default Value: 0001h
 Access: R/WO, RO
 Size: 16 bits

This register is a mirror of function 0 with the same R/W attributes.

| Bit | Access | Default Value | RST/PWR | Description |
|------|--------|---------------|---------|-----------------------------------------------------------------------------------------------------------------------------------------------------------------------------------------|
| 15:8 | R/WO | 00h | Core | Next Capability Pointer (NEXT_PTR): This field contains a pointer to next item in capabilities list. BIOS is responsible for writing this to the FLR Capability when applicable. |
| 7:0 | RO | 01h | Core | Capability Identifier (CAP_ID): SIG defines this ID is 01h for power management. |

9.2.25 PMCAP—Mirror of Fun 0 Power Management Capabilities

B/D/F/Type: 0/2/1/PCI
 Address Offset: D2-D3h
 Default Value: 0022h
 Access: RO
 Size: 16 bits

This register is a Mirror of Function 0 with the same read/write attributes. The hardware implements a single physical register common to both functions 0 and 1.

| Bit | Access | Default Value | RST/PWR | Description |
|-------|--------|---------------|---------|-----------------------------------------------------------------------------------------------------------------------------------------------------------------------------------------------------------------------------------|
| 15:11 | RO | 00h | Core | PME Support (PMES): This field indicates the power states in which the IGD may assert PME#. Hardwired to 0 to indicate that the IGD does not assert the PME# signal. |
| 10 | RO | 0b | Core | D2 Support (D2): The D2 power management state is not supported. This bit is hardwired to 0. |
| 9 | RO | 0b | Core | D1 Support (D1): Hardwired to 0 to indicate that the D1 power management state is not supported. |
| 8:6 | RO | 000b | Core | Reserved |
| 5 | RO | 1b | Core | Device Specific Initialization (DSI): Hardwired to 1 to indicate that special initialization of the IGD is required before generic class device driver is to use it. |
| 4 | RO | 0b | Core | Reserved |
| 3 | RO | 0b | Core | PME Clock (PMECLK): Hardwired to 0 to indicate IGD does not support PME# generation. |
| 2:0 | RO | 010b | Core | Version (VER): Hardwired to 010b to indicate that there are 4 bytes of power management registers implemented and that this device complies with revision 1.1 of the <i>PCI Power Management Interface Specification</i> . |



9.2.26 PMCS—Power Management Control/Status

B/D/F/Type: 0/2/1/PCI
 Address Offset: D4-D5h
 Default Value: 0000h
 Access: RO, R/W
 Size: 16 bits

| Bit | Access | Default Value | RST/PWR | Description |
|-------|--------|---------------|-----------|--------------------------------------------------------------------------------------------------------------------------------------------------------------------------------------------------------------------------------------------------------------------------------------------------------------------------------------------------------------------------------------------------------------------------------------------------------------------------------------------------------|
| 15 | RO | 0b | Core | PME Status (PMESTS) : This bit is 0 to indicate that IGD does not support PME# generation from D3 (cold). |
| 14:13 | RO | 00b | Core | Data Scale (DSCALE) : The IGD does not support data register. This bit always returns 0 when read, write operations have no effect. |
| 12:9 | RO | 0h | Core | Data Select (DATASEL) : The IGD does not support data register. This bit always returns 0 when read, write operations have no effect. |
| 8 | RO | 0b | Core | PME Enable (PME_EN) : This bit is 0 to indicate that PME# assertion from D3 (cold) is disabled. |
| 7:2 | RO | 00h | Core | Reserved |
| 1:0 | R/W | 00b | FLR, Core | Power State (PWRSTAT) : This field indicates the current power state of the IGD and can be used to set the IGD into a new power state. If software attempts to write an unsupported state to this field, write operation must complete normally on the bus, but the data is discarded and no state change occurs. On a transition from D3 to D0 the graphics controller is optionally reset to initial values. 00 = Default 01 = D1 (Not Supported) 10 = D2 (Not Supported) 11 = D3 |

9.2.27 SWSMI—Mirror of Func0 Software SMI

B/D/F/Type: 0/2/1/PCI
 Address Offset: E0-E1h
 Default Value: 0000h
 Access: RO
 Size: 16 bits

Since there is the potential that DVO port legacy drivers exist that expect this register at this address, Device 2, Function 0, address E0h–E1h is reserved for this register.

| Bit | Access | Default Value | RST/PWR | Description |
|------|--------|---------------|---------|------------------------------------------------------------------------------------------------------------------------------|
| 15:8 | RO | 00h | Core | Software Scratch Bits (SWSB) : |
| 7:1 | RO | 00h | Core | Software Flag (SWF) : Used to indicate caller and SMI function desired, as well as return result. |
| 0 | RO | 0b | Core | GMCH Software SMI Event (GSSMIE) : When Set, this bit will trigger an SMI. Software must write a 0 to clear this bit. |

§ §

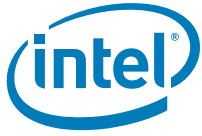



10 Intel® Manageability Engine Subsystem Registers

10.1 HECI Function in ME subsystem Registers

Table 17. HECI Function in ME Subsystem Register Address Map

| Address Offset | Register Symbol | Register Name | Default Value | Access |
|----------------|-----------------|-----------------------------------------------------|-----------------------|---------------|
| 0–3h | ID | Identifiers | 2E048086h | RO |
| 4–5h | CMD | Command | 0000h | RO, R/W |
| 6–7h | STS | Device Status | 0010h | RO |
| 8h | RID | Revision ID | see description | RO |
| 9–Bh | CC | Class Code | 0C8001h | RO |
| Ch | CLS | Cache Line Size | 00h | RO |
| Dh | MLT | Master Latency Timer | 00h | RO |
| Eh | HTYPE | Header Type | 80h | RO |
| Fh | BIST | Built In Self Test | 00h | RO |
| 10–17h | HECI_MBAR | HECI MMIO Base Address | 0000000000 000004h | RO, R/W |
| 2C–2Fh | SS | Sub System Identifiers | 00000000h | R/WO |
| 34h | CAP | Capabilities Pointer | 50h | RO |
| 3C–3Dh | INTR | Interrupt Information | 0100h | RO, R/W |
| 3Eh | MGNT | Minimum Grant | 00h | RO |
| 3F | MLAT | Maximum Latency | 00h | RO |
| 40–43h | HFS | Host Firmware Status | 00000000h | RO |
| 50–51h | PID | PCI Power Management Capability ID | 8C01h | RO |
| 52–53h | PC | PCI Power Management Capabilities | C803h | RO |
| 54–55h | PMCS | PCI Power Management Control And Status | 0008h | R/WC, RO, R/W |
| 8C–8Dh | MID | Message Signaled Interrupt Identifiers | 0005h | RO |
| 8E–8Fh | MC | Message Signaled Interrupt Message Control | 0080h | RO, R/W |
| 90–93h | MA | Message Signaled Interrupt Message Address | 00000000h | R/W, RO |
| 94–97h | MUA | Message Signaled Interrupt Upper Address (Optional) | 00000000h | R/W |
| 98–99h | MD | Message Signaled Interrupt Message Data | 0000h | R/W |

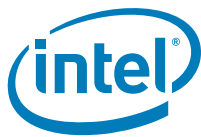

10.1.1 ID— Identifiers

B/D/F/Type: 0/3/0/PCI
Address Offset: 0-3h
Default Value: 2E048086h
Access: RO
Size: 32 bits

| Bit | Access | Default Value | RST/PWR | Description |
|-------|--------|---------------|---------|-----------------------------------------------------------------------------------------------------|
| 31:16 | RO | 2E04h | Core | Device ID (DID) : Indicates what device number assigned by Intel. |
| 15:0 | RO | 8086h | Core | Vendor ID (VID) : 16-bit field which indicates Intel is the vendor, assigned by the PCI SIG. |

10.1.2 CMD— Command

B/D/F/Type: 0/3/0/PCI
Address Offset: 4-5h
Default Value: 0000h
Access: RO, R/W
Size: 16 bits

| Bit | Access | Default Value | RST/PWR | Description |
|-------|--------|---------------|---------|-----------------------------------------------------------------------------------------------------------------------------------------------------|
| 15:11 | RO | 00000b | Core | Reserved |
| 10 | R/W | 0b | Core | Interrupt Disable (ID) : Disables this device from generating PCI line based interrupts. This bit does not have any effect on MSI operation. |
| 9 | RO | 0b | Core | Fast Back-to-Back Enable (FBE) : Not implemented, hardwired to 0. |
| 8 | RO | 0b | Core | SERR# Enable (SEE) : Not implemented, hardwired to 0. |
| 7 | RO | 0b | Core | Wait Cycle Enable (WCC) : Not implemented, hardwired to 0. |
| 6 | RO | 0b | Core | Parity Error Response Enable (PEE) : Not implemented, hardwired to 0. |
| 5 | RO | 0b | Core | VGA Palette Snooping Enable (VGA) : Not implemented, hardwired to 0. |
| 4 | RO | 0b | Core | Memory Write and Invalidate Enable (MWIE) : Not implemented, hardwired to 0. |
| 3 | RO | 0b | Core | Special Cycle Enable (SCE) : Not implemented, hardwired to 0. |

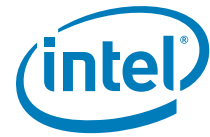

| Bit | Access | Default Value | RST/PWR | Description |
|-----|--------|---------------|---------|---------------------------------------------------------------------------------------------------------------------------------------------------------------------------------------------------------------------------------------------------------------------------------------------------------------------------------------------------------------------------------------------------------------------------------------------------------------------------------------------------------------------------------------------------------------------------------------------------------------------------------------------------------------------------------------------------------------------------------------------------------|
| 2 | R/W | 0b | Core | <p>Bus Master Enable (BME): This bit controls the HECI host controller's ability to act as a system memory master for data transfers. When this bit is cleared, HECI bus master activity stops and any active DMA engines return to an idle condition. This bit is made visible to firmware through the H_PCI_CSR register, and changes to this bit may be configured by the H_PCI_CSR register to generate an ME MSI.</p> <p>When this bit is 0, HECI is blocked from generating MSI to the host processor.</p> <p>Note that this bit does not block HECI accesses to ME-UMA (i.e., writes or reads to the host and ME circular buffers through the read window and write window registers still cause ME backbone transactions to ME-UMA).</p> |
| 1 | R/W | 0b | Core | <p>Memory Space Enable (MSE): This bit controls access to the HECI host controller's memory mapped register space.</p> |
| 0 | RO | 0b | Core | <p>I/O Space Enable (IOSE): Not implemented, hardwired to 0.</p> |

10.1.3 STS— Device Status

B/D/F/Type: 0/3/0/PCI
 Address Offset: 6-7h
 Default Value: 0010h
 Access: RO
 Size: 16 bits

| Bit | Access | Default Value | RST/PWR | Description |
|------|--------|---------------|---------|-----------------------------------------------------------------------------------------|
| 15 | RO | 0b | Core | <p>Detected Parity Error (DPE): Not implemented, hardwired to 0.</p> |
| 14 | RO | 0b | Core | <p>Signaled System Error (SSE): Not implemented, hardwired to 0.</p> |
| 13 | RO | 0b | Core | <p>Received Master-Abort (RMA): Not implemented, hardwired to 0.</p> |
| 12 | RO | 0b | Core | <p>Received Target Abort (RTA): Not implemented, hardwired to 0.</p> |
| 11 | RO | 0b | Core | <p>Signaled Target-Abort (STA): Not implemented, hardwired to 0.</p> |
| 10:9 | RO | 00b | Core | <p>DEVSEL# Timing (DEVT): These bits are hardwired to 00.</p> |
| 8 | RO | 0b | Core | <p>Master Data Parity Error Detected (DPD): Not implemented, hardwired to 0.</p> |
| 7 | RO | 0b | Core | <p>Fast Back-to-Back Capable (FBC): Not implemented, hardwired to 0.</p> |
| 6 | RO | 0b | Core | Reserved |
| 5 | RO | 0b | Core | <p>66 MHz Capable (C66): Not implemented, hardwired to 0.</p> |



| Bit | Access | Default Value | RST/PWR | Description |
|-----|--------|---------------|---------|-----------------------------------------------------------------------------------------------|
| 4 | RO | 1b | Core | Capabilities List (CL): Indicates the presence of a capabilities list, hardwired to 1. |
| 3 | RO | 0b | Core | Interrupt Status (IS): Indicates the interrupt status of the device (1 = asserted). |
| 2:0 | RO | 000b | Core | Reserved |

10.1.4 RID— Revision ID

B/D/F/Type: 0/3/0/PCI
 Address Offset: 8h
 Default Value: see description below
 Access: RO
 Size: 8 bits

| Bit | Access | Default Value | RST/PWR | Description |
|-----|--------|-----------------|---------|-----------------------------------------------------------------------------------------------------------------------------------------------------------------------------------|
| 7:0 | RO | see description | Core | Revision ID (RID): Indicates stepping of the HECI host controller. Refer to the <i>Intel® 4 Series Chipset Family Specification Update</i> for the value of this register. |

10.1.5 CC— Class Code

B/D/F/Type: 0/3/0/PCI
 Address Offset: 9-Bh
 Default Value: 0C8001h
 Access: RO
 Size: 24 bits

| Bit | Access | Default Value | RST/PWR | Description |
|-------|--------|---------------|---------|-----------------------------------------------------------------------------------------------------------------------|
| 23:16 | RO | 0ch | Core | Base Class Code (BCC): This field indicates the base class code of the HECI host controller device. |
| 15:8 | RO | 80h | Core | Sub Class Code (SCC): This field indicates the sub class code of the HECI host controller device. |
| 7:0 | RO | 01h | Core | Programming Interface (PI): This field indicates the programming interface of the HECI host controller device. |



10.1.6 CLS— Cache Line Size

B/D/F/Type: 0/3/0/PCI
 Address Offset: Ch
 Default Value: 00h
 Access: RO
 Size: 8 bits

| Bit | Access | Default Value | RST/PWR | Description |
|-----|--------|---------------|---------|----------------------------------------------------------------|
| 7:0 | RO | 00h | Core | Cache Line Size (CLS): Not implemented, hardwired to 0. |

10.1.7 MLT— Master Latency Timer

B/D/F/Type: 0/3/0/PCI
 Address Offset: Dh
 Default Value: 00h
 Access: RO
 Size: 8 bits

| Bit | Access | Default Value | RST/PWR | Description |
|-----|--------|---------------|---------|---------------------------------------------------------------------|
| 7:0 | RO | 00h | Core | Master Latency Timer (MLT): Not implemented, hardwired to 0. |

10.1.8 HTYPE— Header Type

B/D/F/Type: 0/3/0/PCI
 Address Offset: Eh
 Default Value: 80h
 Access: RO
 Size: 8 bits

| Bit | Access | Default Value | RST/PWR | Description |
|-----|--------|---------------|---------|---------------------------------------------------------------------------------------------------------------------|
| 7 | RO | 1b | Core | Multi-Function Device (MFD): This bit indicates the HECI host controller is part of a multi-function device. |
| 6:0 | RO | 0000000b | Core | Header Layout (HL): This field indicates that the HECI host controller uses a target device layout. |



10.1.9 BIST— Built In Self Test

B/D/F/Type: 0/3/0/PCI
 Address Offset: Fh
 Default Value: 00h
 Access: RO
 Size: 8 bits

| Bit | Access | Default Value | RST/PWR | Description |
|-----|--------|---------------|---------|-------------------------------------------------------------|
| 7 | RO | 0b | Core | BIST Capable (BC) : Not implemented, hardwired to 0. |
| 6:0 | RO | 0000000b | Core | Reserved |

10.1.10 HECI_MBAR— HECI MMIO Base Address

B/D/F/Type: 0/3/0/PCI
 Address Offset: 10-17h
 Default Value: 0000000000000004h
 Access: RO, R/W
 Size: 64 bits

This register allocates space for the HECI memory mapped registers.

| Bit | Access | Default Value | RST/PWR | Description |
|------|--------|----------------------|---------|------------------------------------------------------------------------------------------------------------------------------------------------------------------------------------------------------------------------------|
| 63:4 | R/W | 000000000 000000h | Core | Base Address (BA) : Base address of register memory space. |
| 3 | RO | 0b | Core | Prefetchable (PF) : This bit indicates that this range is not pre-fetchable |
| 2:1 | RO | 10b | Core | Type (TP) : This field indicates that this range can be mapped anywhere in 64-bit address space. Note that the (G)MCH only uses bits 35:4 of the base address field as the (G)MCH only decodes FSB address bits 35:4. |
| 0 | RO | 0b | Core | Resource Type Indicator (RTE) : Indicates a request for register memory space. |



10.1.11 SS— Sub System Identifiers

B/D/F/Type: 0/3/0/PCI
 Address Offset: 2C-2Fh
 Default Value: 00000000h
 Access: R/WO
 Size: 32 bits

| Bit | Access | Default Value | RST/PWR | Description |
|-------|--------|---------------|---------|----------------------------------------------------------------------------------------------------------------------------------------------------------------------------------------------------------------------------------------------|
| 31:16 | R/WO | 0000h | Core | Subsystem ID (SSID): This field indicates the sub-system identifier. This field should be programmed by BIOS during boot-up. Once written, this register becomes Read Only. This field can only be cleared by PLTRST#. |
| 15:0 | R/WO | 0000h | Core | Subsystem Vendor ID (SSVID): This field indicates the sub-system vendor identifier. This field should be programmed by BIOS during boot-up. Once written, this register becomes Read Only. This field can only be cleared by PLTRST#. |

10.1.12 CAP— Capabilities Pointer

B/D/F/Type: 0/3/0/PCI
 Address Offset: 34h
 Default Value: 50h
 Access: RO
 Size: 8 bits

| Bit | Access | Default Value | RST/PWR | Description |
|-----|--------|---------------|---------|----------------------------------------------------------------------------------------------------------------------------------------------------|
| 7:0 | RO | 50h | Core | Capability Pointer (CP): This field indicates the first capability pointer offset. It points to the PCI power management capability offset. |



10.1.13 INTR— Interrupt Information

B/D/F/Type: 0/3/0/PCI
Address Offset: 3C-3Dh
Default Value: 0100h
Access: RO, R/W
Size: 16 bits

| Bit | Access | Default Value | RST/PWR | Description |
|------|--------|---------------|---------|--------------------------------------------------------------------------------------------------------------------------------------------------------------------------------------------------------------------------------------------------------------------------------|
| 15:8 | RO | 01h | Core | Interrupt Pin (IPIN): This field indicates the interrupt pin the HECI host controller uses. The value of 01h selects INTA# interrupt pin. NOTE: As HECI is an internal device in the (G)MCH, the INTA# pin is implemented as an INTA# message to the ICH. |
| 7:0 | R/W | 00h | Core | Interrupt Line (ILINE): Software written value to indicate which interrupt line (vector) the interrupt is connected to. No hardware action is taken on this register. |

10.1.14 MGNT— Minimum Grant

B/D/F/Type: 0/3/0/PCI
Address Offset: 3Eh
Default Value: 00h
Access: RO
Size: 8 bits

| Bit | Access | Default Value | RST/PWR | Description |
|-----|--------|---------------|---------|------------------------------------------------------|
| 7:0 | RO | 00h | Core | Grant (GNT): Not implemented, hardwired to 0. |

10.1.15 MLAT— Maximum Latency

B/D/F/Type: 0/3/0/PCI
Address Offset: 3Fh
Default Value: 00h
Access: RO
Size: 8 bits

| Bit | Access | Default Value | RST/PWR | Description |
|-----|--------|---------------|---------|--------------------------------------------------------|
| 7:0 | RO | 00h | Core | Latency (LAT): Not implemented, hardwired to 0. |



10.1.16 HFS— Host Firmware Status

B/D/F/Type: 0/3/0/PCI
 Address Offset: 40-43h
 Default Value: 00000000h
 Access: RO
 Size: 32 bits

| Bit | Access | Default Value | RST/PWR | Description |
|------|--------|---------------|---------|----------------------------------------------------------------------------------------------------------------------------------------------------------------------------------------------------------------------------|
| 31:0 | RO | 00000000h | Core | Firmware Status Host Access (FS_HA): This field indicates current status of the firmware for the HECI controller. This field is the host's read only access to the FS field in the ME Firmware Status AUX register. |

10.1.17 PID— PCI Power Management Capability ID

B/D/F/Type: 0/3/0/PCI
 Address Offset: 50-51h
 Default Value: 8C01h
 Access: RO
 Size: 16 bits

| Bit | Access | Default Value | RST/PWR | Description |
|------|--------|---------------|---------|---------------------------------------------------------------------------------------------------------------------------------------------------------------|
| 15:8 | RO | 8Ch | Core | Next Capability (NEXT): This field indicates the location of the next capability item in the list. This is the Message Signaled Interrupts capability. |
| 7:0 | RO | 01h | Core | Cap ID (CID): This field indicates that this pointer is a PCI power management. |



10.1.18 PC— PCI Power Management Capabilities

B/D/F/Type: 0/3/0/PCI
Address Offset: 52-53h
Default Value: C803h
Access: RO
Size: 16 bits

| Bit | Access | Default Value | RST/PWR | Description |
|-------|--------|---------------|---------|----------------------------------------------------------------------------------------------------------------------------------------------------------------------------|
| 15:11 | RO | 11001b | Core | PME_Support (PSUP) : This field indicates the states that can generate PME#. HECI can assert PME# from any D-state except D1 or D2 which are not supported by HECI. |
| 10 | RO | 0b | Core | D2_Support (D2S) : The D2 state is not supported for the HECI host controller. |
| 9 | RO | 0b | Core | D1_Support (D1S) : The D1 state is not supported for the HECI host controller. |
| 8:6 | RO | 000b | Core | Aux_Current (AUXC) : This field reports the maximum Suspend well current required when in the D3COLD state. Value of TBD is reported. |
| 5 | RO | 0b | Core | Device Specific Initialization (DSI) : This bit indicates whether device-specific initialization is required. |
| 4 | RO | 0b | Core | Reserved |
| 3 | RO | 0b | Core | PME Clock (PMEC) : This bit indicates that PCI clock is not required to generate PME#. |
| 2:0 | RO | 011b | Core | Version (VS) : This field indicates support for Revision 1.2 of the <i>PCI Power Management Specification</i> . |



10.1.19 PMCS— PCI Power Management Control And Status

B/D/F/Type: 0/3/0/PCI
 Address Offset: 54-55h
 Default Value: 0008h
 Access: R/WC, RO, R/W
 Size: 16 bits

| Bit | Access | Default Value | RST/PWR | Description |
|------|--------|---------------|---------|-----------------------------------------------------------------------------------------------------------------------------------------------------------------------------------------------------------------------------------------------------------------------------------------------------------------------------------------------------------------------------------------------------------------------------------------------------------------------------------------------------------------------------------------------------------------------------------------------------------------|
| 15 | R/WC | 0b | Core | <p>PME Status (PMES): The PME Status bit in HECI space can be set to 1 by ARC FW performing a write into AUX register to set PMES.</p> <p>This bit is cleared by host processor writing a 1 to it. ARC cannot clear this bit.</p> <p>Host processor writes with value 0 have no effect on this bit.</p> <p>This bit is reset to 0 by MRST#.</p> |
| 14:9 | RO | 000000b | Core | Reserved. |
| 8 | R/W | 0b | Core | <p>PME Enable (PMEE): This bit is read/write, under control of host SW. It does not directly have an effect on PME events. However, this bit is shadowed into AUX space so ARC FW can monitor it. The ARC FW is responsible for ensuring that FW does not cause the PME-S bit to transition to 1 while the PMEE bit is 0, indicating that host software had disabled PME.</p> <p>This bit is reset to 0 by MRST#.</p> |
| 7:4 | RO | 0000b | Core | Reserved |
| 3 | RO | 1b | Core | <p>No_Soft_Reset (NSR): This bit indicates that when the HECI host controller is transitioning from D3hot to D0 due to power state command. It does not perform an internal reset. Configuration context is Reserved.</p> |
| 2 | RO | 0b | Core | Reserved |
| 1:0 | R/W | 00b | Core | <p>Power State (PS): This field is used both to determine the current power state of the HECI host controller and to set a new power state. The values are:</p> <p>00 = D0 state 11 = D3HOT state</p> <p>The D1 and D2 states are not supported for this HECI host controller. When in the D3HOT state, the HBA's configuration space is available, but the register memory spaces are not. Additionally, interrupts are blocked. This field is visible to firmware through the H_PCI_CSR register, and changes to this field may be configured by the H_PCI_CSR register to generate an ME MSI.</p> |

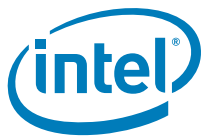

10.1.20 MID— Message Signaled Interrupt Identifiers

B/D/F/Type: 0/3/0/PCI
 Address Offset: 8C-8Dh
 Default Value: 0005h
 Access: RO
 Size: 16 bits

| Bit | Access | Default Value | RST/PWR | Description |
|------|--------|---------------|---------|--------------------------------------------------------------------------------------------------------------------------------------------------------------------------------|
| 15:8 | RO | 00h | Core | Next Pointer (NEXT) : Indicates the next item in the list. This can be other capability pointers (such as PCI-X or PCI-Express) or it can be the last item in the list. |
| 7:0 | RO | 05h | Core | Capability ID (CID) : Capabilities ID indicates MSI. |

10.1.21 MC— Message Signaled Interrupt Message Control

B/D/F/Type: 0/3/0/PCI
 Address Offset: 8E-8Fh
 Default Value: 0080h
 Access: RO, R/W
 Size: 16 bits

| Bit | Access | Default Value | RST/PWR | Description |
|------|--------|---------------|---------|-----------------------------------------------------------------------------------------------------------------------|
| 15:8 | RO | 00h | Core | Reserved |
| 7 | RO | 1b | Core | 64 Bit Address Capable (C64) : Specifies whether capable of generating 64-bit messages. |
| 6:4 | RO | 000b | Core | Multiple Message Enable (MME) : Not implemented, hardwired to 0. |
| 3:1 | RO | 000b | Core | Multiple Message Capable (MMC) : Not implemented, hardwired to 0. |
| 0 | R/W | 0b | Core | MSI Enable (MSIE) : If set, MSI is enabled and traditional interrupt pins are not used to generate interrupts. |

10.1.22 MA— Message Signaled Interrupt Message Address

B/D/F/Type: 0/3/0/PCI
 Address Offset: 90-93h
 Default Value: 00000000h
 Access: R/W, RO
 Size: 32 bits

| Bit | Access | Default Value | RST/PWR | Description |
|------|--------|---------------|---------|------------------------------------------------------------------------------------------------------|
| 31:2 | R/W | 00000000h | Core | Address (ADDR) : Lower 32 bits of the system specified message address, always DWord aligned. |
| 1:0 | RO | 00b | Core | Reserved |



10.1.23 MUA— Message Signaled Interrupt Upper Address (Optional)

B/D/F/Type: 0/3/0/PCI
 Address Offset: 94-97h
 Default Value: 00000000h
 Access: R/W
 Size: 32 bits

| Bit | Access | Default Value | RST/PWR | Description |
|------|--------|---------------|---------|--------------------------------------------------------------------------------------------------------------------------------------------------|
| 31:0 | R/W | 00000000h | Core | Upper Address (UADDR): Upper 32 bits of the system specified message address. This register is optional and only implemented if MC.C64=1. |

10.1.24 MD— Message Signaled Interrupt Message Data

B/D/F/Type: 0/3/0/PCI
 Address Offset: 98-99h
 Default Value: 0000h
 Access: R/W
 Size: 16 bits

| Bit | Access | Default Value | RST/PWR | Description |
|------|--------|---------------|---------|-----------------------------------------------------------------------------------------------------------------------------------------------------------------------------------------|
| 15:0 | R/W | 0000h | Core | Data (Data): This 16-bit field is programmed by system software if MSI is enabled. Its content is driven onto the FSB during the data phase of the MSI memory write transaction. |



10.2 Second HECI Function in ME Subsystem Registers

Table 18. Second HECI Function in ME Subsystem Register Address Map

| Address Offset | Register Symbol | Register Name | Default Value | Access |
|----------------|-----------------|-----------------------------------------------------|--------------------------|---------------|
| 0–3h | ID | Identifiers | 2E058086h | RO |
| 4–5h | CMD | Command | 0000h | RO, R/W |
| 6–7h | STS | Device Status | 0010h | RO |
| 8h | RID | Revision ID | see register description | RO |
| 9–Bh | CC | Class Code | 0C8001h | RO |
| Ch | CLS | Cache Line Size | 00h | RO |
| Dh | MLT | Master Latency Timer | 00h | RO |
| Eh | HTYPE | Header Type | 80h | RO |
| 10–17h | HECI_MBAR | HECI MMIO Base Address | 0000000000 000004h | R/W, RO |
| 2C–2Fh | SS | Sub System Identifiers | 00000000h | R/WO |
| 34h | CAP | Capabilities Pointer | 50h | RO |
| 3C–3Dh | INTR | Interrupt Information | 0100h | R/W, RO |
| 3Eh | MGNT | Minimum Grant | 00h | RO |
| 3Fh | MLAT | Maximum Latency | 00h | RO |
| 40–43h | HFS | Host Firmware Status | 00000000h | RO |
| 50–51h | PID | PCI Power Management Capability ID | 8C01h | RO |
| 52–53h | PC | PCI Power Management Capabilities | C803h | RO |
| 54–55h | PMCS | PCI Power Management Control And Status | 0008h | R/W, RO, R/WC |
| 8C–h8D | MID | Message Signaled Interrupt Identifiers | 0005h | RO |
| 8E–8Fh | MC | Message Signaled Interrupt Message Control | 0080h | R/W, RO |
| 90–93h | MA | Message Signaled Interrupt Message Address | 00000000h | R/W, RO |
| 94–97h | MUA | Message Signaled Interrupt Upper Address (Optional) | 00000000h | R/W |
| 98–99h | MD | Message Signaled Interrupt Message Data | 0000h | R/W |
| A0h | HIDM | HECI Interrupt Delivery Mode | 00h | R/W |



10.2.1 ID— Identifiers

B/D/F/Type: 0/3/1/PCI
 Address Offset: 0-3h
 Default Value: 2E058086h
 Access: RO
 Size: 32 bits

| Bit | Access | Default Value | RST/PWR | Description |
|-------|--------|---------------|---------|-----------------------------------------------------------------------------------------------------|
| 31:16 | RO | 2E05h | Core | Device ID (DID) : Indicates what device number assigned by Intel. |
| 15:0 | RO | 8086h | Core | Vendor ID (VID) : 16-bit field which indicates Intel is the vendor, assigned by the PCI SIG. |

10.2.2 CMD— Command

B/D/F/Type: 0/3/1/PCI
 Address Offset: 4-5h
 Default Value: 0000h
 Access: RO, R/W
 Size: 16 bits

| Bit | Access | Default Value | RST/PWR | Description |
|-------|--------|---------------|---------|-----------------------------------------------------------------------------------------------------------------------------------------------------|
| 15:11 | RO | 00000b | Core | Reserved |
| 10 | R/W | 0b | Core | Interrupt Disable (ID) : Disables this device from generating PCI line based interrupts. This bit does not have any effect on MSI operation. |
| 9 | RO | 0b | Core | Fast Back-to-Back Enable (FBE) : Not implemented, hardwired to 0. |
| 8 | RO | 0b | Core | SERR# Enable (SEE) : Not implemented, hardwired to 0. |
| 7 | RO | 0b | Core | Wait Cycle Enable (WCC) : Not implemented, hardwired to 0. |
| 6 | RO | 0b | Core | Parity Error Response Enable (PEE) : Not implemented, hardwired to 0. |
| 5 | RO | 0b | Core | VGA Palette Snooping Enable (VGA) : Not implemented, hardwired to 0. |
| 4 | RO | 0b | Core | Memory Write and Invalidate Enable (MWIE) : Not implemented, hardwired to 0. |
| 3 | RO | 0b | Core | Special Cycle Enable (SCE) : Not implemented, hardwired to 0. |



| Bit | Access | Default Value | RST/PWR | Description |
|-----|--------|---------------|---------|---------------------------------------------------------------------------------------------------------------------------------------------------------------------------------------------------------------------------------------------------------------------------------------------------------------------------------------------------------------------------------------------------------------------------------------------------------------------------------------------------------------------------------------------------------------------------------------------------------------------------------------------------------------------------------------------------------------------------------------------------------|
| 2 | R/W | 0b | Core | <p>Bus Master Enable (BME): This bit controls the HECI host controller's ability to act as a system memory master for data transfers. When this bit is cleared, HECI bus master activity stops and any active DMA engines return to an idle condition. This bit is made visible to firmware through the H_PCI_CSR register, and changes to this bit may be configured by the H_PCI_CSR register to generate an ME MSI.</p> <p>When this bit is 0, HECI is blocked from generating MSI to the host processor.</p> <p>Note that this bit does not block HECI accesses to ME-UMA (i.e., writes or reads to the host and ME circular buffers through the read window and write window registers still cause ME backbone transactions to ME-UMA).</p> |
| 1 | R/W | 0b | Core | <p>Memory Space Enable (MSE): This bit controls access to the HECI host controller's memory mapped register space.</p> |
| 0 | RO | 0b | Core | <p>I/O Space Enable (IOSE): Not implemented, hardwired to 0.</p> |

10.2.3 STS— Device Status

B/D/F/Type: 0/3/1/PCI
 Address Offset: 6-7h
 Default Value: 0010h
 Access: RO
 Size: 16 bits

| Bit | Access | Default Value | RST/PWR | Description |
|------|--------|---------------|---------|-----------------------------------------------------------------------------------------|
| 15 | RO | 0b | Core | <p>Detected Parity Error (DPE): Not implemented, hardwired to 0.</p> |
| 14 | RO | 0b | Core | <p>Signaled System Error (SSE): Not implemented, hardwired to 0.</p> |
| 13 | RO | 0b | Core | <p>Received Master-Abort (RMA): Not implemented, hardwired to 0.</p> |
| 12 | RO | 0b | Core | <p>Received Target Abort (RTA): Not implemented, hardwired to 0.</p> |
| 11 | RO | 0b | Core | <p>Signaled Target-Abort (STA): Not implemented, hardwired to 0.</p> |
| 10:9 | RO | 00b | Core | <p>DEVSEL# Timing (DEVT): These bits are hardwired to 00.</p> |
| 8 | RO | 0b | Core | <p>Master Data Parity Error Detected (DPD): Not implemented, hardwired to 0.</p> |
| 7 | RO | 0b | Core | <p>Fast Back-to-Back Capable (FBC): Not implemented, hardwired to 0.</p> |
| 6 | RO | 0b | Core | Reserved |
| 5 | RO | 0b | Core | <p>66 MHz Capable (C66): Not implemented, hardwired to 0.</p> |



| Bit | Access | Default Value | RST/PWR | Description |
|-----|--------|---------------|---------|-----------------------------------------------------------------------------------------------|
| 4 | RO | 1b | Core | Capabilities List (CL): Indicates the presence of a capabilities list, hardwired to 1. |
| 3 | RO | 0b | Core | Interrupt Status (IS): Indicates the interrupt status of the device (1 = asserted). |
| 2:0 | RO | 000b | Core | Reserved |

10.2.4 RID—Revision ID

B/D/F/Type: 0/3/1/PCI
 Address Offset: 8h
 Default Value: 02hsee description below
 Access: RO
 Size: 8 bits

| Bit | Access | Default Value | RST/PWR | Description |
|-----|--------|-----------------|---------|----------------------------------------------------------------------------------------------------------------------------------------------------------------------------------------------|
| 7:0 | RO | see description | Core | Revision ID (RID): This field indicates stepping of the HECI host controller. Refer to the <i>Intel® 4 Series Chipset Family Specification Update</i> for the value of this register. |

10.2.5 CC— Class Code

B/D/F/Type: 0/3/1/PCI
 Address Offset: 9-Bh
 Default Value: 0C8001h
 Access: RO
 Size: 24 bits

| Bit | Access | Default Value | RST/PWR | Description |
|-------|--------|---------------|---------|-----------------------------------------------------------------------------------------------------------------------|
| 23:16 | RO | 0ch | Core | Base Class Code (BCC): This field indicates the base class code of the HECI host controller device. |
| 15:8 | RO | 80h | Core | Sub Class Code (SCC): This field indicates the sub class code of the HECI host controller device. |
| 7:0 | RO | 01h | Core | Programming Interface (PI): This field indicates the programming interface of the HECI host controller device. |



10.2.6 CLS— Cache Line Size

B/D/F/Type: 0/3/1/PCI
Address Offset: Ch
Default Value: 00h
Access: RO
Size: 8 bits

| Bit | Access | Default Value | RST/PWR | Description |
|-----|--------|---------------|---------|-----------------------------------------------------------------|
| 7:0 | RO | 00h | Core | Cache Line Size (CLS) : Not implemented, hardwired to 0. |

10.2.7 MLT— Master Latency Timer

B/D/F/Type: 0/3/1/PCI
Address Offset: Dh
Default Value: 00h
Access: RO
Size: 8 bits

| Bit | Access | Default Value | RST/PWR | Description |
|-----|--------|---------------|---------|----------------------------------------------------------------------|
| 7:0 | RO | 00h | Core | Master Latency Timer (MLT) : Not implemented, hardwired to 0. |

10.2.8 HTYPE— Header Type

B/D/F/Type: 0/3/1/PCI
Address Offset: Eh
Default Value: 80h
Access: RO
Size: 8 bits

| Bit | Access | Default Value | RST/PWR | Description |
|-----|--------|---------------|---------|----------------------------------------------------------------------------------------------------------------------|
| 7 | RO | 1b | Core | Multi-Function Device (MFD) : This bit indicates the HECI host controller is part of a multi-function device. |
| 6:0 | RO | 0000000b | Core | Header Layout (HL) : This field indicates that the HECI host controller uses a target device layout. |



10.2.9 HECI_MBAR— HECI MMIO Base Address

B/D/F/Type: 0/3/1/PCI
 Address Offset: 10-17h
 Default Value: 0000000000000004h
 Access: R/W, RO
 Size: 64 bits

This register allocates space for the HECI memory mapped registers.

| Bit | Access | Default Value | RST/PWR | Description |
|------|--------|----------------------|---------|-------------------------------------------------------------------------------------------------------|
| 63:4 | R/W | 000000000 000000h | Core | Base Address (BA): Base address of register memory space. |
| 3 | RO | 0b | Core | Prefetchable (PF): This bit indicates that this range is not pre-fetchable |
| 2:1 | RO | 10b | Core | Type (TP): This field indicates that this range can be mapped anywhere in 32-bit address space |
| 0 | RO | 0b | Core | Resource Type Indicator (RTE): This bit indicates a request for register memory space. |

10.2.10 SS— Sub System Identifiers

B/D/F/Type: 0/3/1/PCI
 Address Offset: 2C-2Fh
 Default Value: 00000000h
 Access: R/WO
 Size: 32 bits

| Bit | Access | Default Value | RST/PWR | Description |
|-------|--------|---------------|---------|----------------------------------------------------------------------------------------------------------------------------------------------------------------------------------------------------------------------------------------------|
| 31:16 | R/WO | 0000h | Core | Subsystem ID (SSID): This field indicates the sub-system identifier. This field should be programmed by BIOS during boot-up. Once written, this register becomes Read Only. This field can only be cleared by PLTRST#. |
| 15:0 | R/WO | 0000h | Core | Subsystem Vendor ID (SSVID): This field indicates the sub-system vendor identifier. This field should be programmed by BIOS during boot-up. Once written, this register becomes Read Only. This field can only be cleared by PLTRST#. |



10.2.11 CAP— Capabilities Pointer

B/D/F/Type: 0/3/1/PCI
Address Offset: 34h
Default Value: 50h
Access: RO
Size: 8 bits

| Bit | Access | Default Value | RST/PWR | Description |
|-----|--------|---------------|---------|----------------------------------------------------------------------------------------------------------------------------------------------------|
| 7:0 | RO | 50h | Core | Capability Pointer (CP): This field indicates the first capability pointer offset. It points to the PCI power management capability offset. |

10.2.12 INTR— Interrupt Information

B/D/F/Type: 0/3/1/PCI
Address Offset: 3C-3Dh
Default Value: 0100h
Access: R/W, RO
Size: 16 bits

| Bit | Access | Default Value | RST/PWR | Description |
|------|--------|---------------|---------|--------------------------------------------------------------------------------------------------------------------------------------------------------------------------------------------------------------------------------------------------------------------------------|
| 15:8 | RO | 01h | Core | Interrupt Pin (IPIN): This field indicates the interrupt pin the HECI host controller uses. The value of 01h selects INTA# interrupt pin. NOTE: As HECI is an internal device in the (G)MCH, the INTA# pin is implemented as an INTA# message to the ICH. |
| 7:0 | R/W | 00h | Core | Interrupt Line (ILINE): Software written value to indicate which interrupt line (vector) the interrupt is connected to. No hardware action is taken on this register. |

10.2.13 MGNT— Minimum Grant

B/D/F/Type: 0/3/1/PCI
Address Offset: 3Eh
Default Value: 00h
Access: RO
Size: 8 bits

| Bit | Access | Default Value | RST/PWR | Description |
|-----|--------|---------------|---------|------------------------------------------------------|
| 7:0 | RO | 00h | Core | Grant (GNT): Not implemented, hardwired to 0. |



10.2.14 MLAT— Maximum Latency

B/D/F/Type: 0/3/1/PCI
 Address Offset: 3Fh
 Default Value: 00h
 Access: RO
 Size: 8 bits

| Bit | Access | Default Value | RST/PWR | Description |
|-----|--------|---------------|---------|--------------------------------------------------------|
| 7:0 | RO | 00h | Core | Latency (LAT): Not implemented, hardwired to 0. |

10.2.15 HFS— Host Firmware Status

B/D/F/Type: 0/3/1/PCI
 Address Offset: 40-43h
 Default Value: 00000000h
 Access: RO
 Size: 32 bits

| Bit | Access | Default Value | RST/PWR | Description |
|------|--------|---------------|---------|----------------------------------------------------------------------------------------------------------------------------------------------------------------------------------------------------------------------------|
| 31:0 | RO | 00000000h | Core | Firmware Status Host Access (FS_HA): This field indicates current status of the firmware for the HECI controller. This field is the host's read only access to the FS field in the ME Firmware Status AUX register. |

10.2.16 PID— PCI Power Management Capability ID

B/D/F/Type: 0/3/1/PCI
 Address Offset: 50-51h
 Default Value: 8C01h
 Access: RO
 Size: 16 bits

| Bit | Access | Default Value | RST/PWR | Description |
|------|--------|---------------|---------|---------------------------------------------------------------------------------------------------------------------------------------------------------------|
| 15:8 | RO | 8Ch | Core | Next Capability (NEXT): This field indicates the location of the next capability item in the list. This is the Message Signaled Interrupts capability. |
| 7:0 | RO | 01h | Core | Cap ID (CID): This field indicates that this pointer is a PCI power management. |



10.2.17 PC— PCI Power Management Capabilities

B/D/F/Type: 0/3/1/PCI
 Address Offset: 52-53h
 Default Value: C803h
 Access: RO
 Size: 16 bits

| Bit | Access | Default Value | RST/PWR | Description |
|-------|--------|---------------|---------|---------------------------------------------------------------------------------------------------------------------------------------------------------------------------|
| 15:11 | RO | 11001b | Core | PME_Support (PSUP): This field indicates the states that can generate PME#. HECI can assert PME# from any D-state except D1 or D2 which are not supported by HECI. |
| 10 | RO | 0b | Core | D2_Support (D2S): The D2 state is not supported for the HECI host controller. |
| 9 | RO | 0b | Core | D1_Support (D1S): The D1 state is not supported for the HECI host controller. |
| 8:6 | RO | 000b | Core | Aux_Current (AUXC): This field reports the maximum Suspend well current required when in the D3COLD state. |
| 5 | RO | 0b | Core | Device Specific Initialization (DSI): This bit indicates whether device-specific initialization is required. |
| 4 | RO | 0b | Core | Reserved |
| 3 | RO | 0b | Core | PME Clock (PMEC): This bit indicates that PCI clock is not required to generate PME#. |
| 2:0 | RO | 011b | Core | Version (VS): Indicates support for the <i>PCI Power Management Specification, Revision 1.2</i> . |



10.2.18 PMCS— PCI Power Management Control And Status

B/D/F/Type: 0/3/1/PCI
 Address Offset: 54-55h
 Default Value: 0008h
 Access: R/W, RO, R/WC
 Size: 16 bits

| Bit | Access | Default Value | RST/PWR | Description |
|------|--------|---------------|---------|-----------------------------------------------------------------------------------------------------------------------------------------------------------------------------------------------------------------------------------------------------------------------------------------------------------------------------------------------------------------------------------------------------------------------------------------------------------------------------------------------------------------------------------------------------------------------------------------------------------------|
| 15 | R/WC | 0b | Core | <p>PME Status (PMES): The PME Status bit in HECI space can be set to 1 by ARC FW performing a write into AUX register to set PMES.</p> <p>This bit is cleared by host processor writing a 1 to it. ARC cannot clear this bit.</p> <p>Host processor writes with value 0 have no effect on this bit.</p> <p>This bit is reset to 0 by MRST#.</p> |
| 14:9 | RO | 000000b | Core | Reserved. |
| 8 | R/W | 0b | Core | <p>PME Enable (PMEE): This bit is read/write, under control of host software. It does not directly have an effect on PME events. However, this bit is shadowed into AUX space so ARC FW can monitor it. The ARC FW is responsible for ensuring that FW does not cause the PME-S bit to transition to 1 while the PMEE bit is 0, indicating that host SW had disabled PME.</p> <p>This bit is reset to 0 by MRST#.</p> |
| 7:4 | RO | 0000b | Core | Reserved |
| 3 | RO | 1b | Core | <p>No_Soft_Reset (NSR): This bit indicates that when the HECI host controller is transitioning from D3hot to D0 due to power state command, it does not perform an internal reset. Configuration context is Reserved.</p> |
| 2 | RO | 0b | Core | Reserved |
| 1:0 | R/W | 00b | Core | <p>Power State (PS): This field is used both to determine the current power state of the HECI host controller and to set a new power state. The values are:</p> <p>00 = D0 state 11 = D3HOT state</p> <p>The D1 and D2 states are not supported for this HECI host controller. When in the D3HOT state, the HBA's configuration space is available, but the register memory spaces are not. Additionally, interrupts are blocked. This field is visible to firmware through the H_PCI_CSR register, and changes to this field may be configured by the H_PCI_CSR register to generate an ME MSI.</p> |



10.2.19 MID— Message Signaled Interrupt Identifiers

B/D/F/Type: 0/3/1/PCI
Address Offset: 8C-8Dh
Default Value: 0005h
Access: RO
Size: 16 bits

| Bit | Access | Default Value | RST/PWR | Description |
|------|--------|---------------|---------|-------------------------------------------------------------------------------------------------------------------------------------------------------------------------------------------|
| 15:8 | RO | 00h | Core | Next Pointer (NEXT) : This field indicates the next item in the list. This can be other capability pointers (such as PCI-X or PCI-Express) or it can be the last item in the list. |
| 7:0 | RO | 05h | Core | Capability ID (CID) : Capabilities ID indicates MSI. |

10.2.20 MC— Message Signaled Interrupt Message Control

B/D/F/Type: 0/3/1/PCI
Address Offset: 8E-8Fh
Default Value: 0080h
Access: R/W, RO
Size: 16 bits

| Bit | Access | Default Value | RST/PWR | Description |
|------|--------|---------------|---------|-----------------------------------------------------------------------------------------------------------------------|
| 15:8 | RO | 00h | Core | Reserved |
| 7 | RO | 1b | Core | 64 Bit Address Capable (C64) : Specifies whether capable of generating 64-bit messages. |
| 6:4 | RO | 000b | Core | Multiple Message Enable (MME) : Not implemented, hardwired to 0. |
| 3:1 | RO | 000b | Core | Multiple Message Capable (MMC) : Not implemented, hardwired to 0. |
| 0 | R/W | 0b | Core | MSI Enable (MSIE) : If set, MSI is enabled and traditional interrupt pins are not used to generate interrupts. |

10.2.21 MA— Message Signaled Interrupt Message Address

B/D/F/Type: 0/3/1/PCI
Address Offset: 90-93h
Default Value: 00000000h
Access: R/W, RO
Size: 32 bits

| Bit | Access | Default Value | RST/PWR | Description |
|------|--------|---------------|---------|---------------------------------------------------------------------------------------------------|
| 31:2 | R/W | 00000000h | Core | Address (ADDR) : Lower 32 bits of the system specified message address, always DW aligned. |
| 1:0 | RO | 00b | Core | Reserved |

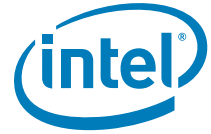

10.2.22 MUA— Message Signaled Interrupt Upper Address (Optional)

B/D/F/Type: 0/3/1/PCI
 Address Offset: 94-97h
 Default Value: 00000000h
 Access: R/W
 Size: 32 bits

| Bit | Access | Default Value | RST/PWR | Description |
|------|--------|---------------|---------|--------------------------------------------------------------------------------------------------------------------------------------------------|
| 31:0 | R/W | 00000000h | Core | Upper Address (UADDR): Upper 32 bits of the system specified message address. This register is optional and only implemented if MC.C64=1. |

10.2.23 MD— Message Signaled Interrupt Message Data

B/D/F/Type: 0/3/1/PCI
 Address Offset: 98-99h
 Default Value: 0000h
 Access: R/W
 Size: 16 bits

| Bit | Access | Default Value | RST/PWR | Description |
|------|--------|---------------|---------|-----------------------------------------------------------------------------------------------------------------------------------------------------------------------------------------|
| 15:0 | R/W | 0000h | Core | Data (Data): This 16-bit field is programmed by system software if MSI is enabled. Its content is driven onto the FSB during the data phase of the MSI memory write transaction. |

10.2.24 HIDM—HECI Interrupt Delivery Mode

B/D/F/Type: 0/3/1/PCI
 Address Offset: A0h
 Default Value: 00h
 Access: R/W
 Size: 8 bits
 BIOS Optimal Default 00h

This register is used to select interrupt delivery mechanism for HECI to Host processor interrupts.

| Bit | Access | Default Value | RST/PWR | Description |
|-----|--------|---------------|---------|--------------------------------------------------------------------------------------------------------------------------------------------------------------------------------------------------------------------------------------------------------------------------------|
| 7:2 | RO | 0h | | Reserved |
| 1:0 | R/W | 00b | Core | HECI Interrupt Delivery Mode (HIDM): These bits control what type of interrupt the HECI will send when ARC writes to set the M_IG bit in AUX space. They are interpreted as follows: 00 = Generate Legacy or MSI interrupt 01 = Generate SCI 10 = Generate SMI |



10.3 HECI PCI MMIO Space Registers

Table 19. HECI PCI MMIO space Register Address Map

| Address Offset | Register Symbol | Register Name | Default Value | Access |
|----------------|-----------------|-----------------------------------|---------------|---------------|
| 0–3h | H_CB_WW | Host Circular Buffer Write Window | 00000000h | W |
| 4–7h | H_CSR | Host Control Status | 02000000h | RO, R/W, R/WC |
| 8–Bh | ME_CB_RW | ME Circular Buffer Read Window | FFFFFFFFh | RO |
| C–Fh | ME_CSR_HA | ME Control Status Host Access | 02000000h | RO |

10.3.1 H_CB_WW— Host Circular Buffer Write Window

B/D/F/Type: 0/3/0/MMIO
 Address Offset: 0-3h
 Default Value: 00000000h
 Access: W
 Size: 32 bits

This register is for host to write into its Circular Buffer (H_CB). The host's circular buffer is located at the ME subsystem address specified in the Host CB Base Address register.

| Bit | Access | Default Value | RST/PWR | Description |
|------|--------|---------------|---------|---------------------------------------------------------------------------------------------------------------------------------------------------------------------------------------------------------------------------------------------------------------------------------------------------------------------------------------------------------------------------------------------------------------------------------------------------------------------------------------------------------|
| 31:0 | W | 00000000h | Core | Host Circular Buffer Write Window Field (H_CB_WWF): This bit field is for host to write into its circular buffer. The host's circular buffer is located at the ME subsystem address specified in the Host CB Base Address register. This field is write only, reads will return arbitrary data. Writes to this register will increment the H_CBWP as long as ME_RDY is 1. When ME_RDY is 0, writes to this register have no effect and are not delivered to the H_CB, nor is H_CBWP incremented. |

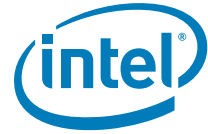

10.3.2 H_CSR— Host Control Status

B/D/F/Type: 0/3/0/MMIO
 Address Offset: 4-7h
 Default Value: 02000000h
 Access: RO, R/W, R/WC
 Size: 32 bits

This register reports status information about the host circular buffer (H_CB) and allows host software to control interrupt generation. Note to software: reserved bits in this register must be set to 0 whenever this register is written.

| Bit | Access | Default Value | RST/PWR | Description |
|-------|--------|---------------|---------|--------------------------------------------------------------------------------------------------------------------------------------------------------------------------------------------------------------------------------------------------------------------------------------------------------------------------------------------------------------------------------------------------------------------------------------------------------------------------------------------------------------------------------------------------------------------------------------------------------------------------------------------------------------------------------------------------------------------------------------------------------------------------------------------------------------------------------------------------------------------|
| 31:24 | RO | 02h | Core | <p>Host Circular Buffer Depth (H_CBD): This field indicates the maximum number of 32 bit entries available in the host circular buffer (H_CB). Host software uses this field along with the H_CBRP and H_CBWP fields to calculate the number of valid entries in the H_CB to read or number of entries available for write. This field is a read only version of H_CBD_MERWA field which is programmed by the ME firmware during ME initialization.</p> <p>Programmer's note: This field is implemented with a "1-hot" scheme. Only one bit will be set to a 1 at a time. Each bit position represents the value n of a buffer depth of (2^n). For example, when bit 1 is 1, the buffer depth is 2; when bit 2 is 1, the buffer depth is 4, etc. The allowed buffer depth values are 2, 4, 8, 16, 32, 64 and 128. This field is reset by MERST#.</p> |
| 23:16 | RO | 00h | Core | <p>Host CB Write Pointer (H_CBWP): This field points to next location in the H_CB for host to write the data. Software uses this field along with H_CBRP and H_CBD fields to calculate the number of valid entries in the H_CB to read or number of entries available for write.</p> |
| 15:8 | RO | 00h | Core | <p>Host CB Read Pointer (H_CBRP): This field points to next location in the H_CB where a valid data is available for embedded controller to read. Software uses this field along with H_CBWP and H_CBD fields to calculate the number of valid entries in the host CB to read or number of entries available for write.</p> |
| 7:5 | RO | 000b | Core | Reserved |
| 4 | R/W | 0b | Core | <p>Host Reset (H_RST): Setting this bit to 1 will initiate a HECI reset sequence to get the circular buffers into a known good state for host and ME communication. When this bit transitions from 0-to-1, hardware will clear the H_RDY and ME_RDY bits.</p> |
| 3 | R/W | 0b | Core | <p>Host Ready (H_RDY): This bit indicates that the host is ready to process messages.</p> |



| Bit | Access | Default Value | RST/PWR | Description |
|-----|--------|---------------|---------|------------------------------------------------------------------------------------------------------------------------------------------------------------------------------------------------------------------------------------------------------------------------------------------------------------------------------|
| 2 | R/W | 0b | Core | Host Interrupt Generate (H_IG): Once message(s) are written into its CB, the host sets this bit to 1 for the hardware to set the ME_IS bit in the ME_CSR and to generate an interrupt message to ME. Hardware will send the interrupt message to ME only if the ME_IE is enabled. Hardware then clears this bit to 0. |
| 1 | R/WC | 0b | Core | Host Interrupt Status (H_IS): Hardware sets this bit to 1 when ME_IG bit is set to 1. Host clears this bit to 0 by writing a 1 to this bit position. H_IE has no effect on this bit. |
| 0 | R/W | 0b | Core | Host Interrupt Enable (H_IE): Host sets this bit to 1 to enable the host interrupt (INTR# or MSI) to be asserted when H_IS is set to 1. |

10.3.3 ME_CB_RW— ME Circular Buffer Read Window

B/D/F/Type: 0/3/0/MMIO
 Address Offset: 8-Bh
 Default Value: FFFFFFFFh
 Access: RO
 Size: 32 bits

This register is for host to read from the ME Circular Buffer (ME_CB). The ME's circular buffer is located at the ME subsystem address specified in the ME CB Base Address register.

| Bit | Access | Default Value | RST/PWR | Description |
|------|--------|---------------|---------|--------------------------------------------------------------------------------------------------------------------------------------------------------------------------------------------------------------------------------------------------------------------------------------------------------------------------------------------------------------------------------------------------------------------------------------------------------------------------------|
| 31:0 | RO | FFFFFFFh | Core | ME Circular Buffer Read Window Field (ME_CB_RWF): This bit field is for host to read from the ME Circular Buffer. The ME's circular buffer is located at the ME subsystem address specified in the ME CB Base Address register. This field is read only, writes have no effect. Reads to this register will increment the ME_CBRP as long as ME_RDY is 1. When ME_RDY is 0, reads to this register have no effect, all 1s are returned, and ME_CBRP is not incremented. |



10.3.4 ME_CSR_HA— ME Control Status Host Access

B/D/F/Type: 0/3/0/MMIO
 Address Offset: C-Fh
 Default Value: 02000000h
 Access: RO
 Size: 32 bits

This register allows host software to read the ME Control Status register (ME_CSR).
 This register is reset by MERST#.

| Bit | Access | Default Value | RST/PWR | Description |
|-------|--------|---------------|---------|-------------------------------------------------------------------------------------------------|
| 31:24 | RO | 02h | Core | ME Circular Buffer Depth Host Read Access (ME_CBD_HRA): Host read only access to ME_CBD. |
| 23:16 | RO | 00h | Core | ME CB Write Pointer Host Read Access (ME_CBWP_HRA): Host read only access to ME_CBWP. |
| 15:8 | RO | 00h | Core | ME CB Read Pointer Host Read Access (ME_CBRP_HRA): Host read only access to ME_CBRP. |
| 7:5 | RO | 000b | Core | Reserved |
| 4 | RO | 0b | Core | ME Reset Host Read Access (ME_RST_HRA): Host read access to ME_RST. |
| 3 | RO | 0b | Core | ME Ready Host Read Access (ME_RDY_HRA): Host read access to ME_RDY. |
| 2 | RO | 0b | Core | ME Interrupt Generate Host Read Access (ME_IG_HRA): Host read only access to ME_IG. |
| 1 | RO | 0b | Core | ME Interrupt Status Host Read Access (ME_IS_HRA): Host read only access to ME_IS. |
| 0 | RO | 0b | Core | ME Interrupt Enable Host Read Access (ME_IE_HRA): Host read only access to ME_IE. |



10.4 Second HECI Function MMIO Space Registers

Table 20. Second HECI function MMIO Space Register Address Map

| Address Offset | Register Symbol | Register Name | Default Value | Access |
|----------------|-----------------|-----------------------------------|---------------|---------------|
| 0–3h | H_CB_WW | Host Circular Buffer Write Window | 00000000h | W |
| 4–7h | H_CSR | Host Control Status | 02000000h | RO, R/W, R/WC |
| 8–Bh | ME_CB_RW | ME Circular Buffer Read Window | FFFFFFFFh | RO |
| C–Fh | ME_CSR_HA | ME Control Status Host Access | 02000000h | RO |

10.4.1 H_CB_WW— Host Circular Buffer Write Window

B/D/F/Type: 0/3/1/MMIO
 Address Offset: 0-3h
 Default Value: 00000000h
 Access: W
 Size: 32 bits

This register is for host to write into its Circular Buffer (H_CB). The host’s circular buffer is located at the ME subsystem address specified in the Host CB Base Address register.

| Bit | Access | Default Value | RST/PWR | Description |
|------|--------|---------------|---------|---------------------------------------------------------------------------------------------------------------------------------------------------------------------------------------------------------------------------------------------------------------------------------------------------------------------------------------------------------------------------------------------------------------------------------------------------------------------------------------------------------|
| 31:0 | W | 00000000h | Core | Host Circular Buffer Write Window Field (H_CB_WWF): This bit field is for host to write into its circular buffer. The host’s circular buffer is located at the ME subsystem address specified in the Host CB Base Address register. This field is write only, reads will return arbitrary data. Writes to this register will increment the H_CBWP as long as ME_RDY is 1. When ME_RDY is 0, writes to this register have no effect and are not delivered to the H_CB, nor is H_CBWP incremented. |

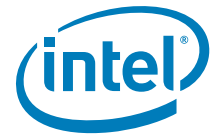

10.4.2 H_CSR— Host Control Status

B/D/F/Type: 0/3/1/MMIO
 Address Offset: 4-7h
 Default Value: 02000000h
 Access: RO, R/W, R/WC
 Size: 32 bits

This register reports status information about the host circular buffer (H_CB) and allows host software to control interrupt generation.

Note: Reserved bits in this register must be set to 0 whenever this register is written.

| Bit | Access | Default Value | RST/PWR | Description |
|-------|--------|---------------|---------|--------------------------------------------------------------------------------------------------------------------------------------------------------------------------------------------------------------------------------------------------------------------------------------------------------------------------------------------------------------------------------------------------------------------------------------------------------------------------------------------------------------------------------------------------------------------------------------------------------------------------------------------------------------------------------------------------------------------------------------------------------------------------------------------------------------------------------------------------------------------|
| 31:24 | RO | 02h | Core | <p>Host Circular Buffer Depth (H_CBD): This field indicates the maximum number of 32 bit entries available in the host circular buffer (H_CB). Host software uses this field along with the H_CBRP and H_CBWP fields to calculate the number of valid entries in the H_CB to read or number of entries available for write. This field is a read only version of H_CBD_MERWA field which is programmed by the ME firmware during ME initialization.</p> <p>Programmer's note: This field is implemented with a "1-hot" scheme. Only one bit will be set to a 1 at a time. Each bit position represents the value n of a buffer depth of (2^n). For example, when bit 0 is 1, the buffer depth is 1; when bit 1 is 1, the buffer depth is 2, etc. The allowed buffer depth values are 2, 4, 8, 16, 32, 64 and 128. This field is reset by MERST#.</p> |
| 23:16 | RO | 00h | Core | <p>Host CB Write Pointer (H_CBWP): This field points to next location in the H_CB for host to write the data. Software uses this field along with H_CBRP and H_CBD fields to calculate the number of valid entries in the H_CB to read or number of entries available for write.</p> |
| 15:8 | RO | 00h | Core | <p>Host CB Read Pointer (H_CBRP): This field points to next location in the H_CB where a valid data is available for embedded controller to read. Software uses this field along with H_CBWP and H_CBD fields to calculate the number of valid entries in the host CB to read or number of entries available for write.</p> |
| 7:5 | RO | 000b | Core | Reserved |
| 4 | R/W | 0b | Core | <p>Host Reset (H_RST): Setting this bit to 1 will initiate a HECI reset sequence to get the circular buffers into a known good state for host and ME communication. When this bit transitions from 0 to 1, hardware will clear the H_RDY and ME_RDY bits.</p> |
| 3 | R/W | 0b | Core | <p>Host Ready (H_RDY): This bit indicates that the host is ready to process messages.</p> |



| Bit | Access | Default Value | RST/PWR | Description |
|-----|--------|---------------|---------|------------------------------------------------------------------------------------------------------------------------------------------------------------------------------------------------------------------------------------------------------------------------------------------------------------------------------|
| 2 | R/W | 0b | Core | Host Interrupt Generate (H_IG): Once message(s) are written into its CB, the host sets this bit to 1 for the hardware to set the ME_IS bit in the ME_CSR and to generate an interrupt message to ME. Hardware will send the interrupt message to ME only if the ME_IE is enabled. Hardware then clears this bit to 0. |
| 1 | R/WC | 0b | Core | Host Interrupt Status (H_IS): Hardware sets this bit to 1 when ME_IG bit is set to 1. Host clears this bit to 0 by writing a 1 to this bit position. H_IE has no effect on this bit. |
| 0 | R/W | 0b | Core | Host Interrupt Enable (H_IE): The Host sets this bit to 1 to enable the host interrupt (INTR# or MSI) to be asserted when H_IS is set to 1. |

10.4.3 ME_CB_RW— ME Circular Buffer Read Window

B/D/F/Type: 0/3/1/MMIO
 Address Offset: 8-Bh
 Default Value: FFFFFFFFh
 Access: RO
 Size: 32 bits

This register is for host to read from the ME Circular Buffer (ME_CB). The ME's circular buffer is located at the ME subsystem address specified in the ME CB Base Address register.

| Bit | Access | Default Value | RST/PWR | Description |
|------|--------|---------------|---------|--------------------------------------------------------------------------------------------------------------------------------------------------------------------------------------------------------------------------------------------------------------------------------------------------------------------------------------------------------------------------------------------------------------------------------------------------------------------------------|
| 31:0 | RO | FFFFFFFh | Core | ME Circular Buffer Read Window Field (ME_CB_RWF): This bit field is for host to read from the ME Circular Buffer. The ME's circular buffer is located at the ME subsystem address specified in the ME CB Base Address register. This field is read only, writes have no effect. Reads to this register will increment the ME_CBRP as long as ME_RDY is 1. When ME_RDY is 0, reads to this register have no effect, all 1s are returned, and ME_CBRP is not incremented. |



10.4.4 ME_CSR_HA— ME Control Status Host Access

B/D/F/Type: 0/3/1/MMIO
 Address Offset: C-Fh
 Default Value: 02000000h
 Access: RO
 Size: 32 bits

This register allows host software to read the ME Control Status register (ME_CSR).
 This register is reset by MERST#.

| Bit | Access | Default Value | RST/PWR | Description |
|-------|--------|---------------|---------|-------------------------------------------------------------------------------------------------|
| 31:24 | RO | 02h | Core | ME Circular Buffer Depth Host Read Access (ME_CBD_HRA): Host read only access to ME_CBD. |
| 23:16 | RO | 00h | Core | ME CB Write Pointer Host Read Access (ME_CBWP_HRA): Host read only access to ME_CBWP. |
| 15:8 | RO | 00h | Core | ME CB Read Pointer Host Read Access (ME_CBRP_HRA): Host read only access to ME_CBRP. |
| 7:5 | RO | 000b | Core | Reserved |
| 4 | RO | 0b | Core | ME Reset Host Read Access (ME_RST_HRA): Host read access to ME_RST. |
| 3 | RO | 0b | Core | ME Ready Host Read Access (ME_RDY_HRA): Host read access to ME_RDY. |
| 2 | RO | 0b | Core | ME Interrupt Generate Host Read Access (ME_IG_HRA): Host read only access to ME_IG. |
| 1 | RO | 0b | Core | ME Interrupt Status Host Read Access (ME_IS_HRA): Host read only access to ME_IS. |
| 0 | RO | 0b | Core | ME Interrupt Enable Host Read Access (ME_IE_HRA): Host read only access to ME_IE. |

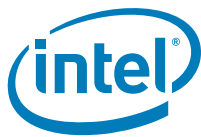

10.5 IDE Function for Remote Boot and Installations PT IDER Registers

Table 21. IDE Function for remote boot and Installations PT IDER Register Address Map

| Address Offset | Register Symbol | Register Name | Default Value | Access |
|----------------|-----------------|--------------------------------------------------|--------------------------|---------------|
| 0–3h | ID | Identification | 2E068086h | RO |
| 4–5h | CMD | Command Register | 0000h | RO, R/W |
| 6–7h | STS | Device Status | 00B0h | RO |
| 8h | RID | Revision ID | see register description | RO |
| 9–Bh | CC | Class Codes | 010185h | RO |
| Ch | CLS | Cache Line Size | 00h | RO |
| Dh | MLT | Master Latency Timer | 00h | RO |
| 10–13h | PCMDBA | Primary Command Block IO Bar | 00000001h | RO, R/W |
| 14–17h | PCTLBA | Primary Control Block Base Address | 00000001h | RO, R/W |
| 18–1Bh | SCMDBA | Secondary Command Block Base Address | 00000001h | RO, R/W |
| 1C–1Fh | SCTLBA | Secondary Control Block base Address | 00000001h | RO, R/W |
| 20–23h | LBAR | Legacy Bus Master Base Address | 00000001h | RO, R/W |
| 2C–2Fh | SS | Sub System Identifiers | 00008086h | R/WO |
| 30–33h | EROM | Expansion ROM Base Address | 00000000h | RO |
| 34h | CAP | Capabilities Pointer | C8h | RO |
| 3C–3Dh | INTR | Interrupt Information | 0300h | R/W, RO |
| 3Eh | MGNT | Minimum Grant | 00h | RO |
| 3Fh | MLAT | Maximum Latency | 00h | RO |
| C8–C9h | PID | PCI Power Management Capability ID | D001h | RO |
| CA–CBh | PC | PCI Power Management Capabilities | 0023h | RO |
| CC–CFh | PMCS | PCI Power Management Control and Status | 00000000h | RO, R/W, RO/V |
| D0–D1h | MID | Message Signaled Interrupt Capability ID | 0005h | RO |
| D2–D3h | MC | Message Signaled Interrupt Message Control | 0080h | RO, R/W |
| D4–D7h | MA | Message Signaled Interrupt Message Address | 00000000h | R/W, RO |
| D8–DBh | MAU | Message Signaled Interrupt Message Upper Address | 00000000h | RO, R/W |
| DC–DDh | MD | Message Signaled Interrupt Message Data | 0000h | R/W |



10.5.1 ID—Identification

B/D/F/Type: 0/3/2/PCI
 Address Offset: 0-3h
 Default Value: 2E068086h
 Access: RO
 Size: 32 bits

This register, combined with the Device Identification register, uniquely identifies any PCI device.

| Bit | Access | Default Value | RST/PWR | Description |
|-------|--------|---------------|---------|-----------------------------------------------------------------------------------------------------|
| 31:16 | RO | 2E06h | Core | Device ID (DID) : Assigned by Manufacturer, identifies the type of Device |
| 15:0 | RO | 8086h | Core | Vendor ID (VID) : 16-bit field which indicates Intel is the vendor, assigned by the PCI SIG. |

10.5.2 CMD—Command Register

B/D/F/Type: 0/3/2/PCI
 Address Offset: 4-5h
 Default Value: 0000h
 Access: RO, R/W
 Size: 16 bits

Reset: Host System reset or D3->D0 transition of function.

This register provides basic control over the device's ability to respond to and perform Host system related accesses.

| Bit | Access | Default Value | RST/PWR | Description |
|-------|--------|---------------|---------|-----------------------------------------------------------------------------------------------------------------------------------------------------------------------------------------------------------------------------------------------------------------------------------------|
| 15:11 | RO | 00h | Core | Reserved |
| 10 | R/W | 0b | Core | Interrupt Disable (ID) : This disables pin-based INTx# interrupts. This bit has no effect on MSI operation. When set, internal INTx# messages will not be generated. When cleared, internal INTx# messages are generated if there is an interrupt and MSI is not enabled. |
| 9 | RO | 0b | Core | Fast back-to-back enable (FBE) : Reserved |
| 8 | RO | 0b | Core | SERR# Enable (SEE) : The PT function never generates an SERR#. Reserved |
| 7 | RO | 0b | Core | Wait Cycle Enable (WCC) : Reserved |
| 6 | RO | 0b | Core | Parity Error Response Enable (PEE) : No Parity detection in PT functions. Reserved |
| 5 | RO | 0b | Core | VGA Palette Snooping Enable (VGA) : Reserved |
| 4 | RO | 0b | Core | Memory Write and Invalidate Enable (MWIE) : Reserved |
| 3 | RO | 0b | Core | Special Cycle enable (SCE) : Reserved |



| Bit | Access | Default Value | RST/PWR | Description |
|-----|--------|---------------|---------|-----------------------------------------------------------------------------------------------------------------------------------------------------------------------------------------------------------|
| 2 | R/W | 0b | Core | Bus Master Enable (BME): This bit controls the PT function's ability to act as a master for data transfers. This bit does not impact the generation of completions for split transaction commands. |
| 1 | RO | 0b | Core | Memory Space Enable (MSE): PT function does not contain target memory space. |
| 0 | R/W | 0b | Core | I/O Space enable (IOSE): This bit controls access to the PT function's target I/O space. |

10.5.3 STS—Device Status

B/D/F/Type: 0/3/2/PCI
 Address Offset: 6-7h
 Default Value: 00B0h
 Access: RO
 Size: 16 bits

This register is used by the function to reflect its PCI status to the host for the functionality that it implements.

| Bit | Access | Default Value | RST/PWR | Description |
|------|--------|---------------|---------|--------------------------------------------------------------------------------------------------------------------------------------------------------------------------------------------------------------------------------------------------------|
| 15 | RO | 0b | Core | Detected Parity Error (DPE): No parity error on its interface. |
| 14 | RO | 0b | Core | Signaled System Error (SSE): The PT function will never generate an SERR#. |
| 13 | RO | 0b | Core | Received Master-Abort Status (RMA): Reserved |
| 12 | RO | 0b | Core | Received Target-Abort Status (RTA): Reserved |
| 11 | RO | 0b | Core | Signaled Target-Abort Status (STA): The PT Function will never generate a target abort. Reserved |
| 10:9 | RO | 00b | Core | DEVSEL# Timing Status (DEVT): This bit controls the device select time for the PT function's PCI interface. |
| 8 | RO | 0b | Core | Master Data Parity Error Detected (DPD): PT function (IDER), as a master, does not detect a parity error. Other PT function is not a master and hence this bit is reserved also. |
| 7 | RO | 1b | Core | Fast back to back capable: Reserved |
| 6 | RO | 0b | Core | Reserved |
| 5 | RO | 1b | Core | 66MHz capable: Reserved |
| 4 | RO | 1b | Core | Capabilities List (CL): This bit indicates that there is a capabilities pointer implemented in the device. |
| 3 | RO | 0b | Core | Interrupt Status (IS): This bit reflects the state of the interrupt in the function. Setting of the Interrupt Disable bit to 1 has no affect on this bit. Only when this bit is a 1 and ID bit is 0 is the INTc interrupt asserted to the Host. |
| 2:0 | RO | 000b | Core | Reserved |



10.5.4 RID—Revision ID

B/D/F/Type: 0/3/2/PCI
 Address Offset: 8h
 Default Value: 02hsee description below
 Access: RO
 Size: 8 bits

This register specifies a device specific revision.

| Bit | Access | Default Value | RST/PWR | Description |
|-----|--------|-----------------|---------|-----------------------------------------------------------------------------------------------------------------------------|
| 7:0 | RO | see description | Core | Revision ID. Refer to the <i>Intel® 4 Series Chipset Family Specification Update</i> for the value of this register. |

10.5.5 CC—Class Codes

B/D/F/Type: 0/3/2/PCI
 Address Offset: 9-Bh
 Default Value: 010185h
 Access: RO
 Size: 24 bits

This register identifies the basic functionality of the device ie IDE mass storage.

| Bit | Access | Default Value | RST/PWR | Description |
|------|--------|---------------|---------|----------------------------------------------------|
| 23:0 | RO | 010185h | Core | Programming Interface BCC SCC (PI BCC SCC): |

10.5.6 CLS—Cache Line Size

B/D/F/Type: 0/3/2/PCI
 Address Offset: Ch
 Default Value: 00h
 Access: RO
 Size: 8 bits

This register defines the system cache line size in DWORD increments. Mandatory for master which use the Memory-Write and Invalidate command.

| Bit | Access | Default Value | RST/PWR | Description |
|-----|--------|---------------|---------|------------------------------------------------------------------------------|
| 7:0 | RO | 00h | Core | Cache Line Size (CLS): All writes to system memory are Memory Writes. |



10.5.7 MLT—Master Latency Timer

B/D/F/Type: 0/3/2/PCI
 Address Offset: Dh
 Default Value: 00h
 Access: RO
 Size: 8 bits

This register defines the minimum number of PCI clocks the bus master can retain ownership of the bus whenever it initiates new transactions.

| Bit | Access | Default Value | RST/PWR | Description |
|-----|--------|---------------|---------|-------------------------------------------------------------------------------------|
| 7:0 | RO | 00h | Core | Master Latency Timer (MLT): Not implemented since the function is in (G)MCH. |

10.5.8 PCMDBA—Primary Command Block IO Bar

B/D/F/Type: 0/3/2/PCI
 Address Offset: 10-13h
 Default Value: 00000001h
 Access: RO, R/W
 Size: 32 bits

Reset: Host system Reset or D3->D0 transition of the function

This 8-byte I/O space is used in Native Mode for the Primary Controller's Command Block ie BAR0

| Bit | Access | Default Value | RST/PWR | Description |
|-------|--------|---------------|---------|----------------------------------------------------------------------------------------------|
| 31:16 | RO | 0000h | Core | Reserved |
| 15:3 | R/W | 0000h | Core | Base Address (BAR): Base Address of the BAR0 I/O space (8 consecutive I/O locations). |
| 2:1 | RO | 00b | Core | Reserved |
| 0 | RO | 1b | Core | Resource Type Indicator (RTE): This bit indicates a request for I/O space. |

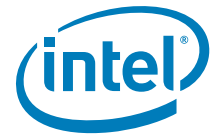

10.5.9 PCTLBA—Primary Control Block Base Address

B/D/F/Type: 0/3/2/PCI
 Address Offset: 14-17h
 Default Value: 00000001h
 Access: RO, R/W
 Size: 32 bits

Reset: Host system Reset or D3->D0 transition of the function

This 4-byte I/O space is used in Native Mode for the Primary Controller's Control Block ie BAR1

| Bit | Access | Default Value | RST/PWR | Description |
|-------|--------|---------------|---------|----------------------------------------------------------------------------------------------|
| 31:16 | RO | 0000h | Core | Reserved |
| 15:2 | R/W | 0000h | Core | Base Address (BAR) : Base Address of the BAR1 I/O space (4 consecutive I/O locations) |
| 1 | RO | 0b | Core | Reserved |
| 0 | RO | 1b | Core | Resource Type Indicator (RTE) : This bit indicates a request for I/O space |

10.5.10 SCMDBA—Secondary Command Block Base Address

B/D/F/Type: 0/3/2/PCI
 Address Offset: 18-1Bh
 Default Value: 00000001h
 Access: RO, R/W
 Size: 32 bits

Reset: Host System Reset or D3->D0 transition of the function

This 8-byte I/O space is used in Native Mode for the secondary Controller's Command Block. Secondary Channel is not implemented and reads return 7F7F7F7Fh and all writes are ignored.

| Bit | Access | Default Value | RST/PWR | Description |
|-------|--------|---------------|---------|------------------------------------------------------------------------------------------|
| 31:16 | RO | 0000h | Core | Reserved |
| 15:3 | R/W | 0000h | Core | Base Address (BAR) : Base Address of the I/O space (8 consecutive I/O locations). |
| 2:1 | RO | 00b | Core | Reserved |
| 0 | RO | 1b | Core | Resource Type Indicator (RTE) : This bit indicates a request for I/O space. |



10.5.11 SCTLBA—Secondary Control Block base Address

B/D/F/Type: 0/3/2/PCI
 Address Offset: 1C-1Fh
 Default Value: 00000001h
 Access: RO, R/W
 Size: 32 bits

Reset: Host System Reset or D3->D0 transition

This 4-byte I/O space is used in Native Mode for Secondary Controller's Control block. Secondary Channel is not implemented and reads return 7F7F7F7Fh and all writes are ignored.

| Bit | Access | Default Value | RST/PWR | Description |
|-------|--------|---------------|---------|------------------------------------------------------------------------------------------|
| 31:16 | RO | 0000h | Core | Reserved |
| 15:2 | R/W | 0000h | Core | Base Address (BAR) : Base Address of the I/O space (4 consecutive I/O locations). |
| 1 | RO | 0b | Core | Reserved |
| 0 | RO | 1b | Core | Resource Type Indicator (RTE) : This bit indicates a request for I/O space. |

10.5.12 LBAR—Legacy Bus Master Base Address

B/D/F/Type: 0/3/2/PCI
 Address Offset: 20-23h
 Default Value: 00000001h
 Access: RO, R/W
 Size: 32 bits

Reset: Host system Reset or D3->D0 transition

This Bar is used to allocate I/O space for the SFF-8038i mode of operation (aka Bus Master IDE).

| Bit | Access | Default Value | RST/PWR | Description |
|-------|--------|---------------|---------|------------------------------------------------------------------------------------------|
| 31:16 | RO | 0000h | Core | Reserved |
| 15:4 | R/W | 000h | Core | Base Address (BA) : Base Address of the I/O space (16 consecutive I/O locations). |
| 3:1 | RO | 000b | Core | Reserved |
| 0 | RO | 1b | Core | Resource Type Indicator (RTE) : This bit indicates a request for I/O space. |

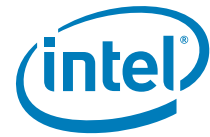

10.5.13 SS—Sub System Identifiers

B/D/F/Type: 0/3/2/PCI
 Address Offset: 2C-2Fh
 Default Value: 00008086h
 Access: R/WO
 Size: 32 bits

Reset: Host System Reset

These registers are used to uniquely identify the add-in card or the subsystem that the device resides within.

| Bit | Access | Default Value | RST/PWR | Description |
|-------|--------|---------------|---------|-----------------------------------------------------------------------------------------------------|
| 31:16 | R/WO | 0000h | Core | Subsystem ID (SSID): This is written by BIOS. No hardware action taken on this value |
| 15:0 | R/WO | 8086h | Core | Subsystem Vendor ID (SSVID): This is written by BIOS. No hardware action taken on this value |

10.5.14 EROM—Expansion ROM Base Address

B/D/F/Type: 0/3/2/PCI
 Address Offset: 30-33h
 Default Value: 00000000h
 Access: RO
 Size: 32 bits

This optional register is not implemented.

| Bit | Access | Default Value | RST/PWR | Description |
|-------|--------|---------------|---------|--------------------------------------------------|
| 31:11 | RO | 000000h | Core | Expansion ROM Base Address (ERBAR): |
| 10:1 | RO | 000h | Core | Reserved |
| 0 | RO | 0b | Core | Enable (EN): Enable expansion ROM Access. |

10.5.15 CAP—Capabilities Pointer

B/D/F/Type: 0/3/2/PCI
 Address Offset: 34h
 Default Value: C8h
 Access: RO
 Size: 8 bits

This optional register is used to point to a linked list of new capabilities implemented by the device.

| Bit | Access | Default Value | RST/PWR | Description |
|-----|--------|---------------|---------|-----------------------------------------------------------------------------------------------------------------------------------------|
| 7:0 | RO | c8h | Core | Capability Pointer (CP): This field indicates that the first capability pointer is offset C8h (the power management capability). |



10.5.16 INTR—Interrupt Information

B/D/F/Type: 0/3/2/PCI
 Address Offset: 3C-3Dh
 Default Value: 0300h
 Access: R/W, RO
 Size: 16 bits

Reset: Host System Reset or D3->D0 reset of the function

See definitions in the registers below

| Bit | Access | Default Value | RST/PWR | Description |
|------|--------|---------------|---------|----------------------------------------------------------------------------------------------------------------------------------------------------------------------------------------------------------------------------------------------------------------|
| 15:8 | RO | 03h | Core | Interrupt Pin (IPIN): A value of 0x1/0x2/0x3/0x4 indicates that this function implements legacy interrupt on INTA/INTB/INTC/INTD, respectively Function Value INTx (2 IDE) 03h INTC |
| 7:0 | R/W | 00h | Core | Interrupt Line (ILINE): The value written in this register indicates which input of the system interrupt controller, the device's interrupt pin is connected to. This value is used by the OS and the device driver, and has no affect on the hardware. |

10.5.17 MGNT—Minimum Grant

B/D/F/Type: 0/3/2/PCI
 Address Offset: 3Eh
 Default Value: 00h
 Access: RO
 Size: 8 bits

This optional register is not implemented.

| Bit | Access | Default Value | RST/PWR | Description |
|-----|--------|---------------|---------|-------------|
| 7:0 | RO | 00h | Core | Reserved |

10.5.18 MLAT—Maximum Latency

B/D/F/Type: 0/3/2/PCI
 Address Offset: 3Fh
 Default Value: 00h
 Access: RO
 Size: 8 bits

This optional register is not implemented.

| Bit | Access | Default Value | RST/PWR | Description |
|-----|--------|---------------|---------|-------------|
| 7:0 | RO | 00h | Core | Reserved |



10.5.19 PID—PCI Power Management Capability ID

B/D/F/Type: 0/3/2/PCI
 Address Offset: C8-C9h
 Default Value: D001h
 Access: RO
 Size: 16 bits

| Bit | Access | Default Value | RST/PWR | Description |
|------|--------|---------------|---------|----------------------------------------------------------------------------------------|
| 15:8 | RO | D0h | Core | Next Capability (NEXT): Its value of D0h points to the MSI capability. |
| 7:0 | RO | 01h | Core | Cap ID (CID): This field indicates that this pointer is a PCI power management. |

10.5.20 PC—PCI Power Management Capabilities

B/D/F/Type: 0/3/2/PCI
 Address Offset: CA-CBh
 Default Value: 0023h
 Access: RO
 Size: 16 bits

This register implements the power management capabilities of the function.

| Bit | Access | Default Value | RST/PWR | Description |
|-------|--------|---------------|---------|-----------------------------------------------------------------------------------------------------------------------|
| 15:11 | RO | 00000b | Core | PME Support (PME): This field indicates no PME# in the PT function |
| 10 | RO | 0b | Core | D2 Support (D2S): The D2 state is not Supported |
| 9 | RO | 0b | Core | D1 Support (D1S): The D1 state is not supported |
| 8:6 | RO | 000b | Core | Aux Current (AUXC): PME# from D3 (cold) state is not supported, therefore this field is 000b |
| 5 | RO | 1b | Core | Device Specific Initialization (DSI): This bit indicates that no device-specific initialization is required. |
| 4 | RO | 0b | Core | Reserved |
| 3 | RO | 0b | Core | PME Clock (PMEC): This bit indicates that PCI clock is not required to generate PME#. |
| 2:0 | RO | 011b | Core | Version (VS): This field indicates support for revision 1.2 of the <i>PCI Power Management Specification</i> . |



10.5.21 PMCS—PCI Power Management Control and Status

B/D/F/Type: 0/3/2/PCI
 Address Offset: CC-CFh
 Default Value: 00000000h
 Access: RO, R/W, RO/V
 Size: 32 bits
 BIOS Optimal Default 0000h

Reset: Host System Reset or D3->D0 transition

This register implements the PCI PM Control and Status Register to allow PM state transitions and Wake up

Note: NSR bit of this register. All registers (PCI configuration and Device Specific) marked with D3->D0 transition reset will only do so if the NSR bit reads a 0. If this bit is a 1, the D3->D0 transition will not reset the registers.

| Bit | Access | Default Value | RST/PWR | Description |
|-------|--------|---------------|---------|------------------------------------------------------------------------------------------------------------------------------------------------------------------------------------------------------------------------------------------------------------------------------------------------------------------------------------------------------------------------------------------------------------------------------------------------------------------------------------------------------------------------------------------------------------------------------------------------------------------------------------------------------------------------------------------------------------------------------------------------------------------------------------------------------------------------------------------------------------------------------------------------------------------------------------------------|
| 31:16 | RO | 0h | | Reserved |
| 15 | RO | 0b | Core | PME Status (PMES): This bit is set when a PME event is to be requested. Not supported |
| 14:9 | RO | 00h | Core | Reserved |
| 8 | RO | 0b | Core | PME Enable (PMEE): Not Supported |
| 7:4 | RO | 0000b | Core | Reserved |
| 3 | RO/V | 0b | Core | No Soft Reset (NSR): When set to 1, this bit indicates that devices transitioning from D3hot to D0 because of PowerState commands do not perform an internal reset. Configuration Context is preserved. Upon transition from the D3hot to the D0 Initialized state, no additional operating system intervention is required to preserve Configuration Context beyond writing the PowerState bits. When cleared to 0, devices do perform an internal reset upon transitioning from D3hot to D0 via software control of the PowerState bits. Configuration Context is lost when performing the soft reset. Upon transition from the D3hot to the D0 state, full re-initialization sequence is needed to return the device to D0 Initialized. Value in this bit is reflects chicken bit in ME-AUX register x13900, bit [7] which is as follows: 0 = Device performs internal reset 1 = Device does not perform internal reset |
| 2 | RO | 0b | Core | Reserved |
| 1:0 | R/W | 00b | Core | Power State (PS): This field is used both to determine the current power state of the PT function and to set a new power state. The values are: 00 = D0 state 11 = D3 _{HOT} state When in the D3 _{HOT} state, the controller's configuration space is available, but the I/O and memory spaces are not. Additionally, interrupts are blocked. If software attempts to write a '10' or '01' to these bits, the write will be ignored. |

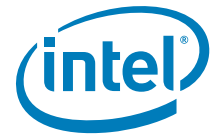

10.5.22 MID—Message Signaled Interrupt Capability ID

B/D/F/Type: 0/3/2/PCI
 Address Offset: D0-D1h
 Default Value: 0005h
 Access: RO
 Size: 16 bits

Message Signalled Interrupt is a feature that allows the device/function to generate an interrupt to the host by performing a DWord memory write to a system specified address with system specified data. This register is used to identify and configure an MSI capable device.

| Bit | Access | Default Value | RST/PWR | Description |
|------|--------|---------------|---------|---------------------------------------------------------------------------------------------------------|
| 15:8 | RO | 00h | Core | Next Pointer (NEXT): This value indicates this is the last item in the capabilities list. |
| 7:0 | RO | 05h | Core | Capability ID (CID): The Capabilities ID value indicates device is capable of generating an MSI. |

10.5.23 MC—Message Signaled Interrupt Message Control

B/D/F/Type: 0/3/2/PCI
 Address Offset: D2-D3h
 Default Value: 0080h
 Access: RO, R/W
 Size: 16 bits

Reset: Host System Reset or D3->D0 transition

This register provides System Software control over MSI.

| Bit | Access | Default Value | RST/PWR | Description |
|------|--------|---------------|---------|--------------------------------------------------------------------------------------------------------------------------------------------|
| 15:8 | RO | 00h | Core | Reserved |
| 7 | RO | 1b | Core | 64 Bit Address Capable (C64): Capable of generating 64-bit and 32-bit messages. |
| 6:4 | R/W | 000b | Core | Multiple Message Enable (MME): These bits are R/W for software compatibility, but only one message is ever sent by the PT function. |
| 3:1 | RO | 000b | Core | Multiple Message Capable (MMC): Only one message is required. |
| 0 | R/W | 0b | Core | MSI Enable (MSIE): If set, MSI is enabled and traditional interrupt pins are not used to generate interrupts. |



10.5.24 MA—Message Signaled Interrupt Message Address

B/D/F/Type: 0/3/2/PCI
 Address Offset: D4-D7h
 Default Value: 00000000h
 Access: R/W, RO
 Size: 32 bits

Reset: Host system Reset or D3->D0 transition

This register specifies the DWORD aligned address programmed by system software for sending MSI.

| Bit | Access | Default Value | RST/PWR | Description |
|------|--------|---------------|---------|----------------------------------------------------------------------------------------------------------------------------|
| 31:2 | R/W | 00000000h | Core | Address (ADDR): This field contains the Lower 32 bits of the system specified message address, always DWord aligned |
| 1:0 | RO | 00b | Core | Reserved |

10.5.25 MAU—Message Signaled Interrupt Message Upper Address

B/D/F/Type: 0/3/2/PCI
 Address Offset: D8-DBh
 Default Value: 00000000h
 Access: RO, R/W
 Size: 32 bits

Reset: Host system Reset or D3->D0 transition

Upper 32 bits of the message address for the 64bit address capable device.

| Bit | Access | Default Value | RST/PWR | Description |
|------|--------|---------------|---------|------------------------------------------------------------------------------------------------------|
| 31:4 | RO | 0000000h | Core | Reserved |
| 3:0 | R/W | 0000b | Core | Address (ADDR): This field contains the Upper 4 bits of the system specified message address. |

10.5.26 MD—Message Signaled Interrupt Message Data

B/D/F/Type: 0/3/2/PCI
 Address Offset: DC-DDh
 Default Value: 0000h
 Access: R/W
 Size: 16 bits

Reset: Host system Reset or D3->D0 transition

This 16-bit field is programmed by system software if MSI is enabled.

| Bit | Access | Default Value | RST/PWR | Description |
|------|--------|---------------|---------|---------------------------------------------------------------------------------------------------------------------|
| 15:0 | R/W | 0000h | Core | Data (DATA): This content is driven onto the lower word of the data bus of the MSI memory write transaction. |



10.6 IDE BAR0

Table 22. IDE BAR0 Register Address Map

| Address Offset | Register Symbol | Register Name | Default Value | Access |
|----------------|-----------------|-----------------------------------------|---------------|--------|
| 0h | IDEDATA | IDE Data Register | 00h | R/W |
| 1h | IDEERD1 | IDE Error Register DEV1 | 00h | R/W/V |
| 1h | IDEERD0 | IDE Error Register DEV0 | 00h | R/W/V |
| 1h | IDEFR | IDE Features Register | 00h | R/W/V |
| 2h | IDESCIR | IDE Sector Count In Register | 00h | R/W/V |
| 2h | IDESCOR1 | IDE Sector Count Out Register Device 1 | 00h | R/W/V |
| 2h | IDESCOR0 | IDE Sector Count Out Register Device 0 | 00h | R/W/V |
| 3h | IDESNOR0 | IDE Sector Number Out Register Device 0 | 00h | R/W/V |
| 3h | IDESNOR1 | IDE Sector Number Out Register Device 1 | 00h | R/W/V |
| 3h | IDESNIR | IDE Sector Number In Register | 00h | R/W/V |
| 4h | IDECLIR | IDE Cylinder Low In Register | 00h | R/W/V |
| 4h | IDCLOR1 | IDE Cylinder Low Out Register Device 1 | 00h | R/W/V |
| 4h | IDCLOR0 | IDE Cylinder Low Out Register Device 0 | 00h | R/W/V |
| 5h | IDCHOR0 | IDE Cylinder High Out Register Device 0 | 00h | R/W/V |
| 5h | IDCHOR1 | IDE Cylinder High Out Register Device 1 | 00h | R/W/V |
| 5h | IDECHIR | IDE Cylinder High In Register | 00h | R/W/V |
| 6h | IDEDHIR | IDE Drive/Head In Register | 00h | R/W/V |
| 6h | IDDHOR1 | IDE Drive Head Out Register Device 1 | 00h | R/W/V |
| 6h | IDDHOR0 | IDE Drive Head Out Register Device 0 | 00h | R/W/V |
| 7h | IDESD0R | IDE Status Device 0 Register | 80h | R/W/V |
| 7h | IDESD1R | IDE Status Device 1 Register | 80h | R/W/V |
| 7h | IDECCR | IDE Command Register | 00h | R/W/V |

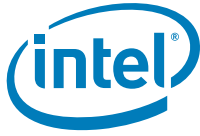

10.6.1 IDEDATA—IDE Data Register

B/D/F/Type: 0/3/2/IDE IO BAR0
 Address Offset: 0h
 Default Value: 00h
 Access: R/W
 Size: 8 bits

The IDE data interface is a special interface that is implemented in the HW. This data interface is mapped to IO space from the host and takes read and write cycles from the host targeting master or slave device.

Writes from host to this register result in the data being written to ME memory.

Reads from host to this register result in the data being fetched from ME memory.

Data is typically written/ read in WORD's. ME-FW must enable hardware to allow it to accept Host initiated Read/ Write cycles, else the cycles are dropped.

| Bit | Access | Default Value | RST/PWR | Description |
|-----|--------|---------------|---------|-------------------------------------------------------------------------------------------------------------------------------------------------------------------------------------------------|
| 7:0 | R/W | 00h | Core | IDE Data Register (IDEDR): Data Register implements the data interface for IDE. All writes and reads to this register translate into one or more corresponding write/ reads to ME memory |

10.6.2 IDEERD1—IDE Error Register Device 1

B/D/F/Type: 0/3/2/IDE IO BAR0
 Address Offset: 1h
 Default Value: 00h
 Access: R/W/V
 Size: 8 bits

Reset: Host system reset or D3->D0 transition

This register implements the Error register of the command block of the IDE function. This register is read only by the HOST interface when DEV = 1 (slave device).

When the HOST writes the same address it writes to the Features register.

| Bit | Access | Default Value | RST/PWR | Description |
|-----|--------|---------------|---------|----------------------------------------------------------------------------------------------------------------------------|
| 7:0 | R/W/V | 00h | Core | IDE Error Data (IDEED): Drive reflects its error/ diagnostic code to the host via this register at different times. |



10.6.3 IDEERD0—IDE Error Register DEV0

B/D/F/Type: 0/3/2/IDE IO BAR0
 Address Offset: 1h
 Default Value: 00h
 Access: R/W/V
 Size: 8 bits

Reset: Host system reset or D3->D0 transition

This register implements the Error register of the command block of the IDE function. This register is read only by the HOST interface when DEV = 0 (master device).

When the HOST writes the same address it writes to the Features register.

| Bit | Access | Default Value | RST/PWR | Description |
|-----|--------|---------------|---------|-----------------------------------------------------------------------------------------------------------------------------|
| 7:0 | R/W/V | 00h | Core | IDE Error Data (IDEED) : Drive reflects its error/ diagnostic code to the host via this register at different times. |

10.6.4 IDEFR—IDE Features Register

B/D/F/Type: 0/3/2/IDE IO BAR0
 Address Offset: 1h
 Default Value: 00h
 Access: R/W/V
 Size: 8 bits

Reset: Host system Reset or D3->D0 transition

This register implements the Feature register of the command block of the IDE function. This register can be written only by the Host.

When the HOST reads the same address, it reads the Error register of Device 0 or Device 1 depending on the device_select bit (bit 4 of the drive/head register).

| Bit | Access | Default Value | RST/PWR | Description |
|-----|--------|---------------|---------|-------------------------------------------------------------------------------|
| 7:0 | R/W/V | 00h | Core | IDE Feature Data (IDEFD) : IDE drive specific data written by the Host |



10.6.5 IDESCIR—IDE Sector Count In Register

B/D/F/Type: 0/3/2/IDE IO BAR0
Address Offset: 2h
Default Value: 00h
Access: R/W/V
Size: 8 bits

Reset: Host system Reset or D3->D0 transition

This register implements the Sector Count register of the command block of the IDE function. This register can be written only by the Host. When host writes to this register, all 3 registers (IDESCIR, IDESCOR0, IDESCOR1) are updated with the written value.

A host read to this register address reads the IDE Sector Count Out Register IDESCOR0 if DEV=0 or IDESCOR1 if DEV=1

| Bit | Access | Default Value | RST/PWR | Description |
|-----|--------|---------------|---------|--------------------------------------------------------------------------------------------------|
| 7:0 | R/W/V | 00h | Core | IDE Sector Count Data (IDESCD) : Host writes the number of sectors to be read or written. |

10.6.6 IDESCOR1—IDE Sector Count Out Register Dev1

B/D/F/Type: 0/3/2/IDE IO BAR0
Address Offset: 2h
Default Value: 00h
Access: R/W/V
Size: 8 bits

Reset: Host system Reset or D3->D0 transition

This register is read by the HOST interface if DEV = 1. ME-Firmware writes to this register at the end of a command of the selected device.

When the host writes to this address, the IDE Sector Count In Register (IDESCIR), this register is updated.

| Bit | Access | Default Value | RST/PWR | Description |
|-----|--------|---------------|---------|------------------------------------------------------------------------------------------------|
| 7:0 | R/W/V | 00h | Core | IDE Sector Count Out Dev1 (ISCOD1) : Sector Count register for Slave Device ie Device 1 |



10.6.7 IDESCORO—IDE Sector Count Out Register Device 0

B/D/F/Type: 0/3/2/IDE IO BAR0
 Address Offset: 2h
 Default Value: 00h
 Access: R/W/V
 Size: 8 bits

Reset: Host system Reset or D3->D0 transition

This register is read by the HOST interface if DEV = 0. ME-Firmware writes to this register at the end of a command of the selected device.

When the host writes to this address, the IDE Sector Count In Register (IDESCIR), this register is updated.

| Bit | Access | Default Value | RST/PWR | Description |
|-----|--------|---------------|---------|--------------------------------------------------------------------------------------------------|
| 7:0 | R/W/V | 00h | Core | IDE Sector Count Out Dev0 (ISCOD0) : Sector Count register for Master Device ie Device 0. |

10.6.8 IDESNORO—IDE Sector Number Out Register Device 0

B/D/F/Type: 0/3/2/IDE IO BAR0
 Address Offset: 3h
 Default Value: 00h
 Access: R/W/V
 Size: 8 bits

Reset: Host system Reset or D3->D0 transition

This register is read by the Host if DEV = 0. ME-Firmware writes to this register at the end of a command of the selected device.

When the host writes to the IDE Sector Number In Register (IDESNIR), this register is updated with that value.

| Bit | Access | Default Value | RST/PWR | Description |
|-----|--------|---------------|---------|----------------------------------------------------------------------------------------------|
| 7:0 | R/W/V | 00h | Core | IDE Sector Number Out DEV 0 (IDESNOO) : Sector Number Out register for Master device. |



10.6.9 IDESNOR1—IDE Sector Number Out Register Device 1

B/D/F/Type: 0/3/2/IDE IO BARO
 Address Offset: 3h
 Default Value: 00h
 Access: R/W/V
 Size: 8 bits

Reset: Host system Reset or D3->D0 transition

This register is read by the Host if DEV = 1. ME-Firmware writes to this register at the end of a command of the selected device.

When the host writes to the IDE Sector Number In Register (IDESNIR), this register is updated with that value.

| Bit | Access | Default Value | RST/PWR | Description |
|-----|--------|---------------|---------|--------------------------------------------------------------------------------------------|
| 7:0 | R/W/V | 00h | Core | IDE Sector Number Out DEV 1 (IDESNO1): Sector Number Out register for Slave device. |

10.6.10 IDESNIR—IDE Sector Number In Register

B/D/F/Type: 0/3/2/IDE IO BARO
 Address Offset: 3h
 Default Value: 00h
 Access: R/W/V
 Size: 8 bits

Reset: Host system Reset or D3->D0 transition

This register implements the Sector Number register of the command block of the IDE function. This register can be written only by the Host. When host writes to this register, all 3 registers (IDESNIR, IDESNOR0, IDESNOR1) are updated with the written value.

Host read to this register address reads the IDE Sector Number Out Register IDESNOR0 if DEV=0 or IDESNOR1 if DEV=1.

| Bit | Access | Default Value | RST/PWR | Description |
|-----|--------|---------------|---------|------------------------------------------------------------------------------------------------------------------|
| 7:0 | R/W/V | 00h | Core | IDE Sector Number Data (IDESND): This register contains the number of the first sector to be transferred. |



10.6.11 IDECLIR—IDE Cylinder Low In Register

B/D/F/Type: 0/3/2/IDE IO BARO
 Address Offset: 4h
 Default Value: 00h
 Access: R/W/V
 Size: 8 bits

Reset: Host system Reset or D3->D0 transition

This register implements the Cylinder Low register of the command block of the IDE function. This register can be written only by the Host. When host writes to this register, all 3 registers (IDECLIR, IDECLOR0, IDECLOR1) are updated with the written value.

Host read to this register address reads the IDE Cylinder Low Out Register IDECLOR0 if DEV=0 or IDECLOR1 if DEV=1.

| Bit | Access | Default Value | RST/PWR | Description |
|-----|--------|---------------|---------|---------------------------------------------------------------------------------------------------------|
| 7:0 | R/W/V | 00h | Core | IDE Cylinder Low Data (IDECLD) : Cylinder Low register of the command block of the IDE function. |

10.6.12 IDCLOR1—IDE Cylinder Low Out Register Device 1

B/D/F/Type: 0/3/2/IDE IO BARO
 Address Offset: 4h
 Default Value: 00h
 Access: R/W/V
 Size: 8 bits

Reset: Host system Reset or D3->D0 transition

This register is read by the Host if DEV = 1. ME-Firmware writes to this register at the end of a command of the selected device. When the host writes to the IDE Cylinder Low In Register (IDECLIR), this register is updated with that value.

| Bit | Access | Default Value | RST/PWR | Description |
|-----|--------|---------------|---------|--------------------------------------------------------------------------------------------|
| 7:0 | R/W/V | 00h | Core | IDE Cylinder Low Out DEV 1. (IDECLO1) : Cylinder Low Out Register for Slave Device. |



10.6.13 IDCLOR0—IDE Cylinder Low Out Register Device 0

B/D/F/Type: 0/3/2/IDE IO BAR0
Address Offset: 4h
Default Value: 00h
Access: R/W/V
Size: 8 bits

Reset: Host system Reset or D3->D0 transition

This register is read by the Host if DEV = 0. ME-Firmware writes to this register at the end of a command of the selected device. When the host writes to the IDE Cylinder Low In Register (IDECLIR), this register is updated with that value.

| Bit | Access | Default Value | RST/PWR | Description |
|-----|--------|---------------|---------|--------------------------------------------------------------------------------------------|
| 7:0 | R/W/V | 00h | Core | IDE Cylinder Low Out DEV 0 (IDECLOO) : Cylinder Low Out Register for Master Device. |

10.6.14 IDCHOR0—IDE Cylinder High Out Register Device 0

B/D/F/Type: 0/3/2/IDE IO BAR0
Address Offset: 5h
Default Value: 00h
Access: R/W/V
Size: 8 bits

Reset: Host system Reset or D3->D0 transition

This register is read by the Host if DEVIce = 0. ME-Firmware writes to this register at the end of a command of the selected device. When the host writes to the IDE Cylinder High In Register (IDECHIR), this register is updated with that value.

| Bit | Access | Default Value | RST/PWR | Description |
|-----|--------|---------------|---------|----------------------------------------------------------------------------------------------|
| 7:0 | R/W/V | 00h | Core | IDE Cylinder High Out DEV 0 (IDECHOO) : Cylinder High out register for Master device. |



10.6.15 IDCHOR1—IDE Cylinder High Out Register Device 1

B/D/F/Type: 0/3/2/IDE IO BAR0
 Address Offset: 5h
 Default Value: 00h
 Access: R/W/V
 Size: 8 bits

Reset: Host system Reset or D3->D0 transition

This register is read by the Host if Device = 1. ME-Firmware writes to this register at the end of a command of the selected device. When the host writes to the IDE Cylinder High In Register (IDECHIR), this register is updated with that value.

| Bit | Access | Default Value | RST/PWR | Description |
|-----|--------|---------------|---------|---------------------------------------------------------------------------------------------|
| 7:0 | R/W/V | 00h | Core | IDE Cylinder High Out DEV 1 (IDECHO1) : Cylinder High out register for Slave device. |

10.6.16 IDECHIR—IDE Cylinder High In Register

B/D/F/Type: 0/3/2/IDE IO BAR0
 Address Offset: 5h
 Default Value: 00h
 Access: R/W/V
 Size: 8 bits

Reset: Host system Reset or D3->D0 transition

This register implements the Cylinder High register of the command block of the IDE function. This register can be written only by the Host. When host writes to this register, all 3 registers (IDECHIR, IDECHOR0, IDECHOR1) are updated with the written value.

Host read to this register address reads the IDE Cylinder High Out Register IDECHOR0 if DEV=0 or IDECHOR1 if DEV=1.

| Bit | Access | Default Value | RST/PWR | Description |
|-----|--------|---------------|---------|---------------------------------------------------------------------------------------------|
| 7:0 | R/W/V | 00h | Core | IDE Cylinder High Data (IDECHD) : Cylinder High data register for IDE command block. |



10.6.17 IDEHIR—IDE Drive/Head In Register

B/D/F/Type: 0/3/2/IDE IO BAR0
Address Offset: 6h
Default Value: 00h
Access: R/W/V
Size: 8 bits

Reset: Host system Reset or D3->D0 transition

This register implements the Drive/Head register of the command block of the IDE. This register can be written only by the Host. When host writes to this register, all 3 registers (IDEDHIR, IDEHOR0, IDEHOR1) are updated with the written value.

Host read to this register address reads the IDE Drive/Head Out Register (IDEDHOR0) if DEV=0 or IDEHOR1 if DEV=1.

Bit 4 of this register is the DEV (master/slave) bit. This bit is cleared by hardware on IDE software reset (S_RST toggles to '1') in addition to Host system reset and D3->D0 transition of the function.

| Bit | Access | Default Value | RST/PWR | Description |
|-----|--------|---------------|---------|-----------------------------------------------------------------------------------------------------------|
| 7:0 | R/W/V | 00h | Core | IDE Drive/Head Data (IDEDHD) : Register defines the drive number, head number and addressing mode. |

10.6.18 IDHOR1—IDE Drive Head Out Register Device 1

B/D/F/Type: 0/3/2/IDE IO BAR0
Address Offset: 6h
Default Value: 00h
Access: R/W/V
Size: 8 bits

Reset: Host system Reset or D3->D0 transition

This register is read only by the Host. Host read to this Drive/head In register address reads the IDE Drive/Head Out Register (IDEDHOR0) if DEV=1

Bit 4 of this register is the DEV (master/slave) bit. This bit is cleared by hardware on IDE software reset (S_RST toggles to '1') in addition to the Host system reset and D3 to D0 transition of the IDE function.

When the host writes to this address, it updates the value of the IDEHIR register.

| Bit | Access | Default Value | RST/PWR | Description |
|-----|--------|---------------|---------|--------------------------------------------------------------------------------------|
| 7:0 | R/W/V | 00h | Core | IDE Drive Head Out DEV 1 (IDEDHO1) : Drive/Head Out register of Slave device. |



10.6.19 IDDHOR0—IDE Drive Head Out Register Device 0

B/D/F/Type: 0/3/2/IDE IO BAR0
 Address Offset: 6h
 Default Value: 00h
 Access: R/W/V
 Size: 8 bits

Reset: Host system Reset or D3->D0 transition

This register is read only by the Host. Host read to this Drive/head In register address reads the IDE Drive/Head Out Register (IDEDHOR0) if DEV=0.

Bit 4 of this register is the DEV (master/slave) bit. This bit is cleared by hardware on IDE software reset (S_RST toggles to 1) in addition to the Host system reset and D3 to D0 transition of the IDE function.

When the host writes to this address, it updates the value of the IDEDHIR register.

| Bit | Access | Default Value | RST/PWR | Description |
|-----|--------|---------------|---------|---------------------------------------------------------------------------------------|
| 7:0 | R/W/V | 00h | Core | IDE Drive Head Out DEV 0 (IDEDH00) : Drive/Head Out register of Master device. |



10.6.20 IDESD0R—IDE Status Device 0 Register

B/D/F/Type: 0/3/2/IDE IO BAR0
Address Offset: 7h
Default Value: 80h
Access: R/W/V
Size: 8 bits

Reset: Host system reset or D3->D0 transition

This register implements the status register of the Master device (DEV = 0). This register is read only by the Host. Host read of this register clears the Master device's interrupt.

When the HOST writes to the same address it writes to the command register

The bits description is for ATA mode.

| Bit | Access | Default Value | RST/PWR | Description |
|-----|--------|---------------|---------|-------------------------------------------------------------------------------------------------------------------------------------------------------------------------------------------------------------------------------------|
| 7 | R/W/V | 1b | Core | Busy (BSY) : This bit is set by HW when the IDECR is being written and DEV=0, or when SRST bit is asserted by Host or host system reset or D3-to-D0 transition of the IDE function. This bit is cleared by FW write of 0. |
| 6 | R/W/V | 0b | Core | Drive Ready (DRDY) : When set, this bit indicates drive is ready for command. |
| 5 | R/W/V | 0b | Core | Drive Fault (DF) : Indicates Error on the drive. |
| 4 | R/W/V | 0b | Core | Drive Seek Complete (DSC) : Indicates Heads are positioned over the desired cylinder. |
| 3 | R/W/V | 0b | Core | Data Request (DRQ) : Set when, the drive wants to exchange data with the Host via the data register. |
| 2 | R/W/V | 0b | Core | Corrected Data (CORR) : When set, this bit indicates a correctable read error has occurred. |
| 1 | R/W/V | 0b | Core | Index (IDX) : This bit is set once per rotation of the medium when the index mark passes under the read/write head. |
| 0 | R/W/V | 0b | Core | Error (ERR) : When set, this bit indicates an error occurred in the process of executing the previous command. The Error Register of the selected device contains the error information. |



10.6.21 IDESD1R—IDE Status Device 1 Register

B/D/F/Type: 0/3/2/IDE IO BAR0
 Address Offset: 7h
 Default Value: 80h
 Access: R/W/V
 Size: 8 bits

Reset: Host system reset or D3->D0 transition

This register implements the status register of the slave device (DEV = 1). This register is read only by the Host. Host read of this register clears the slave device's interrupt.

When the HOST writes to the same address it writes to the command register.

The bits description is for ATA mode.

| Bit | Access | Default Value | RST/PWR | Description |
|-----|--------|---------------|---------|-----------------------------------------------------------------------------------------------------------------------------------------------------------------------------------------------------------------------------------------------|
| 7 | R/W/V | 1b | Core | Busy (BSY) : This bit is set by hardware when the IDECR is being written and DEV=0, or when SRST bit is asserted by the Host or host system reset or D3-to-D0 transition of the IDE function. This bit is cleared by FW write of 0. |
| 6 | R/W/V | 0b | Core | Drive Ready (DRDY) : When set, indicates drive is ready for command. |
| 5 | R/W/V | 0b | Core | Drive Fault (DF) : Indicates Error on the drive. |
| 4 | R/W/V | 0b | Core | Drive Seek Complete (DSC) : Indicates Heads are positioned over the desired cylinder. |
| 3 | R/W/V | 0b | Core | Data Request (DRQ) : Set when the drive wants to exchange data with the Host via the data register. |
| 2 | R/W/V | 0b | Core | Corrected Data (CORR) : When set indicates a correctable read error has occurred. |
| 1 | R/W/V | 0b | Core | Index (IDX) : This bit is set once per rotation of the medium when the index mark passes under the read/write head. |
| 0 | R/W/V | 0b | Core | Error (ERR) : When set, this bit indicates an error occurred in the process of executing the previous command. The Error Register of the selected device contains the error information |



10.6.22 IDECR—IDE Command Register

B/D/F/Type: 0/3/2/IDE IO BAR0
Address Offset: 7h
Default Value: 00h
Access: R/W/V
Size: 8 bits

Reset: Host system Reset and D3->D0 transition

This register implements the Command register of the command block of the IDE function. This register can be written only by the Host.

When the HOST reads the same address it reads the Status register DEV0 if DEV=0 or Status Register DEV1 if DEV=1 (Drive/Head register bit [4]).

| Bit | Access | Default Value | RST/PWR | Description |
|-----|--------|---------------|---------|--------------------------------------------------------------------------------------------------------------|
| 7:0 | R/W/V | 00h | Core | IDE Command Data (IDECD): Host sends the commands (read/ write, etc.) to the drive via this register. |



10.7 IDE BAR1

| Address Offset | Register Symbol | Register Name | Default Value | Access |
|----------------|-----------------|-------------------------------|---------------|--------|
| 2h | IDDCR | IDE Device Control Register | 00h | RO, WO |
| 2h | IDASR | IDE Alternate status Register | 00h | RO/V |

10.7.1 IDDCR—IDE Device Control Register

B/D/F/Type: 0/3/2/IDE IO BAR1
 Address Offset: 2h
 Default Value: 00h
 Access: RO, WO
 Size: 8 bits

Reset: Host system Reset or D3->D0 transition

This register implements the Device Control register of the Control block of the IDE function. This register is Write only by the Host.

When the HOST reads to the same address it reads the Alternate Status register.

| Bit | Access | Default Value | RST/PWR | Description |
|-----|--------|---------------|---------|-----------------------------------------------------------------------------------------------------------------|
| 7:3 | RO | 00000b | Core | Reserved: Writable by Host, but no hardware affect due to writes. |
| 2 | WO | 0b | Core | Software reset (S_RST) : When this bit is set by the Host, it forces a reset to the device. |
| 1 | WO | 0b | Core | Host interrupt Disable (nIEN) : When set, this bit disables hardware from sending interrupt to the Host. |
| 0 | RO | 0b | Core | Reserved: Writable by Host, but no hardware affect due to writes |



10.7.2 IDASR—IDE Alternate status Register

B/D/F/Type: 0/3/2/IDE IO BAR1
Address Offset: 2h
Default Value: 00h
Access: RO/V
Size: 8 bits

Reset: This is not a physical register hence no reset associated with it.

This register implements the Alternate Status register of the Control block of the IDE function. This register is a mirror register to the status register in the command block. Reading this register by the HOST does not clear the IDE interrupt of the DEV selected device

Host read of this register when DEV=0 (Master), Host gets the mirrored data of IDESD0R register.

Host read of this register when DEV=1 (Slave), host gets the mirrored data of IDESD1R register.

| Bit | Access | Default Value | RST/PWR | Description |
|-----|--------|---------------|---------|---------------------------------------------------------------------------------------------------------------------------------------------------------------------|
| 7:0 | RO/V | 00h | Core | IDE Alternate Status Register (IDEASR): This field mirrors the value of the DEV0/ DEV1 status register, depending on the state of the DEV bit on Host reads. |



10.8 IDE BAR4

Table 23. IDE BAR4 Register Address Map

| Address Offset | Register Symbol | Register Name | Default Value | Access |
|----------------|-----------------|-------------------------------------------------------------------|---------------|---------------|
| 0h | IDEPBMCRCR | IDE Primary Bus Master Command Register | 00h | RO, R/W |
| 1h | IDEPBMDSR0R | IDE Primary Bus Master Device Specific 0 Register | 00h | R/W |
| 2h | IDEPBMSR | IDE Primary Bus Master Status Register | 80h | RO, R/W, R/WC |
| 3h | IDEPBMDSR1R | IDE Primary Bus Master Device Specific 1 Register | 00h | R/W |
| 4h | IDEPBMDTPR0 | IDE Primary Bus Master Descriptor Table Pointer Register Byte 0 | 00h | R/W |
| 5h | IDEPBMDTPR1 | IDE Primary Bus Master Descriptor Table Pointer Register Byte 1 | 00h | R/W |
| 6h | IDEPBMDTPR2 | IDE Primary Bus Master Descriptor Table Pointer Register Byte 2 | 00h | R/W |
| 7h | IDEPBMDTPR3 | IDE Primary Bus Master Descriptor Table Pointer Register Byte 3 | 00h | R/W |
| 8h | IDESBMCR | IDE Secondary Bus Master Command Register | 00h | RO, R/W |
| 9h | IDESBMSR0R | IDE Secondary Bus Master Device Specific 0 Register | 00h | R/W |
| Ah | IDESBMSR | IDE Secondary Bus Master Status Register | 00h | R/W, RO |
| Bh | IDESBMSR1R | IDE Secondary Bus Master Device Specific 1 Register | 00h | R/W |
| Ch | IDESBMDTPR0 | IDE Secondary Bus Master Descriptor Table Pointer Register Byte 0 | 00h | R/W |
| Dh | IDESBMDTPR1 | IDE Secondary Bus Master Descriptor Table Pointer Register Byte 1 | 00h | R/W |
| Eh | IDESBMDTPR2 | IDE Secondary Bus Master Descriptor Table Pointer Register Byte 2 | 00h | R/W |
| Fh | IDESBMDTPR3 | IDE Secondary Bus Master Descriptor Table Pointer Register Byte 3 | 00h | R/W |



10.8.1 IDEPBMCR—IDE Primary Bus Master Command Register

B/D/F/Type: 0/3/2/IDE IO BAR4
Address Offset: 0h
Default Value: 00h
Access: RO, R/W
Size: 8 bits

Reset: See specific bits.

This register implements the bus master command register of the primary channel. This register is programmed by the Host.

| Bit | Access | Default Value | RST/PWR | Description |
|-----|--------|---------------|---------|--------------------------------------------------------------------------------------------------------------------------------------------------------------------------------------------------------------------------------------------------------------------------------------------------------------------------------------------------------------------------------------------------------------------------------------------------------------------------------|
| 7:4 | RO | 0h | Core | Reserved |
| 3 | R/W | 0b | Core | Read Write Command (RWC): This bit sets the direction of bus master transfer. 0 = Reads are performed from system memory 1 = Writes are performed to System Memory. This bit should not be changed when the bus master function is active. Reset: Host system Reset or D3->D0 transition |
| 2:1 | RO | 00b | Core | Reserved |
| 0 | R/W | 0b | Core | Start/Stop Bus Master (SSBM): This bit gates the bus master operation of IDE function when 0. Writing 1 enables the bus master operation. Bus master operation can be halted by writing a 0 to this bit. Operation cannot be stopped and resumed. This bit is cleared after data transfer is complete as indicated by either the BMIA bit or the INT bit of the Bus Master status register is set or both are set. Reset: Host system Reset or D3->D0 transition. |

10.8.2 IDEPBMSD0R—IDE Primary Bus Master Device Specific 0 Register

B/D/F/Type: 0/3/2/IDE IO BAR4
Address Offset: 1h
Default Value: 00h
Access: R/W
Size: 8 bits

Reset: ME System Reset

This register implements the bus master Device Specific 1 register of the primary channel. This register is programmed by the Host.

| Bit | Access | Default Value | RST/PWR | Description |
|-----|--------|---------------|---------|------------------------------------------------------|
| 7:0 | R/W | 00h | Core | Device Specific Data0 (DSD0): Device Specific |



10.8.3 IDEPBMSR—IDE Primary Bus Master Status Register

B/D/F/Type: 0/3/2/IDE IO BAR4
 Address Offset: 2h
 Default Value: 80h
 Access: RO, R/W, R/WC
 Size: 8 bits

Reset: See bit definitions.

This register implements the Bus Master Status register of the primary channel.

| Bit | Access | Default Value | RST/PWR | Description |
|-----|--------|---------------|---------|-------------------------------------------------------------------------------------------------------------------------------------------------------------------------------------------------------------------------------------------------------------------------------------|
| 7 | RO | 1b | Core | Simplex Only (SO) : Value indicates whether both Bus Master Channels can be operated at the same time or not. 0 = Both can be operated independently 1 = Only one can be operated at a time. Reset: ME System Reset |
| 6 | R/W | 0b | Core | Drive 1 DMA Capable (D1DC) : This bit is read/write by the host (not write 1 clear). Reset: Host system Reset or D3->D0 transition of the function |
| 5 | R/W | 0b | Core | Drive 0 DMA Capable (D0DC) : This bit is read/write by the host (not write 1 clear). Reset: Host system Reset or D3->D0 transition of the function |
| 4:3 | RO | 00b | Core | Reserved |
| 2 | R/WC | 0b | Core | Interrupt (INT) : This bit is set by the hardware when it detects a positive transition in the interrupt logic (refer to IDE host interrupt generation diagram). The hardware will clear this bit when the Host SW writes 1 to it. Reset: ME System Reset |
| 1 | R/WC | 0b | Core | Error (ER) : Bit is typically set by FW. Hardware will clear this bit when the Host SW writes 1 to it. Reset: ME System Reset |
| 0 | RO | 0b | Core | Bus Master IDE Active (BMIA) : This bit is set by hardware when SSBM register is set to 1 by the Host. When the bus master operation ends (for the whole command) this bit is cleared by FW. This bit is not cleared when the HOST writes 1 to it. Reset: ME system Reset |

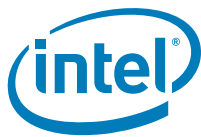

10.8.4 IDEPBMD51R—IDE Primary Bus Master Device Specific 1 Register

B/D/F/Type: 0/3/2/IDE IO BAR4
 Address Offset: 3h
 Default Value: 00h
 Access: R/W
 Size: 8 bits

Reset: ME system Reset

This register implements the bus master Device Specific 1 register of the primary channel. This register is programmed by the Host for device specific data if any.

| Bit | Access | Default Value | RST/PWR | Description |
|-----|--------|---------------|---------|------------------------------------------------------------|
| 7:0 | R/W | 00h | Core | Device Specific Data1 (DSD1): Device Specific Data. |

10.8.5 IDEPBMDTPRO—IDE Primary Bus Master Descriptor Table Pointer Register Byte 0

B/D/F/Type: 0/3/2/IDE IO BAR4
 Address Offset: 4h
 Default Value: 00h
 Access: R/W
 Size: 8 bits

Reset: Host system Reset or D3->D0 transition

This register implements the Byte 0 (1 of 4 bytes) of the descriptor table Pointer (four I/O byte addresses) for bus master operation of the primary channel. This register is read/write by the HOST interface.

| Bit | Access | Default Value | RST/PWR | Description |
|-----|--------|---------------|---------|-------------------------------------------------|
| 7:0 | R/W | 00h | Core | Descriptor Table Pointer Byte 0 (DTPB0): |

10.8.6 IDEPBMDTPR1—IDE Primary Bus Master Descriptor Table Pointer Register Byte 1

B/D/F/Type: 0/3/2/IDE IO BAR4
 Address Offset: 5h
 Default Value: 00h
 Access: R/W
 Size: 8 bits

Reset: Host system Reset or D3->D0 transition

This register implements the Byte 1 (of four bytes) of the descriptor table Pointer (four I/O byte addresses) for bus master operation of the primary channel. This register is programmed by the Host.

| Bit | Access | Default Value | RST/PWR | Description |
|-----|--------|---------------|---------|-------------------------------------------------|
| 7:0 | R/W | 00h | Core | Descriptor Table Pointer Byte 1 (DTPB1): |

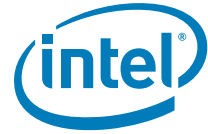

10.8.7 IDEPBMDTPR2—IDE Primary Bus Master Descriptor Table Pointer Register Byte 2

B/D/F/Type: 0/3/2/IDE IO BAR4
 Address Offset: 6h
 Default Value: 00h
 Access: R/W
 Size: 8 bits

Reset: Host system Reset or D3->D0 transition

This register implements the Byte 2 (of four bytes) of the descriptor table Pointer (four I/O byte addresses) for bus master operation of the primary channel. This register is programmed by the Host.

| Bit | Access | Default Value | RST/PWR | Description |
|-----|--------|---------------|---------|------------------------------------------|
| 7:0 | R/W | 00h | Core | Descriptor Table Pointer Byte 2 (DTPB2): |

10.8.8 IDEPBMDTPR3—IDE Primary Bus Master Descriptor Table Pointer Register Byte 3

B/D/F/Type: 0/3/2/IDE IO BAR4
 Address Offset: 7h
 Default Value: 00h
 Access: R/W
 Size: 8 bits

Reset: Host system Reset or D3->D0 transition

This register implements the Byte 3 (of four bytes) of the descriptor table Pointer (four I/O byte addresses) for bus master operation of the primary channel. This register is programmed by the Host.

| Bit | Access | Default Value | RST/PWR | Description |
|-----|--------|---------------|---------|------------------------------------------|
| 7:0 | R/W | 00h | Core | Descriptor Table Pointer Byte 3 (DTPB3): |



10.8.9 IDESBMCR—IDE Secondary Bus Master Command Register

B/D/F/Type: 0/3/2/IDE IO BAR4
 Address Offset: 8h
 Default Value: 00h
 Access: RO, R/W
 Size: 8 bits

Reset: See specific bits

This register implements the bus master command register of the secondary channel. This register is programmed by the Host.

| Bit | Access | Default Value | RST/PWR | Description |
|-----|--------|---------------|---------|-------------------------------------------------------------------------------------------------------------------------------------------------------------------------------------------------------------------------------------------------------------------------------------------------------------------------------------------------------------------------------------------------------------------------------------------------------------------------------------------|
| 7:4 | RO | 0h | Core | Reserved |
| 3 | R/W | 0b | Core | Read Write Command (RWC): This bit sets the direction of bus master transfer. When 0, Reads are performed from system memory; when 1, writes are performed to System Memory. This bit should not be changed when the bus master function is active. Reset: Host system Reset or D3->D0 transition of function |
| 2:1 | RO | 00b | Core | Reserved |
| 0 | R/W | 0b | Core | Start/Stop Bus Master (SSBM): This bit gates the bus master operation of IDE function when zero. Writing 1 enables the bus master operation. Bus master operation can be halted by writing a 0 to this bit. Operation cannot be stopped and resumed. This bit is cleared after data transfer is complete as indicated by either the BMIA bit or the INT bit of the Bus Master status register is set or both are set. Reset: Host system Reset or D3->D0 transition of function |

10.8.10 IDESBMDSOR—IDE Secondary Bus Master Device Specific 0 Register

B/D/F/Type: 0/3/2/IDE IO BAR4
 Address Offset: 9h
 Default Value: 00h
 Access: R/W
 Size: 8 bits

Reset: ME System Reset

This register implements the bus master Device Specific 1 register of the secondary channel. This register is programmed by the Host.

| Bit | Access | Default Value | RST/PWR | Description |
|-----|--------|---------------|---------|------------------------------------------------------|
| 7:0 | R/W | 00h | Core | Device Specific Data0 (DSD0): Device Specific |



10.8.11 IDESBMSR—IDE Secondary Bus Master Status Register

B/D/F/Type: 0/3/2/IDE IO BAR4
 Address Offset: Ah
 Default Value: 00h
 Access: R/W, RO
 Size: 8 bits

Reset: See bit definitions

This register implements the Bus Master Status register of the secondary channel.

| Bit | Access | Default Value | RST/PWR | Description |
|-----|--------|---------------|---------|----------------------------------------------------------------------------------------------------------------------------------------------------------------------------------------------------------------------------------------------------------------|
| 7 | R/W | 0b | Core | Simplex Only (SO) : This bit indicates whether both Bus Master Channels can be operated at the same time or not. 0 = Both can be operated independently 1 = Only one can be operated at a time. Reset: Host system reset or D3->D0 transition. |
| 6 | R/W | 0b | Core | Drive 1 DMA Capable (D1DC) : This bit is read/write by the host. Reset: Host system Reset or D3->D0 transition of the function. |
| 5 | R/W | 0b | Core | Drive 0 DMA Capable (D0DC) : This bit is read/write by the host. Reset: Host system Reset or D3->D0 transition of the function. |
| 4:3 | RO | 00b | Core | Reserved |
| 2 | R/W | 0b | Core | Interrupt (INT) : No functionality implemented. Read/Write by Host. Reset: Host System Reset or D3->D0 transition. |
| 1 | RO | 0b | Core | Error (ER) : Not implemented. |
| 0 | RO | 0b | Core | Bus Master IDE Active (BMIA) : Not implemented. |

10.8.12 IDESBMDS1R—IDE Secondary Bus Master Device Specific 1 Register

B/D/F/Type: 0/3/2/IDE IO BAR4
 Address Offset: Bh
 Default Value: 00h
 Access: R/W
 Size: 8 bits

Reset: ME system Reset.

This register implements the bus master Device Specific 1 register of the secondary channel. This register is programmed by the Host for device specific data if any.

| Bit | Access | Default Value | RST/PWR | Description |
|-----|--------|---------------|---------|-------------------------------------------------------------|
| 7:0 | R/W | 00h | Core | Device Specific Data1 (DSD1) : Device Specific Data. |



10.8.13 IDESBMDTPR0—IDE Secondary Bus Master Descriptor Table Pointer Register Byte 0

B/D/F/Type: 0/3/2/IDE IO BAR4
Address Offset: Ch
Default Value: 00h
Access: R/W
Size: 8 bits

Reset: Host system Reset or D3->D0 transition of the function.

This register implements the Byte 0 (1 of 4 bytes) of the descriptor table Pointer (four I/O byte addresses) for bus master operation of the secondary channel. This register is read/write by the HOST interface.

| Bit | Access | Default Value | RST/PWR | Description |
|-----|--------|---------------|---------|-------------------------------------------------|
| 7:0 | R/W | 00h | Core | Descriptor Table Pointer Byte 0 (DTPB0): |

10.8.14 IDESBMDTPR1—IDE Secondary Bus Master Descriptor Table Pointer Register Byte 1

B/D/F/Type: 0/3/2/IDE IO BAR4
Address Offset: Dh
Default Value: 00h
Access: R/W
Size: 8 bits

Reset: Host system Reset or D3->D0 transition of the function.

This register implements the Byte 1 (of four bytes) of the descriptor table Pointer (four I/O byte addresses) for bus master operation of the secondary channel. This register is programmed by the Host.

| Bit | Access | Default Value | RST/PWR | Description |
|-----|--------|---------------|---------|-------------------------------------------------|
| 7:0 | R/W | 00h | Core | Descriptor Table Pointer Byte 1 (DTPB1): |

10.8.15 IDESBMDTPR2—IDE Secondary Bus Master Descriptor Table Pointer Register Byte 2

B/D/F/Type: 0/3/2/IDE IO BAR4
Address Offset: Eh
Default Value: 00h
Access: R/W
Size: 8 bits

Reset: Host system Reset or D3->D0 transition of the function.

This register implements the Byte 2 (of four bytes) of the descriptor table Pointer (four I/O byte addresses) for bus master operation of the secondary channel. This register is programmed by the Host.

| Bit | Access | Default Value | RST/PWR | Description |
|-----|--------|---------------|---------|-------------------------------------------------|
| 7:0 | R/W | 00h | Core | Descriptor Table Pointer Byte 2 (DTPB2): |

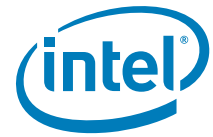

10.8.16 IDESBMDTPR3—IDE Secondary Bus Master Descriptor Table Pointer Register Byte 3

B/D/F/Type: 0/3/2/IDE IO BAR4
 Address Offset: Fh
 Default Value: 00h
 Access: R/W
 Size: 8 bits

Reset: Host system Reset or D3->D0 transition of the function.

This register implements the Byte 3 (of four bytes) of the descriptor table Pointer (four I/O byte addresses) for bus master operation of the secondary channel. This register is programmed by the Host.

| Bit | Access | Default Value | RST/PWR | Description |
|-----|--------|---------------|---------|-------------------------------------------------|
| 7:0 | R/W | 00h | Core | Descriptor Table Pointer Byte 3 (DTPB3): |



10.9 Serial Port for Remote Keyboard and Text (KT) Redirection

Table 24. Serial Port for Remote Keyboard and Text (KT) Redirection Register Address Map

| Address Offset | Register Symbol | Register Name | Default Value | Access |
|----------------|-----------------|--------------------------------------------------|--------------------------|---------------|
| 0–3h | ID | Identification | 2E078086h | RO |
| 4–5h | CMD | Command Register | 0000h | RO, R/W |
| 6–7h | STS | Device Status | 00B0h | RO |
| 8h | RID | Revision ID | see register description | RO |
| 9–Bh | CC | Class Codes | 070002h | RO |
| Ch | CLS | Cache Line Size | 00h | RO |
| Dh | MLT | Master Latency Timer | 00h | RO |
| Eh | HTYPE | Header Type | Not Defined | Not Defined |
| Fh | BIST | Built In Self Test | Not Defined | Not Defined |
| 10–13h | KTIBA | KT IO Block Base Address | 00000001h | RO, R/W |
| 14–17h | KTMBBA | KT Memory Block Base Address | 00000000h | RO, R/W |
| 2C–2Fh | SS | Sub System Identifiers | 00008086h | R/WO |
| 30–33h | EROM | Expansion ROM Base Address | 00000000h | RO |
| 34h | CAP | Capabilities Pointer | C8h | RO |
| 3C–3Dh | INTR | Interrupt Information | 0200h | R/W, RO |
| 3Eh | MGNT | Minimum Grant | 00h | RO |
| 3Fh | MLAT | Maximum Latency | 00h | RO |
| C8–C9h | PID | PCI Power Management Capability ID | D001h | RO |
| CA–CBh | PC | PCI Power Management Capabilities | 0023h | RO |
| CC–CFh | PMCS | PCI Power Management Control and Status | 00000000h | RO/V, RO, R/W |
| D0–D1h | MID | Message Signaled Interrupt Capability ID | 0005h | RO |
| D2–D3h | MC | Message Signaled Interrupt Message Control | 0080h | RO, R/W |
| D4–D7h | MA | Message Signaled Interrupt Message Address | 00000000h | RO, R/W |
| D8–DBh | MAU | Message Signaled Interrupt Message Upper Address | 00000000h | RO, R/W |
| DC–DDh | MD | Message Signaled Interrupt Message Data | 0000h | R/W |



10.9.1 ID—Identification

B/D/F/Type: 0/3/3/PCI
 Address Offset: 0-3h
 Default Value: 2E078086h
 Access: RO
 Size: 32 bits

This register, combined with the Device Identification register, uniquely identifies any PCI device.

| Bit | Access | Default Value | RST/PWR | Description |
|-------|--------|---------------|---------|----------------------------------------------------------------------------------------------------|
| 31:16 | RO | 2E07h | Core | Device ID (DID): Assigned by manufacturer, identifies the device. |
| 15:0 | RO | 8086h | Core | Vendor ID (VID): 16-bit field which indicates Intel is the vendor, assigned by the PCI SIG. |

10.9.2 CMD—Command Register

B/D/F/Type: 0/3/3/PCI
 Address Offset: 4-5h
 Default Value: 0000h
 Access: RO, R/W
 Size: 16 bits

Reset: Host System reset or D3->D0 transition

This register provides basic control over the device's ability to respond to and perform Host system related accesses.

| Bit | Access | Default Value | RST/PWR | Description |
|-------|--------|---------------|---------|----------------------------------------------------------------------------------------------------------------------------------------------------------------------------------------------------------------------------------------------------------------------------------|
| 15:11 | RO | 00h | Core | Reserved |
| 10 | R/W | 0b | Core | Interrupt Disable (ID): This bit disables pin-based INTx# interrupts. This bit has no effect on MSI operation. 1 = Internal INTx# messages will not be generated. 0 = Internal INTx# messages are generated if there is an interrupt and MSI is not enabled. |
| 9 | RO | 0b | Core | Fast back-to-back enable (FBE): Reserved |
| 8 | RO | 0b | Core | SERR# Enable (SEE): The PT function never generates an SERR#. Reserved |
| 7 | RO | 0b | Core | Wait Cycle Enable (WCC): Reserved |
| 6 | RO | 0b | Core | Parity Error Response Enable (PEE): No Parity detection in PT functions. Reserved |
| 5 | RO | 0b | Core | VGA Palette Snooping Enable (VGA): Reserved |
| 4 | RO | 0b | Core | Memory Write and Invalidate Enable (MWIE): Reserved |
| 3 | RO | 0b | Core | Special Cycle enable (SCE): Reserved |



| Bit | Access | Default Value | RST/PWR | Description |
|-----|--------|---------------|---------|----------------------------------------------------------------------------------------------------------------------------------------------------------------------------------------------------------------------------------------------------------------------|
| 2 | R/W | 0b | Core | Bus Master Enable (BME): This bit controls the KT function's ability to act as a master for data transfers. This bit does not impact the generation of completions for split transaction commands. For KT, the only bus mastering activity is MSI generation. |
| 1 | R/W | 0b | Core | Memory Space Enable (MSE): This bit controls Access to the PT function's target memory space. |
| 0 | R/W | 0b | Core | I/O Space enable (IOSE): This bit controls access to the PT function's target I/O space. |

10.9.3 STS—Device Status

B/D/F/Type: 0/3/3/PCI
 Address Offset: 6-7h
 Default Value: 00B0h
 Access: RO
 Size: 16 bits

This register is used by the function to reflect its PCI status to the host for the functionality that it implements

| Bit | Access | Default Value | RST/PWR | Description |
|------|--------|---------------|---------|--------------------------------------------------------------------------------------------------------------------------------------------------------------------------------------------------------------------------------------------------------|
| 15 | RO | 0b | Core | Detected Parity Error (DPE): No parity error on its interface. |
| 14 | RO | 0b | Core | Signaled System Error (SSE): The PT function will never generate an SERR#. |
| 13 | RO | 0b | Core | Received Master-Abort Status (RMA): Reserved |
| 12 | RO | 0b | Core | Received Target-Abort Status (RTA): Reserved |
| 11 | RO | 0b | Core | Signaled Target-Abort Status (STA): The PT Function will never generate a target abort. Reserved |
| 10:9 | RO | 00b | Core | DEVSEL# Timing Status (DEVT): This field controls the device select time for the PT function's PCI interface. |
| 8 | RO | 0b | Core | Master Data Parity Error Detected) (DPD): PT function (IDER), as a master, does not detect a parity error. Other PT function is not a master and hence this bit is reserved also. |
| 7 | RO | 1b | Core | Fast back to back capable: Reserved |
| 6 | RO | 0b | Core | Reserved |
| 5 | RO | 1b | Core | 66MHz capable: Reserved |
| 4 | RO | 1b | Core | Capabilities List (CL): This bit indicates that there is a capabilities pointer implemented in the device. |
| 3 | RO | 0b | Core | Interrupt Status (IS): This bit reflects the state of the interrupt in the function. Setting of the Interrupt Disable bit to 1 has no affect on this bit. Only when this bit is a 1 and ID bit is 0 is the INTB interrupt asserted to the Host. |
| 2:0 | RO | 000b | Core | Reserved |



10.9.4 RID—Revision ID

B/D/F/Type: 0/3/3/PCI
 Address Offset: 8h
 Default Value: 00hsee description below
 Access: RO
 Size: 8 bits

This register specifies a device specific revision.

| Bit | Access | Default Value | RST/PWR | Description |
|-----|--------|-----------------|---------|---------------------------------------------------------------------------------------------------------------------------------------------------------------------------------|
| 7:0 | RO | see description | Core | Revision ID (RID): This field indicates stepping of the silicon. Refer to the <i>Intel® 4 Series Chipset Family Specification Update</i> for the value of this register. |

10.9.5 CC—Class Codes

B/D/F/Type: 0/3/3/PCI
 Address Offset: 9-Bh
 Default Value: 070002h
 Access: RO
 Size: 24 bits

This register identifies the basic functionality of the device ie Serial Com Port.

| Bit | Access | Default Value | RST/PWR | Description |
|------|--------|---------------|---------|----------------------------------------------------|
| 23:0 | RO | 070002h | Core | Programming Interface BCC SCC (PI BCC SCC): |

10.9.6 CLS—Cache Line Size

B/D/F/Type: 0/3/3/PCI
 Address Offset: Ch
 Default Value: 00h
 Access: RO
 Size: 8 bits

This register defines the system cache line size in DWORD increments. Mandatory for master which use the Memory-Write and Invalidate command.

| Bit | Access | Default Value | RST/PWR | Description |
|-----|--------|---------------|---------|------------------------------------------------------------------------------|
| 7:0 | RO | 00h | Core | Cache Line Size (CLS): All writes to system memory are Memory Writes. |



10.9.7 MLT—Master Latency Timer

B/D/F/Type: 0/3/3/PCI
Address Offset: Dh
Default Value: 00h
Access: RO
Size: 8 bits

This register defines the minimum number of PCI clocks the bus master can retain ownership of the bus whenever it initiates new transactions.

| Bit | Access | Default Value | RST/PWR | Description |
|-----|--------|---------------|---------|----------------------------------------------------------------------------------|
| 7:0 | RO | 00h | Core | Master Latency Timer (MLT): Not implemented since the function is in MCH. |

10.9.8 HTYPE—Header Type

B/D/F/Type: 0/3/3/PCI
Address Offset: Eh
Default Value: < Not Defined >
Access: < Not Defined >
Size: 8 bits

Register is Not implemented. Reads return 0.

10.9.9 BIST—Built In Self Test

B/D/F/Type: 0/3/3/PCI
Address Offset: Fh
Default Value: Not Defined
Access: Not Defined
Size: 8 bits

This optional register is not implemented.



10.9.10 KTIBA—KT IO Block Base Address

B/D/F/Type: 0/3/3/PCI
 Address Offset: 10-13h
 Default Value: 00000001h
 Access: RO, R/W
 Size: 32 bits

Reset: Host system Reset or D3->D0 transition.

Base Address for the 8byte IO space for KT.

| Bit | Access | Default Value | RST/PWR | Description |
|-------|--------|---------------|---------|-----------------------------------------------------------------------------------------------------------------|
| 31:16 | RO | 0000h | Core | Reserved |
| 15:3 | R/W | 0000h | Core | Base Address (BAR): This field provides the base address of the I/O space (8 consecutive I/O locations). |
| 2:1 | RO | 00b | Core | Reserved |
| 0 | RO | 1b | Core | Resource Type Indicator (RTE): This bit indicates a request for I/O space |

10.9.11 KTMBA—KT Memory Block Base Address

B/D/F/Type: 0/3/3/PCI
 Address Offset: 14-17h
 Default Value: 00000000h
 Access: RO, R/W
 Size: 32 bits

Reset: Host system Reset or D3->D0 transition

Base Address of Memory Mapped space.

| Bit | Access | Default Value | RST/PWR | Description |
|-------|--------|---------------|---------|--------------------------------------------------------------------------------------------------------------------------------------------|
| 31:12 | R/W | 00000h | Core | Base Address (BAR): This field provides the base address for Memory Mapped I,O BAR. Bits 31:12 correspond to address signals 31:12. |
| 11:4 | RO | 00h | Core | Reserved |
| 3 | RO | 0b | Core | Prefetchable (PF): This bit indicates that this range is not pre-fetchable. |
| 2:1 | RO | 00b | Core | Type (TP): This field indicates that this range can be mapped anywhere in 32-bit address space. |
| 0 | RO | 0b | Core | Resource Type Indicator (RTE): This bit indicates a request for register memory space. |



10.9.12 RSVD—Reserved

B/D/F/Type: 0/3/3/PCI
Address Offset: 18-1Bh
Default Value: 00000000h
Access: RO
Size: 32 bits

| Bit | Access | Default Value | RST/PWR | Description |
|------|--------|---------------|---------|-------------|
| 31:0 | RO | 00000000h | Core | Reserved |

10.9.13 RSVD—Reserved

B/D/F/Type: 0/3/3/PCI
Address Offset: 1C-1Fh
Default Value: 00000000h
Access: RO
Size: 32 bits

| Bit | Access | Default Value | RST/PWR | Description |
|------|--------|---------------|---------|-------------|
| 31:0 | RO | 00000000h | Core | Reserved |

10.9.14 RSVD—Reserved

B/D/F/Type: 0/3/3/PCI
Address Offset: 20-23h
Default Value: 00000000h
Access: RO
Size: 32 bits

| Bit | Access | Default Value | RST/PWR | Description |
|------|--------|---------------|---------|-------------|
| 31:0 | RO | 00000000h | Core | Reserved |

10.9.15 RSVD—Reserved

B/D/F/Type: 0/3/3/PCI
Address Offset: 24-28h
Default Value: 0000000000h
Access: RO
Size: 40 bits
BIOS Optimal Default 00h

| Bit | Access | Default Value | RST/PWR | Description |
|-------|--------|---------------|---------|-------------|
| 39:32 | RO | 0h | | Reserved |
| 31:0 | RO | 00000000h | Core | Reserved |



10.9.16 SS—Sub System Identifiers

B/D/F/Type: 0/3/3/PCI
 Address Offset: 2C-2Fh
 Default Value: 00008086h
 Access: R/WO
 Size: 32 bits

Reset: Host system Reset

These registers are used to uniquely identify the add-in card or the subsystem that the device resides within.

| Bit | Access | Default Value | RST/PWR | Description |
|-------|--------|---------------|---------|-------------------------------------------------------------------------------------------------------|
| 31:16 | R/WO | 0000h | Core | Subsystem ID (SSID) : This is written by BIOS. No hardware action taken on this value. |
| 15:0 | R/WO | 8086h | Core | Subsystem Vendor ID (SSVID) : This is written by BIOS. No hardware action taken on this value. |

10.9.17 EROM—Expansion ROM Base Address

B/D/F/Type: 0/3/3/PCI
 Address Offset: 30-33h
 Default Value: 00000000h
 Access: RO
 Size: 32 bits

This optional register is not implemented.

| Bit | Access | Default Value | RST/PWR | Description |
|-------|--------|---------------|---------|---------------------------------------------------|
| 31:11 | RO | 000000h | Core | Expansion ROM Base Address (ERBAR) : |
| 10:1 | RO | 000h | Core | Reserved |
| 0 | RO | 0b | Core | Enable (EN) : Enable expansion ROM Access. |

10.9.18 CAP—Capabilities Pointer

B/D/F/Type: 0/3/3/PCI
 Address Offset: 34h
 Default Value: C8h
 Access: RO
 Size: 8 bits

This optional register is used to point to a linked list of new capabilities implemented by the device.

| Bit | Access | Default Value | RST/PWR | Description |
|-----|--------|---------------|---------|------------------------------------------------------------------------------------------------------------------------------------------|
| 7:0 | RO | c8h | Core | Capability Pointer (CP) : This field indicates that the first capability pointer is offset C8h (the power management capability). |



10.9.19 INTR—Interrupt Information

B/D/F/Type: 0/3/3/PCI
 Address Offset: 3C-3Dh
 Default Value: 0200h
 Access: R/W, RO
 Size: 16 bits

Reset: Host System Reset or D3->D0 reset of the function.

See individual Registers below.

| Bit | Access | Default Value | RST/PWR | Description |
|------|--------|---------------|---------|------------------------------------------------------------------------------------------------------------------------------------------------------------------------------------------------------------------------------------------------------------|
| 15:8 | RO | 02h | Core | Interrupt Pin (IPIN): A value of 0x1/0x2/0x3/0x4 indicates that this function implements legacy interrupt on INTA/INTB/INTC/INTD, respectively Function Value INTx (3 KT/Serial Port) 02h INTB |
| 7:0 | R/W | 00h | Core | Interrupt Line (ILINE): The value written in this register tells which input of the system interrupt controller, the device's interrupt pin is connected to. This value is used by the OS and the device driver, and has no affect on the hardware. |

10.9.20 MGNT—Minimum Grant

B/D/F/Type: 0/3/3/PCI
 Address Offset: 3Eh
 Default Value: 00h
 Access: RO
 Size: 8 bits

This optional register is not implemented

| Bit | Access | Default Value | RST/PWR | Description |
|-----|--------|---------------|---------|-------------|
| 7:0 | RO | 00h | Core | Reserved |

10.9.21 MLAT—Maximum Latency

B/D/F/Type: 0/3/3/PCI
 Address Offset: 3Fh
 Default Value: 00h
 Access: RO
 Size: 8 bits

This optional register is not implemented.

| Bit | Access | Default Value | RST/PWR | Description |
|-----|--------|---------------|---------|-------------|
| 7:0 | RO | 00h | Core | Reserved |



10.9.22 PID—PCI Power Management Capability ID

B/D/F/Type: 0/3/3/PCI
 Address Offset: C8-C9h
 Default Value: D001h
 Access: RO
 Size: 16 bits

See register definitions below.

| Bit | Access | Default Value | RST/PWR | Description |
|------|--------|---------------|---------|----------------------------------------------------------------------------------------|
| 15:8 | RO | D0h | Core | Next Capability (NEXT): A value of D0h points to the MSI capability. |
| 7:0 | RO | 01h | Core | Cap ID (CID): This field indicates that this pointer is a PCI power management. |

10.9.23 PC—PCI Power Management Capabilities

B/D/F/Type: 0/3/3/PCI
 Address Offset: CA-CBh
 Default Value: 0023h
 Access: RO
 Size: 16 bits

This register implements the power management capabilities of the function.

| Bit | Access | Default Value | RST/PWR | Description |
|-------|--------|---------------|---------|---------------------------------------------------------------------------------------------------------------------|
| 15:11 | RO | 00000b | Core | PME Support (PME): This field indicates no PME# in the PT function. |
| 10 | RO | 0b | Core | D2 Support (D2S): The D2 state is not Supported |
| 9 | RO | 0b | Core | D1 Support (D1S): The D1 state is not supported |
| 8:6 | RO | 000b | Core | Aux Current (AUXC): PME# from D3 (cold) state is not supported; therefore, this field is 000b. |
| 5 | RO | 1b | Core | Device Specific Initialization (DSI): This bit indicates that no device-specific initialization is required. |
| 4 | RO | 0b | Core | Reserved |
| 3 | RO | 0b | Core | PME Clock (PMEC): This bit indicates that PCI clock is not required to generate PME# |
| 2:0 | RO | 011b | Core | Version (VS): This field indicates support for the <i>PCI Power Management Specification, Revision 1.2</i> . |



10.9.24 PMCS—PCI Power Management Control and Status

B/D/F/Type: 0/3/3/PCI
 Address Offset: CC-CFh
 Default Value: 00000000h
 Access: RO/V, RO, R/W
 Size: 32 bits
 BIOS Optimal Default 0000h

Reset: Host System Reset or D3->D0 transition

This register implements the PCI PM Control and Status Register to allow PM state transitions and Wake up

Note: NSR bit of this register. All registers (PCI configuration and Device Specific) marked with D3->D0 transition reset will only do so if the NSR bit reads a 0. If this bit is a 1, the D3->D0 transition will not reset the registers.

| Bit | Access | Default Value | RST/PWR | Description |
|-------|--------|---------------|---------|----------------------------------------------------------------------------------------------------------------------------------------------------------------------------------------------------------------------------------------------------------------------------------------------------------------------------------------------------------------------------------------------------------------------------------------------------------------------------------------------------------------------------------------------------------------------------------------------------------------------------------------------------------------------------------------------------------------------------------------------------------------------------------------------------------------------------------------------------------------------------------------------------------------------------------------------|
| 31:16 | RO | 0h | | Reserved |
| 15 | RO | 0b | Core | PME Status (PMES): This bit is set when a PME event is to be requested. Not supported |
| 14:9 | RO | 00h | Core | Reserved |
| 8 | RO | 0b | Core | PME Enable (PMEE): Not Supported |
| 7:4 | RO | 0h | Core | Reserved |
| 3 | RO/V | 0b | Core | No Soft Reset (NSR): When set to 1, this bit indicates that devices transitioning from D3hot to D0 because of PowerState commands do not perform an internal reset. Configuration Context is preserved. Upon transition from the D3hot to the D0 Initialized state, no additional operating system intervention is required to preserve Configuration Context beyond writing the PowerState bits. When clear to 0, devices do perform an internal reset upon transitioning from D3hot to D0 via software control of the PowerState bits. Configuration Context is lost when performing the soft reset. Upon transition from the D3hot to the D0 state, full re-initialization sequence is needed to return the device to D0 Initialized. Value in this bit is reflects chicken bit in ME-AUX register x13900, bit [6] which is as follows: 0 = Device performs internal reset 1 = Device does not perform internal reset |
| 2 | RO | 0b | Core | Reserved |
| 1:0 | R/W | 00b | Core | Power State (PS): This field is used both to determine the current power state of the PT function and to set a new power state. The values are: 00 = D0 state 11 = D3 _{HOT} state When in the D3 _{HOT} state, the controller's configuration space is available, but the I/O and memory spaces are not. Additionally, interrupts are blocked. If software attempts to write a '10' or '01' to these bits, the write will be ignored. |



10.9.25 MID—Message Signaled Interrupt Capability ID

B/D/F/Type: 0/3/3/PCI
 Address Offset: D0-D1h
 Default Value: 0005h
 Access: RO
 Size: 16 bits

Message Signalled Interrupt is a feature that allows the device/function to generate an interrupt to the host by performing a DWORD memory write to a system specified address with system specified data. This register is used to identify and configure an MSI capable device.

| Bit | Access | Default Value | RST/PWR | Description |
|------|--------|---------------|---------|----------------------------------------------------------------------------------------------------------------|
| 15:8 | RO | 00h | Core | Next Pointer (NEXT): This value indicates this is the last item in the list. |
| 7:0 | RO | 05h | Core | Capability ID (CID): This field value of Capabilities ID indicates device is capable of generating MSI. |

10.9.26 MC—Message Signaled Interrupt Message Control

B/D/F/Type: 0/3/3/PCI
 Address Offset: D2-D3h
 Default Value: 0080h
 Access: RO, R/W
 Size: 16 bits

Reset: Host System Reset or D3->D0 transition.

This register provides System Software control over MSI.

| Bit | Access | Default Value | RST/PWR | Description |
|------|--------|---------------|---------|--------------------------------------------------------------------------------------------------------------------------------------------|
| 15:8 | RO | 00h | Core | Reserved |
| 7 | RO | 1b | Core | 64 Bit Address Capable (C64): Capable of generating 64-bit and 32-bit messages. |
| 6:4 | R/W | 000b | Core | Multiple Message Enable (MME): These bits are R/W for software compatibility, but only one message is ever sent by the PT function. |
| 3:1 | RO | 000b | Core | Multiple Message Capable (MMC): Only one message is required. |
| 0 | R/W | 0b | Core | MSI Enable (MSIE): If set, MSI is enabled and traditional interrupt pins are not used to generate interrupts. |



10.9.27 MA—Message Signaled Interrupt Message Address

B/D/F/Type: 0/3/3/PCI
Address Offset: D4-D7h
Default Value: 00000000h
Access: RO, R/W
Size: 32 bits

Reset: Host system Reset or D3->D0 transition

This register specifies the DWORD aligned address programmed by system software for sending MSI.

| Bit | Access | Default Value | RST/PWR | Description |
|------|--------|---------------|---------|-----------------------------------------------------------------------------------------------------|
| 31:2 | R/W | 00000000h | Core | Address (ADDR): Lower 32 bits of the system specified message address, always DWord aligned. |
| 1:0 | RO | 00b | Core | Reserved |

10.9.28 MAU—Message Signaled Interrupt Message Upper Address

B/D/F/Type: 0/3/3/PCI
Address Offset: D8-DBh
Default Value: 00000000h
Access: RO, R/W
Size: 32 bits

Reset: Host system Reset or D3->D0 transition

Upper 32 bits of the message address for the 64bit address capable device.

| Bit | Access | Default Value | RST/PWR | Description |
|------|--------|---------------|---------|------------------------------------------------------------------------------|
| 31:4 | RO | 0000000h | Core | Reserved |
| 3:0 | R/W | 0000b | Core | Address (ADDR): Upper 4 bits of the system specified message address. |

10.9.29 MD—Message Signaled Interrupt Message Data

B/D/F/Type: 0/3/3/PCI
Address Offset: DC-DDh
Default Value: 0000h
Access: R/W
Size: 16 bits

Reset: Host system Reset or D3->D0 transition

This 16-bit field is programmed by system software if MSI is enabled

| Bit | Access | Default Value | RST/PWR | Description |
|------|--------|---------------|---------|----------------------------------------------------------------------------------------------------------------------|
| 15:0 | R/W | 0000h | Core | Data (DATA): This MSI data is driven onto the lower word of the data bus of the MSI memory write transaction. |

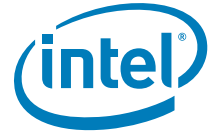

10.10 KT IO/ Memory Mapped Device Registers

Table 25. KT IO/ Memory Mapped Device Register Address Map

| Address Offset | Register Symbol | Register Name | Default Value | Access |
|----------------|-----------------|--------------------------------------|---------------|-------------|
| 0h | KTRxBR | KT Receive Buffer Register | 00h | RO/V |
| 0h | KTTHR | KT Transmit Holding Register | 00h | WO |
| 0h | KTDLLR | KT Divisor Latch LSB Register | 00h | R/W/V |
| 1h | KTIER | KT Interrupt Enable register | 00h | R/W/V, RO/V |
| 1h | KTDLMR | KT Divisor Latch MSB Register | 00h | R/W/V |
| 2h | KTIIR | KT Interrupt Identification register | 01h | RO |
| 2h | KTFCR | KT FIFO Control register | 00h | WO |
| 3h | KTLCR | KT Line Control register | 03h | R/W |
| 4h | KTMCR | KT Modem Control register | 00h | RO, R/W |
| 5h | KTLSR | KT Line Status register | 00h | RO, RO/CR |
| 6h | KTMSR | KT Modem Status register | 00h | RO, RO/CR |
| 7h | KTSCR | KT Scratch register | 00h | R/W |

10.10.1 KTRxBR—KT Receive Buffer Register

B/D/F/Type: 0/3/3/KT MM/IO
 Address Offset: 0h
 Default Value: 00h
 Access: RO/V
 Size: 8 bits

Reset: Host System Reset or D3->D0 transition.

This implements the KT Receiver Data register. Host access to this address, depends on the state of the DLAB bit {KTLCR[7]}. It must be "0" to access the KTRxBR.

RxBR:

Host reads this register when FW provides it the receive data in non-FIFO mode. In FIFO mode, host reads to this register translate into a read from ME memory (RBR FIFO).

| Bit | Access | Default Value | RST/PWR | Description |
|-----|--------|---------------|---------|--------------------------------------------------------------------------------------------------------------------------------------------------------------|
| 7:0 | RO/V | 00h | Core | Receiver Buffer Register (RBR): Implements the Data register of the Serial Interface. If the Host does a read, it reads from the Receive Data Buffer. |

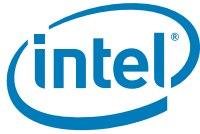

10.10.2 KTTHR—KT Transmit Holding Register

B/D/F/Type: 0/3/3/KT MM/IO
 Address Offset: 0h
 Default Value: 00h
 Access: WO
 Size: 8 bits

Reset: Host System Reset or D3->D0 transition.

This implements the KT Transmit Data register. Host access to this address, depends on the state of the DLAB bit {KTLCR[7]}. It must be "0" to access the KTTHR.

THR:

When host wants to transmit data in the non-FIFO mode, it writes to this register. In FIFO mode, writes by host to this address cause the data byte to be written by hardware to ME memory (THR FIFO).

| Bit | Access | Default Value | RST/PWR | Description |
|-----|--------|---------------|---------|------------------------------------------------------------------------------------------------------------------------------------------------------------------------------|
| 7:0 | WO | 00h | Core | Transmit Holding Register (THR): Implements the Transmit Data register of the Serial Interface. If the Host does a write, it writes to the Transmit Holding Register. |

10.10.3 KTDLLR—KT Divisor Latch LSB Register

B/D/F/Type: 0/3/3/KT MM/IO
 Address Offset: 0h
 Default Value: 00h
 Access: R/W/V
 Size: 8 bits

Reset: Host System Reset or D3->D0 transition.

This register implements the KT DLL register. Host can Read/Write to this register only when the DLAB bit (KTLCR[7]) is 1. When this bit is 0, Host accesses the KTTHR or the KTRBR depending on Read or Write.

This is the standard Serial Port Divisor Latch register. This register is only for software compatibility and does not affect performance of the hardware.

| Bit | Access | Default Value | RST/PWR | Description |
|-----|--------|---------------|---------|--------------------------------------------------------------------------------------|
| 7:0 | R/W/V | 00h | Core | Divisor Latch LSB (DLL): Implements the DLL register of the Serial Interface. |

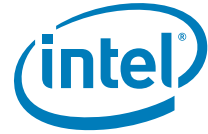

10.10.4 KTIER—KT Interrupt Enable Register

B/D/F/Type: 0/3/3/KT MM/IO
 Address Offset: 1h
 Default Value: 00h
 Access: R/W/V, RO/V
 Size: 8 bits

Reset: Host System Reset or D3 -> D0 transition

This implements the KT Interrupt Enable register. Host access to this address, depends on the state of the DLAB bit {KTLCR[7]}. It must be "0" to access this register. The bits enable specific events to interrupt the Host.

| Bit | Access | Default Value | RST/PWR | Description |
|-----|--------|---------------|---------|---------------------------------------------------------------------------------------------------------------------------------|
| 7:4 | RO/V | 0h | Core | Reserved |
| 3 | R/W/V | 0b | Core | MSR (IER2) : When set, this bit enables bits in the Modem Status register to cause an interrupt to the host. |
| 2 | R/W/V | 0b | Core | LSR (IER1) : When set, this bit enables bits in the Receiver Line Status Register to cause an Interrupt to the Host. |
| 1 | R/W/V | 0b | Core | THR (IER1) : When set, this bit enables an interrupt to be sent to the Host when the transmit Holding register is empty. |
| 0 | R/W/V | 0b | Core | DR (IER0) : When set, the Received Data Ready (or Receive FIFO Timeout) interrupts are enabled to be sent to Host. |

10.10.5 KTDLMR—KT Divisor Latch MSB Register

B/D/F/Type: 0/3/3/KT MM/IO
 Address Offset: 1h
 Default Value: 00h
 Access: R/W/V
 Size: 8 bits

Reset: Host System Reset or D3->D0 transition.

Host can Read/Write to this register only when the DLAB bit (KTLCR[7]) is 1. When this bit is 0, Host accesses the KTIER.

This is the standard Serial interface's Divisor Latch register's MSB. This register is only for SW compatibility and does not affect performance of the hardware.

| Bit | Access | Default Value | RST/PWR | Description |
|-----|--------|---------------|---------|-----------------------------------------------------------------------------------------------------|
| 7:0 | R/W/V | 00h | Core | Divisor Latch MSB (DLM) : Implements the Divisor Latch MSB register of the Serial Interface. |

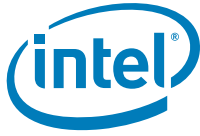

10.10.6 KTIIR—KT Interrupt Identification Register

B/D/F/Type: 0/3/3/KT MM/IO
 Address Offset: 2h
 Default Value: 01h
 Access: RO
 Size: 8 bits

Reset: See specific Bit descriptions.

The KT IIR register prioritizes the interrupts from the function into 4 levels and records them in the IIR_STAT field of the register. When Host accesses the IIR, hardware freezes all interrupts and provides the priority to the Host. Hardware continues to monitor the interrupts but does not change its current indication until the Host read is over. Table in the Host Interrupt Generation section shows the contents.

| Bit | Access | Default Value | RST/PWR | Description |
|-----|--------|---------------|---------|-----------------------------------------------------------------------------------------------------------------------------------------------------------------|
| 7 | RO | 0b | Core | FIFO Enable (FIEN1): This bit is connected by hardware to bit 0 in the FCR register. Reset: Host System Reset or D3->D0 transition. |
| 6 | RO | 0b | Core | FIFO Enable (FIEN0): This bit is connected by hardware to bit 0 in the FCR register. Reset: Host System Reset or D3->D0 transition. |
| 5:4 | RO | 00b | Core | Reserved |
| 3:1 | RO | 000b | Core | IIR STATUS (IIRSTS): These bits are asserted by the hardware according to the source of the interrupt and the priority level. Reset: ME system Reset. |
| 0 | RO | 1b | Core | Interrupt Status (INTSTS): 0 = Pending interrupt to Host 1 = No pending interrupt to Host Reset: Host system Reset or D3->D0 transition |



10.10.7 KTFPCR—KT FIFO Control Register

B/D/F/Type: 0/3/3/KT MM/IO
 Address Offset: 2h
 Default Value: 00h
 Access: WO
 Size: 8 bits

Reset: Host System Reset or D3->D0 transition

When Host writes to this address, it writes to the KTFPCR. The FIFO control Register of the serial interface is used to enable the FIFOs, set the receiver FIFO trigger level and clear FIFOs under the direction of the Host.

When Host reads from this address, it reads the KTIIR.

| Bit | Access | Default Value | RST/PWR | Description |
|-----|--------|---------------|---------|----------------------------------------------------------------------------------------------------------------------------------------------------------------------------------------------------------------|
| 7:6 | WO | 00b | Core | Receiver Trigger Level (RTL): Trigger level in bytes for the RCV FIFO. Once the trigger level number of bytes is reached, an interrupt is sent to the Host. 00 = 01 01 = 04 10 = 08 11 = 14 |
| 5:4 | WO | 00b | Core | Reserved |
| 3 | WO | 0b | Core | RDY Mode (RDYM): This bit has no affect on hardware performance. |
| 2 | WO | 0b | Core | XMT FIFO Clear (XFIC): When the Host writes one to this bit, the hardware will clear the XMT FIFO. This bit is self-cleared by hardware. |
| 1 | WO | 0b | Core | RCV FIFO Clear (RFIC): When the Host writes one to this bit, the hardware will clear the RCV FIFO. This bit is self-cleared by hardware. |
| 0 | WO | 0b | Core | FIFO Enable (FIE): When set, this bit indicates that the KT interface is working in FIFO mode. When this bit value is changed the RCV and XMT FIFO are cleared by hardware. |



10.10.8 KTLCR—KT Line Control Register

B/D/F/Type: 0/3/3/KT MM/IO
Address Offset: 3h
Default Value: 03h
Access: R/W
Size: 8 bits

Reset: Host System Reset or D3->D0 transition.

The line control register specifies the format of the asynchronous data communications exchange and sets the DLAB bit. Most bits in this register have no affect on hardware and are only used by the FW.

| Bit | Access | Default Value | RST/PWR | Description |
|-----|--------|---------------|---------|--------------------------------------------------------------------------------------------------------------------------------------------------------------------------------------------------------------------------------------------------------------------------------------|
| 7 | R/W | 0b | Core | Divisor Latch Address Bit (DLAB): This bit is set when the Host wants to read/write the Divisor Latch LSB and MSB Registers. This bit is cleared when the Host wants to access the Receive Buffer Register or the Transmit Holding Register or the Interrupt Enable Register. |
| 6 | R/W | 0b | Core | Break Control (BC): This bit has no affect on hardware. |
| 5:4 | R/W | 00b | Core | Parity Bit Mode (PBM): This bit has no affect on hardware. |
| 3 | R/W | 0b | Core | Parity Enable (PE): This bit has no affect on hardware. |
| 2 | R/W | 0b | Core | Stop Bit Select (SBS): This bit has no affect on hardware. |
| 1:0 | R/W | 11b | Core | Word Select Byte (WSB): This bit has no affect on hardware. |



10.10.9 KTMCR—KT Modem Control Register

B/D/F/Type: 0/3/3/KT MM/IO
 Address Offset: 4h
 Default Value: 00h
 Access: RO, R/W
 Size: 8 bits

Reset: Host system Reset or D3->D0 transition.

The Modem Control Register controls the interface with the modem. Since the FW emulates the modem, the Host communicates to the FW via this register. Register has impact on hardware when the Loopback mode is on.

| Bit | Access | Default Value | RST/PWR | Description |
|-----|--------|---------------|---------|--------------------------------------------------------------------------------------------------------------------------------------------------------------------------------------------------------------------------------|
| 7:5 | RO | 000b | Core | Reserved |
| 4 | R/W | 0b | Core | Loop Back Mode (LBM): When set by the Host, this bit indicates that the serial port is in loop Back mode. This means that the data that is transmitted by the host should be received. Helps in debug of the interface. |
| 3 | R/W | 0b | Core | Output 2 (OUT2): This bit has no affect on hardware in normal mode. In loop back mode the value of this bit is written by hardware to the Modem Status Register bit 7. |
| 2 | R/W | 0b | Core | Output 1 (OUT1): This bit has no affect on hardware in normal mode. In loop back mode the value of this bit is written by hardware to Modem Status Register bit 6. |
| 1 | R/W | 0b | Core | Request to Send Out (RTSO): This bit has no affect on hardware in normal mode. In loopback mode, the value of this bit is written by hardware to Modem Status Register bit 4. |
| 0 | R/W | 0b | Core | Data Terminal Ready Out (DRTO): This bit has no affect on hardware in normal mode. In loopback mode, the value in this bit is written by hardware to Modem Status Register Bit 5. |

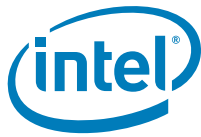

10.10.10 KTLR—KT Line Status Register

B/D/F/Type: 0/3/3/KT MM/IO
 Address Offset: 5h
 Default Value: 00h
 Access: RO, RO/CR
 Size: 8 bits

Reset: Host system reset or D3->D0 transition

This register provides status information of the data transfer to the Host. Error indication, etc. are provided by the HW/FW to the host via this register.

| Bit | Access | Default Value | RST/PWR | Description |
|-----|--------|---------------|---------|-------------------------------------------------------------------------------------------------------------------------------------------------------------------------------------------------------------------------------------------------------------------------------------------------------------------------------------------------------------------------------------------------------------------------------------------------------------------------------------------------------------------------------------------------------------------------------------------------------------------|
| 7 | RO | 0b | Core | RX FIFO Error (RXFER): This bit is cleared in non FIFO mode. This bit is connected to BI bit in FIFO mode. |
| 6 | RO | 0b | Core | Transmit Shift Register Empty (TEMT): This bit is connected by HW to bit 5 (THRE) of this register. |
| 5 | RO | 0b | Core | Transmit Holding Register Empty (THRE): This bit is always set when the mode (FIFO/Non-FIFO) is changed by the Host. This bit is active only when the THR operation is enabled by the FW. This bit has acts differently in the different modes: Non FIFO: This bit is cleared by hardware when the Host writes to the THR registers and set by hardware when the FW reads the THR register. FIFO mode: This bit is set by hardware when the THR FIFO is empty, and cleared by hardware when the THR FIFO is not empty. This bit is reset on Host system reset or D3->D0 transition. |
| 4 | RO/CR | 0b | Core | Break Interrupt (BI): This bit is cleared by hardware when the LSR register is being read by the Host. This bit is set by hardware in two cases: <ul style="list-style-type: none"> In FIFO mode the FW sets the BI bit by setting the SBI bit in the KTRIVR register (See KT AUX registers) In non-FIFO mode the FW sets the BI bit by setting the BIA bit in the KTRxBR register (see KT AUX registers) |
| 3 | RO | 0b | Core | Framing Error (FE): This bit is not implemented |
| 2 | RO | 0b | Core | Parity Error (PE): This bit is not implemented |
| 1 | RO/CR | 0b | Core | Overrun Error (OE): This bit is cleared by hardware when the LSR register is being read by the Host. The FW typically sets this bit, but it is cleared by hardware when the host reads the LSR. |
| 0 | RO | 0b | Core | Data Ready (DR): Non-FIFO Mode: This bit is set when the FW writes to the RBR register and cleared by hardware when the RBR register is being Read by the Host. FIFO Mode: This bit is set by hardware when the RBR FIFO is not empty and cleared by hardware when the RBR FIFO is empty. This bit is reset on Host System Reset or D3->D0 transition. |

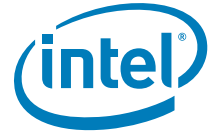

10.10.11 KTMSR—KT Modem Status Register

B/D/F/Type: 0/3/3/KT MM/IO
 Address Offset: 6h
 Default Value: 00h
 Access: RO, RO/CR
 Size: 8 bits

Reset: Host system Reset or D3->D0 transition

The functionality of the Modem is emulated by the FW. This register provides the status of the current state of the control lines from the modem.

| Bit | Access | Default Value | RST/PWR | Description |
|-----|--------|---------------|---------|-------------------------------------------------------------------------------------------------------------------------------------------------------------------------------------------|
| 7 | RO | 0b | Core | Data Carrier Detect (DCD) : In Loop Back mode this bit is connected by hardware to the value of MCR bit 3. |
| 6 | RO | 0b | Core | Ring Indicator (RI) : In Loop Back mode this bit is connected by hardware to the value of MCR bit 2. |
| 5 | RO | 0b | Core | Data Set Ready (DSR) : In Loop Back mode this bit is connected by hardware to the value of MCR bit 0. |
| 4 | RO | 0b | Core | Clear To Send (CTS) : In Loop Back mode this bit is connected by hardware to the value of MCR bit 1. |
| 3 | RO/CR | 0b | Core | Delta Data Carrier Detect (DDCD) : This bit is set when bit 7 is changed. This bit is cleared by hardware when the MSR register is being read by the HOST driver. |
| 2 | RO/CR | 0b | Core | Trailing Edge of Read Detector (TERI) : This bit is set when bit 6 is changed from 1 to 0. This bit is cleared by hardware when the MSR register is being read by the Host driver. |
| 1 | RO/CR | 0b | Core | Delta Data Set Ready (DDSR) : This bit is set when bit 5 is changed. This bit is cleared by hardware when the MSR register is being read by the Host driver. |
| 0 | RO/CR | 0b | Core | Delta Clear To Send (DCTS) : This bit is set when bit 4 is changed. This bit is cleared by hardware when the MSR register is being read by the Host driver. |

10.10.12 KTSCR—KT Scratch Register

B/D/F/Type: 0/3/3/KT MM/IO
 Address Offset: 7h
 Default Value: 00h
 Access: R/W
 Size: 8 bits

Reset: Host system reset or D3->D0 transition

This register has no affect on hardware. This is for the programmer to hold data temporarily.

| Bit | Access | Default Value | RST/PWR | Description |
|-----|--------|---------------|---------|---------------------------------------|
| 7:0 | R/W | 00h | Core | Scratch Register Data (SCRD) : |

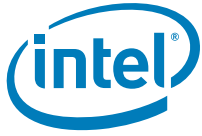

§ §

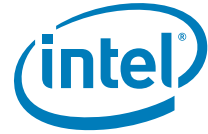

11 Intel® Trusted Execution Technology Registers (Intel® 82Q45 and 82Q43 GMCH Only)

This section covers the Intel® Trusted Execution Technology specific registers implemented in the (G)MCH. For more information on Intel® Trusted Execution Technology enabled platform, refer to the Intel® Trusted Execution Technology BIOS writer's guide.

11.1 Intel Trusted Execution Technology Specific Registers

| Address Offset | Symbol | Register Name | Srlz | Default Value | Access |
|----------------|----------------------------------|--------------------------------------------------|------|-----------------------|---------|
| 0h | TXT.STS | TXT Status Register | | 000010h | RO |
| 8h | TXT.ESTS | TXT Error Status Register | | 00h | RWC, RO |
| 10–17h | TXT.THREAD.EXISTS | TXT Thread Exists Register | | 000000000000 0000h | RO |
| 20–27h | TXT.THREADS.JOIN | TXT Threads Join Register | | 000000000000 0000h | RO |
| 30–33h | TXT.ERRORCODE (AKA TXT.CRASH) | TXT ERRORCODE Register (Also known as TXT CRASH) | | 00000000h | RWC |
| 38–3Fh | TXT.CMD.RESET | TXT System Reset Command | FA | N/A | WO |
| 48–4Fh | TXT.CMD.CLOSE-PRIVATE | TXT Close Private Command | | N/A | WO |
| 110–117h | TXT.DID | TXT Device ID Register | | 8003h | RW, RO |
| 258–25Fh | TXT.CMD.FLUSH-WB | TXT Flush Write Buffer Command | FA | N/A | WO |
| 270–277h | TXT.SINIT.MEMORY.BASE | TXT SINIT Code Base Register | | 000000000000 0000h | RW, RO |
| 278–27Fh | TXT.SINIT.MEMORY.SIZE | TXT SINIT Memory Size Register | | 000000000000 0000h | RW, |
| 290–297h | TXT.MLE.JOIN | TXT MLE Join Base Register | | 000000000000 0000h | RW, RO |
| 300–307h | TXT.HEAP.BASE | TXT Heap Base Register | | 000000000000 0000h | RW |
| 308–30Fh | TXT.HEAP.SIZE | TXT Heap Size Register | | 000000000000 0000h | RW |
| 310–317h | TXT.MSEG.BASE | TXT MSEG Base Register | | 000000000000 0000h | RW/L |



| Address Offset | Symbol | Register Name | Srlz | Default Value | Access |
|----------------|-------------------------|------------------------------------|------|---------------------------------------------------------------|---------------------|
| 318–31Fh | TXT.MSEG.SIZE | TXT MSEG Size Address Register | | 000000000000 0000h | RW/L |
| 320–327h | TXT.SCRATCHPAD.0 | TXT Scratch Pad 0 Register | | 000000000000 0000h | RW |
| 328–32Fh | TXT.SCRATCHPAD.1 | TXT Scratch Pad 1 Register | | 000000000000 0000h | RW |
| 330–337h | TXT.DPR | DMA Protected Range | | 000000000000 0000h | RO, RW/L, RWO |
| 380–387h | TXT.CMD.OPEN.LOCALITY1 | TXT Open Locality 1 Command | FA | N/A | WO |
| 388–38Fh | TXT.CMD.CLOSE.LOCALITY1 | TXT Close Locality 1 Command | FA | N/A | WO |
| 390–397h | TXT.CMD.OPEN.LOCALITY2 | TXT Open Locality 2 Command | FA | N/A | WO |
| 398–39Fh | TXT.CMD.CLOSE.LOCALITY2 | TXT Close Locality 2 Command | FA | N/A | WO |
| 400–41Fh | TXT.PUBLIC.KEY | TXT Chipset Public Key Hash | | 00000000de44 98a3619fa4f4e 5e30200613d4 a51a6f9e712h | RO |
| 8E0–8E7h | TXT.CMD.SECRETS | TXT Secrets Command | FA | N/A | WO |
| 8E8–8EFh | TXT.CMD.NO-SECRETS | TXT No Secrets Command | FA | N/A | WO |
| 8F0–8F7h | TXT.E2STS | TXT Extended Error Status Register | | 000000000000 0000h | RO |

Note: **Srlz:** Indicates if a serializing step is required by software (for example, a read) before or after a write to the register. Note that this is referring to serializing at the chipset hardware level. Since TXT space is memory-mapped, multiple commands or writes can be enqueued in a back-to-back sequence. If a preceding command or write takes several clocks to be fully processed, the subsequent accesses may be handled incorrectly. Therefore, simply serializing these cycles as they leave the processor may not be sufficient to guarantee that they are appropriately serialized by the time they are processed in the chipset. A read following the write does guarantee that a subsequent write is serialized after the first write. FA=Fence after. FB=Fence before.



11.1.1 TXT.STS—TXT Status Register

B/D/F/Type: 0/0/0/TXT Specific
 Address Offset: 0-2h
 Default Value: 000010h
 Access: RO
 Size: 24 bits
 BIOS Optimal Default 00h

This register is used to read the status of the TXT Command/Status Engine functional block in the chipset.

| Bit | Access | Default Value | Description |
|-------|--------|---------------|-------------------------------------------------------------------------------------------------------------------------------------------------------------------------------------------------------------------------------------------------------------------------------------------------------------------------------------------------------------------------------------------------------------------|
| 23:17 | RO | 0h | Reserved |
| 16 | RO | 0b | TXT.LOCALITY2.OPEN.STS (TXT.LOCALITY2.OPEN.STS): This bit is set when either the TXT.CMD.OPEN.LOCALITY2 command or the TXT.CMD.OPEN.PRIVATE is seen by the chipset. It is cleared on reset or when either TXT.CMD.CLOSE.LOCALITY2 or TXT.CMD.CLOSE.PRIVATE is seen. This bit can be used by SW as a positive indication that the command has taken effect. |
| 15 | RO | 0b | TXT.LOCALITY1.OPEN.STS (TXT.LOCALITY1.OPEN.STS): This bit is set when the TXT.CMD.OPEN.LOCALITY1 command is seen by the chipset. It is cleared on reset or when TXT.CMD.CLOSE.LOCALITY1 is seen. This bit can be used by SW as a positive indication that the command has taken effect. |
| 14:8 | RO | 0b | Reserved |
| 7 | RO | 0b | TXT Private-Open Status (TXT.PRIVATE-OPEN.STS): This bit will be set to 1 when the TXT Private address is opened. This bit cleared by the TXT.CMD.CLOSE-PRIVATE or by a system reset. |
| 6:5 | RO | 0b | Reserved |
| 4:4 | RO | 1b | Reserved |
| 3:2 | RO | 0b | Reserved |
| 1 | RO | 0b | SEXIT Done Status (SEXIT.DONE.STS): This bit is set when all of the bits in the TXT.THREADS.JOIN register are clear 0. Thus, this bit will be set immediately after reset (since the bits are all 0). This bit will be cleared on the receipt of the first TXT.CYC.SENTER-ACK. Once all threads have done the TXT.CYC.SEXIT-ACK, the TXT.THREAD.JOIN register will be 0, so the chipset will set this bit. |
| 0 | RO | 0b | SENDER Done Status (SENDER.DONE.STS): The chipset sets this bit when it sees all of the threads have done the TXT.CYC.SENTER-ACK. When any of the threads does the TXT.CYC.SEXIT-ACK, the TXT.THREADS.JOIN and TXT.THREADS.EXISTS registers will not be equal, so the chipset will clear this bit. |

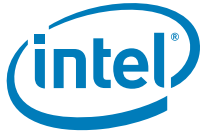

11.1.2 TXT.ESTS—TXT Error Status Register

B/D/F/Type: 0/0/0/TXT Specific
 Address Offset: 8h
 Default Value: 00h
 Access: RWC, RO
 Size: 8 bits

This register is used to read the status associated with various errors that might be detected. All defined bits in this register are sticky.

| Bit | Access | Default Value | Description |
|-----|--------|---------------|----------------------------------------------------------------------------------------------------------------------------------------------------------------------------------------------------------------------------------------------------------------------------------------------------------------------------------------------------------------------------------------------------------------------------------------------------------------------------------------------------------------------------------------------------------------------------------------------------------------------------------------------------------------------------------------------------------------------------------------------------------------------------------------------------------------------------------------------------------------------------------------------------------------------------------------------|
| 7 | RWC | 0b | Reserved |
| 6 | RWC | 0b | <p>TXT Wake Error Status (TXT.WAKE-ERROR.STS): The chipset sets this bit when it detects that there might have been secrets in memory and a reset or power failure occurred.</p> <p>If this bit is set after a system reset, the chipset will prevent memory accesses until specifically enabled. The software that is authorized to enable the memory accesses will also be responsible for clearing the secrets from memory.</p> <p>Software can read chipset-specific registers to determine the specific cause of the error. The location of those bits is beyond the scope of this specification.</p> <p>On a reset, if CPU_RESET_DONE_ACK_SECRET is received, then this bit is set to '1'.</p> <p>On a reset, if CPU_RESET_DONE_ACK is received, then this bit is cleared to '0'.</p> <p>Software can clear this bit by writing a '1' to it.</p> <p>This bit must be cleared if a read to 0xFED4_0000 returns a 1 in bit 0.</p> |
| 5:1 | RWC | 0b | Reserved |
| 0 | RO | 0b | <p>TXT Reset Status (TXT.TXT_RESET.STS): The chipset sets this bit to '1' to indicate that the platform experienced a TXT reset. To maintain TXT integrity, while this bit is set, a TXT measured environment cannot be established; consequently Safer Mode Extension (SMX) instructions GETSEC [ENTERACCS] and GETSEC [SENDER] will fail. See Chapter 6, "Safer Mode Extensions Reference" of Intel® 64 and IA-32 Architectures Software Developer's Manual, Volume 2B.</p> <p>Reads to the TXT public space and other non-SMX instructions will continue to work. This bit must be cleared to re-enable TXT on the platform. Note: This bit is sticky and will only be cleared on a power cycle.</p> |

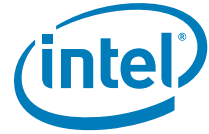

11.1.3 TXT.THREAD.EXISTS—TXT Thread Exists Register

B/D/F/Type: 0/0/0/TXT Specific
 Address Offset: 10-17h
 Default Value: 0000000000000000h
 Access: RO
 Size: 64 bits

This register is used to read which threads are registered as TXT capable

| Bit | Access | Default Value | Description | | | | | | | | | | | | |
|-------|-----------------------|---------------|------------------------------------------------------------------------------------------------------------------------------------------------------------------------------------------------------------------------------------------------------------------------------------------------------------------------------------------------------------------------------------------------------------------------------------------------------------------------------------------------------------------------------------------------------------------------------------------------------------------------------------------------------------------------------------------------------------------------------------------------------------------------------------------------------------------------------------------------------------------------------------------------------------------------------------------------------------------------------------------------------------------------------------------------------------------------------------------------------------------------------------------------------------------------------|------|-------|-----|-----------------------|------|-----------------------|-------|-----------------------|-------|-----------------------|-------|----------|
| 63:32 | RO | 00000000h | <p>TXT Threads Exists (Reserved) (TXT.THRDS.EXISTS_R): This bit field indicates the threads on the FSB that have issued a cycle. The bit is set based on any processor cycle initiated by the thread after reset. The GETSEC instruction is expected to be performed after each thread has performed at least one cycle. When the chipset detects the presence of a particular thread, it sets the corresponding bit in this register.</p> <p>This register is locked when SENTER is seen on the FSB.</p> <p>The following bit mapping is used:</p> <table border="0"> <thead> <tr> <th>Bits</th> <th>Usage</th> </tr> </thead> <tbody> <tr> <td>7:0</td> <td>CPU #0, threads # 1-4</td> </tr> <tr> <td>15:8</td> <td>CPU #1, threads # 1-4</td> </tr> <tr> <td>23:16</td> <td>CPU #2, threads # 1-4</td> </tr> <tr> <td>31:24</td> <td>CPU #3, threads # 1-4</td> </tr> <tr> <td>63:32</td> <td>Reserved</td> </tr> </tbody> </table> <p>NOTES: The processor is defined by the Defer ID bits, DID[6:5]. The thread is defined by ATTR[6:5]. At the moment that defines only 4 processor's and 4 threads. The other bits are reserved for future changes.</p> | Bits | Usage | 7:0 | CPU #0, threads # 1-4 | 15:8 | CPU #1, threads # 1-4 | 23:16 | CPU #2, threads # 1-4 | 31:24 | CPU #3, threads # 1-4 | 63:32 | Reserved |
| Bits | Usage | | | | | | | | | | | | | | |
| 7:0 | CPU #0, threads # 1-4 | | | | | | | | | | | | | | |
| 15:8 | CPU #1, threads # 1-4 | | | | | | | | | | | | | | |
| 23:16 | CPU #2, threads # 1-4 | | | | | | | | | | | | | | |
| 31:24 | CPU #3, threads # 1-4 | | | | | | | | | | | | | | |
| 63:32 | Reserved | | | | | | | | | | | | | | |
| 31:0 | RO | 00000000h | <p>TXT Thread Exists (TXT.THRDS.EXISTS): This bit field indicates the threads on the FSB that have issued a cycle. The bit is set based on any processor cycle initiated by the thread after reset. The GETSEC instruction is expected to be performed after each thread has performed at least one cycle. When the chipset detects the presence of a particular thread, it sets the corresponding bit in this register.</p> <p>This register is locked when SENTER is seen on the FSB.</p> <p>The following bit mapping is used:</p> <table border="0"> <thead> <tr> <th>Bits</th> <th>Usage</th> </tr> </thead> <tbody> <tr> <td>7:0</td> <td>CPU #0, threads # 1-4</td> </tr> <tr> <td>15:8</td> <td>CPU #1, threads # 1-4</td> </tr> <tr> <td>23:16</td> <td>CPU #2, threads # 1-4</td> </tr> <tr> <td>31:24</td> <td>CPU #3, threads # 1-4</td> </tr> <tr> <td>63:32</td> <td>Reserved</td> </tr> </tbody> </table> <p>NOTE: The CPU is defined by the Defer ID bits, DID[6:5]. The thread is defined by ATTR[6:5]. At the moment that defines only 4 processors and 4 threads. The other bits are reserved for future changes.</p> | Bits | Usage | 7:0 | CPU #0, threads # 1-4 | 15:8 | CPU #1, threads # 1-4 | 23:16 | CPU #2, threads # 1-4 | 31:24 | CPU #3, threads # 1-4 | 63:32 | Reserved |
| Bits | Usage | | | | | | | | | | | | | | |
| 7:0 | CPU #0, threads # 1-4 | | | | | | | | | | | | | | |
| 15:8 | CPU #1, threads # 1-4 | | | | | | | | | | | | | | |
| 23:16 | CPU #2, threads # 1-4 | | | | | | | | | | | | | | |
| 31:24 | CPU #3, threads # 1-4 | | | | | | | | | | | | | | |
| 63:32 | Reserved | | | | | | | | | | | | | | |



11.1.4 TXT.THREADS.JOIN—TXT Threads Join Register

B/D/F/Type: 0/0/0/TXT Specific
 Address Offset: 20-27h
 Default Value: 0000000000000000h
 Access: RO
 Size: 64 bits

This register is used to count the threads that have joined the TXT environment.

| Bit | Access | Default Value | Description |
|-------|--------|---------------|---------------------------------------------------------------------------------------------------------------------------------------------------------------------------------------------------------------------------------------------------------------------------------------------------------------------------------------------------------------------------------------------------------------------------------------------------------------------------------------------------------------------------------------------------------------------------------------------------------------------------------------------------------------------------------------------------------------------------------------------------------|
| 63:32 | RO | 00000000h | <p>TXT Threads Join (Reserved) (TXT.THRDS.JOIN_R): This bit field indicates the threads that have issued an SENTER-ACK cycle. Each bit corresponds to a separate thread. When the chipset observes the SENTER-ACK from the thread, it sets the corresponding bit in this register.</p> <p>The format of the bits in this register is the same as in the TXT.THREADS.EXISTS register.</p> <p>The chipset will set the SENTER.DONE.STS bit when the TXT.THREADS.EXISTS and TXT.THREADS.JOIN fields match and at least one bit in the TXT.THREADS.EXISTS register is set.</p> <p>When the chipset observes the SEXIT.ACK cycle, it will clear the corresponding bit in this register. When it has cleared all the bits, it will set SEXIT.DONE.</p> |
| 31:0 | RO | 00000000h | <p>TXT Threads Join (TXT.THRDS.JOIN): This bit field indicates the threads that have issued an SENTER-ACK cycle. Each bit corresponds to a separate thread. When the chipset observes the SENTER-ACK from the thread, it sets the corresponding bit in this register.</p> <p>The format of the bits in this register is the same as in the TXT.THREADS.EXISTS register.</p> <p>The chipset will set the SENTER.DONE.STS bit when the TXT.THREADS.EXISTS and TXT.THREADS.JOIN fields match and at least one bit in the TXT.THREADS.EXISTS register is set.</p> <p>When the chipset observes the SEXIT.ACK cycle, it will clear the corresponding bit in this register. When it has cleared all the bits, it will set SEXIT.DONE.</p> |

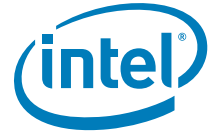

11.1.5 TXT.ERRORCODE (AKA TXT.CRASH)—TXT Error Code Register

B/D/F/Type: 0/0/0/TXT Specific
 Address Offset: 30-33h
 Default Value: 00000000h
 Access: RW
 Size: 32 bits

When software discovers an error, it can write this scratchpad register. The register is NOT reset by a standard reset, and thus allows diagnostic software (after the reset) to determine why the SENTER sequence failed (by examining various status bits). All defined bits in this register are sticky across soft reboot.

| Bit | Access | Default Value | Description |
|------|--------|---------------|---------------------------------------------------------------------------------------|
| 31:0 | RWC | 00000000h | Error Code (CRASH): Default 0 on power-up. Otherwise, previous value on reset. |

11.1.6 TXT.CMD.RESET—TXT System Reset Command

When this command is invoked, the chipset resets the entire platform. Hardware naturally delays the assertion of reset sufficiently such that any previous writes to ERRORCODE register should have completed. If software wants to guarantee that it is not reliant upon this race, it must read back the ERRORCODE register before writing the System Reset Command.

11.1.7 TXT.CMD.CLOSE-PRIVATE—TXT Close Private Command

The processor that authenticates the SEXIT code does this to prevent the TXT Private address space from being accessed using standard memory read/write cycles.

System Software (i.e. MLE - Measured Launched Environment) is required to fence after this command is performed. This can be achieved by reading back the STS flag to see that it is no longer set after performing the CLOSE-PRIVATE command.



11.1.8 TXT.DID—TXT Device ID Register

B/D/F/Type: 0/0/0/TXT Specific
 Address Offset: 110-117h
 Default Value: 8003h
 Access: RW, RO
 Size: 64 bits

Contains the TXT ID for the MCH or root chipset component. This register is Sticky.

| Bit | Access | Default Value | Description |
|-------|--------|------------------------|-----------------------------------------------------------------------------------------------------------------------------------------------------------|
| 63:48 | RW | 0000h | TXT ID Extensions (TXT.ID.EXT): This field is Read/Write. The default value for this register is 0. This is an extension onto the other ID fields. |
| 47:32 | RO | 000000000000 01111b | Revision ID (TXT.RID): |
| 31:16 | RO | 8003h | Device ID (TXT.DID): 8003h for Intel 4 Series Chipset 82Q45 and 82Q43. |
| 15:0 | RO | 8086h | Vendor ID (TXT.VID): This register field contains the PCI standard identification for Intel, 8086h. |

11.1.9 TXT.CMD.FLUSH-WB—TXT Flush Write Buffer Command

This command flushes the chipset write buffers. The MLE writes to this register as part of the MPT update sequence.

11.1.10 TXT.SINIT.MEMORY.BASE—TXT SINIT Code Base Register

B/D/F/Type: 0/0/0/TXT Specific
 Address Offset: 270-277h
 Default Value: 0000000000000000h
 Access: RW, RO
 Size: 64 bits

This register contains the physical base address of the memory region set aside by the BIOS for loading an SINIT AC module. The system software reads this register to locate the SINIT module (which may have been loaded by the BIOS) or to find a location to load the SINIT module.

| Bit | Access | Default Value | Description |
|-------|--------|---------------|------------------------------------------------------------------------------------------------------------------------------------------------------------------------------------------------------------------------------------------------------------------------------------------------------------------------------------------------------------------------------------------------------------------------|
| 63:36 | RO | 0000000h | Reserved |
| 35:12 | RW | 000000h | SINIT Code Base (TXT.SINIT.MEMORY.BASE): Base address of the SINIT code. Hardware does not use the information contained in this register. It is used as a mailbox between two pieces of software. NOTE: Bits 11:0 are not implemented because the SINIT code must be aligned to a 4K page boundary. Systems supporting a 36 bit address space may make bits 63:36 as RO with reads returning '0'. |
| 11:0 | RO | 000h | Reserved |



11.1.11 TXT.SINIT.MEMORY.SIZE—TXT SINIT Memory Size Register

B/D/F/Type: 0/0/0/TXT Specific
 Address Offset: 278-27Fh
 Default Value: 0000000000000000h
 Access: RW
 Size: 64 bits

This register contains the size in bytes of the memory region set aside by the BIOS for loading an SINIT AC module. This register is initialized by the BIOS. The system software may read this register when loading an SINIT module.

| Bit | Access | Default Value | Description |
|------|--------|-----------------------|--------------------------------------------------------------------------------------------------------------------------------------------------------------------------------------------------------------------------------------------------------------------------------------------------------------------------------------------------------------------------------------------------------------|
| 63:0 | RW | 0000000000 000000h | TXT.SINIT.SIZE (TXT.SINIT.SIZE) : Base address of the SINIT code. Hardware does not use the information contained in this register. It is used as a mailbox between two pieces of software. Note: Bits 11:0 are not implemented because the SINIT code must be aligned to a 4K page boundary. Systems supporting a 36 bit address space may make bits 63:36 as RO with reads returning '0'. |

11.1.12 TXT.MLE.JOIN—TXT MLE Join Base Register

B/D/F/Type: 0/0/0/TXT Specific
 Address Offset: 290-297h
 Default Value: 0000000000000000h
 Access: RW, RO
 Size: 64 bits

Holds a physical address pointer to the base of the join data structure referenced by RLPs in response to a GETSEC[WAKEUP] while operating between SENTER and SEXIT.

| Bit | Access | Default Value | Description |
|-------|--------|----------------|------------------------------------------------------------------------------------------------------------------------------------------------------------------------------------------------------|
| 63:36 | RO | 0000000h | TXT MLE Join Base (Reserved) (TXT.MLE.JOIN_R) : Base address of the MLE join code. For chipsets that only support 64GB FSB addressing (36b addressing), bits 63:36 may be RO – reserved(0) |
| 35:0 | RW | 00000000 0h | TXT MLE Join Base (TXT.MLE.JOIN) : Base address of the MLE join code. For chipsets that only support 64 GB FSB addressing (36b addressing), bits 63:36 may be RO – reserved(0) |



11.1.13 TXT.HEAP.BASE—TXT Heap Base Register

B/D/F/Type: 0/0/0/TXT Specific
Address Offset: 300-307h
Default Value: 0000000000000000h
Access: RW
Size: 64 bits

This register contains the physical base address of the TXT Heap memory region. The BIOS initializes this register. The system software and MLE read this register to locate the TXT Heap.

| Bit | Access | Default Value | Description |
|------|--------|-----------------------|---------------------------------------------------------------------------------------------------------------|
| 63:0 | RW | 000000000 0000000h | Heap Base Address (TXT.HEAP.BASE): Base address of the Heap. Systems must implement all 64 bits as RW. |

11.1.14 TXT.HEAP.SIZE—TXT Heap Size Register

B/D/F/Type: 0/0/0/TXT Specific
Address Offset: 308-30Fh
Default Value: 0000000000000000h
Access: RW;
Size: 64 bits

This register contains the size in bytes of the TXT Heap memory region. The BIOS initializes this register. The system software and the MLE read this register to determine the TXT Heap size.

| Bit | Access | Default Value | Description |
|------|--------|-----------------------|---------------------------------------------------------------------------|
| 63:0 | RW | 000000000 0000000h | Heap Size (TXT.HEAP.SIZE): Size of the total Device space in bytes |

11.1.15 TXT.MSEG.BASE—TXT MSEG Base Register

B/D/F/Type: 0/0/0/TXT Specific
Address Offset: 310-317h
Default Value: 0000000000000000h
Access: RW/L
Size: 64 bits

This register provides the base address of MSEG. This register is locked by SMM D_LCK and when locked neither public nor private writes can change its value.

| Bit | Access | Default Value | Description |
|------|--------|-----------------------|----------------------------------------------------------------------------------------|
| 63:0 | RW/L | 000000000 0000000h | MSEG Base Address (MSEG.BASE): BIOS writes the base of MSEG into this register. |



11.1.16 TXT.MSEG.SIZE—TXT MSEG Size Address Register

B/D/F/Type: 0/0/0/TXT Specific
 Address Offset: 318-31Fh
 Default Value: 0000000000000000h
 Access: RW/L
 Size: 64 bits

This register provides the size of MSEG. This register is locked by SMM D_LCK and when locked neither public nor private writes can change its value.

| Bit | Access | Default Value | Description |
|------|--------|-----------------------|-----------------------------------------------------------------------------------|
| 63:0 | RW/L | 0000000000 000000h | MSEG Size Value (MSEG.SIZE): This is the size of the MSEG region in bytes. |

11.1.17 TXT.SCRATCHPAD.0—TXT Scratch Pad 0 Register

B/D/F/Type: 0/0/0/TXT Specific
 Address Offset: 320-327h
 Default Value: 0000000000000000h
 Access: RW
 Size: 64 bits

Scratchpad register 0

| Bit | Access | Default Value | Description |
|------|--------|-----------------------|--------------------------------------------------------|
| 63:0 | RW | 0000000000 000000h | Scratch Pad 0 (SCRATCH0): General Scratch Pad 0 |

11.1.18 TXT.SCRATCHPAD.1—TXT Scratch Pad 1 Register

B/D/F/Type: 0/0/0/TXT Specific
 Address Offset: 328-32Fh
 Default Value: 0000000000000000h
 Access: RW
 Size: 64 bits

Scratchpad register 1

| Bit | Access | Default Value | Description |
|------|--------|-----------------------|--------------------------------------------------------|
| 63:0 | RW | 0000000000 000000h | Scratch Pad 1 (SCRATCH1): General Scratch Pad 1 |



11.1.19 TXT.DPR—DMA Protected Range

B/D/F/Type: 0/0/0/TXT Specific
 Address Offset: 330-337h
 Default Value: 0000000000000000h
 Access: RO, RW/L, RWO
 Size: 64 bits

DMA protected range register.

| Bit | Access | Default Value | Description |
|-------|--------|---------------|----------------------------------------------------------------------------------------------------------------------------------------------------------------------------------------------------------------------------------------------------------------------------------------------------------------------------------------------------------------------------------------------------------------------------------------------------------------------------------------------------------------------------------------------------------------------------------------------------------------------------------------------------------------------------------------------------------------------------------------------------------------------------------------------------------------------------------------------------------------------------------------------------------------------------------------------------------------------------------------------------------------------------------------------------------------------------------------------------------------------------------------------------------------------------------------------------------------------------------------------------------------------------------------------------------------|
| 63:32 | RO | 00000000h | Reserved |
| 31:20 | RO | 000h | Top of DPR (TopOfDPR): Top address + 1 of DPR. This is the base of TSEG. Bits 19:0 of the BASE reported here are 0x0_0000. |
| 19:12 | RO | 00h | Reserved |
| 11:4 | RW/L | 00h | <p>DMA Protected Memory Size (DPR.SIZE): This is the size of memory, in MB, that will be protected from DMA accesses. A value of 0x00 in this field means no additional memory is protected. The maximum amount of memory that will be protected is 255 MB.</p> <p>The amount of memory reported in this field will be protected from all DMA accesses, including translated CPU accesses and graphics. The top of the protected range is the BASE of TSEG-1.</p> <p>NOTE: If TSEG is not enabled, then the top of this range becomes the base of stolen graphics, or ME stolen space or TOLUD, whichever would have been the location of TSEG, assuming it had been enabled.</p> <p>The DPR range works independently of any other range, including the PMRC checks in VTd, and is done post any VTd translation. Therefore, incoming cycles are checked against this range after the VTd translation and faulted if they hit this protected range, even if they passed the VTd translation.</p> <p>All the memory checks are OR'ed with respect to NOT being allowed to go to memory. So if either PMRC, DPR OR a VTd translation disallows the cycle, then the cycle is not allowed to go to memory. Or in other words, all the above checks must pass before a cycle is allowed to DRAM.</p> |
| 3:1 | RO | 000b | Reserved |
| 0 | RWO | 0b | LOCK (LOCK): Bits 19:0 are locked down in this register when this bit is set. |

11.1.20 TXT.CMD.OPEN.LOCALITY1—TXT Open Locality 1 Command

This command will open Locality1 for decode as an TXT space by the chipset. If the locality is closed, then cycles to the locality 1 address range are not decoded as TXT cycles.

Note: PRIVATE space must also be Open for Locality 1 to be decoded as TXT Space.



11.1.21 TXT.CMD.CLOSE.LOCALITY1—TXT Close Locality 1 Command

This command closes the locality 1 address space as an TXT range. When closed, the chipset may decode this range as normal memory space, or it may abort cycles to this range.

11.1.22 TXT.CMD.OPEN.LOCALITY2—TXT Open Locality 2 Command

This command will open Locality2 for decode as an TXT space by the chipset. This command is either an LTMW or a private write when private is open.

Note: OPEN.PRIVATE will open locality 2 and CLOSE.PRIVATE will close locality2. The OPEN/CLOSE locality2 commands are to be used in the window while PRIVATE is open, but the MLE wants to close or re-open the locality 2 space while still leaving PRIVATE open. If the locality is closed, then cycles to the locality 2 address range are not decoded as TXT cycles. PRIVATE space must also be Open for Locality 2 to be decoded as TXT space.

11.1.23 TXT.CMD.CLOSE.LOCALITY2—TXT Close Locality 2 Command

This command closes the locality 2 address space as an TXT range. When closed, the chipset may decode this range as normal memory space, or it may abort cycles to this range. This command is either an LTMW or a private write when private is open.

11.1.24 TXT.PUBLIC.KEY—TXT Chipset Public Key Hash

B/D/F/Type: 0/0/0/TXT Specific
 Address Offset: 400-41Fh
 Default Value: 00000000de4498a3619fa4f4e5e30200613d4a51a6f9e712h
 Access: RO
 Size: 256 bits

These registers hold the hash of the chipset's public key.

| Bit | Access | Default Value | Description |
|---------|--------|---------------------------------------------------|-----------------------------------------------------------------------------------------------------------------------------------------------------------------------------------------------------------------------------------------------------------|
| 255:192 | RO | 000000000000 00000h | Reserved |
| 191:0 | RO | 00000000de4498a3619fa4f4e5e30200613d4a51a6f9e712h | <p>Public Key Hash (TXT.PUBLIC.KEY HASH): This is a field that contains the hash of the chipset's public key.</p> <p>Public Key: 00000000de4498a3619fa4f4e5e30200613d4a51a6f9e712h</p> <p>NOTE: The Public Key is chipset specific,</p> |



11.1.25 TXT.CMD.SECRETS—TXT Secrets Command

The ILP SINIT code does this to tell the chipset that there are going to be secrets in memory. This is used when determining whether to block memory after a reset or power failure.

11.1.26 TXT.CMD.NO-SECRETS—TXT Secrets Command

The CPU that authenticates the SEXIT code does this to tell the chipset that there are no more secrets in memory. It is also used by the Authenticated Code that wipes secrets from memory after a reset.

11.1.27 TXT.E2STS—TXT Extended Error Status Register

B/D/F/Type: 0/0/0/TXT Specific
 Address Offset: 8F0-8F7h
 Default Value: 0000000000000000h
 Access: RO
 Size: 64 bits

This register is used to read the status associated with various errors that might be detected. The bits in this register are only valid if the TXT.WAKE-ERROR.STS bit is set in the TXT.EXTS register. The bits in this register are all sticky. The default value is undefined.

| Bit | Access | Default Value | Description |
|-------|--------|---------------|-------------------------------------------------------------------------------------------------------------------------------------------------------------------------------------------------------------------------------------------------------------------------------------------------------------------------------|
| 63:33 | RO | 0h | Reserved |
| 32 | RO | 0b | TXT Reset Policy (TXT.RESET.POLICY): When cleared to '0', an assertion of the TXTRESET# pin will cause a full system reset, whereby the ICH does a handshake with the MCH before asserting the Platform Reset. When set to '1', the ICH will do a power cycle of the platform on an assertion of TXTRESET#. Default=0. |
| 31:3 | RO | 0b | Reserved |
| 2 | RO | 0b | TXT Memory Block Status (TXT.BLOCK-MEM.STS): This bit indicates if the ICH has indicated to the MCH that it should block memory accesses. Reset only by RTEST#. |
| 1 | RO | 0b | TXT Secrets Status (TXT.SECRETS.STS): This bit indicates if there are any potential secrets in memory. This is used in the setting of the various flags. Reset only by RTEST#. |
| 0 | RO | 0b | TXT Sleep entry error status (TXT.SLP-ENTRY-ERROR.STS): This bit indicates if there has been an improper attempt to go to sleeping state. Reset only by RTEST#. |

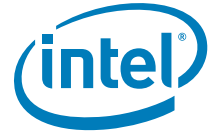

11.2 Intel® TXT Memory Map

Intel TXT introduces a new memory configuration space and requires physical memory be allocated from the physical memory map. The Intel TXT configuration space is located just below the top of the 4 GB addressable space. The Intel TXT device memory is allocated from the top of the physical memory below 4 GB and must be allocated below other chipset memory regions. Both the Intel TXT configuration space and Intel TXT device memory must be reported as unavailable to the operating system.

11.2.1 Intel® TXT Private Space

The Intel TXT private configuration space is decoded beginning at the fixed address FED20000h and is only accessible by the AC modules and MLE. Special TXT.RD and TXT.WT cycles have been defined to access this space. Intel TXT management registers are located in this space and are used by the authenticated code modules and the MLE to launch and maintain the Intel TXT environment. Any attempt by the BIOS to read Intel TXT private space will return invalid data. BIOS must report this region as unavailable to the OS.

11.2.2 Intel® TXT Public Space

The Intel TXT public configuration space is decoded beginning at the fixed address FED30000h. The registers located in the Intel TXT public space can be accessed using standard memory reads and writes. General purpose Intel TXT configuration registers are located in this space and the BIOS must report this region as unavailable to the OS.

11.2.3 TPM Decode Area

The TPM decode area provides access to TPM configuration registers and is decoded beginning at the fixed address FED40000h. This space is divided into multiple 4K pages, also known as localities, with each page controlled by a different set of attributes. The pages may be accessed by Intel TXT cycles only or Intel TXT cycles and Private cycles, or Intel TXT cycles, Private cycles, and Public cycles. See the TPM PC Client specifications for details regarding the TPM configuration space.

§ §

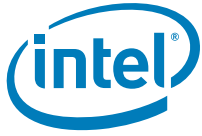



12 Intel® Virtualization Technology for Directed I/O Registers (D0:F0) (Intel® 82Q45 GMCH Only)

12.1 DMI and PEG VC0/VCp Remap Registers

Table 26. Intel® Virtualization Technology For Directed I/O Register Address Map

| Address Offset | Register Symbol | Register Name | Default Value | Access |
|----------------|-----------------|--------------------------------------|----------------------|---------------------|
| 0–3h | VER_REG | Version Register | 00000010h | RO |
| 8–Fh | CAP_REG | Capability Register | 00C908020 630272h | RO |
| 10–17h | ECAP_REG | Extended Capability Register | 0000000000 01000h | RO |
| 18–1Bh | GCMD_REG | Global Command Register | 00000000h | RO, W |
| 1C–1Fh | GSTS_REG | Global Status Register | 00000000h | RO |
| 20–27h | RTADDR_REG | Root-Entry Table Address Register | 0000000000 00000h | R/W, RO |
| 28–2Fh | CCMD_REG | Context Command Register | 0000000000 00000h | W, R/W, RO |
| 34–37h | FSTS_REG | Fault Status Register | 00000000h | RO, RO/P, R/WC/P |
| 38–3Bh | FECTL_REG | Fault Event Control Register | 80000000h | R/W, RO |
| 3C–3Fh | FEDATA_REG | Fault Event Data Register | 00000000h | RO, R/W |
| 40–43h | FEADDR_REG | Fault Event Address Register | 00000000h | RO, R/W |
| 44–47h | FEUADDR_REG | Fault Event Upper Address Register | 00000000h | RO |
| 58–5Fh | AFLOG_REG | Advanced Fault Log Register | 0000000000 00000h | RO |
| 64–67h | PMEN_REG | Protected Memory Enable Register | 00000000h | RO, R/W |
| 68–6Bh | PLMBASE_REG | Protected Low-Memory Base Register | 00000000h | R/W, RO |
| 6C–6Fh | PLMLIMIT_REG | Protected Low-Memory Limit Register | 00000000h | R/W, RO |
| 70–77h | PHMBASE_REG | Protected High-Memory Base Register | 0000000000 00000h | RO, R/W |
| 78–7Fh | PHMLIMIT_REG | Protected High-Memory Limit Register | 0000000000 00000h | R/W, RO |
| 100–107h | IVA_REG | Invalidate Address Register | 0000000000 00000h | W, RO |



12.1.1 VER_REG—Version Register

B/D/F/Type: 0/0/0/VCOPREMAP
 Address Offset: 0-3h
 Default Value: 00000010h
 Access: RO
 Size: 32 bits

This register reports the architecture version supported. Backward compatibility for the architecture is maintained with new revision numbers, allowing software to load DMA-remapping drivers written for prior architecture versions.

| Bit | Access | Default Value | RST/PWR | Description |
|------|--------|-----------------------------------|---------|-----------------------------------------------------------------------------------------------|
| 31:8 | RO | 000000000 000000000 000000b | Core | Reserved |
| 7:4 | RO | 0001b | Core | Major Version number (MAX): This field indicates supported architecture version. |
| 3:0 | RO | 0000b | Core | Minor Version number (MIN): This field indicates supported architecture minor version. |

12.1.2 CAP_REG—Capability Register

B/D/F/Type: 0/0/0/VCOPREMAP
 Address Offset: 8-Fh
 Default Value: 00C9008020630272h
 Access: RO
 Size: 64 bits

This register reports general DMA remapping hardware capabilities.

| Bit | Access | Default Value | RST/PWR | Description |
|-------|--------|---------------|---------|------------------------------------------------------------------------------------------------------------------------------------------------------------------------------------------------------------------------------------------------------------------------------------------------------------------------------------------|
| 63:56 | RO | 00h | Core | Reserved |
| 55 | RO | 1b | Core | DMA Read Draining (DRD): 0 = On IOTLB invalidations, hardware does not support draining of translated DMA read requests queued within the root complex. 1 = On IOTLB invalidations, hardware supports draining of translated DMA read requests queued within the root complex. Indicates supported architecture version. |
| 54 | RO | 1b | Core | DMA Write Draining (DWD): 0 = On IOTLB invalidations, hardware does not support draining of translated DMA writes queued within the root complex. 1 = On IOTLB invalidations, hardware supports draining of translated DMA writes queued within the root complex. |
| 53:48 | RO | 001001b | Core | Maximum Address Mask Value (MAMV): The value in this field indicates the maximum supported value for the Address Mask (AM) field in the Invalidation Address (IVA_REG) register. |



| Bit | Access | Default Value | RST/PWR | Description |
|-------|--------|---------------|---------|----------------------------------------------------------------------------------------------------------------------------------------------------------------------------------------------------------------------------------------------------------------------------------------------------------------------------------------------------------------------------------------------------------------------------------------------------------------------------------------------------------------|
| 47:40 | RO | 00000000b | Core | <p>Number of Faultrecording Registers (NFR): This field indicates a value of N-1, where N is the number of fault recording registers supported by hardware.</p> <p>Implementations must support at least one fault recording register (NFR = 0) for each DMAremapping hardware unit in the platform.</p> <p>The maximum number of fault recording registers per DMA-remapping hardware unit is 256.</p> <p>Bit 40 in the capability register is the least significant bit of the NFR field (47:40).</p> |
| 39 | RO | 1b | Core | <p>Page Selective Invalidation Support (PSI):</p> <p>0 = DMAr engine does not support page selective invalidations</p> <p>1 = DMAr engine does support page-selective IOTLB invalidations. The MAMV field indicates the maximum number of contiguous translations that may be invalidated in a single request.</p> |
| 38 | RO | 0b | Core | Reserved |
| 37:34 | RO | 0000b | Core | <p>Super Page Support (SPS): This field indicates the super page sizes supported by hardware. A value of 1 in any of these bits indicates the corresponding super-page size is supported. The super-page sizes corresponding to various bit positions within this field are:</p> <p>0 = 21-bit offset to page frame</p> <p>1 = 30-bit offset to page frame</p> <p>2 = 39-bit offset to page frame</p> <p>3 = 48-bit offset to page frame</p> |
| 33:24 | RO | 020h | Core | <p>Fault-recording Register offset (FRO): This field specifies the location to the first fault recording register relative to the register base address of this DMA-remapping hardware unit. If the register base address is X, and the value reported in this field is Y, the address for the first fault recording register is calculated as $X + (16 * Y)$.</p> |
| 23 | RO | 0b | Core | <p>Isochrony (Isoch):</p> <p>0 = DMA-remapping hardware unit has no critical isochronous requesters in its scope.</p> <p>1 = DMA-remapping hardware unit has one or more critical isochronous requesters in its scope.</p> <p>To ensure isochronous performance, software must ensure invalidation operations do not impact active DMA streams. This implies that when DMA is active, software perform page-selective invalidations (instead of coarser invalidations).</p> |
| 22 | RO | 1b | Core | <p>Zero Length Read (ZLR):</p> <p>0 = Remapping hardware unit blocks (and treats as fault) zero length DMA read requests to write-only pages.</p> <p>1 = Remapping hardware unit supports zero length DMA read requests to write-only pages.</p> |



| Bit | Access | Default Value | RST/PWR | Description |
|-------|--------|---------------|---------|---------------------------------------------------------------------------------------------------------------------------------------------------------------------------------------------------------------------------------------------------------------------------------------------------------------------------------------------------------------------------------------------------------------------------------------------------------------------------------------------------------------------------------------------------------------------------------------------------------------------------------------------------------------------------------------------------------------------------------------------------------------------------------------------------------------------------------------------------------------------------------------------------------------|
| 21:16 | RO | 100011b | Core | <p>Maximum Guest Address Width (MGAW): This field indicates the maximum DMA virtual addressability supported by remapping hardware.</p> <p>The Maximum Guest Address Width (MGAW) is computed as $(N+1)$, where N is the value reported in this field. For example, a hardware implementation supporting 48-bit MGAW reports a value of 47 (101111b) in this field.</p> <p>If the value in this field is X, DMA requests to addresses above $2(x+1)-1$ are always blocked by hardware.</p> <p>Guest addressability for a given DMA request is limited to the minimum of the value reported through this field and the adjusted guest address width of the corresponding page-table structure. (Adjusted guest address widths supported by hardware are reported through the SAGAW field).</p> |
| 15:13 | RO | 000b | Core | Reserved |
| 12:8 | RO | 00010b | Core | <p>Supported Adjusted Guest Address Widths (SAGAW): This 5-bit field indicates the supported adjusted guest address widths (which in turn represents the levels of page-table walks) supported by the hardware implementation.</p> <p>A value of 1 in any of these bits indicates the corresponding adjusted guest address width is supported. The adjusted guest address widths corresponding to various bit positions within this field are:</p> <ul style="list-style-type: none"> 0 = 30-bit AGAW (2-level page table) 1 = 39-bit AGAW (3-level page table) 2 = 48-bit AGAW (4-level page table) 3 = 57-bit AGAW (5-level page table) 4 = 64-bit AGAW (6-level page table) <p>Software must ensure that the adjusted guest address width used to setup the page tables is one of the supported guest address widths reported in this field.</p> |
| 7 | RO | 0b | Core | <p>Caching Mode (CM):</p> <ul style="list-style-type: none"> 0 = Hardware does not cache not present and erroneous entries in the context-cache and IOTLB. Invalidation are not required for modifications to individual not present or invalid entries. However, any modifications that result in decreasing the effective permissions or partial permission increases require invalidations for them to be effective. 1 = Hardware may cache not present and erroneous mappings in the context-cache or IOTLB. Any software updates to the DMA-remapping structures (including updates to not-present or erroneous entries) require explicit invalidation. <p>Hardware implementations are recommended to support operation corresponding to CM=0.</p> |



| Bit | Access | Default Value | RST/PWR | Description |
|-----|--------|---------------|---------|-----------------------------------------------------------------------------------------------------------------------------------------------------------------------------------------------------------------------------------------------------------------------------------------------------------------------------------------------------------------------------------------------------------------------------------------------------------------------------------------------------------------------------------------------------------------------------------------------------------------------------------------------------|
| 6 | RO | 1b | Core | Protected High-Memory Region (PHMR): 0 = Indicates protected high-memory region not supported. 1 = Indicates protected high-memory region is supported. DMA-remapping hardware implementations on Intel TXT platforms supporting main memory above 4 GB are required to support protected high-memory region. |
| 5 | RO | 1b | Core | Protected Low-Memory Region (PLMR): 0 = Indicates protected low-memory region not supported. 1 = Indicates protected low-memory region is supported. DMA-remapping hardware implementations on Intel TXT platforms are required to support protected low-memory region. |
| 4 | RO | 1b | Core | Required Write-Buffer Flushing (RWBF): 0 = Indicates no write-buffer flushing needed to ensure changes to memory-resident structures are visible to hardware. 1 = Indicates software must explicitly flush the write buffers (through the Global Command register) to ensure updates made to memory-resident DMA-remapping structures are visible to hardware. |
| 3 | RO | 0b | Core | Advanced Fault Logging (AFL): 0 = Indicates advanced fault logging not supported. Only primary fault logging is supported. 1 = Indicates advanced fault logging is supported. |
| 2:0 | RO | 010b | Core | Number of domains supported (ND): 000 = Hardware supports 4-bit domain-IDs with support for up to 16 domains. 001 = Hardware supports 6-bit domain-IDs with support for up to 64 domains. 010 = Hardware supports 8-bit domain-IDs with support for up to 256 domains. 011 = Hardware supports 10-bit domain-IDs with support for up to 1024 domains. 100 = Hardware supports 12-bit domain-IDs with support for up to 4 KB domains. 100 = Hardware supports 14-bit domain-IDs with support for up to 16 KB domains. 110 = Hardware supports 16-bit domain-IDs with support for up to 64 KB domains. 111 = Reserved. |



12.1.3 ECAP_REG—Extended Capability Register

B/D/F/Type: 0/0/0/VCOPREMAP
 Address Offset: 10-17h
 Default Value: 0000000000001000h
 Access: RO
 Size: 64 bits

This register reports DMA-remapping hardware extended capabilities

| Bit | Access | Default Value | RST/PWR | Description |
|-------|--------|---------------|---------|---------------------------------------------------------------------------------------------------------------------------------------------------------------------------------------------------------------------------------------------------------------------------------------------------------------------------------------------------------------------------------------------------------------------------------------------------------------------------------------|
| 63:24 | RO | 0s | Core | Reserved |
| 23:20 | RO | 0000b | Core | Maximum Handle Mask Value (MHMV): The value in this field indicates the maximum supported value for the Handle Mask (HM) field in the interrupt entry cache invalidation descriptor (<i>iec_inv_dsc</i>). This field is valid only when the IR field is reported as Set. |
| 19:18 | RO | 00b | Core | Reserved |
| 17:8 | RO | 010h | Core | Invalidation Unit Offset (IVO): This field specifies the location to the first IOTLB invalidation unit relative to the register base address of this DMA-remapping hardware unit. If the register base address is X, and the value reported in this field is Y, the address for the first IOTLB invalidation unit is calculated as X+(16*Y). If N is the value reported in NIU field, the address for the last IOTLB invalidation unit is calculated as X+(16*Y)+(16*N). |
| 7 | RO | 0b | Core | Snoop Control (SC): 0 = Hardware does not support 1-setting of the SNP field in the page-table entries. 1 = Hardware supports the 1-setting of the SNP field in the page-table entries. |
| 6 | RO | 0b | Core | Pass Through (PT): 0 = Hardware does not support passthrough translation type in context entries. 1 = Hardware supports pass-through translation type in context entries. |
| 5 | RO | 0b | Core | Caching Hints (CH): 0 = Hardware does not support IOTLB caching hints (ALH and EH fields in context-entries are treated as reserved). 1 = Hardware supports IOTLB caching hints through the ALH and EH fields in context-entries. |
| 4 | RO | 0b | Core | Extended Interrupt Mode (EIM): 0 = Hardware supports only 8-bit APICIDs (Legacy Interrupt Mode) on Intel® 64 and IA-32 platforms and 16-bit APIC-IDs on Itanium™ platforms. 1 = Hardware supports Extended Interrupt Mode (32-bit APIC-IDs) on Intel® 64 platforms. This field is valid only when the IR field is reported as Set. |



| Bit | Access | Default Value | RST/PWR | Description |
|-----|--------|---------------|---------|-----------------------------------------------------------------------------------------------------------------------------------------------------------------------------------------------------------------------------------------------------------------------------------------------------|
| 3 | RO | 0b | Core | Interrupt Remapping Support (IR): 0 = Hardware does not support interrupt remapping. 1 = Hardware supports interrupt remapping. Implementations reporting this field as Set must also support Queued Invalidation (QI = 1b). |
| 2 | RO | 0b | Core | Device IOTLB Support (DI): 0 = • 0: Hardware does not support device- IOTLBs. 1 = • 1: Hardware supports Device-IOTLBs. Implementations reporting this field as Set must also support Queued Invalidation (QI = 1b). |
| 1 | RO | 0b | Core | Queued Invalidation Support (QI): 0 = Hardware does not support queued invalidations. 1 = Hardware supports queued invalidations. |
| 0 | RO | 0b | Core | Coherency (C): 0 = Hardware accesses to the root, context, and page table structures are non-coherent (non-snoop) 1 = Hardware accesses to the root, context, and page table structures are coherent (snoop). Hardware writes to the advanced fault log is required to be coherent. |



12.1.4 GCMD_REG—Global Command Register

B/D/F/Type: 0/0/0/VCOPREMAP
 Address Offset: 18-1Bh
 Default Value: 00000000h
 Access: RO, W
 Size: 32 bits

This register controls DMA-remapping hardware. If multiple control fields in this register need to be modified, software must serialize through multiple writes to this register.

| Bit | Access | Default Value | RST/PWR | Description |
|-----|--------|---------------|---------|-----------------------------------------------------------------------------------------------------------------------------------------------------------------------------------------------------------------------------------------------------------------------------------------------------------------------------------------------------------------------------------------------------------------------------------------------------------------------------------------------------------------------------------------------------------------------------------------------------------------------------------------------------------------------------------------------------------------------------------------------------------------------------------------------------------------------------------------------------------------------------------------------------------------------------------------------------------------------------------------------------------------------------------------------------------------------------------------------------------------------------------------------------------------------------------------------------------------------------------------------------------------------------------------------------------------------------------------------------------------------------------------------------------------------------------------------------------------------------------------------------------------------------------------------------------------------------------------------------------------------------|
| 31 | W | 0b | Core | <p>Translation Enable (TE): Software writes to this field to request hardware to enable/disable DMA-remapping hardware.</p> <p>0 = Disable DMA-remapping hardware 1 = Enable DMA-remapping hardware</p> <p>Hardware reports the status of the translation enable operation through the TES field in the Global Status register.</p> <p>Before enabling (or re-enabling) DMA-remapping hardware through this field, software must:</p> <ul style="list-style-type: none"> • Setup the DMA-remapping structures in memory • Flush the write buffers (through WBF field), if write buffer flushing is reported as required. • Set the root-entry table pointer in hardware (through SRTP field). • Perform global invalidation of the context-cache and global invalidation of IOTLB • If advanced fault logging supported, setup fault log pointer (through SFL field) and enable advanced fault logging (through EAFL field). <p>There may be active DMA requests in the platform when software updates this field. Hardware must enable or disable remapping logic only at deterministic transaction boundaries, so that any in-flight transaction is either subject to remapping or not at all.</p> <p>Hardware implementations supporting DMA draining must drain any in-flight translated DMA read/write requests queued within the root complex before completing the translation enable command and reflecting the status of the command through the TES field in the GSTS_REG.</p> <p>Value returned on read of this field is undefined.</p> |

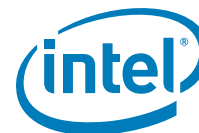

| Bit | Access | Default Value | RST/PWR | Description |
|-----|--------|---------------|---------|------------------------------------------------------------------------------------------------------------------------------------------------------------------------------------------------------------------------------------------------------------------------------------------------------------------------------------------------------------------------------------------------------------------------------------------------------------------------------------------------------------------------------------------------------------------------------------------------------------------------------------------------------------------------------------------------------------------------------------------------------------------------------------------------------------------------------------------------------------------------------------------------------------------------------------------------------------------------------------------------------------------------------------------------------------------------------------------------------------------------------------------------------------------------------------------------------------------------------------------------------------------------------------------------------|
| 30 | W | 0b | Core | <p>Set Root Table Pointer (SRTP): Software sets this field to set/update the root-entry table pointer used by hardware. The root-entry table pointer is specified through the Root-entry Table Address register.</p> <p>Hardware reports the status of the root table pointer set operation through the RTPS field in the Global Status register.</p> <p>The root table pointer set operation must be performed before enabling or re-enabling (after disabling) DMA-remapping hardware.</p> <p>After a root table pointer set operation, software must globally invalidate the context cache followed by global invalidate of IOTLB. This is required to ensure hardware uses only the remapping structures referenced by the new root table pointer, and not any stale cached entries.</p> <p>While DMA-remapping hardware is active, software may update the root table pointer through this field. However, to ensure valid in-flight DMA requests are deterministically remapped, software must ensure that the structures referenced by the new root table pointer are programmed to provide the same remapping results as the structures referenced by the previous root table pointer.</p> <p>Clearing this bit has no effect. Value returned on read of this field is undefined.</p> |
| 29 | RO | 0b | Core | <p>Set Fault Log (SFL): This field is valid only for implementations supporting advanced fault logging. If advanced fault logging is not supported, writes to this field are ignored.</p> <p>Software sets this field to request hardware to set/update the fault-log pointer used by hardware. The fault-log pointer is specified through Advanced Fault Log register.</p> <p>Hardware reports the status of the fault log set operation through the FLS field in the Global Status register.</p> <p>The fault log pointer must be set before enabling advanced fault logging (through EAFL field). Once advanced fault logging is enabled, the fault log pointer may be updated through this field while DMA-remapping hardware is active.</p> <p>Clearing this bit has no effect. Value returned on read of this field is undefined.</p> <p>NOTE: This field is reserved as this feature is not supported.</p> |



| Bit | Access | Default Value | RST/PWR | Description |
|-----|--------|---------------|---------|-------------------------------------------------------------------------------------------------------------------------------------------------------------------------------------------------------------------------------------------------------------------------------------------------------------------------------------------------------------------------------------------------------------------------------------------------------------------------------------------------------------------------------------------------------------------------------------------------------------------------------------------------------------------------------------------------------------------------------------------------------------------------------------------------------------------------------------------------------------------------------------------------------------------------------------------------------------------------|
| 28 | RO | 0b | Core | <p>Enable Advanced Fault Logging (EAFL): This field is valid only for implementations supporting advanced fault logging. If advanced fault logging is not supported, writes to this field are ignored. Software writes to this field to request hardware to enable or disable advanced fault logging.</p> <p>0 = Disable advanced fault logging. In this case, translation faults are reported through the Fault Recording registers.</p> <p>1 = Enable use of memory-resident fault log. When enabled, translation faults are recorded in the memory-resident log. The fault log pointer must be set in hardware (through SFL field) before enabling advanced fault logging.</p> <p>Hardware reports the status of the advanced fault logging enable operation through the AFLS field in the Global Status register.</p> <p>Value returned on read of this field is undefined.</p> <p>NOTE: This field is reserved as this feature is not supported.</p> |
| 27 | W | 0b | Core | <p>Write Buffer Flush (WBF): This bit is valid only for implementations requiring write buffer flushing. If write buffer flushing is not required, writes to this field are ignored.</p> <p>Software sets this field to request hardware to flush the root-complex internal write buffers. This is done to ensure any updates to the memory-resident DMA-remapping structures are not held in any internal write posting buffers. Refer to Section 9.1 for details on write-buffer flushing requirements.</p> <p>Hardware reports the status of the write buffer flushing operation through the WBFS field in the Global Status register.</p> <p>Clearing this bit has no effect. Value returned on read of this field is undefined.</p> |
| 26 | RO | 0b | Core | <p>Queued Invalidation Enable (QIE): This field is valid only for implementations supporting queued invalidations. Software writes to this field to enable or disable queued invalidations.</p> <p>0 = Disable queued invalidations.</p> <p>1 = Enable use of queued invalidations.</p> <p>Hardware reports the status of queued invalidation enable operation through QIES field in the Global Status register. The value returned on a read of this field is undefined.</p> <p>NOTE: This field is reserved as this feature is not supported.</p> |

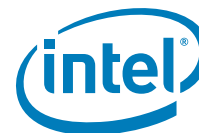

| Bit | Access | Default Value | RST/PWR | Description |
|-----|--------|---------------|---------|-----------------------------------------------------------------------------------------------------------------------------------------------------------------------------------------------------------------------------------------------------------------------------------------------------------------------------------------------------------------------------------------------------------------------------------------------------------------------------------------------------------------------------------------------------------------------------------------------------------------------------------------------------------------------------------------------------------------------------------------------------------------------------------------------------------------------------------------------------------------------------------------------------------------------------------------------------------------------------------------------------------------------------------------------------------------------------------------------------------------------------------------------------------------------------------------------------------------------------------------------------------------------------------------------------------------------------------------------------------------------------------------------------------------------------------------------------------------------------------------------------------------------------------------------------------------------------------------------------------------------------------------------------------------------------------------------------|
| 25 | RO | 0b | Core | <p>Interrupt Remapping Enable (IRE): This field is valid only for implementations supporting interrupt remapping. 0 = Disable interrupt-remapping hardware 1 = Enable interrupt-remapping hardware Hardware reports the status of the interrupt remapping enable operation through the IRES field in the Global Status register. There may be active interrupt requests in the platform when software updates this field. Hardware must enable or disable interrupt-remapping logic only at deterministic transaction boundaries, so that any in-flight interrupts are either subject to remapping or not at all. Hardware implementations must drain any in-flight interrupts requests queued in the Root-Complex before completing the interrupt-remapping enable command and reflecting the status of the command through the IRES field in the Global Status register. The value returned on a read of this field is undefined.</p> <p>NOTE: This field is reserved as this feature is not supported.</p> |
| 24 | RO | 0b | Core | <p>Set Interrupt Remap Table Pointer (SIRTP): This field is valid only for implementations supporting interrupt-remapping. Software sets this field to set/update the interrupt remapping table pointer used by hardware. The interrupt remapping table pointer is specified through the Interrupt Remapping Table Address register. Hardware reports the status of the interrupt remapping table pointer set operation through the IRTPS field in the Global Status register. The interrupt remap table pointer set operation must be performed before enabling or re-enabling (after disabling) interrupt-remapping hardware through the IRE field. After an interrupt remap table pointer set operation, software must globally invalidate the interrupt entry cache. This is required to ensure hardware uses only the interrupt-remapping entries referenced by the new interrupt remap table pointer, and not any stale cached entries. While interrupt remapping is active, software may update the interrupt remapping table pointer through this field. However, to ensure valid in-flight interrupt requests are deterministically remapped, software must ensure that the structures referenced by the new interrupt remap table pointer are programmed to provide the same remapping results as the structures referenced by the previous interrupt remap table pointer. Clearing this bit has no effect. The value returned on a read of this field is undefined.</p> <p>NOTE: This field is reserved as this feature is not supported.</p> |



| Bit | Access | Default Value | RST/PWR | Description |
|------|--------|---------------|---------|------------------------------------------------------------------------------------------------------------------------------------------------------------------------------------------------------------------------------------------------------------------------------------------------------------------------------------------------------------------------------------------------------------------------------------------------------------------------------------------------------------------------------------------------------------------------------------------------------------------------------------------------------------------------------------------------------------------------------------------------------------------------------------------------------------------------------------------------------------------|
| 23 | RO | 0b | Core | <p>Compatibility Format Interrupt (CFI): This field is valid only for Intel 64 implementations supporting interrupt-remapping. Software writes to this field to enable or disable Compatibility Format interrupts on Intel 64 platforms. The value in this field is effective only when interrupt-remapping is enabled and Legacy Interrupt Mode is active.</p> <p>0 = Block Compatibility format interrupts. 1 = Process Compatibility format interrupts as pass-through (bypass interrupt remapping).</p> <p>Hardware reports the status of updating this field through the CFIS field in the Global Status register.</p> <p>The value returned on a read of this field is undefined.</p> <p>This field is not implemented on Itanium™ implementations.</p> <p>NOTE: This field is reserved as this feature is not supported.</p> |
| 22:0 | RO | 000000h | Core | Reserved |



12.1.5 GSTS_REG—Global Status Register

B/D/F/Type: 0/0/0/VCOPREMAP
 Address Offset: 1C-1Fh
 Default Value: 00000000h
 Access: RO
 Size: 32 bits

This register reports general DMA-remapping hardware status.

| Bit | Access | Default Value | RST/PWR | Description |
|-----|--------|---------------|---------|------------------------------------------------------------------------------------------------------------------------------------------------------------------------------------------------------------------------------------------------------------------------------------------------------------------------------------------------------------------------------------------------------------------------------------------------------|
| 31 | RO | 0b | Core | Translation Enable Status (TES): This field indicates the status of DMA-remapping hardware. 0 = DMA-remapping hardware is not enabled 1 = DMA-remapping hardware is enabled |
| 30 | RO | 0b | Core | Root Table Pointer Status (RTPS): This field indicates the status of the root- table pointer in hardware. This field is cleared by hardware when software sets the SRTP field in the Global Command register. This field is set by hardware when hardware completes the set root-table pointer operation using the value provided in the Root-Entry Table Address register. |
| 29 | RO | 0b | Core | Fault Log Status (FLS): This field is valid only for implementations supporting advanced fault logging. This field indicates the status of the fault-log pointer in hardware. This field is cleared by hardware when software sets the SFL field in the Global Command register. This field is set by hardware when hardware completes the set fault-log pointer operation using the value provided in the Advanced Fault Log register. |
| 28 | RO | 0b | Core | Advanced Fault Logging Status (AFLS): This field is valid only for implementations supporting advanced fault logging. This field indicates advanced fault logging status. 0 = Advanced Fault Logging is not enabled 1 = Advanced Fault Logging is enabled |
| 27 | RO | 0b | Core | Write Buffer Flush Status (WBFS): This bit is valid only for implementations requiring write buffer flushing. This field indicates the status of the write buffer flush operation. This field is set by hardware when software sets the WBF field in the Global Command register. This field is cleared by hardware when hardware completes the write buffer flushing operation. |
| 26 | RO | 0b | Core | Queued Invalidation Enable Status (QIES): This field indicates queued invalidation enable status. 0 = queued invalidation is not enabled 1 = queued invalidation is enabled |
| 25 | RO | 0b | Core | Interrupt Remapping Enable Status (IRES): This field indicates the status of Interrupt-remapping hardware. 0 = Interrupt-remapping hardware is not enabled 1 = Interrupt-remapping hardware is enabled |



| Bit | Access | Default Value | RST/PWR | Description |
|------|--------|---------------|---------|----------------------------------------------------------------------------------------------------------------------------------------------------------------------------------------------------------------------------------------------------------------------------------------------------------------------------------------------------------------------------------------------------------------------------------------------------------------------------|
| 24 | RO | 0b | Core | Interrupt Remapping Table Pointer Status (IRTPS): This field indicates the status of the interrupt remapping table pointer in hardware. This field is cleared by hardware when software sets the SIRTTP field in the Global Command register. This field is Set by hardware when hardware completes the set interrupt remap table pointer operation using the value provided in the Interrupt Remapping Table Address register. |
| 23 | RO | 0b | Core | Compatibility Format Interrupt Status (CFIS): This field indicates the status of Compatibility format interrupts on Intel 64 implementations supporting interrupt-remapping. The value reported in this field is applicable only when interrupt-remapping is enabled and Legacy interrupt mode is active. 0 = Compatibility format interrupts are blocked. 1 = Compatibility format interrupts are processed as pass-through (bypassing interrupt remapping). |
| 22:0 | RO | 000000h | Core | Reserved |

12.1.6 RTADDR_REG—Root-Entry Table Address Register

B/D/F/Type: 0/0/0/VCOPREMAP
 Address Offset: 20-27h
 Default Value: 0000000000000000h
 Access: R/W, RO
 Size: 64 bits

This register provides the base address of root-entry table.

| Bit | Access | Default Value | RST/PWR | Description |
|-------|--------|--------------------|---------|------------------------------------------------------------------------------------------------------------------------------------------------------------------------------------------------------------------------------------------------------------------------------------------------------------------------------------------------------------------------------------------------------------------------------------------------------------------------|
| 63:12 | R/W | 000000000 0000h | Core | Root table address (RTA): This register points to base of page aligned, 4 KB-sized root-entry table in system memory. Hardware may ignore and not implement bits 63:HAW, where HAW is the host address width. Software specifies the base address of the root-entry table through this register, and programs it in hardware through the SRTTP field in the Global Command register. Reads of this register returns value that was last programmed to it. |
| 11:0 | RO | 000h | Core | Reserved |



12.1.7 CCMD_REG—Context Command Register

B/D/F/Type: 0/0/0/VCOPREMAP
 Address Offset: 28-2Fh
 Default Value: 0000000000000000h
 Access: W, R/W, RO
 Size: 64 bits

Register to manage context cache. The act of writing the uppermost byte of the CCMD_REG with ICC field set causes the hardware to perform the context-cache invalidation.

| Bit | Access | Default Value | RST/PWR | Description |
|-----|--------|---------------|---------|-------------------------------------------------------------------------------------------------------------------------------------------------------------------------------------------------------------------------------------------------------------------------------------------------------------------------------------------------------------------------------------------------------------------------------------------------------------------------------------------------------------------------------------------------------------------------------------------------------------------------------------------------------------------------------------------------------------------------------------------------------------------------------------------------------------------------------------------------------------------------------------------------------------------------------------------------------------------------------------------------------------------------------------------------------------------------------------------------------------------------------------------------------------------------------------------------------------------------------------------------------------------------------------------------------------------------------------------------------------------------------------------------------------------------------------------------------------------------------------|
| 63 | R/W | 0h | Core | <p>Invalidate Context-Cache (ICC): Software requests invalidation of context-cache by setting this field. Software must also set the requested invalidation granularity by programming the CIRG field.</p> <p>Software must read back and check the ICC field to be clear to confirm the invalidation is complete. Software must not update this register when this field is set.</p> <p>Hardware clears the ICC field to indicate the invalidation request is complete. Hardware also indicates the granularity at which the invalidation operation was performed through the CAIG field. Software must not submit another invalidation request through this register while the ICC field is set.</p> <p>Software must submit a context cache invalidation request through this field only when there are no invalidation requests pending at this DMA-remapping hardware unit. Refer to Section 9 for software programming requirements.</p> <p>Since information from the context-cache may be used by hardware to tag IOTLB entries, software must perform domain-selective (or global) invalidation of IOTLB after the context cache invalidation has completed.</p> <p>Hardware implementations reporting write-buffer flushing requirement (RWBF=1 in Capability register) must implicitly perform a write buffer flushing before reporting invalidation complete to software through the ICC field. Refer to Section 9.1 for write buffer flushing requirements.</p> |



| Bit | Access | Default Value | RST/PWR | Description |
|-------|--------|---------------|---------|-----------------------------------------------------------------------------------------------------------------------------------------------------------------------------------------------------------------------------------------------------------------------------------------------------------------------------------------------------------------------------------------------------------------------------------------------------------------------------------------------------------------------------------------------------------------------------------------------------------------------------------------------------------------------------------------------------------------------------------------------------------------------------------------------------------------------------------------------------------------------------------------------------------------------------------------------------------------------------------------------------------|
| 62:61 | R/W | 0h | Core | <p>Context Invalidation Request Granularity (CIRG): Software provides the requested invalidation granularity through this field when setting the ICC field.</p> <p>00 = Reserved. 01 = Global Invalidation request. 10 = Domain-selective invalidation request. The target domain-ID must be specified in the DID field. 11 = Device-selective invalidation request.</p> <p>The target source-ID(s) must be specified through the SID and FM fields, and the domain-ID (that was programmed in the context-entry for these device(s)) must be provided in the DID field.</p> <p>Hardware implementations may process an invalidation request by performing invalidation at a coarser granularity than requested. Hardware indicates completion of the invalidation request by clearing the ICC field. At this time, hardware also indicates the granularity at which the actual invalidation was performed through the CAIG field.</p> |
| 60:59 | RO | 0h | Core | <p>Context Actual Invalidation Granularity (CAIG): Hardware reports the granularity at which an invalidation request was processed through the CAIG field at the time of reporting invalidation completion (by clearing the ICC field).</p> <p>00 =Reserved. 01 = Global Invalidation performed. This could be in response to a global, domain-selective or device-selective invalidation request. 10 = Domain-selective invalidation performed using the domain-ID specified by software in the DID field. This could be in response to a domain-selective or device-selective invalidation request. 11 = Device-selective invalidation performed using the source-ID and domain-ID specified by software in the SID and FM fields. This can only be in response to a device-selective invalidation request.</p> |
| 58:34 | RO | 00000000h | Core | Reserved |



| Bit | Access | Default Value | RST/PWR | Description |
|-------|--------|---------------|---------|--------------------------------------------------------------------------------------------------------------------------------------------------------------------------------------------------------------------------------------------------------------------------------------------------------------------------------------------------------------------------------------------------------------------------------------------------------------------------------------------------------------------------------------------------------------------------------------------------------------------------------------------------------------------------|
| 33:32 | W | 0h | Core | <p>Function Mask (FM): This field specifies which bits of the function number portion (least significant three bits) of the SID field to mask when performing device-selective invalidations.</p> <p>00 = No bits in the SID field masked.</p> <p>01 = Mask most significant bit of function number in the SID field.</p> <p>10 = Mask two most significant bit of function number in the SID field.</p> <p>11 = Mask all three bits of function number in the SID field.</p> <p>The device(s) specified through the FM and SID fields must correspond to the domain-ID specified in the DID field.</p> <p>Value returned on read of this field is undefined.</p> |
| 31:16 | W | 0000h | Core | <p>Source ID (SID): This field indicates the source-ID of the device whose corresponding context-entry needs to be selectively invalidated. This field along with the FM field must be programmed by software for device-selective invalidation requests.</p> <p>Value returned on read of this field is undefined.</p> |
| 15:0 | R/W | 0000h | Core | <p>Domain-ID (DID): This field indicates the ID of the domain whose context-entries needs to be selectively invalidated. This field must be programmed by software for both domain-selective and device-selective invalidation requests.</p> <p>The Capability register reports the domain-ID width supported by hardware. Software must ensure that the value written to this field is within this limit.</p> <p>Hardware may ignore and not implement bits 15:N where N is the supported domain-ID width reported in the capability register.</p> |

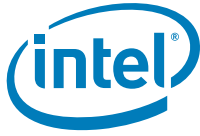

12.1.8 FSTS_REG—Fault Status Register

B/D/F/Type: 0/0/0/VCOPREMAP
 Address Offset: 34-37h
 Default Value: 00000000h
 Access: RO, RO/P, R/WC/P
 Size: 32 bits

This register indicates the primary fault logging status. Section 8.4.18.1 describes hardware behavior for primary fault logging.

| Bit | Access | Default Value | RST/PWR | Description |
|-------|--------|---------------|---------|-----------------------------------------------------------------------------------------------------------------------------------------------------------------------------------------------------------------------------------------------------------------------------------------------------------------------------------------------------------------------------------------------------------------------------------------------------------------------------------------------------------------------------------|
| 31:16 | RO | 0000h | Core | Reserved |
| 15:8 | RO/P | 00h | Core | <p>Fault Record Index (FRI): This field is valid only when the PPF field is set. The FRI field indicates the index (from base) of the fault recording register to which the first pending fault was recorded when the PPF field was set by hardware. Valid values for this field are from 0 to N, where N is the value reported through NFR field in the Capability register.</p> <p>The value read from this field is undefined when the PPF field is clear.</p> |
| 7 | RO | 0b | Core | Reserved |
| 6 | RO | 0b | Core | <p>Invalidation Time-out Error (ITE): Hardware detected a Device-IOTLB invalidation completion time-out. At this time, a fault event may be generated based on the programming of the Fault Event Control register.</p> <p>Hardware implementations not supporting Device-IOTLBs implement this bit as Reserved.</p> <p>NOTE: This field is reserved as this feature is not supported.</p> |
| 5 | RO | 0b | Core | <p>Invalidation Completion Error (ICE): Hardware received an unexpected or invalid Device-IOTLB invalidation completion. This could be due to either an invalid ITag or invalid source-ID in an invalidation completion response. At this time, a fault event may be generated based on the programming of the Fault Event Control register.</p> <p>Hardware implementations not supporting Device-IOTLBs implement this bit as Reserved.</p> <p>NOTE: This field is reserved as this feature is not supported.</p> |



| Bit | Access | Default Value | RST/PWR | Description |
|-----|--------|---------------|---------|------------------------------------------------------------------------------------------------------------------------------------------------------------------------------------------------------------------------------------------------------------------------------------------------------------------------------------------------------------------------------------------------------------------------------------------------------------------------------------------------------------------------------------------------------------------------------------------------------------------------------------------------------------|
| 4 | RO | 0b | Core | <p>Invalidation Queue Error (IQE): Hardware detected an error associated with the invalidation queue. This could be due to either a hardware error while fetching a descriptor from the invalidation queue, or hardware detecting an erroneous or invalid descriptor in the invalidation queue. At this time, a fault event may be generated based on the programming of the Fault Event Control register. Hardware implementations not supporting queued invalidations implement this bit as Reserved.</p> <p>NOTE: This field is reserved as this feature is not supported.</p> |
| 3 | RO | 0b | Core | <p>Advanced Pending Fault (APF): When this field is Clear, hardware sets this field when the first fault record (at index 0) is written to a fault log. At this time, a fault event is generated based on the programming of the Fault Event Control register. Software writing 1 to this field clears it. Hardware implementations not supporting advanced fault logging implement this bit as Reserved.</p> <p>NOTE: This field is reserved as this feature is not supported.</p> |
| 2 | RO | 0b | Core | <p>Advanced Fault Overflow (AFO): Hardware sets this field to indicate advanced fault log overflow condition. At this time, a fault event is generated based on the programming of the Fault Event Control register. Software writing 1 to this field clears it. Hardware implementations not supporting advanced fault logging implement this bit as Reserved.</p> <p>NOTE: This field is reserved as this feature is not supported.</p> |
| 1 | RO/P | 0h | Core | <p>Primary Pending Fault (PPF): This field indicates if there are one or more pending faults logged in the fault recording registers. Hardware computes this field as the logical OR of Fault (F) fields across all the fault recording registers of this DMA-remapping hardware unit.</p> <p>0 = No pending faults in any of the fault recording registers.</p> <p>1 = One or more fault recording registers has pending faults. The FRI field is updated by hardware whenever the PPF field is set by hardware. Also, depending on the programming of Fault Event Control register, a fault event is generated when hardware sets this field.</p> |
| 0 | R/WC/P | 0h | Core | <p>Primary Fault Overflow (PFO): Hardware sets this field to indicate overflow of fault recording registers. Software writing 1 clears this field.</p> |



12.1.9 FECTL_REG—Fault Event Control Register

B/D/F/Type: 0/0/0/VCOPREMAP
 Address Offset: 38-3Bh
 Default Value: 80000000h
 Access: R/W, RO
 Size: 32 bits

This register specifies the fault event interrupt message control bits.

| Bit | Access | Default Value | RST/PWR | Description |
|------|--------|---------------|---------|----------------------------------------------------------------------------------------------------------------------------------------------------------------------------------------------------------------------------------------------------------------------------------------------------------------------------------------------------------------------------------------------------------------------------------------------------------------------------------------------------------------------------------------------------------------------------------------------------------------------------------------------------------------------------------------------------------------------------------------------------------------------------------------------------------------------------------------------------------------------------------------------------------------------------------------------------------------------------------------------------------------------------------------------------------------------------------------------------------------------------------------------------------------------------------------------------------------------------------------------------------------------------------------------------------------------------------------------------------------------------------------------------------------------------------------------------------------------------------------------------------------------------------------------------------------------------------------------------------------------------------------------------------------------------------------------------------------------------------------------------------------------------------------------------------------------------------------------------------------------------------------------------------------------------------------------------------------------------------------------------|
| 31 | R/W | 1h | Core | <p>Interrupt Mask (IM):</p> <p>0 = No masking of interrupt. When an interrupt condition is detected, hardware issues an interrupt message (using the Fault Event Data and Fault Event Address register values).</p> <p>1 = This is the value on reset. Software may mask interrupt message generation by setting this field. Hardware is prohibited from sending the interrupt message when this field is set.</p> |
| 30 | RO | 0h | Core | <p>Interrupt Pending (IP): Hardware sets the IP field whenever it detects an interrupt condition. Interrupt condition is defined as:</p> <ul style="list-style-type: none"> When primary fault logging is active, an interrupt condition occurs when hardware records a fault through one of the Fault Recording registers and sets the PPF field in Fault Status register. If the PPF field was already set at the time of recording a fault, it is not treated as a new interrupt condition. When advanced fault logging is active, an interrupt condition occurs when hardware records a fault in the first fault record (at index 0) of the current fault log and sets the APF field in the Advanced Fault Log register. If the APF field was already set at the time of detecting/recording a fault, it is not treated as a new interrupt condition. <p>The IP field is kept set by hardware while the interrupt message is held pending. The interrupt message could be held pending due to interrupt mask (IM field) being set, or due to other transient hardware conditions.</p> <p>The IP field is cleared by hardware as soon as the interrupt message pending condition is serviced.</p> <p>This could be due to either:</p> <ul style="list-style-type: none"> Hardware issuing the interrupt message due to either change in the transient hardware condition that caused interrupt message to be held pending or due to software clearing the IM field. Software servicing the interrupting condition through one of the following ways: <ul style="list-style-type: none"> When primary fault logging is active, software clearing the Fault (F) field in all the Fault Recording registers with faults, causing the PPF field in Fault Status register to be evaluated as clear. When advanced fault logging is active, software clearing the APF field in Advanced Fault Log register. |
| 29:0 | RO | 00000000h | Core | Reserved |



12.1.10 FEDATA_REG—Fault Event Data Register

B/D/F/Type: 0/0/0/VCOPREMAP
 Address Offset: 3C-3Fh
 Default Value: 00000000h
 Access: RO, R/W
 Size: 32 bits

This Register specifies the interrupt message data.

| Bit | Access | Default Value | RST/PWR | Description |
|-------|--------|---------------|---------|--------------------------------------------------------------------------------------------------------------------------------------------------------------------------------------------------------------------------------|
| 31:16 | RO | 0000h | Core | Extended Interrupt Message Data (EIMD): This field is valid only for implementations supporting 32-bit MSI data fields. Hardware implementations supporting only 16-bit MSI data may treat this field as read only (0). |
| 15:0 | R/W | 0000h | Core | Interrupt message data (IMD): Data value in the fault-event interrupt message. |

12.1.11 FEADDR_REG—Fault Event Address Register

B/D/F/Type: 0/0/0/VCOPREMAP
 Address Offset: 40-43h
 Default Value: 00000000h
 Access: RO, R/W
 Size: 32 bits

This register specifies the interrupt message address.

| Bit | Access | Default Value | RST/PWR | Description |
|------|--------|---------------|---------|-------------------------------------------------------------------------------------------------------------------------------------------------------------------------------|
| 31:2 | R/W | 00000000h | Core | Message address (MA): When fault events are enabled, the contents of this register specify the DWord aligned address (bits 31:2) for the MSI memory write transaction. |
| 1:0 | RO | 0h | Core | Reserved |



12.1.12 FEUADDR_REG—Fault Event Upper Address Register

B/D/F/Type: 0/0/0/VCOPREMAP
Address Offset: 44-47h
Default Value: 00000000h
Access: RO
Size: 32 bits

This register specifies the interrupt message address. For platforms supporting only interrupt messages in the 32-bit address range, this register is treated as read-only (0).

| Bit | Access | Default Value | RST/PWR | Description |
|------|--------|---------------|---------|-----------------------------------------------------------------------------------------------------------------------------------------------------------------------------------------------------------------------------------------------------------------------------------------------------------------------------------------------------------------------------------------------------------------|
| 31:0 | RO | 00000000h | Core | <p>Message upper address (MUA): This field needs to be implemented only if hardware supports 64-bit message address. If implemented, the contents of this register specify the upper 32-bits of a 64-bit MSI write transaction. If hardware does not support 64-bit messages, the register is treated as read only (0).</p> <p>NOTE: This field is reserved as this feature is not supported.</p> |



12.1.13 AFLOG_REG—Advanced Fault Log Register

B/D/F/Type: 0/0/0/VCOPREMAP
 Address Offset: 58-5Fh
 Default Value: 0000000000000000h
 Access: RO
 Size: 64 bits

This register specifies the base address of memory-resident fault-log region. This register is treated as read only (0) for implementations not supporting advanced translation fault logging (AFL field reported as 0 in the Capability register). This register is sticky and can be cleared only through powergood reset or via software clearing the RW1C fields by writing a 1.

| Bit | Access | Default Value | RST/PWR | Description |
|-------|--------|--------------------|---------|-----------------------------------------------------------------------------------------------------------------------------------------------------------------------------------------------------------------------------------------------------------------------------------------------------------------------------------------------------------------------------------------------------------------------------------------------------------------------------------------------------------------------------------------------------------------------|
| 63:12 | RO | 000000000 0000h | Core | <p>Fault Log Address (FLA): This field specifies the base of size-aligned fault-log region in system memory. Hardware may ignore and not implement bits 63:HAW, where HAW is the host address width.</p> <p>Software specifies the base address and size of the fault log region through this register, and programs it in hardware through the SFL field in the Global Command register. When implemented, reads of this field returns value that was last programmed to it.</p> <p>NOTE: This field is reserved as this feature is not supported.</p> |
| 11:9 | RO | 0h | Core | <p>Fault Log Size (FLS): This field specifies the size of the fault log region pointed by the FLA field.</p> <p>The size of the fault log region is $2X * 4KB$, where X is the value programmed in this register.</p> <p>When implemented, reads of this field returns value that was last programmed to it.</p> <p>NOTE: This field is reserved as this feature is not supported.</p> |
| 8:0 | RO | 0s | Core | Reserved |



12.1.14 PMEN_REG—Protected Memory Enable Register

B/D/F/Type: 0/0/0/VCOPREMAP
 Address Offset: 64-67h
 Default Value: 00000000h
 Access: RO, R/W
 Size: 32 bits

This register is used to enable the DMA protected memory regions setup through the PLMBASE, PLMLIMIT, PHMBASE, PHMLIMIT registers. When LT.CMD.LOCK.PMRC command is invoked, this register is locked (treated RO). When LT.CMD.UNLOCK.PMRC command is invoked, this register is unlocked (treated as R/W). This register is always treated as RO (0) for implementations not supporting protected memory regions (PLMR and PHMR fields reported as 0 in the Capability register).

| Bit | Access | Default Value | RST/PWR | Description |
|------|--------|---------------|---------|--------------------------------------------------------------------------------------------------------------------------------------------------------------------------------------------------------------------------------------------------------------------------------------------------------------------------------------------------------------------------------------------------------------------------------------------------------------------------------------------------------------------------------------------------------------------------------------------------------------------------------------------------------------------------------------------------------------------------------------------------------------------------------------------------------------------------------------------------------------------------------------------------------------------------------------------------------------------------------------------------------------------------------------------------------------------------------------------------------------------------------------------------------------------------------------------------------------------------------------------------------------------------------------------------------------------------------------------------------------------------------------------------------------------------------------------------------------------------------------------------------------------------------------------------------------------------------------------------------------------------|
| 31 | R/W | 0h | Core | <p>Enable Protected Memory (EPM): This field controls DMA accesses to the protected low-memory and protected high-memory regions.</p> <p>0 = DMA accesses to protected memory regions are handled as follows:</p> <ul style="list-style-type: none"> — If DMA-remapping hardware is not enabled, DMA requests (including those to protected regions) are not blocked. — If DMA-remapping hardware is enabled, DMA requests are translated per the programming of the DMA-remapping structures. Software may program the DMA-remapping structures to allow or block DMA to the protected memory regions. <p>1 = DMA accesses to protected memory regions are handled as follows:</p> <ul style="list-style-type: none"> — If DMA-remapping hardware is not enabled, DMA to protected memory regions are blocked. These DMA requests are not recorded or reported as DMA-remapping faults. — If DMA-remapping hardware is enabled, hardware may or may not block DMA to the protected memory region(s). Software must not depend on hardware protection of the protected memory regions, and must ensure the DMA-remapping structures are properly programmed to not allow DMA to the protected memory regions. <p>Hardware reports the status of the protected memory enable/disable operation through the PRS field in this register.</p> <p>Hardware implementations supporting DMA draining must drain any in-flight translated DMA requests queued within the root complex before indicating the protected memory region as enabled through the PRS field.</p> |
| 30:1 | RO | 00000000h | Core | Reserved |
| 0 | RO | 0h | Core | <p>Protected Region Status (PRS): This field indicates the status of protected memory region.</p> <p>0 = Protected memory region(s) not enabled. 1 = Protected memory region(s) enabled.</p> |



12.1.15 PLMBASE_REG—Protected Low-Memory Base Register

B/D/F/Type: 0/0/0/VCOPREMAP
 Address Offset: 68-6Bh
 Default Value: 00000000h
 Access: R/W, RO
 Size: 32 bits

This register is used to setup the base address of DMA protected low-memory region. This register must be setup before enabling protected memory through PMEN_REG, and must not be updated when protected memory regions are enabled.

When LT.CMD.LOCK.PMRC command is invoked, this register is locked (treated RO). When LT.CMD.UNLOCK.PMRC command is invoked, this register is unlocked (treated as R/W). This register is always treated as RO for implementations not supporting protected low memory region (PLMR field reported as 0 in the Capability register). The alignment of the protected low memory region base depends on the number of reserved bits (N) of this register. Software may determine the value of N by writing all 1's to this register, and finding most significant zero bit position with 0 in the value read back from the register. Bits N:0 of this register is decoded by hardware as all 0s.

| Bit | Access | Default Value | RST/PWR | Description |
|-------|--------|---------------|---------|-------------------------------------------------------------------------------------------------------------------------------------------------------------------------------------------------------------------------------|
| 31:21 | R/W | 000h | Core | Protected Low-Memory Base (PLMB): This register specifies the base of size aligned, protected low-memory region in system memory. The protected low-memory region has a minimum size of 2 MB and must be size aligned. |
| 20:0 | RO | 000000h | Core | Reserved |



12.1.16 PLMLIMIT_REG—Protected Low-Memory Limit Register

B/D/F/Type: 0/0/0/VCOPREMAP
Address Offset: 6C-6Fh
Default Value: 00000000h
Access: R/W, RO
Size: 32 bits

This register is used to setup the limit address of DMA protected low-memory region. This register must be setup before enabling protected memory through PMEN_REG, and must not be updated when protected memory regions are enabled.

When LT.CMD.LOCK.PMRC command is invoked, this register is locked (treated RO).

When LT.CMD.UNLOCK.PMRC command is invoked, this register is unlocked (treated as R/W).

This register is always treated as RO for implementations not supporting protected low memory region (PLMR field reported as 0 in the Capability register). The alignment of the protected low memory region limit depends on the number of reserved bits (N) of this register. Software may determine the value of N by writing all 1s to this register, and finding most significant zero bit position with 0 in the value read back from the register. Bits N:0 of the limit register are decoded by hardware as all 1s. The Protected low-memory base and limit registers functions as follows:

- Programming the protected low-memory base and limit registers with the same value in bits 31:(N+1) specifies a protected low-memory region of size 2(N+1) bytes.
- Programming the protected low-memory limit register with a value less than the protected low-memory base register disables the protected low-memory region.

| Bit | Access | Default Value | RST/PWR | Description |
|-------|--------|---------------|---------|--------------------------------------------------------------------------------------------------------------------------------------------------------|
| 31:21 | R/W | 000h | Core | Protected Low-Memory Limit (PLML): This field specifies the last host physical address of the DMA protected low-memory region in system memory. |
| 20:0 | RO | 000000h | Core | Reserved |



12.1.17 PHMBASE_REG—Protected High-Memory Base Register

B/D/F/Type: 0/0/0/VCOPREMAP
 Address Offset: 70-77h
 Default Value: 0000000000000000h
 Access: RO, R/W
 Size: 64 bits

This register is used to setup the base address of DMA protected high-memory region. This register must be setup before enabling protected memory through PMEN_REG, and must not be updated when protected memory regions are enabled. When LT.CMD.LOCK.PMRC command is invoked, this register is locked (treated RO). When LT.CMD.UNLOCK.PMRC command is invoked, this register is unlocked (treated as R/W). This register is always treated as RO for implementations not supporting protected high memory region (PHMR field reported as 0 in the Capability register). The alignment of the protected high memory region base depends on the number of reserved bits (N) of this register. Software may determine the value of N by writing all 1s to this register, and finding most significant zero bit position below host address width (HAW) in the value read back from the register. Bits N:0 of the limit register is decoded by hardware as all 0s.

| Bit | Access | Default Value | RST/PWR | Description |
|-------|--------|------------------|---------|-------------------------------------------------------------------------------------------------------------------------------------------------------------------------------------------------------------------------------------------------------------------------------------------------------|
| 63:21 | R/W | 000000000 00h | Core | Protected High-Memory Base (PHMB): This register specifies the base of size aligned, protected memory region in system memory. Hardware may not use bits 63:HAW, where HAW is the host address width. The protected high-memory region has a minimum size of 2 MB and must be size aligned. |
| 20:0 | RO | 000000h | Core | Reserved |

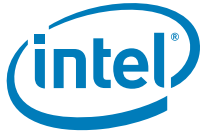

12.1.18 PHMLIMIT_REG—Protected High-Memory Limit Register

B/D/F/Type: 0/0/0/VCOPREMAP
 Address Offset: 78-7Fh
 Default Value: 0000000000000000h
 Access: R/W, RO
 Size: 64 bits

This register is used to setup the limit address of DMA protected high-memory region. This register must be setup before enabling protected memory through PMEN_REG, and must not be updated when protected memory regions are enabled. When LT.CMD.LOCK.PMRC command is invoked, this register is locked (treated RO). When LT.CMD.UNLOCK.PMRC command is invoked, this register is unlocked (treated as R/W). This register is always treated as RO for implementations not supporting protected high memory region (PHMR field reported as 0 in the Capability register). The alignment of the protected high memory region limit depends on the number of reserved bits (N) of this register. Software may determine the value of N by writing all 1s to this register, and finding most significant zero bit position below host address width (HAW) in the value read back from the register. Bits N:0 of the limit register is decoded by hardware as all 1s. The protected high-memory base and limit registers functions as follows.

- Programming the protected low-memory base and limit registers with the same value in bits HAW:(N+1) specifies a protected low-memory region of size 2(N+1) bytes.
- Programming the protected high-memory limit register with a value less than the protected high-memory base register disables the protected high-memory region.

| Bit | Access | Default Value | RST/PWR | Description |
|-------|--------|------------------|---------|------------------------------------------------------------------------------------------------------------------------------------------------------------------------------------------------------------------------------------|
| 63:21 | R/W | 000000000 00h | Core | Protected High-Memory Limit (PHML): This register specifies the last host physical address of the DMA protected high-memory region in system memory. Hardware may not use bits 63:HAW, where HAW is the host address width. |
| 20:0 | RO | 000000h | Core | Reserved |

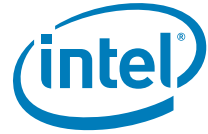

12.1.19 IVA_REG—Invalidate Address Register

B/D/F/Type: 0/0/0/VCOPREMAP
 Address Offset: 100-107h
 Default Value: 0000000000000000h
 Access: W, RO
 Size: 64 bits

This register provides the DMA address whose corresponding IOTLB entry needs to be invalidated through the corresponding IOTLB Invalidate register. This register is a write only register. The value returned on reads of this register is undefined. There is an IVA_REG for each IOTLB Invalidation unit supported by hardware.

| Bit | Access | Default Value | RST/PWR | Description |
|-------|--------|-------------------|---------|-------------------------------------------------------------------------------------------------------------------------------------------------------------------------------------------------------------------------------------------------------------------------------------------------------------------------------------------------------------------------------------------------------------------------------------------------------------------------------------------------------------------------------------------------------------------------------------------------------------------------------------------------------------------------------------------------------------------------------------------------------------------------------------------------------------------------------------------------------------------|
| 63:12 | W | 00000000 0000h | Core | <p>Address (Addr): Software provides the DMA address that needs to be page-selectively invalidated. To request a page-selective invalidation request to hardware, software must first write the appropriate fields in this register, and then issue appropriate page-selective invalidate command through the IOTLB_REG.</p> <p>Hardware ignores bits 63:N, where N is the maximum guest address width (MGAW) supported.</p> <p>Value returned on read of this field is undefined.</p> |
| 11:7 | RO | 00h | Core | Reserved |
| 6 | W | 0h | Core | <p>Invalidation Hint (IH): The field provides hints to hardware to preserve or flush the non-leaf (page-directory) entries that may be cached in hardware.</p> <p>0 = Software may have modified both leaf and non-leaf page-table entries corresponding to mappings specified in the ADDR and AM fields. On a pageselective invalidation request, hardware must flush both the cached leaf and non-leaf page-table entries corresponding to mappings specified by ADDR and AM fields.</p> <p>Value returned on read of this field is undefined.</p> <p>1 = Software has not modified any non-leaf page-table entries corresponding to mappings specified in the ADDR and AM fields. On a page-selective invalidation request, hardware may preserve the cached non-leaf page-table entries corresponding to mappings specified by ADDR and AM fields.</p> |



| Bit | Access | Default Value | RST/PWR | Description | | | | | | | | | | | | | | | | | | | | | | | | | | | | | | |
|------------|------------------|---------------|---------|----------------------------------------------------------------------------------------------------------------------------------------------------------------------------------------------------------------------------------------------------------------------------------------------------------------------------------------------------------------------------------------------------------------------------------------------------------------------------------------------------------------------------------------------------------------------------------------------------------------------------------------------------------------------------------------------------------------------------------------------------------------------------------------------------------------------------------------------------------------------------------------------------------------------------------------------------------------------------------------------------------------------------------------------------------------------------------------------|------------|------------------|----------|---|-----|---|---|----|---|---|-------|---|---|-------|---|---|-------|----|---|-------|----|---|-------|----|---|-------|-----|---|-------|-----|
| 5:0 | W | 00h | Core | <p>Address Mask (AM): The value in this field specifies the number of low order bits of the ADDR field that must be masked for the invalidation operation. Mask field enables software to request invalidation of contiguous mappings for size-aligned regions. For example: Mask Value ADDR bits masked Pages invalidated</p> <table border="1"> <thead> <tr> <th>Mask Value</th> <th>Addr bits masked</th> <th>Pg inval</th> </tr> </thead> <tbody> <tr> <td>0</td> <td>Nil</td> <td>1</td> </tr> <tr> <td>1</td> <td>12</td> <td>2</td> </tr> <tr> <td>2</td> <td>13:12</td> <td>4</td> </tr> <tr> <td>3</td> <td>14:12</td> <td>8</td> </tr> <tr> <td>4</td> <td>15:12</td> <td>16</td> </tr> <tr> <td>5</td> <td>16:12</td> <td>32</td> </tr> <tr> <td>6</td> <td>17:12</td> <td>64</td> </tr> <tr> <td>7</td> <td>18:12</td> <td>128</td> </tr> <tr> <td>8</td> <td>19:12</td> <td>256</td> </tr> </tbody> </table> <p>Hardware implementations report the maximum supported mask value through the Capability register. Value returned on read of this field is undefined.</p> | Mask Value | Addr bits masked | Pg inval | 0 | Nil | 1 | 1 | 12 | 2 | 2 | 13:12 | 4 | 3 | 14:12 | 8 | 4 | 15:12 | 16 | 5 | 16:12 | 32 | 6 | 17:12 | 64 | 7 | 18:12 | 128 | 8 | 19:12 | 256 |
| Mask Value | Addr bits masked | Pg inval | | | | | | | | | | | | | | | | | | | | | | | | | | | | | | | | |
| 0 | Nil | 1 | | | | | | | | | | | | | | | | | | | | | | | | | | | | | | | | |
| 1 | 12 | 2 | | | | | | | | | | | | | | | | | | | | | | | | | | | | | | | | |
| 2 | 13:12 | 4 | | | | | | | | | | | | | | | | | | | | | | | | | | | | | | | | |
| 3 | 14:12 | 8 | | | | | | | | | | | | | | | | | | | | | | | | | | | | | | | | |
| 4 | 15:12 | 16 | | | | | | | | | | | | | | | | | | | | | | | | | | | | | | | | |
| 5 | 16:12 | 32 | | | | | | | | | | | | | | | | | | | | | | | | | | | | | | | | |
| 6 | 17:12 | 64 | | | | | | | | | | | | | | | | | | | | | | | | | | | | | | | | |
| 7 | 18:12 | 128 | | | | | | | | | | | | | | | | | | | | | | | | | | | | | | | | |
| 8 | 19:12 | 256 | | | | | | | | | | | | | | | | | | | | | | | | | | | | | | | | |



12.2 DMI VC1 Remap Engine Registers

Table 27. DMI VC1 Remap Engine Register Address Map

| Address Offset | Register Symbol | Register Name | Default Value | Access |
|----------------|-----------------|--------------------------------------|-----------------------------------------------|---------------------|
| 0–3h | VER_REG | Version Register | 00000010h | RO |
| 8–Fh | CAP_REG | Capability Register | 00C9008020 E30272h | RO |
| 10–17h | ECAP_REG | Extended Capability Register | 0000000000 001000h | RO |
| 18–1Bh | GCMD_REG | Global Command Register | 00000000h | RO, W |
| 1C–1Fh | GSTS_REG | Global Status Register | 00000000h | RO |
| 20–27h | RTADDR_REG | Root-Entry Table Address Register | 0000000000 000000h | R/W, RO |
| 28–2Fh | CCMD_REG | Context Command Register | 0000000000 000000h | RO, R/W, W |
| 34–37h | FSTS_REG | Fault Status Register | 00000000h | RO, RO/P, R/WC/P |
| 38–3Bh | FECTL_REG | Fault Event Control Register | 80000000h | RO, R/W |
| 3C–3Fh | FEDATA_REG | Fault Event Data Register | 00000000h | RO, R/W |
| 40–43h | FEADDR_REG | Fault Event Address Register | 00000000h | R/W, RO |
| 44–h | FEUADDR_REG | Fault Event Upper Address Register | 00000000h | RO |
| 58–5Fh | AFLOG_REG | Advanced Fault Log Register | 0000000000 000000h | RO |
| 64–67h | PMEN_REG | Protected Memory Enable Register | 00000000h | RO, R/W |
| 68–6Bh | PLMBASE_REG | Protected Low-Memory Base Register | 00000000h | R/W, RO |
| 6C–6Fh | PLMLIMIT_REG | Protected Low-Memory Limit Register | 00000000h | R/W, RO |
| 70–77h | PHMBASE_REG | Protected High-Memory Base Register | 0000000000 000000h | R/W, RO |
| 78–7Fh | PHMLIMIT_REG | Protected High-Memory Limit Register | 0000000000 000000h | RO, R/W |
| 100–107h | IVA_REG | Invalidate Address Register | 0000000000 000000h | W, RO |
| 108–10Fh | IOTLB_REG | IOTLB Invalidate Register | 0000000000 000000h | R/W, RO |
| 200–20Fh | FRCD_REG | Fault Recording Registers | 0000000000 0000000000 0000000000 00h | RO, RO/P, R/WC/P |



12.2.1 VER_REG—Version Register

B/D/F/Type: 0/0/0/DMIVC1REMAP
 Address Offset: 0-3h
 Default Value: 00000010h
 Access: RO
 Size: 32 bits

This register reports the architecture version supported. Backward compatibility for the architecture is maintained with new revision numbers, allowing software to load DMA-remapping drivers written for prior architecture versions.

| Bit | Access | Default Value | RST/PWR | Description |
|------|--------|---------------------------------|---------|-----------------------------------------------------------------------------------------------|
| 31:8 | RO | 00000000 00000000 000000b | Core | Reserved |
| 7:4 | RO | 0001b | Core | Major Version number (MAX): This field indicates supported architecture version. |
| 3:0 | RO | 0000b | Core | Minor Version number (MIN): This field indicates supported architecture minor version. |

12.2.2 CAP_REG—Capability Register

B/D/F/Type: 0/0/0/DMIVC1REMAP
 Address Offset: 8-Fh
 Default Value: 00C9008020E30272h
 Access: RO
 Size: 64 bits

This register reports general DMA remapping hardware capabilities

| Bit | Access | Default Value | RST/PWR | Description |
|-------|--------|---------------|---------|---------------------------------------------------------------------------------------------------------------------------------------------------------------------------------------------------------------------------------------------------------------------------------------------------------------------------------------|
| 63:56 | RO | 00h | Core | Reserved |
| 55 | RO | 1b | Core | DMA Read Draining (DRD): Indicates supported architecture version. 0 = On IOTLB invalidations, hardware does not support draining of translated DMA read requests queued within the root complex. 1 = On IOTLB invalidations, hardware supports draining of translated DMA read requests queued within the root complex. |
| 54 | RO | 1b | Core | DMA Write Draining (DWD): 0 = On IOTLB invalidations, hardware does not support draining of translated DMA writes queued within the root complex. 1 = On IOTLB invalidations, hardware supports draining of translated DMA writes queued within the root complex. |
| 53:48 | RO | 001001b | Core | Maximum Address Mask Value (MAMV): The value in this field indicates the maximum supported value for the Address Mask (AM) field in the Invalidation Address (IVA_REG) register. |



| Bit | Access | Default Value | RST/PWR | Description |
|-------|--------|---------------|---------|------------------------------------------------------------------------------------------------------------------------------------------------------------------------------------------------------------------------------------------------------------------------------------------------------------------------------------------------------------------------------------------------------------------------------------------------------------------------------------------------------------------|
| 47:40 | RO | 00000000b | Core | <p>Number of Faultrecording Registers (NFR): This field indicates a value of N-1, where N is the number of fault recording registers supported by hardware.</p> <p>Implementations must support at least one fault recording register (NFR = 0) for each DMAremapping hardware unit in the platform.</p> <p>The maximum number of fault recording registers per DMA-remapping hardware unit is 256.</p> |
| 39 | RO | 1b | Core | <p>Page Selective Invalidation Support (PSI):</p> <p>0 = Indicates that the DMAr engine does not support page selective invalidations</p> <p>1 = Indicates the DMAr engine does support page-selective IOTLB invalidations. The MAMV field indicates the maximum number of contiguous translations that may be invalidated in a single request.</p> |
| 38 | RO | 0b | Core | Reserved |
| 37:34 | RO | 0000b | Core | <p>Super page Support (SPS): This field indicates the super page sizes supported by hardware.</p> <p>A value of 1 in any of these bits indicates the corresponding super-page size is supported. The super-page sizes corresponding to various bit positions within this field are:</p> <p>0 = 21-bit offset to page frame</p> <p>1 = 30-bit offset to page frame</p> <p>2 = 39-bit offset to page frame</p> <p>3 = 48-bit offset to page frame</p> |
| 33:24 | RO | 020h | Core | <p>Fault-recording Register offset (FRO): This field specifies the location to the first fault recording register relative to the register base address of this DMA-remapping hardware unit. If the register base address is X, and the value reported in this field is Y, the address for the first fault recording register is calculated as $X + (16 * Y)$.</p> |
| 23 | RO | 1b | Core | <p>Isochrony (Isoch):</p> <p>0 = Indicates this DMA-remapping hardware unit has no critical isochronous requesters in its scope.</p> <p>1 = Indicates this DMA-remapping hardware unit has one or more critical isochronous requesters in its scope.</p> <p>To ensure isochronous performance, software must ensure invalidation operations do not impact active DMA streams. This implies that when DMA is active, software perform page-selective invalidations (instead of coarser invalidations).</p> |
| 22 | RO | 1b | Core | <p>Zero Length Read (ZLR):</p> <p>0 = Indicates the remapping hardware unit blocks (and treats as fault) zero length DMA read requests to write-only pages.</p> <p>1 = Indicates the remapping hardware unit supports zero length DMA read requests to write-only pages.</p> |

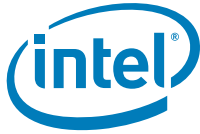

| Bit | Access | Default Value | RST/PWR | Description |
|-------|--------|---------------|---------|---------------------------------------------------------------------------------------------------------------------------------------------------------------------------------------------------------------------------------------------------------------------------------------------------------------------------------------------------------------------------------------------------------------------------------------------------------------------------------------------------------------------------------------------------------------------------------------------------------------------------------------------------------------------------------------------------------------------------------------------------------------------------------------------------------------------------------------------------------------------------------------------------------------|
| 21:16 | RO | 100011b | Core | <p>Maximum Guest Address Width (MGAW): This field indicates the maximum DMA virtual addressability supported by remapping hardware.</p> <p>The Maximum Guest Address Width (MGAW) is computed as $(N+1)$, where N is the value reported in this field. For example, a hardware implementation supporting 48-bit MGAW reports a value of 47 (101111b) in this field.</p> <p>If the value in this field is X, DMA requests to addresses above $2(x+1)-1$ are always blocked by hardware.</p> <p>Guest addressability for a given DMA request is limited to the minimum of the value reported through this field and the adjusted guest address width of the corresponding page-table structure. (Adjusted guest address widths supported by hardware are reported through the SAGAW field).</p> |
| 15:13 | RO | 000b | Core | Reserved |
| 12:8 | RO | 00010b | Core | <p>Supported Adjusted Guest Address Widths (SAGAW): This 5-bit field indicates the supported adjusted guest address widths (which in turn represents the levels of page-table walks) supported by the hardware implementation.</p> <p>A value of 1 in any of these bits indicates the corresponding adjusted guest address width is supported. The adjusted guest address widths corresponding to various bit positions within this field are:</p> <ul style="list-style-type: none"> 0 = 30-bit AGAW (2-level page table) 1 = 39-bit AGAW (3-level page table) 2 = 48-bit AGAW (4-level page table) 3 = 57-bit AGAW (5-level page table) 4 = 64-bit AGAW (6-level page table) <p>Software must ensure that the adjusted guest address width used to setup the page tables is one of the supported guest address widths reported in this field.</p> |
| 7 | RO | 0b | Core | <p>Caching Mode (CM):</p> <ul style="list-style-type: none"> 0 = Hardware does not cache not present and erroneous entries in the context-cache and IOTLB. Invalidation are not required for modifications to individual not present or invalid entries. However, any modifications that result in decreasing the effective permissions or partial permission increases require invalidations for them to be effective. 1 = Hardware may cache not present and erroneous mappings in the context-cache or IOTLB. Any software updates to the DMA-remapping structures (including updates to not-present or erroneous entries) require explicit invalidation. <p>Hardware implementations are recommended to support operation corresponding to CM=0.</p> |



| Bit | Access | Default Value | RST/PWR | Description |
|-----|--------|---------------|---------|--------------------------------------------------------------------------------------------------------------------------------------------------------------------------------------------------------------------------------------------------------------------------------------------------------------------------------------------------------------------------------------------------------------------------------------------------------------------------------------------------------------------------------------------------------------------------------------------------------------------------------------------------------------------------------------------------------------------------------------------------------------------------------------------------------------------------------------|
| 6 | RO | 1b | Core | <p>Protected High-Memory Region (PHMR): 0 = Indicates protected high-memory region not supported. 1 = Indicates protected high-memory region is supported. DMA-remapping hardware implementations on Intel TXT platforms supporting main memory above 4 GB are required to support protected high-memory region.</p> |
| 5 | RO | 1b | Core | <p>Protected Low-Memory Region (PLMR): 0 = 0: Indicates protected low-memory region not supported. 1 = 1: Indicates protected low-memory region is supported. DMA-remapping hardware implementations on Intel TXT platforms are required to support protected low-memory region.</p> |
| 4 | RO | 1b | Core | <p>Required Write-Buffer Flushing (RWBF): 0 = Indicates no write-buffer flushing needed to ensure changes to memory-resident structures are visible to hardware. 1 = Indicates software must explicitly flush the write buffers (through the Global Command register) to ensure updates made to memory-resident DMA-remapping structures are visible to hardware.</p> |
| 3 | RO | 0b | Core | <p>Advanced Fault Logging (AFL): 0 = Indicates advanced fault logging not supported. Only primary fault logging is supported. 1 = Indicates advanced fault logging is supported.</p> |
| 2:0 | RO | 010b | Core | <p>Number of domains supported (ND): 000 = Hardware supports 4-bit domain-IDs with support for up to 16 domains. 001 = Hardware supports 6-bit domain-IDs with support for up to 64 domains. 010 = Hardware supports 8-bit domain-IDs with support for up to 256 domains. 011 = Hardware supports 10-bit domain-IDs with support for up to 1024 domains. 100 = Hardware supports 12-bit domain-IDs with support for up to 4K domains. 100 = Hardware supports 14-bit domain-IDs with support for up to 16K domains. 110 = Hardware supports 16-bit domain-IDs with support for up to 64K domains. 111 = Reserved.</p> |



12.2.3 ECAP_REG—Extended Capability Register

B/D/F/Type: 0/0/0/DMIVC1REMAP
 Address Offset: 10-17h
 Default Value: 0000000000001000h
 Access: RO
 Size: 64 bits

This register reports DMA-remapping hardware extended capabilities

| Bit | Access | Default Value | RST/PWR | Description |
|-------|--------|---------------|---------|------------------------------------------------------------------------------------------------------------------------------------------------------------------------------------------------------------------------------------------------------------------------------------------------------------------------------------------------------------------------------------------------------------------------------------------------------------------------------------------------------|
| 63:24 | RO | 0s | Core | Reserved |
| 23:20 | RO | 0000b | Core | Maximum Handle Mask Value (MHMV): The value in this field indicates the maximum supported value for the Handle Mask (HM) field in the interrupt entry cache invalidation descriptor (<i>iec_inv_dsc</i>). This field is valid only when the IR field is reported as Set. |
| 19:18 | RO | 00b | Core | Reserved |
| 17:8 | RO | 010h | Core | Invalidation Unit Offset (IVO): This field specifies the location to the first IOTLB invalidation unit relative to the register base address of this DMA-remapping hardware unit. If the register base address is X, and the value reported in this field is Y, the address for the first IOTLB invalidation unit is calculated as $X + (16 * Y)$. If N is the value reported in NIU field, the address for the last IOTLB invalidation unit is calculated as $X + (16 * Y) + (16 * N)$. |
| 7 | RO | 0b | Core | Snoop Control (SC): 0 = Hardware does not support 1-setting of the SNP field in the page-table entries. 1 = Hardware supports the 1-setting of the SNP field in the page-table entries. |
| 6 | RO | 0b | Core | Pass Through (PT): 0 = Hardware does not support passthrough translation type in context entries. 1 = Hardware supports pass-through translation type in context entries. |
| 5 | RO | 0b | Core | Caching Hints (CH): 0 = Hardware does not support IOTLB caching hints (ALH and EH fields in context-entries are treated as reserved). 1 = Hardware supports IOTLB caching hints through the ALH and EH fields in context-entries. |
| 4 | RO | 0b | Core | Extended Interrupt Mode (EIM): 0 = Hardware supports only 8-bit APICIDs (Legacy Interrupt Mode) on Intel®64 and IA-32 platforms and 16-bit APIC-IDs on Itanium™ platforms. 1 = Hardware supports Extended Interrupt Mode (32-bit APIC-IDs) on Intel®64 platforms. This field is valid only when the IR field is reported as Set. |



| Bit | Access | Default Value | RST/PWR | Description |
|-----|--------|---------------|---------|---------------------------------------------------------------------------------------------------------------------------------------------------------------------------------------------------------------------------------------------------------------------------------------------------------|
| 3 | RO | 0b | Core | Interrupt Remapping Support (IR): 0 = Hardware does not support interrupt remapping. 1 = Hardware supports interrupt remapping. Implementations reporting this field as Set must also support Queued Invalidation (QI = 1b). |
| 2 | RO | 0b | Core | Device IOTLB Support (DI): 0 = Hardware does not support device- IOTLBs. 1 = Hardware supports Device-IOTLBs. Implementations reporting this field as Set must also support Queued Invalidation (QI = 1b). NOTE: This field is reserved as this feature is not supported. |
| 1 | RO | 0b | Core | Queued Invalidation Support (QI): 0 = Hardware does not support queued invalidations. 1 = Hardware supports queued invalidations. |
| 0 | RO | 0b | Core | Coherency (C): 0 = Hardware accesses to the root, context, and page table structures are non-coherent (non-snoop). 1 = Hardware accesses to the root, context, and page table structures are coherent (snoop). Hardware writes to the advanced fault log is required to be coherent. |



12.2.4 GCMD_REG—Global Command Register

B/D/F/Type: 0/0/0/DMIVC1REMAP
 Address Offset: 18-1Bh
 Default Value: 00000000h
 Access: RO, W
 Size: 32 bits

This register controls DMA-remapping hardware. If multiple control fields in this register need to be modified, software must serialize through multiple writes to this register.

| Bit | Access | Default Value | RST/PWR | Description |
|-----|--------|---------------|---------|-----------------------------------------------------------------------------------------------------------------------------------------------------------------------------------------------------------------------------------------------------------------------------------------------------------------------------------------------------------------------------------------------------------------------------------------------------------------------------------------------------------------------------------------------------------------------------------------------------------------------------------------------------------------------------------------------------------------------------------------------------------------------------------------------------------------------------------------------------------------------------------------------------------------------------------------------------------------------------------------------------------------------------------------------------------------------------------------------------------------------------------------------------------------------------------------------------------------------------------------------------------------------------------------------------------------------------------------------------------------------------------------------------------------------------------------------------------------------------------------------------------------------------------------------------------------------------------------------------------------------------|
| 31 | W | 0b | Core | <p>Translation Enable (TE): Software writes to this field to request hardware to enable/disable DMA-remapping hardware.</p> <p>0 = Disable DMA-remapping hardware 1 = Enable DMA-remapping hardware</p> <p>Hardware reports the status of the translation enable operation through the TES field in the Global Status register.</p> <p>Before enabling (or re-enabling) DMA-remapping hardware through this field, software must:</p> <ul style="list-style-type: none"> • Setup the DMA-remapping structures in memory • Flush the write buffers (through WBF field), if write buffer flushing is reported as required. • Set the root-entry table pointer in hardware (through SRTP field). • Perform global invalidation of the context-cache and global invalidation of IOTLB • If advanced fault logging supported, setup fault log pointer (through SFL field) and enable advanced fault logging (through EAFL field). <p>There may be active DMA requests in the platform when software updates this field. Hardware must enable or disable remapping logic only at deterministic transaction boundaries, so that any in-flight transaction is either subject to remapping or not at all.</p> <p>Hardware implementations supporting DMA draining must drain any in-flight translated DMA read/write requests queued within the root complex before completing the translation enable command and reflecting the status of the command through the TES field in the GSTS_REG.</p> <p>Value returned on read of this field is undefined.</p> |



| Bit | Access | Default Value | RST/PWR | Description |
|-----|--------|---------------|---------|------------------------------------------------------------------------------------------------------------------------------------------------------------------------------------------------------------------------------------------------------------------------------------------------------------------------------------------------------------------------------------------------------------------------------------------------------------------------------------------------------------------------------------------------------------------------------------------------------------------------------------------------------------------------------------------------------------------------------------------------------------------------------------------------------------------------------------------------------------------------------------------------------------------------------------------------------------------------------------------------------------------------------------------------------------------------------------------------------------------------------------------------------------------------------------------------------------------------------------------------------------------------------------------------------------|
| 30 | W | 0b | Core | <p>Set Root Table Pointer (SRTP): Software sets this field to set/update the root-entry table pointer used by hardware. The root-entry table pointer is specified through the Root-entry Table Address register.</p> <p>Hardware reports the status of the root table pointer set operation through the RTPS field in the Global Status register.</p> <p>The root table pointer set operation must be performed before enabling or re-enabling (after disabling) DMAremapping hardware.</p> <p>After a root table pointer set operation, software must globally invalidate the context cache followed by global invalidate of IOTLB. This is required to ensure hardware uses only the remapping structures referenced by the new root table pointer, and not any stale cached entries.</p> <p>While DMA-remapping hardware is active, software may update the root table pointer through this field. However, to ensure valid in-flight DMA requests are deterministically remapped, software must ensure that the structures referenced by the new root table pointer are programmed to provide the same remapping results as the structures referenced by the previous root table pointer.</p> <p>Clearing this bit has no effect.</p> <p>Value returned on read of this field is undefined.</p> |
| 29 | RO | 0b | Core | <p>Set Fault Log (SFL): This field is valid only for implementations supporting advanced fault logging. If advanced fault logging is not supported, writes to this field are ignored.</p> <p>Software sets this field to request hardware to set/update the fault-log pointer used by hardware. The fault-log pointer is specified through Advanced Fault Log register.</p> <p>Hardware reports the status of the fault log set operation through the FLS field in the Global Status register. The fault log pointer must be set before enabling advanced fault logging (through EAFL field). Once advanced fault logging is enabled, the fault log pointer may be updated through this field while DMA-remapping hardware is active.</p> <p>Clearing this bit has no effect. Value returned on read of this field is undefined.</p> <p>NOTE: This field is reserved as this feature is not supported.</p> |



| Bit | Access | Default Value | RST/PWR | Description |
|-----|--------|---------------|---------|--------------------------------------------------------------------------------------------------------------------------------------------------------------------------------------------------------------------------------------------------------------------------------------------------------------------------------------------------------------------------------------------------------------------------------------------------------------------------------------------------------------------------------------------------------------------------------------------------------------------------------------------------------------------------------------------------------------------------------------------------------------------------------------------------------------------------------------------------------------------------------------------------------------------------------------------------------------------------------|
| 28 | RO | 0b | Core | <p>Enable Advanced Fault Logging (EAFL): This field is valid only for implementations supporting advanced fault logging. If advanced fault logging is not supported, writes to this field are ignored.</p> <p>Software writes to this field to request hardware to enable or disable advanced fault logging.</p> <p>0 = Disable advanced fault logging. In this case, translation faults are reported through the Fault Recording registers.</p> <p>1 = Enable use of memory-resident fault log. When enabled, translation faults are recorded in the memory-resident log. The fault log pointer must be set in hardware (through SFL field) before enabling advanced fault logging.</p> <p>Hardware reports the status of the advanced fault logging enable operation through the AFLS field in the Global Status register.</p> <p>Value returned on read of this field is undefined.</p> <p>NOTE: This field is reserved as this feature is not supported.</p> |
| 27 | W | 0b | Core | <p>Write Buffer Flush (WBF): This bit is valid only for implementations requiring write buffer flushing. If write buffer flushing is not required, writes to this field are ignored.</p> <p>Software sets this field to request hardware to flush the root-complex internal write buffers. This is done to ensure any updates to the memory-resident DMA-remapping structures are not held in any internal write posting buffers. Refer to Section 9.1 for details on write-buffer flushing requirements.</p> <p>Hardware reports the status of the write buffer flushing operation through the WBFS field in the Global Status register.</p> <p>Clearing this bit has no effect. Value returned on read of this field is undefined.</p> <p>NOTE: This field is reserved as this feature is not supported.</p> |
| 26 | RO | 0b | Core | <p>Queued Invalidation Enable (QIE): This field is valid only for implementations supporting queued invalidations. Software writes to this field to enable or disable queued invalidations.</p> <p>0 = Disable queued invalidations.</p> <p>1 = Enable use of queued invalidations.</p> <p>Hardware reports the status of queued invalidation enable operation through QIES field in the Global Status register. Refer to Section 6.2.2 for software requirements for enabling/disabling queued invalidations.</p> <p>The value returned on a read of this field is undefined.</p> <p>NOTE: This field is reserved as this feature is not supported.</p> |

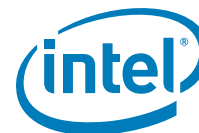

| Bit | Access | Default Value | RST/PWR | Description |
|-----|--------|---------------|---------|-----------------------------------------------------------------------------------------------------------------------------------------------------------------------------------------------------------------------------------------------------------------------------------------------------------------------------------------------------------------------------------------------------------------------------------------------------------------------------------------------------------------------------------------------------------------------------------------------------------------------------------------------------------------------------------------------------------------------------------------------------------------------------------------------------------------------------------------------------------------------------------------------------------------------------------------------------------------------------------------------------------------------------------------------------------------------------------------------------------------------------------------------------------------------------------------------------------------------------------------------------------------------------------------------------------------------------------------------------------------------------------------------------------------------------------------------------------------------------------------------------------------------------------------------------------------------------------------------------------------------------------------------------------------------------------------------------|
| 25 | RO | 0b | Core | <p>Interrupt Remapping Enable (IRE): This field is valid only for implementations supporting interrupt remapping. 0 = Disable interrupt-remapping hardware 1 = Enable interrupt-remapping hardware Hardware reports the status of the interrupt remapping enable operation through the IRES field in the Global Status register. There may be active interrupt requests in the platform when software updates this field. Hardware must enable or disable interrupt-remapping logic only at deterministic transaction boundaries, so that any in-flight interrupts are either subject to remapping or not at all. Hardware implementations must drain any in-flight interrupts requests queued in the Root-Complex before completing the interrupt-remapping enable command and reflecting the status of the command through the IRES field in the Global Status register. The value returned on a read of this field is undefined.</p> <p>NOTES:This field is reserved as this feature is not supported.</p> |
| 24 | RO | 0b | Core | <p>Set Interrupt Remap Table Pointer (SIRTP): This field is valid only for implementations supporting interrupt-remapping. Software sets this field to set/update the interrupt remapping table pointer used by hardware. The interrupt remapping table pointer is specified through the Interrupt Remapping Table Address register. Hardware reports the status of the interrupt remapping table pointer set operation through the IRTPS field in the Global Status register. The interrupt remap table pointer set operation must be performed before enabling or re-enabling (after disabling) interrupt-remapping hardware through the IRE field. After an interrupt remap table pointer set operation, software must globally invalidate the interrupt entry cache. This is required to ensure hardware uses only the interrupt-remapping entries referenced by the new interrupt remap table pointer, and not any stale cached entries. While interrupt remapping is active, software may update the interrupt remapping table pointer through this field. However, to ensure valid in-flight interrupt requests are deterministically remapped, software must ensure that the structures referenced by the new interrupt remap table pointer are programmed to provide the same remapping results as the structures referenced by the previous interrupt remap table pointer. Clearing this bit has no effect. The value returned on a read of this field is undefined.</p> <p>NOTE: This field is reserved as this feature is not supported.</p> |



| Bit | Access | Default Value | RST/PWR | Description |
|------|--------|---------------|---------|------------------------------------------------------------------------------------------------------------------------------------------------------------------------------------------------------------------------------------------------------------------------------------------------------------------------------------------------------------------------------------------------------------------------------------------------------------------------------------------------------------------------------------------------------------------------------------------------------------------------------------------------------------------------------------------------------------------------------------------------------------------------------------------------------------------------------------------------------------------------------------------------------------------------------------------------------------|
| 23 | RO | 0b | Core | <p>Compatibility Format Interrupt (CFI): This field is valid only for Intel® 64 implementations supporting interrupt-remapping. Software writes to this field to enable or disable Compatibility Format interrupts on Intel® 64 platforms. The value in this field is effective only when interrupt-remapping is enabled and Legacy Interrupt Mode is active.</p> <p>0 = Block Compatibility format interrupts. 1 = Process Compatibility format interrupts as pass-through (bypass interrupt remapping).</p> <p>Hardware reports the status of updating this field through the CFIS field in the Global Status register.</p> <p>Refer to Section 5.4.1 for details on Compatibility Format interrupt requests.</p> <p>The value returned on a read of this field is undefined.</p> <p>NOTE: This field is not implemented on Itanium™ implementations.</p> <p>NOTE: This field is reserved as this feature is not supported.</p> |
| 22:0 | RO | 000000h | Core | Reserved |

12.2.5 GSTS_REG—Global Status Register

B/D/F/Type: 0/0/0/DMIVC1REMAP
 Address Offset: 1C-1Fh
 Default Value: 00000000h
 Access: RO
 Size: 32 bits

This register reports general DMA-remapping hardware status.

| Bit | Access | Default Value | RST/PWR | Description |
|-----|--------|---------------|---------|--------------------------------------------------------------------------------------------------------------------------------------------------------------------------------------------------------------------------------------------------------------------------------------------------------------------------------------------------------------------------------------------------|
| 31 | RO | 0b | Core | <p>Translation Enable Status (TES): This field indicates the status of DMA-remapping hardware.</p> <p>0 = DMA-remapping hardware is not enabled 1 = DMA-remapping hardware is enabled</p> |
| 30 | RO | 0b | Core | <p>Root Table Pointer Status (RTPS): This field indicates the status of the root- table pointer in hardware.</p> <p>This field is cleared by hardware when software sets the SRTP field in the Global Command register. This field is set by hardware when hardware completes the set root-table pointer operation using the value provided in the Root-Entry Table Address register.</p> |



| Bit | Access | Default Value | RST/PWR | Description |
|------|--------|---------------|---------|---------------------------------------------------------------------------------------------------------------------------------------------------------------------------------------------------------------------------------------------------------------------------------------------------------------------------------------------------------------------------------------------------------------------------------------------------------------------------------------|
| 29 | RO | 0b | Core | <p>Fault Log Status (FLS): This field is valid only for implementations supporting advanced fault logging. This field indicates the status of the fault-log pointer in hardware.</p> <p>This field is cleared by hardware when software sets the SFL field in the Global Command register. This field is set by hardware when hardware completes the set fault-log pointer operation using the value provided in the Advanced Fault Log register.</p> |
| 28 | RO | 0b | Core | <p>Advanced Fault Logging Status (AFLS): This field is valid only for implementations supporting advanced fault logging.</p> <p>This field indicates advanced fault logging status. 0 = Advanced Fault Logging is not enabled 1 = Advanced Fault Logging is enabled</p> |
| 27 | RO | 0b | Core | <p>Write Buffer Flush Status (WBFS): This bit is valid only for implementations requiring write buffer flushing.</p> <p>This field indicates the status of the write buffer flush operation. This field is set by hardware when software sets the WBF field in the Global Command register. This field is cleared by hardware when hardware completes the write buffer flushing operation.</p> |
| 26 | RO | 0b | Core | <p>Queued Invalidation Enable Status (QIES): This field indicates queued invalidation enable status. 0 = queued invalidation is not enabled 1 = queued invalidation is enabled</p> |
| 25 | RO | 0b | Core | <p>Interrupt Remapping Enable Status (IRES): This field indicates the status of Interrupt-remapping hardware. 0 = Interrupt-remapping hardware is not enabled 1 = Interrupt-remapping hardware is enabled</p> |
| 24 | RO | 0b | Core | <p>Interrupt Remapping Table Pointer Status (IRTPS): This field indicates the status of the interrupt remapping table pointer in hardware.</p> <p>This field is cleared by hardware when software sets the SIRTTP field in the Global Command register. This field is Set by hardware when hardware completes the set interrupt remap table pointer operation using the value provided in the Interrupt Remapping Table Address register.</p> |
| 23 | RO | 0b | Core | <p>Compatibility Format Interrupt Status (CFIS): This field indicates the status of Compatibility format interrupts on Intel®64 implementations supporting interrupt-remapping. The value reported in this field is applicable only when interrupt-remapping is enabled and Legacy interrupt mode is active. 0 = Compatibility format interrupts are blocked. 1 = Compatibility format interrupts are processed as pass-through (bypassing interrupt remapping).</p> |
| 22:0 | RO | 000000h | Core | Reserved |

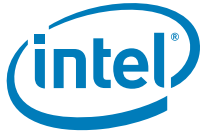

12.2.6 RTADDR_REG—Root-Entry Table Address Register

B/D/F/Type: 0/0/0/DMIVC1REMAP
Address Offset: 20-27h
Default Value: 0000000000000000h
Access: R/W, RO
Size: 64 bits

This register provides the base address of root-entry table.

| Bit | Access | Default Value | RST/PWR | Description |
|-------|--------|--------------------|---------|------------------------------------------------------------------------------------------------------------------------------------------------------------------------------------------------------------------------------------------------------------------------------------------------------------------------------------------------------------------------------------------------------------------------------------------------------------------|
| 63:12 | R/W | 000000000 0000h | Core | Root table address (RTA): This field points to the base of page aligned, 4 KB-sized root-entry table in system memory. Hardware may ignore and not implement bits 63:HAW, where HAW is the host address width. Software specifies the base address of the root-entry table through this register, and programs it in hardware through the SRTP field in the Global Command register. Reads of this register returns value that was last programmed to it. |
| 11:0 | RO | 000h | Core | Reserved |

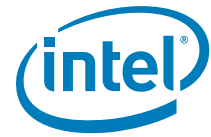

12.2.7 CCMD_REG—Context Command Register

B/D/F/Type: 0/0/0/DMIVC1REMAP
 Address Offset: 28-2Fh
 Default Value: 0000000000000000h
 Access: RO, R/W, W
 Size: 64 bits

This register is used to manage context cache. The act of writing the uppermost byte of the CCMD_REG with ICC field set causes the hardware to perform the context-cache invalidation.

| Bit | Access | Default Value | RST/PWR | Description |
|-----|--------|---------------|---------|------------------------------------------------------------------------------------------------------------------------------------------------------------------------------------------------------------------------------------------------------------------------------------------------------------------------------------------------------------------------------------------------------------------------------------------------------------------------------------------------------------------------------------------------------------------------------------------------------------------------------------------------------------------------------------------------------------------------------------------------------------------------------------------------------------------------------------------------------------------------------------------------------------------------------------------------------------------------------------------------------------------------------------------------------------------------------------------------------------------------------------------------------------------------------------------------------------------------------------------------------------------------------------------------------------------------------------------------------------------------------------------------------------------------|
| 63 | R/W | 0h | Core | <p>Invalidate Context-Cache (ICC): Software requests invalidation of context-cache by setting this field. Software must also set the requested invalidation granularity by programming the CIRG field.</p> <p>Software must read back and check the ICC field to be clear to confirm the invalidation is complete. Software must not update this register when this field is set.</p> <p>Hardware clears the ICC field to indicate the invalidation request is complete. Hardware also indicates the granularity at which the invalidation operation was performed through the CAIG field. Software must not submit another invalidation request through this register while the ICC field is set.</p> <p>Software must submit a context cache invalidation request through this field only when there are no invalidation requests pending at this DMA-remapping hardware unit. Refer to Section 9 for software programming requirements.</p> <p>Since information from the context-cache may be used by hardware to tag IOTLB entries, software must perform domain-selective (or global) invalidation of IOTLB after the context cache invalidation has completed.</p> <p>Hardware implementations reporting write-buffer flushing requirement (RWBF=1 in Capability register) must implicitly perform a write buffer flushing before reporting invalidation complete to software through the ICC field.</p> |



| Bit | Access | Default Value | RST/PWR | Description |
|-------|--------|---------------|---------|--------------------------------------------------------------------------------------------------------------------------------------------------------------------------------------------------------------------------------------------------------------------------------------------------------------------------------------------------------------------------------------------------------------------------------------------------------------------------------------------------------------------------------------------------------------------------------------------------------------------------------------------------------------------------------------------------------------------------------------------------------------------------------------------------------------------------------------------------------------------------------------------------------------------------------------------------------|
| 62:61 | R/W | 0h | Core | <p>Context Invalidation Request Granularity (CIRG): Software provides the requested invalidation granularity through this field when setting the ICC field.</p> <p>00 = Reserved. 01 = Global Invalidation request. 10 = Domain-selective invalidation request. The target domain-ID must be specified in the DID field. 11 = Device-selective invalidation request. The target source-ID(s) must be specified through the SID and FM fields, and the domain-ID (that was programmed in the context-entry for these device(s)) must be provided in the DID field.</p> <p>Hardware implementations may process an invalidation request by performing invalidation at a coarser granularity than requested. Hardware indicates completion of the invalidation request by clearing the ICC field. At this time, hardware also indicates the granularity at which the actual invalidation was performed through the CAIG field.</p> |
| 60:59 | RO | 0h | Core | <p>Context Actual Invalidation Granularity (CAIG): Hardware reports the granularity at which an invalidation request was processed through the CAIG field at the time of reporting invalidation completion (by clearing the ICC field).</p> <p>00 = Reserved. 01 = Global Invalidation performed. This could be in response to a global, domain-selective or device-selective invalidation request. 10 = Domain-selective invalidation performed using the domain-ID specified by software in the DID field. This could be in response to a domain-selective or device-selective invalidation request. 11 = Device-selective invalidation performed using the source-ID and domain-ID specified by software in the SID and FM fields. This can only be in response to a device-selective invalidation request.</p> |
| 58:34 | RO | 000000000h | Core | Reserved |
| 33:32 | W | 0h | Core | <p>Function Mask (FM): This field specifies which bits of the function number portion (least significant three bits) of the SID field to mask when performing device-selective invalidations.</p> <p>00 = No bits in the SID field masked. 01 = Mask most significant bit of function number in the SID field. 10 = Mask two most significant bit of function number in the SID field. 11 = Mask all three bits of function number in the SID field.</p> <p>The device(s) specified through the FM and SID fields must correspond to the domain-ID specified in the DID field.</p> <p>Value returned on read of this field is undefined.</p> |



| Bit | Access | Default Value | RST/PWR | Description |
|-------|--------|---------------|---------|---------------------------------------------------------------------------------------------------------------------------------------------------------------------------------------------------------------------------------------------------------------------------------------------------------------------------------------------------------------------------------------------------------------------------------------------------------------------------------------------------------------------------------------------|
| 31:16 | W | 0000h | Core | Source ID (SID): This field indicates the source-ID of the device whose corresponding context-entry needs to be selectively invalidated. This field along with the FM field must be programmed by software for device-selective invalidation requests. Value returned on read of this field is undefined. |
| 15:0 | R/W | 0000h | Core | Domain-ID (DID): This field indicates the id of the domain whose context-entries needs to be selectively invalidated. This field must be programmed by software for both domain-selective and device-selective invalidation requests. The Capability register reports the domain-ID width supported by hardware. Software must ensure that the value written to this field is within this limit. Hardware may ignore and not implement bits 15:N where N is the supported domain-ID width reported in the capability register. |

12.2.8 FSTS_REG—Fault Status Register

B/D/F/Type: 0/0/0/DMIVC1REMAP
 Address Offset: 34-37h
 Default Value: 00000000h
 Access: RO, RO/P, R/WC/P
 Size: 32 bits

This register indicates the primary fault logging status.

| Bit | Access | Default Value | RST/PWR | Description |
|-------|--------|---------------|---------|---------------------------------------------------------------------------------------------------------------------------------------------------------------------------------------------------------------------------------------------------------------------------------------------------------------------------------------------------------------------------------------------------------------------------------------------------------------------|
| 31:16 | RO | 0000h | Core | Reserved |
| 15:8 | RO/P | 00h | Core | Fault Record Index (FRI): This field is valid only when the PPF field is set. The FRI field indicates the index (from base) of the fault recording register to which the first pending fault was recorded when the PPF field was set by hardware. Valid values for this field are from 0 to N, where N is the value reported through NFR field in the Capability register. The value read from this field is undefined when the PPF field is clear. |
| 7 | RO | 0b | Core | Reserved |
| 6 | RO | 0b | Core | Invalidation Time-out Error (ITE): Hardware detected a Device-IOTLB invalidation completion time-out. At this time, a fault event may be generated based on the programming of the Fault Event Control register. Hardware implementations not supporting Device-IOTLBs implement this bit as Reserved. NOTE: This field is reserved as this feature is not supported. |



| Bit | Access | Default Value | RST/PWR | Description |
|-----|--------|---------------|---------|----------------------------------------------------------------------------------------------------------------------------------------------------------------------------------------------------------------------------------------------------------------------------------------------------------------------------------------------------------------------------------------------------------------------------------------------------------------------------------------------------------------------------------------------------------------------------------------------------------------------------------|
| 5 | RO | 0b | Core | <p>Invalidation Completion Error (ICE): Hardware received an unexpected or invalid Device-IOTLB invalidation completion. This could be due to either an invalid ITag or invalid source-ID in an invalidation completion response. At this time, a fault event may be generated based on the programming of the Fault Event Control register.</p> <p>Hardware implementations not supporting Device-IOTLBs implement this bit as Reserved.</p> <p>NOTE: This field is reserved as this feature is not supported.</p> |
| 4 | RO | 0b | Core | <p>Invalidation Queue Error (IQE): This field indicates that hardware detected an error associated with the invalidation queue. This could be due to either a hardware error while fetching a descriptor from the invalidation queue, or hardware detecting an erroneous or invalid descriptor in the invalidation queue. At this time, a fault event may be generated based on the programming of the Fault Event Control register.</p> <p>Hardware implementations not supporting queued invalidations implement this bit as Reserved.</p> <p>NOTE: This field is reserved as this feature is not supported.</p> |
| 3 | RO | 0b | Core | <p>Advanced Pending Fault (APF): When this field is Clear, hardware sets this field when the first fault record (at index 0) is written to a fault log. At this time, a fault event is generated based on the programming of the Fault Event Control register.</p> <p>Software writing 1 to this field clears it. Hardware implementations not supporting advanced fault logging implement this bit as Reserved.</p> <p>NOTE: This field is reserved as this feature is not supported.</p> |



| Bit | Access | Default Value | RST/PWR | Description |
|-----|--------|---------------|---------|-----------------------------------------------------------------------------------------------------------------------------------------------------------------------------------------------------------------------------------------------------------------------------------------------------------------------------------------------------------------------------------------------------------------------------------------------------------------------------------------------------------------------------------------------------------------------------------------------------------------------------------------------------------|
| 2 | RO | 0b | Core | <p>Advanced Fault Overflow (AFO): Hardware sets this field to indicate advanced fault log overflow condition. At this time, a fault event is generated based on the programming of the Fault Event Control register. Software writing 1 to this field clears it. Hardware implementations not supporting advanced fault logging implement this bit as Reserved.</p> <p>NOTE: This field is reserved as this feature is not supported.</p> |
| 1 | RO/P | 0h | Core | <p>Primary Pending Fault (PPF): This field indicates if there are one or more pending faults logged in the fault recording registers. Hardware computes this field as the logical OR of Fault (F) fields across all the fault recording registers of this DMA-remapping hardware unit.</p> <p>0 = No pending faults in any of the fault recording registers</p> <p>1 = One or more fault recording registers has pending faults. The FRI field is updated by hardware whenever the PPF field is set by hardware. Also, depending on the programming of Fault Event Control register, a fault event is generated when hardware sets this field.</p> |
| 0 | R/WC/P | 0h | Core | <p>Primary Fault Overflow (PFO): Hardware sets this field to indicate overflow of fault recording registers. Software writing 1 clears this field.</p> |

12.2.9 FECTL_REG—Fault Event Control Register

B/D/F/Type: 0/0/0/DMIVC1REMAP
 Address Offset: 38-3Bh
 Default Value: 80000000h
 Access: RO, R/W
 Size: 32 bits

This register specifies the fault event interrupt message control bits.

| Bit | Access | Default Value | RST/PWR | Description |
|-----|--------|---------------|---------|----------------------------------------------------------------------------------------------------------------------------------------------------------------------------------------------------------------------------------------------------------------------------------------------------------------------------------------------------------------------------------------------------------------------------|
| 31 | R/W | 1h | Core | <p>Interrupt Mask (IM):</p> <p>0 = No masking of interrupt. When a interrupt condition is detected, hardware issues an interrupt message (using the Fault Event Data & Fault Event Address register values).</p> <p>1 = This is the value on reset. Software may mask interrupt message generation by setting this field. Hardware is prohibited from sending the interrupt message when this field is set.</p> |

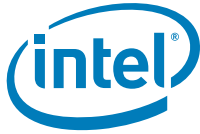

| Bit | Access | Default Value | RST/PWR | Description |
|------|--------|---------------|---------|-----------------------------------------------------------------------------------------------------------------------------------------------------------------------------------------------------------------------------------------------------------------------------------------------------------------------------------------------------------------------------------------------------------------------------------------------------------------------------------------------------------------------------------------------------------------------------------------------------------------------------------------------------------------------------------------------------------------------------------------------------------------------------------------------------------------------------------------------------------------------------------------------------------------------------------------------------------------------------------------------------------------------------------------------------------------------------------------------------------------------------------------------------------------------------------------------------------------------------------------------------------------------------------------------------------------------------------------------------------------------------------------------------------------------------------------------------------------------------------------------------------------------------------------------------------------------------------------------------------------------------------------------------------------------------------------------------------------------------------------------------------------------------------------------------------------------------------------------------------------------------------------------------------------------------------------------------------------------------------|
| 30 | RO | 0h | Core | <p>Interrupt Pending (IP): Hardware sets the IP field whenever it detects an interrupt condition. Interrupt condition is defined as:</p> <ul style="list-style-type: none"> When primary fault logging is active, an interrupt condition occurs when hardware records a fault through one of the Fault Recording registers and sets the PPF field in Fault Status register. If the PPF field was already set at the time of recording a fault, it is not treated as a new interrupt condition. When advanced fault logging is active, an interrupt condition occurs when hardware records a fault in the first fault record (at index 0) of the current fault log and sets the APF field in the Advanced Fault Log register. If the APF field was already set at the time of detecting/recording a fault, it is not treated as a new interrupt condition. <p>The IP field is kept set by hardware while the interrupt message is held pending. The interrupt message could be held pending due to interrupt mask (IM field) being set, or due to other transient hardware conditions.</p> <p>The IP field is cleared by hardware as soon as the interrupt message pending condition is serviced. This could be due to either:</p> <ul style="list-style-type: none"> Hardware issuing the interrupt message due to either change in the transient hardware condition that caused interrupt message to be held pending or due to software clearing the IM field. Software servicing the interrupting condition through one of the following ways: <ul style="list-style-type: none"> When primary fault logging is active, software clearing the Fault (F) field in all the Fault Recording registers with faults, causing the PPF field in Fault Status register to be evaluated as clear. When advanced fault logging is active, software clearing the APF field in Advanced Fault Log register. |
| 29:0 | RO | 00000000h | Core | Reserved |



12.2.10 FEDATA_REG—Fault Event Data Register

B/D/F/Type: 0/0/0/DMIVC1REMAP
 Address Offset: 3C-3Fh
 Default Value: 00000000h
 Access: RO, R/W
 Size: 32 bits

This register specifies the interrupt message data

| Bit | Access | Default Value | RST/PWR | Description |
|-------|--------|---------------|---------|--------------------------------------------------------------------------------------------------------------------------------------------------------------------------------------------------------------------------------|
| 31:16 | RO | 0000h | Core | Extended Interrupt Message Data (EIMD): This field is valid only for implementations supporting 32-bit MSI data fields. Hardware implementations supporting only 16-bit MSI data may treat this field as read only (0). |
| 15:0 | R/W | 0000h | Core | Interrupt message data (IMD): Data value in the fault-event interrupt message. |

12.2.11 FEADDR_REG—Fault Event Address Register

B/D/F/Type: 0/0/0/DMIVC1REMAP
 Address Offset: 40-43h
 Default Value: 00000000h
 Access: R/W, RO
 Size: 32 bits

This register specifies the interrupt message address.

| Bit | Access | Default Value | RST/PWR | Description |
|------|--------|---------------|---------|-------------------------------------------------------------------------------------------------------------------------------------------------------------------------------|
| 31:2 | R/W | 00000000h | Core | Message address (MA): When fault events are enabled, the contents of this register specify the DWord aligned address (bits 31:2) for the MSI memory write transaction. |
| 1:0 | RO | 0h | Core | Reserved |



12.2.12 FEUADDR_REG—Fault Event Upper Address Register

B/D/F/Type: 0/0/0/DMIVC1REMAP
Address Offset: 44-47h
Default Value: 00000000h
Access: RO
Size: 32 bits

This register specifies the interrupt message address. For platforms supporting only interrupt messages in the 32-bit address range, this register is treated as read-only (0).

| Bit | Access | Default Value | RST/PWR | Description |
|------|--------|---------------|---------|----------------------------------------------------------------------------------------------------------------------------------------------------------------------------------------------------------------------------------------------------------------------------------------------------------------------------------------------------------------------------------------------------------------------------------|
| 31:0 | RO | 00000000h | Core | <p>Message upper address (MUA): This register need to be implemented only if hardware supports 64-bit message address.</p> <p>If implemented, the contents of this register specify the upper 32-bits of a 64- bit MSI write transaction.</p> <p>If hardware does not support 64-bit messages, the register is treated as read-only (0).</p> <p>NOTE: This field is reserved as this feature is not supported.</p> |

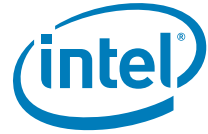

12.2.13 AFLOG_REG—Advanced Fault Log Register

B/D/F/Type: 0/0/0/DMIVC1REMAP
 Address Offset: 58-5Fh
 Default Value: 0000000000000000h
 Access: RO
 Size: 64 bits

This register specifies the base address of memory-resident fault-log region. This register is treated as read only (0) for implementations not supporting advanced translation fault logging (AFL field reported as 0 in the Capability register). This register is sticky and can be cleared only through powergood reset or via software clearing the RW1C fields by writing a 1.

| Bit | Access | Default Value | RST/PWR | Description |
|-------|--------|--------------------|---------|------------------------------------------------------------------------------------------------------------------------------------------------------------------------------------------------------------------------------------------------------------------------------------------------------------------------------------------------------------------------------------------------------------------------------------------------------------------------------------------------------------------------------------------------------------------------------|
| 63:12 | RO | 000000000 0000h | Core | <p>Fault Log Address (FLA): This field specifies the base of size-aligned fault-log region in system memory. Hardware may ignore and not implement bits 63:HAW, where HAW is the host address width.</p> <p>Software specifies the base address and size of the fault log region through this register, and programs it in hardware through the SFL field in the Global Command register.</p> <p>When implemented, reads of this field returns value that was last programmed to it.</p> <p>NOTE: This field is reserved as this feature is not supported.</p> |
| 11:9 | RO | 0h | Core | <p>Fault Log Size (FLS): This field specifies the size of the fault log region pointed by the FLA field.</p> <p>00 = 4 KB 01 = 8 KB 10 = 16 KB 11 = 32 KB</p> <p>When implemented, reads of this field returns value that was last programmed to it.</p> <p>NOTE: This field is reserved as this feature is not supported.</p> |
| 8:0 | RO | 00h | Core | Reserved |



12.2.14 PMEN_REG—Protected Memory Enable Register

B/D/F/Type: 0/0/0/DMIVC1REMAP
 Address Offset: 64-67h
 Default Value: 00000000h
 Access: RO, R/W
 Size: 32 bits

This register is used to enable the DMA protected memory regions setup through the PLMBASE, PLMLIMIT, PHMBASE, PHMLIMIT registers. When LT.CMD.LOCK.PMRC command is invoked, this register is locked (treated RO). When LT.CMD.UNLOCK.PMRC command is invoked, this register is unlocked (treated as R/W). This register is always treated as RO (0) for implementations not supporting protected memory regions (PLMR and PHMR fields reported as 0 in the Capability register).

| Bit | Access | Default Value | RST/PWR | Description |
|------|--------|---------------|---------|--------------------------------------------------------------------------------------------------------------------------------------------------------------------------------------------------------------------------------------------------------------------------------------------------------------------------------------------------------------------------------------------------------------------------------------------------------------------------------------------------------------------------------------------------------------------------------------------------------------------------------------------------------------------------------------------------------------------------------------------------------------------------------------------------------------------------------------------------------------------------------------------------------------------------------------------------------------------------------------------------------------------------------------------------------------------------------------------------------------------------------------------------------------------------------------------------------------------------------------------------------------------------------------------------------------------------------------------------------------------------------------------------------------------------------------------------------------------------------------------------------------------------------------------------------------------------------------------------------------------------|
| 31 | R/W | 0h | Core | <p>Enable Protected Memory (EPM): This field controls DMA accesses to the protected low-memory and protected high-memory regions.</p> <p>0 = DMA accesses to protected memory regions are handled as follows:</p> <ul style="list-style-type: none"> — If DMA-remapping hardware is not enabled, DMA requests (including those to protected regions) are not blocked. — If DMA-remapping hardware is enabled, DMA requests are translated per the programming of the DMA-remapping structures. Software may program the DMA-remapping structures to allow or block DMA to the protected memory regions. <p>1 = DMA accesses to protected memory regions are handled as follows:</p> <ul style="list-style-type: none"> — If DMA-remapping hardware is not enabled, DMA to protected memory regions are blocked. These DMA requests are not recorded or reported as DMA-remapping faults. — If DMA-remapping hardware is enabled, hardware may or may not block DMA to the protected memory region(s). Software must not depend on hardware protection of the protected memory regions, and must ensure the DMA-remapping structures are properly programmed to not allow DMA to the protected memory regions. <p>Hardware reports the status of the protected memory enable/disable operation through the PRS field in this register.</p> <p>Hardware implementations supporting DMA draining must drain any in-flight translated DMA requests queued within the root complex before indicating the protected memory region as enabled through the PRS field.</p> |
| 30:1 | RO | 00000000h | Core | Reserved |
| 0 | RO | 0h | Core | <p>Protected Region Status (PRS): This field indicates the status of protected memory region.</p> <p>0 = Protected memory region(s) not enabled. 1 = Protected memory region(s) enabled.</p> |



12.2.15 PLMBASE_REG—Protected Low-Memory Base Register

B/D/F/Type: 0/0/0/DMIVC1REMAP
 Address Offset: 68-6Bh
 Default Value: 00000000h
 Access: R/W, RO
 Size: 32 bits

This register is used to setup the base address of DMA protected low-memory region. This register must be setup before enabling protected memory through PMEN_REG, and must not be updated when protected memory regions are enabled. When LT.CMD.LOCK.PMRC command is invoked, this register is locked (treated RO). When LT.CMD.UNLOCK.PMRC command is invoked, this register is unlocked (treated as R/W). This register is always treated as RO for implementations not supporting protected low memory region (PLMR field reported as 0 in the Capability register). The alignment of the protected low memory region base depends on the number of reserved bits (N) of this register. Software may determine the value of N by writing all 1s to this register, and finding most significant zero bit position with 0 in the value read back from the register. Bits N:0 of this register is decoded by hardware as all 0s.

| Bit | Access | Default Value | RST/PWR | Description |
|-------|--------|---------------|---------|-------------------------------------------------------------------------------------------------------------------------------------------------------------------------------------------------------------------------------|
| 31:21 | R/W | 000h | Core | Protected Low-Memory Base (PLMB): This register specifies the base of size aligned, protected low-memory region in system memory. The protected low-memory region has a minimum size of 2 MB and must be size aligned. |
| 20:0 | RO | 000000h | Core | Reserved |



12.2.16 PLMLIMIT_REG—Protected Low-Memory Limit Register

B/D/F/Type: 0/0/0/DMIVC1REMAP
Address Offset: 6C-6Fh
Default Value: 00000000h
Access: R/W, RO
Size: 32 bits

This register is used to setup the limit address of DMA protected low-memory region. This register must be setup before enabling protected memory through PMEN_REG, and must not be updated when protected memory regions are enabled. When LT.CMD.LOCK.PMRC command is invoked, this register is locked (treated RO). When LT.CMD.UNLOCK.PMRC command is invoked, this register is unlocked (treated as R/W). This register is always treated as RO for implementations not supporting protected low memory region (PLMR field reported as 0 in the Capability register). The alignment of the protected low memory region limit depends on the number of reserved bits (N) of this register. Software may determine the value of N by writing all 1s to this register, and finding most significant zero bit position with 0 in the value read back from the register. Bits N:0 of the limit register is decoded by hardware as all 1s. The Protected low-memory base & limit registers functions as follows:

- Programming the protected low-memory base and limit registers with the same value in bits 31:(N+1) specifies a protected low-memory region of size 2(N+1) bytes.
- Programming the protected low-memory limit register with a value less than the protected low-memory base register disables the protected low-memory region.

| Bit | Access | Default Value | RST/PWR | Description |
|-------|--------|---------------|---------|-----------------------------------------------------------------------------------------------------------------------------------------------------------|
| 31:21 | R/W | 000h | Core | Protected Low-Memory Limit (PLML): This register specifies the last host physical address of the DMA protected low-memory region in system memory. |
| 20:0 | RO | 000000h | Core | Reserved |



12.2.17 PHMBASE_REG—Protected High-Memory Base Register

B/D/F/Type: 0/0/0/DMIVC1REMAP
 Address Offset: 70-77h
 Default Value: 0000000000000000h
 Access: R/W, RO
 Size: 64 bits

This register is used to setup the base address of DMA protected high-memory region. This register must be setup before enabling protected memory through PMEN_REG, and must not be updated when protected memory regions are enabled. When LT.CMD.LOCK.PMRC command is invoked, this register is locked (treated RO). When LT.CMD.UNLOCK.PMRC command is invoked, this register is unlocked (treated as R/W). This register is always treated as RO for implementations not supporting protected high memory region (PHMR field reported as 0 in the Capability register). The alignment of the protected high memory region base depends on the number of reserved bits (N) of this register. Software may determine the value of N by writing all 1s to this register, and finding most significant zero bit position below host address width (HAW) in the value read back from the register. Bits N:0 of the limit register is decoded by hardware as all 0s.

| Bit | Access | Default Value | RST/PWR | Description |
|-------|--------|---------------|---------|--------------------------------------------------------------------------------------------------------------------------------------------------------------------------------------------------------------------------------------------------------------------------------------------------------|
| 63:21 | R/W | 0000000000h | Core | Protected High-Memory Base (PHMB): This field specifies the base of size aligned, protected memory region in system memory. Hardware may not utilize bits 63:HAW, where HAW is the host address width. The protected high-memory region has a minimum size of 2 MB and must be size aligned. |
| 20:0 | RO | 000000h | Core | Reserved |

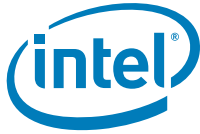

12.2.18 PHMLIMIT_REG—Protected High-Memory Limit Register

B/D/F/Type: 0/0/0/DMIVC1REMAP
 Address Offset: 78-7Fh
 Default Value: 0000000000000000h
 Access: RO, R/W
 Size: 64 bits

This register is used to setup the limit address of DMA protected high-memory region. This register must be setup before enabling protected memory through PMEN_REG, and must not be updated when protected memory regions are enabled. When LT.CMD.LOCK.PMRC command is invoked, this register is locked (treated RO). When LT.CMD.UNLOCK.PMRC command is invoked, this register is unlocked (treated as R/W). This register is always treated as RO for implementations not supporting protected high memory region (PHMR field reported as 0 in the Capability register). The alignment of the protected high memory region limit depends on the number of reserved bits (N) of this register. Software may determine the value of N by writing all 1s to this register, and finding most significant zero bit position below host address width (HAW) in the value read back from the register. Bits N:0 of the limit register is decoded by hardware as all 1s. The protected high-memory base and limit registers functions as follows:

- Programming the protected low-memory base and limit registers with the same value in bits HAW:(N+1) specifies a protected low-memory region of size 2(N+1) bytes.
- Programming the protected high-memory limit register with a value less than the protected high-memory base register disables the protected high-memory region.

| Bit | Access | Default Value | RST/PWR | Description |
|-------|--------|------------------|---------|---------------------------------------------------------------------------------------------------------------------------------------------------------------------------------------------------------------------------------|
| 63:21 | R/W | 000000000 00h | Core | Protected High-Memory Limit (PHML): This field specifies the last host physical address of the DMA protected high-memory region in system memory. Hardware may not use bits 63:HAW, where HAW is the host address width. |
| 20:0 | RO | 000000h | Core | Reserved |

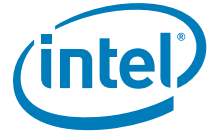

12.2.19 IVA_REG—Invalidate Address Register

B/D/F/Type: 0/0/0/DMIVC1REMAP
 Address Offset: 100-107h
 Default Value: 0000000000000000h
 Access: W, RO
 Size: 64 bits

This register provides the DMA address whose corresponding IOTLB entry needs to be invalidated through the corresponding IOTLB Invalidate register. This register is a write-only register. Value returned on reads of this register is undefined. There is an IVA_REG for each IOTLB Invalidation unit supported by hardware.

| Bit | Access | Default Value | RST/PWR | Description |
|-------|--------|---------------|---------|------------------------------------------------------------------------------------------------------------------------------------------------------------------------------------------------------------------------------------------------------------------------------------------------------------------------------------------------------------------------------------------------------------------------------------------------------------------------------------------------------------------------------------------------------------------------------------------------------------------------------------------------------------------------------------------------------------------------------------------------------------------------------------------------------------------------------------------------------------------|
| 63:12 | W | 0s | Core | <p>Address (Addr): Software provides the DMA address that needs to be page-selectively invalidated. To request a page-selective invalidation request to hardware, software must first write the appropriate fields in this register, and then issue appropriate page-selective invalidate command through the IOTLB_REG.</p> <p>Hardware ignores bits 63: N, where N is the maximum guest address width (MGAW) supported.</p> <p>Value returned on read of this field is undefined.</p> |
| 11:7 | RO | 0s | Core | Reserved |
| 6 | W | 0 | Core | <p>Invalidation Hint (IH): The field provides hint to hardware to preserve or flush the non-leaf (page-directory) entries that may be cached in hardware.</p> <p>0 = Software may have modified both leaf and non-leaf page-table entries corresponding to mappings specified in the ADDR and AM fields. On a pageselective invalidation request, hardware must flush both the cached leaf and non-leaf page-table entries corresponding to mappings specified by ADDR and AM fields.</p> <p>1 = Software has not modified any non-leaf page-table entries corresponding to mappings specified in the ADDR and AM fields. On a page-selective invalidation request, hardware may preserve the cached non-leaf page-table entries corresponding to mappings specified by ADDR and AM fields.</p> <p>Value returned on read of this field is undefined.</p> |

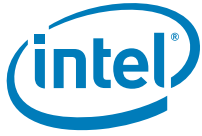

| Bit | Access | Default Value | RST/PWR | Description | | | | | | | | | | | | | | | | | | | | | | | | | | | | | | |
|------------|------------------|---------------|---------|---------------------------------------------------------------------------------------------------------------------------------------------------------------------------------------------------------------------------------------------------------------------------------------------------------------------------------------------------------------------------------------------------------------------------------------------------------------------------------------------------------------------------------------------------------------------------------------------------------------------------------------------------------------------------------------------------------------------------------------------------------------------------------------------------------------------------------------------------------------------------------------------------------------------------------------------------------------------------------------------------------------------------------------------------------------------------------------------------|------------|------------------|----------|---|-----|---|---|----|---|---|-------|---|---|-------|---|---|-------|----|---|-------|----|---|-------|----|---|-------|-----|---|-------|-----|
| 5:0 | W | 0s | Core | <p>Address Mask (AM): The value in this field specifies the number of low order bits of the ADDR field that must be masked for the invalidation operation. Mask field enables software to request invalidation of contiguous mappings for size-aligned regions. For example: Mask Value ADDR bits masked Pages invalidated.</p> <table border="1"> <thead> <tr> <th>Mask Value</th> <th>Addr bits masked</th> <th>Pg inval</th> </tr> </thead> <tbody> <tr> <td>0</td> <td>Nil</td> <td>1</td> </tr> <tr> <td>1</td> <td>12</td> <td>2</td> </tr> <tr> <td>2</td> <td>13:12</td> <td>4</td> </tr> <tr> <td>3</td> <td>14:12</td> <td>8</td> </tr> <tr> <td>4</td> <td>15:12</td> <td>16</td> </tr> <tr> <td>5</td> <td>16:12</td> <td>32</td> </tr> <tr> <td>6</td> <td>17:12</td> <td>64</td> </tr> <tr> <td>7</td> <td>18:12</td> <td>128</td> </tr> <tr> <td>8</td> <td>19:12</td> <td>256</td> </tr> </tbody> </table> <p>Hardware implementations report the maximum supported mask value through the Capability register. Value returned on read of this field is undefined.</p> | Mask Value | Addr bits masked | Pg inval | 0 | Nil | 1 | 1 | 12 | 2 | 2 | 13:12 | 4 | 3 | 14:12 | 8 | 4 | 15:12 | 16 | 5 | 16:12 | 32 | 6 | 17:12 | 64 | 7 | 18:12 | 128 | 8 | 19:12 | 256 |
| Mask Value | Addr bits masked | Pg inval | | | | | | | | | | | | | | | | | | | | | | | | | | | | | | | | |
| 0 | Nil | 1 | | | | | | | | | | | | | | | | | | | | | | | | | | | | | | | | |
| 1 | 12 | 2 | | | | | | | | | | | | | | | | | | | | | | | | | | | | | | | | |
| 2 | 13:12 | 4 | | | | | | | | | | | | | | | | | | | | | | | | | | | | | | | | |
| 3 | 14:12 | 8 | | | | | | | | | | | | | | | | | | | | | | | | | | | | | | | | |
| 4 | 15:12 | 16 | | | | | | | | | | | | | | | | | | | | | | | | | | | | | | | | |
| 5 | 16:12 | 32 | | | | | | | | | | | | | | | | | | | | | | | | | | | | | | | | |
| 6 | 17:12 | 64 | | | | | | | | | | | | | | | | | | | | | | | | | | | | | | | | |
| 7 | 18:12 | 128 | | | | | | | | | | | | | | | | | | | | | | | | | | | | | | | | |
| 8 | 19:12 | 256 | | | | | | | | | | | | | | | | | | | | | | | | | | | | | | | | |



12.2.20 IOTLB_REG—IOTLB Invalidate Register

B/D/F/Type: 0/0/0/DMIVC1REMAP
 Address Offset: 108-10Fh
 Default Value: 0000000000000000h
 Access: R/W, RO
 Size: 64 bits

This register is used to control page-table entry caching. The act of writing the upper byte of the IOTLB_REG with IVT field set causes the hardware to perform the IOTLB invalidation. There is an IOTLB_REG for each IOTLB Invalidation unit supported by hardware.

| Bit | Access | Default Value | RST/PWR | Description |
|-----|--------|---------------|---------|-----------------------------------------------------------------------------------------------------------------------------------------------------------------------------------------------------------------------------------------------------------------------------------------------------------------------------------------------------------------------------------------------------------------------------------------------------------------------------------------------------------------------------------------------------------------------------------------------------------------------------------------------------------------------------------------------------------------------------------------------------------------------------------------------------------------------------------------------------------------------------------------------------------------------------------------------------------------------------------------------------------------------------------------------------------------------------------------------------------------------------------------------------------------------------------------------------------------------------------------------------------------|
| 63 | R/W | 0 | Core | <p>Invalidate IOTLB (IVT): Software requests IOTLB invalidation by setting this field. Software must also set the requested invalidation granularity by programming the IIRG field.</p> <p>Hardware clears the IVT field to indicate the invalidation request is complete. Hardware also indicates the granularity at which the invalidation operation was performed through the IAIG field. Software must not submit another invalidation request through this register while the IVT field is set, nor update the associated Invalidate Address register.</p> <p>Software must not submit IOTLB invalidation requests through any of the IOTLB invalidation units when there is a context-cache invalidation request pending at this DMA-remapping hardware unit.</p> <p>When more than one IOTLB invalidation units are supported by a DMA-remapping hardware unit, software may submit IOTLB invalidation request through any of the currently free units while there are pending requests on other units.</p> <p>Hardware implementations reporting write-buffer flushing requirement (RWBF=1 in Capability register) must implicitly perform a write buffer flushing before reporting invalidation complete to software through the IVT field.</p> |



| Bit | Access | Default Value | RST/PWR | Description |
|-------|--------|---------------|---------|--------------------------------------------------------------------------------------------------------------------------------------------------------------------------------------------------------------------------------------------------------------------------------------------------------------------------------------------------------------------------------------------------------------------------------------------------------------------------------------------------------------------------------------------------------------------------------------------------------------------------------------------------------------------------------------------------------------------------------------------------------------------------------------------------------------------------------------------------------------------------------------------------------------------------------------------------------------------------------------------------------------------------------------------------------------------------------------------------------------------------------------------------------------------------------------------------------------------------------------------------------------------------------------------------------------------------------------------|
| 62:60 | R/W | 0s | Core | <p>IOTLB Invalidation Request Granularity (IIRG): When requesting hardware to invalidate the IOTLB (by setting the IVT field), software writes the requested invalidation granularity through this IIRG field. 000 = Reserved. 001 = Global invalidation request. 010 = Domain-selective invalidation request. The target domain-ID must be specified in the DID field. 011 = Domain-page-selective invalidation request. The target address, mask and invalidation hint must be specified in the Invalidate Address register, and the domain-ID must be provided in the DID field. 100–111 =Reserved. Hardware implementations may process an invalidation request by performing invalidation at a coarser granularity than requested. Hardware indicates completion of the invalidation request by clearing the IVT field. At this time, the granularity at which actual invalidation was performed is reported through the IAIG field.</p> |
| 59:57 | RO | 0s | Core | <p>IOTLB Actual Invalidation Granularity (IAIG): Hardware reports the granularity at which an invalidation request was processed through this field at the time of reporting invalidation completion (by clearing the IVT field). 000 = Reserved. This indicates hardware detected an incorrect invalidation request and ignored the request. Examples of incorrect invalidation requests include detecting an unsupported address mask value in Invalidate Address register for page-selective invalidation requests. 001 = Global Invalidation performed. This could be in response to a global, domain-selective, domain-page-selective, or device-page-selective invalidation request. 010 = Domain-selective invalidation performed using the domain-ID specified by software in the DID field. This could be in response to a domain-selective, domain-page-selective, or device-page-selective invalidation request. 011 = Domain-page-selective invalidation performed using the address, mask and hint specified by software in the Invalidate Address register and domain-ID specified in DID field. This can be in response to a domain-page-selective or device-page-selective invalidation request. 100 – 111 =Reserved.</p> |
| 56:50 | RO | 00h | Core | Reserved |



| Bit | Access | Default Value | RST/PWR | Description |
|-------|--------|---------------|---------|-----------------------------------------------------------------------------------------------------------------------------------------------------------------------------------------------------------------------------------------------------------------------------------------------------------------------------------------------------------------------------------------------------------------------------------------------------------------------------------------------------------------------------------------------------------------------------------------------------------------------------------------------------------------------------------------------------------------------------------------------------------------|
| 49 | R/W | 000000h | Core | <p>Drain Reads (DR): This field is ignored by hardware if the DRD field is reported as clear in the Capability register. When DRD field is reported as set in the Capability register, the following encodings are supported for this field:</p> <p>0 = Hardware may complete the IOTLB invalidation without draining any translated DMA reads that are queued in the root-complex and yet to be processed.</p> <p>1 = Hardware must drain all/relevant translated DMA reads that are queued in the root-complex before indicating IOTLB invalidation completion to software.</p> <p>A DMA read request to system memory is defined as drained when root-complex has finished fetching all of its read response data from memory.</p> |
| 48 | R/W | 00h | Core | <p>Drain Writes (DW): This field is ignored by hardware if the DWD field is reported as clear in the Capability register. When DWD field is reported as set in the Capability register, the following encodings are supported for this field:</p> <p>0 = Hardware may complete the IOTLB invalidation without draining any translated DMA writes that are queued in the root-complex for processing.</p> <p>1 = Hardware must drain all/relevant translated DMA writes that are queued in the root-complex before indicating IOTLB invalidation completion to software.</p> <p>A DMA write request to system memory is defined as drained when the effects of the write is visible to processor accesses to all addresses targeted by the DMA write.</p> |
| 47:32 | R/W | 0000h | Core | <p>Domain-ID (DID): This field indicates the id of the domain whose IOTLB entries needs to be selectively invalidated. This field must be programmed by software for domain-selective, domainpage-selective and device-page-selective invalidation requests.</p> <p>The Capability register reports the domain-ID width supported by hardware. Software must ensure that the value written to this field is within this limit.</p> <p>Hardware may ignore and not implement bits 47: (32+N) where N is the supported domain-ID width reported in the capability register.</p> |
| 31:0 | RO | 00000000h | Core | Reserved |



12.2.21 FRCD_REG—Fault Recording Registers

B/D/F/Type: 0/0/0/DMIVC1REMAP
 Address Offset: 200-20Fh
 Default Value: 00000000000000000000000000000000h
 Access: RO, RO/P, R/WC/P
 Size: 128 bits

This registers is used to record DMA-remapping fault information when primary fault logging is active. Hardware reports the number and location of fault recording registers through the Capability register. This register is relevant only for primary fault logging. These registers are sticky and can be cleared only through powergood reset or via software clearing the RW1C fields by writing a 1.

| Bit | Access | Default Value | RST/PWR | Description |
|---------|--------|---------------|---------|------------------------------------------------------------------------------------------------------------------------------------------------------------------------------------------------------------------------------------------------------------------------------------------------------------------------------------------------------------------------------------------------------------------------------------------------------------------|
| 127 | R/WC/P | 0s | Core | Fault (F): Hardware sets this field to indicate a fault is logged in this Fault Recording register. The F field is set by hardware after the details of the fault is recorded in the PADDR, SID, FR and T fields. When this field is set, hardware may collapse additional faults from the same requestor (SID). Software writes the value read from this field to clear it. |
| 126 | RO/P | 0s | Core | Type (T): Type of the faulted DMA request. 0 = DMA write 1 = DMA read request This field is relevant only when the F field is set. |
| 125:124 | RO | 0s | Core | Address Type (AT): This field captures the AT field from the faulted DMA request. Hardware implementations not supporting Device- IOTLBs (DI field Clear in Extended Capability register) treat this field as Reserved. When supported, this field is valid only when the F field is Set, and when the fault reason (FR) indicates one of the DMA-remapping fault conditions. NOTE: This field is reserved as this feature is not supported. |
| 123:104 | RO | 0s | Core | Reserved |
| 103:96 | RO/P | 0s | Core | Fault Reason (FR): Reason for the fault. Appendix B enumerates the various translation fault reason encodings. This field is relevant only when the F field is set. |
| 95:80 | RO | 0s | Core | Reserved |
| 79:64 | RO/P | 0s | Core | Source Identifier (SID): Requester-ID of the faulted DMA request. This field is relevant only when the F field is set. |
| 63:12 | RO/P | 0s | Core | Fault Info (FI): This field contains the address (page-granular) in the faulted DMA request. Hardware may treat bits 63: N as reserved (0), where N is the maximum guest address width (MGAW) supported. This field is relevant only when the F field is set. |
| 11:0 | RO | 0s | Core | Reserved |

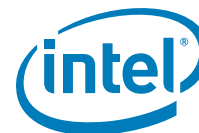

12.3 GFXVTBAR

Table 28. GFXVTBAR Register Address Map

| Address Offset | Register Symbol | Register Name | Default Value | Access |
|----------------|-----------------|--------------------------------------|------------------------------------------------|---------------------|
| 0–3h | VER_REG | Version Register | 00000010h | RO |
| 8–Fh | CAP_REG | Capability Register | 00C00000 20230272h | RO |
| 10–17h | ECAP_REG | Extended Capability Register | 000000000 0001000h | RO |
| 18–1Bh | GCMD_REG | Global Command Register | 00000000h | WO, RO |
| 1C–1Fh | GSTS_REG | Global Status Register | 00000000h | RO |
| 20–27h | RTADDR_REG | Root-Entry Table Address Register | 000000000 0000000h | RO, R/W |
| 28–2Fh | CCMD_REG | Context Command Register | 080000000 0000000h | R/W, RO, WO |
| 34–37h | FSTS_REG | Fault Status Register | 00000000h | R/WC/P, RO/P, RO |
| 38–3Bh | FECTL_REG | Fault Event Control Register | 80000000h | RO, R/W |
| 3C–3Fh | FEDATA_REG | Fault Event Data Register | 00000000h | RO, R/W |
| 40–43h | FEADDR_REG | Fault Event Address Register | 00000000h | R/W, RO |
| 44–47h | FEUADDR_REG | Fault Event Upper Address Register | 00000000h | RO |
| 58–5Fh | AFLOG_REG | Advanced Fault Log Register | 000000000 0000000h | RO |
| 64–67h | PMEN_REG | Protected Memory Enable Register | 00000000h | R/W, RO |
| 68–6Bh | PLMBASE_REG | Protected Low Memory Base Register | 00000000h | RO, R/W |
| 6C–6Fh | PLMLIMIT_REG | Protected Low Memory Limit Register | 00000000h | R/W, RO |
| 70–77h | PHMBASE_REG | Protected High Memory Base Register | 000000000 0000000h | RO, R/W |
| 78–7Fh | PHMLIMIT_REG | Protected High Memory Limit Register | 000000000 0000000h | RO, R/W |
| 100–107h | IVA_REG | Invalidate Address Register | 000000000 0000000h | WO, RO |
| 108–10Fh | IOTLB_REG | IOTLB Invalidate Register | 020000000 0000000h | R/W, RO |
| 200–20Fh | FRCD_REG | Fault Recording Registers | 000000000 000001000 000000000 000000h | RO/P, R/WC/P, RO |



12.3.1 VER_REG—Version Register

B/D/F/Type: 0/2/0/GFXVTBAR
 Address Offset: 0-3h
 Default Value: 00000010h
 Access: RO
 Size: 32 bits

This register reports the architecture version supported. Backward compatibility for the architecture is maintained with new revision numbers, allowing software to load DMA-remapping drivers written for prior architecture versions.

| Bit | Access | Default Value | RST/PWR | Description |
|------|--------|---------------|---------|-----------------------------------------------------------------------------------------------|
| 31:8 | RO | 000000h | Core | Reserved |
| 7:4 | RO | 1h | Core | Major Version number (MAX): This field indicates supported architecture version. |
| 3:0 | RO | 0h | Core | Minor Version number (MIN): This field indicates supported architecture minor version. |

12.3.2 CAP_REG—Capability Register

B/D/F/Type: 0/2/0/GFXVTBAR
 Address Offset: 8-Fh
 Default Value: 00C0000020630272h
 Access: RO
 Size: 64 bits

This register reports general translation hardware capabilities.

| Bit | Access | Default Value | RST/PWR | Description |
|-------|--------|---------------|---------|-----------------------------------------------------------------------------------------------------------------------------------------------------------------------------------------------------------------------------------------------------------------------------------------------------------|
| 63:56 | RO | 00h | Core | Reserved |
| 55 | RO | 1h | Core | DMA Read Draining (DRD): 0 = As part of IOTLB invalidations, hardware does not support draining of translated DMA read requests queued within the root complex 1 = As part of IOTLB invalidations, hardware supports draining of translated DMA read requests queued within the root complex |
| 54 | RO | 1h | Core | DMA Write Draining (DWD): 0 = On IOTLB invalidations, hardware does not support draining of translated DMA writes queued within the root complex. 0 = On IOTLB invalidations, hardware supports draining of translated DMA writes queued within the root complex. |
| 53:48 | RO | 00h | Core | Maximum Address Mask Value (MAMV): The value in this field indicates the maximum supported value for the Address Mask (AM) field in the Invalidation Address (IVA_REG) register. NOTE: This field is reserved as this feature is not supported. |



| Bit | Access | Default Value | RST/PWR | Description |
|-------|--------|---------------|---------|----------------------------------------------------------------------------------------------------------------------------------------------------------------------------------------------------------------------------------------------------------------------------------------------------------------------------------------------------------------------------------------------------------------------------------------------------------------------------------------------------------------------------------------------------------------------------|
| 47:40 | RO | 00h | Core | <p>Number of Faultrecording Registers (NFR): This field indicates a value of N-1, where N is the number of fault recording registers supported by hardware.</p> <p>Implementations must support at least one fault recording register (NFR = 0) for each DMAremapping hardware unit in the platform.</p> <p>The maximum number of fault recording registers per DMA-remapping hardware unit is 256.</p> |
| 39 | RO | 0b | Core | <p>Page-Selective Invalidation Support (PSI):</p> <p>0 = Hardware does not support page-selective IOTLB invalidations.</p> <p>1 = Hardware supports page-selective IOTLB invalidations. The MAMV field indicates the maximum number of contiguous translations that may be invalidated in a single request.</p> <p>NOTE: This field is reserved as this feature is not supported.</p> |
| 38 | RO | 0b | Core | Reserved |
| 37:34 | RO | 0h | Core | <p>Super-Page support (SPS): This field indicates the super page sizes supported by hardware.</p> <p>A value of 1 in any of these bits indicates the corresponding super-page size is supported. The super-page sizes corresponding to various bit positions within this field are:</p> <p>0 = 21-bit offset to page frame 1 = 30-bit offset to page frame 2 = 39-bit offset to page frame 3 = 48-bit offset to page frame</p> |
| 33:24 | RO | 020h | Core | <p>Fault-recording Register offset (FRO): This field specifies the location to the first fault recording register relative to the register base address of this DMA-remapping hardware unit.</p> <p>If the register base address is X, and the value reported in this field is Y, the address for the first fault recording register is calculated as $X+(16*Y)$.</p> |
| 23 | RO | 0h | Core | <p>Isochrony (ISOCH):</p> <p>0 = Remapping hardware unit has no critical isochronous requesters in its scope.</p> <p>1 = Remapping hardware unit has one or more critical isochronous requesters in its scope. To ensure isochronous performance, software must ensure invalidation operations do not impact active DMA streams from such requesters. This implies, when isochronous DMA is active, software performs page selective invalidations (and not coarser invalidations)</p> <p>NOTE: This field is reserved as this feature is not supported.</p> |



| Bit | Access | Default Value | RST/PWR | Description |
|-------|--------|---------------|---------|-----------------------------------------------------------------------------------------------------------------------------------------------------------------------------------------------------------------------------------------------------------------------------------------------------------------------------------------------------------------------------------------------------------------------------------------------------------------------------------------------------------------------------------------------------------------------------------------------------------------------------------------------------------------------------------------------------------------------------------------------------------------------------------------------------------------------------------------------------------------------------------------------------------------------------|
| 22 | RO | 1b | Core | <p>Zero Length Read (ZLR): 0 = Remapping hardware unit blocks (and treats as fault) zero length DMA read requests to write-only pages. 1 = Remapping hardware unit supports zero length DMA read requests to write-only pages.</p> |
| 21:16 | RO | 23h | Core | <p>Maximum Guest Address Width (MGAW): This field indicates the maximum DMA virtual addressability supported by remapping hardware.</p> <p>The Maximum Guest Address Width (MGAW) is computed as $(N+1)$, where N is the value reported in this field. For example, a hardware implementation supporting 48-bit MGAW reports a value of 47 (101111b) in this field.</p> <p>If the value in this field is X, DMA requests to addresses above $2(x+1)-1$ are always blocked by hardware.</p> <p>Guest addressability for a given DMA request is limited to the minimum of the value reported through this field and the adjusted guest address width of the corresponding page-table structure. (Adjusted guest address widths supported by hardware are reported through the SAGAW field).</p> |
| 15:13 | RO | 0h | Core | Reserved |
| 12:8 | RO | 02h | Core | <p>Supported adjusted guest address width (SAGAW): This 5-bit field indicates the supported adjusted guest address widths (which in turn represents the levels of page-table walks) supported by the hardware implementation.</p> <p>A value of 1 in any of these bits indicates the corresponding adjusted guest address width is supported. The adjusted guest address widths corresponding to various bit positions within this field are:</p> <ul style="list-style-type: none"> 0 = 30-bit AGAW (2-level page table) 1 = 39-bit AGAW (3-level page table) 2 = 48-bit AGAW (4-level page table) 3 = 57-bit AGAW (5-level page table) 4 = 64-bit AGAW (6-level page table) <p>Software must ensure that the adjusted guest address width used to setup the page tables is one of the supported guest address widths reported in this field.</p> |



| Bit | Access | Default Value | RST/PWR | Description |
|-----|--------|---------------|---------|---------------------------------------------------------------------------------------------------------------------------------------------------------------------------------------------------------------------------------------------------------------------------------------------------------------------------------------------------------------------------------------------------------------------------------------------------------------------------------------------------------------------------------------------------------------------------------------------------------------------------------------------------------------------------------------------------------------------------------------------|
| 7 | RO | 0h | Core | <p>Caching Mode (CM):</p> <p>0 = Hardware does not cache not present and erroneous entries in the context-cache and IOTLB. Invalidations are not required for modifications to individual not present or invalid entries. However, any modifications that result in decreasing the effective permissions or partial permission increases require invalidations for them to be effective.</p> <p>1 = Hardware may cache not present and erroneous mappings in the context-cache or IOTLB. Any software updates to the DMA-remapping structures (including updates to not-present or erroneous entries) require explicit invalidation.</p> <p>Hardware implementations are recommended to support operation corresponding to CM=0.</p> |
| 6 | RO | 1h | Core | <p>Protected High-Memory Region (PHMR):</p> <p>0 = Protected high-memory region not supported.</p> <p>1 = Protected high-memory region is supported.</p> <p>DMA-remapping hardware implementations on Intel TXT platforms supporting main memory above 4 GB are required to support protected high-memory region.</p> |
| 5 | RO | 1h | Core | <p>Protected Low-Memory Region (PLMR):</p> <p>0 = Protected low-memory region not supported.</p> <p>1 = Protected low-memory region is supported.</p> <p>DMA-remapping hardware implementations on Intel TXT platforms are required to support protected low-memory region.</p> |
| 4 | RO | 1h | Core | <p>Required Write-Buffer Flushing (RWBF):</p> <p>0 = No write-buffer flushing needed to ensure changes to memory-resident structures are visible to hardware.</p> <p>1 = Software must explicitly flush the write buffers (through the Global Command register) to ensure updates made to memory-resident DMA-remapping structures are visible to hardware.</p> |
| 3 | RO | 0h | Core | <p>Advanced Fault Logging (AFL):</p> <p>0 = Advanced fault logging through memory-resident fault log not supported. Only primary fault logging is supported.</p> <p>1 = Advanced fault logging is supported.</p> |



| Bit | Access | Default Value | RST/PWR | Description |
|-----|--------|---------------|---------|--------------------------------------------------------------------------------------------------------------------------------------------------------------------------------------------------------------------------------------------------------------------------------------------------------------------------------------------------------------------------------------------------------------------------------------------------------------------------------------------------------------------------------------------------------------------------------------------------------------------------------------------------------------------------------------|
| 2:0 | RO | 2h | Core | <p>Number of domains supported (ND):</p> <p>000 = Hardware supports 4-bit domain-IDs with support for up to 16 domains.</p> <p>001 = Hardware supports 6-bit domain-IDs with support for up to 64 domains.</p> <p>010 = Hardware supports 8-bit domain-IDs with support for up to 256 domains.</p> <p>011 = Hardware supports 10-bit domain-IDs with support for up to 1024 domains.</p> <p>100 = Hardware supports 12-bit domain-IDs with support for up to 4K domains.</p> <p>100 = Hardware supports 14-bit domain-IDs with support for up to 16K domains.</p> <p>110 = Hardware supports 16-bit domain-IDs with support for up to 64K domains.</p> <p>111 = Reserved.</p> |

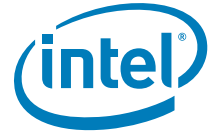

12.3.3 ECAP_REG—Extended Capability Register

B/D/F/Type: 0/2/0/GFXVTBAR
 Address Offset: 10-17h
 Default Value: 0000000000001000h
 Access: RO
 Size: 64 bits

the register reports DMA-remapping hardware extended capabilities.

| Bit | Access | Default Value | RST/PWR | Description |
|-------|--------|---------------|---------|--------------------------------------------------------------------------------------------------------------------------------------------------------------------------------------------------------------------------------------------------------------------------------------------------------------------------------------------------------------------------------------------------------------------------------------------------------------------------------------------------------------------------------------------|
| 63:24 | RO | 00000000h | Core | Reserved |
| 23:20 | RO | 0h | Core | <p>Maximum Handle Mask Value (MHMV): The value in this field indicates the maximum supported value for the Handle Mask (HM) field in the interrupt entry cache invalidation descriptor (<i>iec_inv_dsc</i>). This field is valid only when the IR field is reported as Set.</p> <p>NOTE: This field is reserved as this feature is not supported.</p> |
| 19:18 | RO | 00b | Core | Reserved |
| 17:8 | RO | 010h | Core | <p>Invalidation Unit Offset (IVO): This field specifies the location to the first IOTLB invalidation unit relative to the register base address of this DMA-remapping hardware unit.</p> <p>If the register base address is X, and the value reported in this field is Y, the address for the first IOTLB invalidation unit is calculated as $X + (16 * Y)$.</p> <p>If N is the value reported in NIU field, the address for the last IOTLB invalidation unit is calculated as $X + (16 * Y) + (16 * N)$.</p> |
| 7 | RO | 0b | Core | <p>Snoop Control (SC):</p> <p>0 = Hardware does not support 1-setting of the SNP field in the page-table entries.</p> <p>1 = Hardware supports the 1-setting of the SNP field in the page-table entries.</p> <p>NOTE: This field is reserved as this feature is not supported.</p> |
| 6 | RO | 0b | Core | <p>Pass Through (PT):</p> <p>0 = Hardware does not support pass through translation type in context entries.</p> <p>1 = Hardware supports pass-through translation type in context entries.</p> <p>NOTE: This field is reserved as this feature is not supported.</p> |



| Bit | Access | Default Value | RST/PWR | Description |
|-----|--------|---------------|---------|-------------------------------------------------------------------------------------------------------------------------------------------------------------------------------------------------------------------------------------------------------------------------------------------------------------------------------------------------------------------------------------------------------------------------------------------------------------|
| 5 | RO | 0b | Core | <p>Caching Hints (CH): 0 = Hardware does not support IOTLB caching hints (ALH and EH fields in context-entries are treated as reserved). 1 = Hardware supports IOTLB caching hints through the ALH and EH fields in context-entries.</p> <p>NOTE: This field is reserved as this feature is not supported.</p> |
| 4 | RO | 0b | Core | <p>Extended Interrupt Mode (EIM): 0 = Hardware supports only 8-bit APICIDs (Legacy Interrupt Mode) on Intel® 64 and IA-32 platforms and 16-bit APIC-IDs on Itanium™ platforms. 1 = Hardware supports Extended Interrupt Mode (32-bit APIC-IDs) on Intel® 64 platforms. This field is valid only when the IR field is reported as Set.</p> <p>NOTE: This field is reserved as this feature is not supported.</p> |
| 3 | RO | 0b | Core | <p>Interrupt Remapping Support (IR): 0 = Hardware does not support interrupt remapping. 1 = Hardware supports interrupt remapping. Implementations reporting this field as Set must also support Queued Invalidation (QI = 1b).</p> <p>NOTE: This field is reserved as this feature is not supported.</p> |
| 2 | RO | 0b | Core | <p>Device IOTLB Support (DI): 0 = Hardware does not support device-IOTLBs. 1 = Hardware supports Device-IOTLBs. Implementations reporting this field as Set must also support Queued Invalidation (QI = 1b).</p> <p>NOTE: This field is reserved as this feature is not supported.</p> |
| 1 | RO | 0b | Core | <p>Queued Invalidation Support (QI): 0 = Hardware does not support queued invalidations. 1 = Hardware supports queued invalidations.</p> <p>NOTE: This field is reserved as this feature is not supported.</p> |
| 0 | RO | 0b | Core | <p>Coherency (C): 0 = Indicates hardware accesses to root, context and page-table structures are not coherent (non-snooped). 1 = Indicates hardware accesses to root, context and page-table structures are coherent (snooped). Hardware writes to the advanced fault log is required to be coherent.</p> |

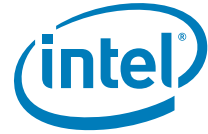

12.3.4 GCMD_REG—Global Command Register

B/D/F/Type: 0/2/0/GFXVTBAR
 Address Offset: 18-1Bh
 Default Value: 00000000h
 Access: WO, RO
 Size: 32 bits

This register is used to control DMA-remapping hardware. If multiple control fields in this register need to be modified, software must serialize through multiple accesses to this register.

| Bit | Access | Default Value | RST/PWR | Description |
|-----|--------|---------------|---------|--------------------------------------------------------------------------------------------------------------------------------------------------------------------------------------------------------------------------------------------------------------------------------------------------------------------------------------------------------------------------------------------------------------------------------------------------------------------------------------------------------------------------------------------------------------------------------------------------------------------------------------------------------------------------------------------------------------------------------------------------------------------------------------------------------------------------------------------------------------------------------------------------------------------------------------------------------------------------------------------------------------------------------------------------------------------------------------------------------------------------------------------------------------------------------------------------------------------------------------------------------------------------------------------------------------------------------------------------------------------------------------------------------------------------------------------------------------------------------------------------------------------------------------------------------------------------------------------------------------------------------|
| 31 | WO | 0 | Core | <p>Translation Enable (TE): Software writes to this field to request hardware to enable/disable DMA-remapping hardware.</p> <p>0 = Disable DMA-remapping hardware 1 = Enable DMA-remapping hardware</p> <p>Hardware reports the status of the translation enable operation through the TES field in the Global Status register.</p> <p>Before enabling (or re-enabling) DMA-remapping hardware through this field, software must:</p> <ul style="list-style-type: none"> • Setup the DMA-remapping structures in memory • Flush the write buffers (through WBF field), if write buffer flushing is reported as required. • Set the root-entry table pointer in hardware (through SRTP field). • Perform global invalidation of the context-cache and global invalidation of IOTLB • If advanced fault logging supported, setup fault log pointer (through SFL field) and enable advanced fault logging (through EAFL field). <p>There may be active DMA requests in the platform when software updates this field. Hardware must enable or disable remapping logic only at deterministic transaction boundaries, so that any in-flight transaction is either subject to remapping or not at all.</p> <p>Hardware implementations supporting DMA draining must drain any in-flight translated DMA read/write requests queued within the root complex before completing the translation enable command and reflecting the status of the command through the TES field in the GSTS_REG. Value returned on read of this field is undefined.</p> |

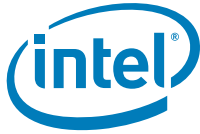

| Bit | Access | Default Value | RST/PWR | Description |
|-----|--------|---------------|---------|------------------------------------------------------------------------------------------------------------------------------------------------------------------------------------------------------------------------------------------------------------------------------------------------------------------------------------------------------------------------------------------------------------------------------------------------------------------------------------------------------------------------------------------------------------------------------------------------------------------------------------------------------------------------------------------------------------------------------------------------------------------------------------------------------------------------------------------------------------------------------------------------------------------------------------------------------------------------------------------------------------------------------------------------------------------------------------------------------------------------------------------------------------------------------------------------------------------------------------------------------------------------------------------------------|
| 30 | WO | 0 | Core | <p>Set Root Table Pointer (SRTP): Software sets this field to set/update the root-entry table pointer used by hardware. The root-entry table pointer is specified through the Root-entry Table Address register.</p> <p>Hardware reports the status of the root table pointer set operation through the RTPS field in the Global Status register.</p> <p>The root table pointer set operation must be performed before enabling or re-enabling (after disabling) DMA-remapping hardware.</p> <p>After a root table pointer set operation, software must globally invalidate the context cache followed by global invalidate of IOTLB. This is required to ensure hardware uses only the remapping structures referenced by the new root table pointer, and not any stale cached entries.</p> <p>While DMA-remapping hardware is active, software may update the root table pointer through this field. However, to ensure valid in-flight DMA requests are deterministically remapped, software must ensure that the structures referenced by the new root table pointer are programmed to provide the same remapping results as the structures referenced by the previous root table pointer.</p> <p>Clearing this bit has no effect. Value returned on read of this field is undefined.</p> |
| 29 | RO | 0 | Core | <p>Set Fault Log (SFL): This field is valid only in implementations supporting advanced fault logging. If advanced fault logging is not supported, writes to this field are ignored.</p> <p>Software sets this field to request hardware to set/update the fault-log pointer used by hardware. The fault-log pointer is specified through Advanced Fault Log register.</p> <p>Hardware reports the status of the fault log set operation through the FLS field in the Global Status register. The fault log pointer must be set before enabling advanced fault logging (through EAFL field). Once advanced fault logging is enabled, the fault log pointer may be updated through this field while DMA-remapping hardware is active.</p> <p>Clearing this bit has no effect. Value returned on read of this field is undefined.</p> |



| Bit | Access | Default Value | RST/PWR | Description |
|-----|--------|---------------|---------|-------------------------------------------------------------------------------------------------------------------------------------------------------------------------------------------------------------------------------------------------------------------------------------------------------------------------------------------------------------------------------------------------------------------------------------------------------------------------------------------------------------------------------------------------------------------------------------------------------------------------------------------------------------------------------------------------------------------------------------------------------------------------------------------------------------------------------------------------------------------------------------------------------|
| 28 | RO | 0 | Core | <p>Enable Advanced Fault Logging (EAFL): This field is valid only in implementations supporting advanced fault logging. If advanced fault logging is not supported, writes to this field are ignored.</p> <p>Software writes to this field to request hardware to enable or disable advanced fault logging.</p> <p>0 = Disable advanced fault logging. In this case, translation faults are reported through the Fault Recording registers.</p> <p>1 = Enable use of memory-resident 4 KB fault log. When enabled, translation faults are recorded in the memory-resident log. The fault log pointer must be set in hardware (through SFL field) before enabling advanced fault logging.</p> <p>Hardware reports the status of the advanced fault logging enable operation through the AFLS field in the Global Status register.</p> <p>Value returned on read of this field is undefined.</p> |
| 27 | WO | 0 | Core | <p>Write Buffer Flush (WBF): This bit is valid only in implementations requiring write buffer flushing. If write buffer flushing is not required, writes to this field are ignored.</p> <p>Software sets this field to request hardware to flush the root-complex internal write buffers. This is done to ensure any updates to the memory-resident DMA-remap structures are not held in any internal write posting buffers.</p> <p>Hardware reports the status of the write buffer flushing operation through the WBFS field in the Global Status register.</p> <p>Clearing this bit has no effect. Value returned on read of this field is undefined.</p> |
| 26 | RO | 0b | Core | <p>Queued Invalidation Enable (QIE): This field is valid only for implementations supporting queued invalidations. Software writes to this field to enable or disable queued invalidations.</p> <p>0 = Disable queued invalidations.</p> <p>1 = Enable use of queued invalidations.</p> <p>Hardware reports the status of queued invalidation enable operation through QIES field in the Global Status register. The value returned on a read of this field is undefined.</p> <p>NOTE: This field is reserved as this feature is not supported.</p> |

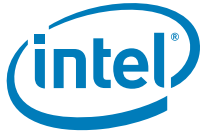

| Bit | Access | Default Value | RST/PWR | Description |
|-----|--------|---------------|---------|-----------------------------------------------------------------------------------------------------------------------------------------------------------------------------------------------------------------------------------------------------------------------------------------------------------------------------------------------------------------------------------------------------------------------------------------------------------------------------------------------------------------------------------------------------------------------------------------------------------------------------------------------------------------------------------------------------------------------------------------------------------------------------------------------------------------------------------------------------------------------------------------------------------------------------------------------------------------------------------------------------------------------------------------------------------------------------------------------------------------------------------------------------------------------------------------------------------------------------------------------------------------------------------------------------------------------------------------------------------------------------------------------------------------------------------------------------------------------------------------------------------------------------------------------------------------------------------------------------------------------------------------------------------------|
| 25 | RO | 0b | Core | <p>Interrupt Remapping Enable (IRE): This field is valid only for implementations supporting interrupt remapping. 0 = Disable interrupt-remapping hardware 1 = Enable interrupt-remapping hardware Hardware reports the status of the interrupt remapping enable operation through the IRES field in the Global Status register. There may be active interrupt requests in the platform when software updates this field. Hardware must enable or disable interrupt-remapping logic only at deterministic transaction boundaries, so that any in-flight interrupts are either subject to remapping or not at all. Hardware implementations must drain any in-flight interrupts requests queued in the Root-Complex before completing the interrupt-remapping enable command and reflecting the status of the command through the IRES field in the Global Status register. The value returned on a read of this field is undefined.</p> <p>NOTE: This field is reserved as this feature is not supported.</p> |
| 24 | RO | 0b | Core | <p>Set Interrupt Remap Table Pointer (SIRTP): This field is valid only for implementations supporting interrupt-remapping. Software sets this field to set/update the interrupt remapping table pointer used by hardware. The interrupt remapping table pointer is specified through the Interrupt Remapping Table Address register. Hardware reports the status of the interrupt remapping table pointer set operation through the IRTPS field in the Global Status register. The interrupt remap table pointer set operation must be performed before enabling or re-enabling (after disabling) interrupt-remapping hardware through the IRE field. After an interrupt remap table pointer set operation, software must globally invalidate the interrupt entry cache. This is required to ensure hardware uses only the interrupt-remapping entries referenced by the new interrupt remap table pointer, and not any stale cached entries. While interrupt remapping is active, software may update the interrupt remapping table pointer through this field. However, to ensure valid in-flight interrupt requests are deterministically remapped, software must ensure that the structures referenced by the ew interrupt remap table pointer are programmed to provide the same remapping results as the structures referenced by the previous interrupt remap table pointer. Clearing this bit has no effect. The value returned on a read of this field is undefined.</p> <p>NOTE: This field is reserved as this feature is not supported.</p> |

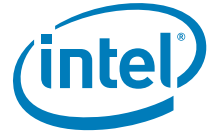

| Bit | Access | Default Value | RST/PWR | Description |
|------|--------|---------------|---------|----------------------------------------------------------------------------------------------------------------------------------------------------------------------------------------------------------------------------------------------------------------------------------------------------------------------------------------------------------------------------------------------------------------------------------------------------------------------------------------------------------------------------------------------------------------------------------------------------------------------------------------------------------------------------------------------------------------------------------------------------------------------------------------------------------------------------------------------------------------------------|
| 23 | RO | 0b | Core | <p>Compatibility Format Interrupt (CFI): This field is valid only for Intel 64 implementations supporting interrupt-remapping.</p> <p>Software writes to this field to enable or disable Compatibility Format interrupts on Intel® 64 architecture platforms. The value in this field is effective only when interrupt-remapping is enabled and Legacy Interrupt Mode is active.</p> <p>0 = Block Compatibility format interrupts. 1 = Process Compatibility format interrupts as pass-through (bypass interrupt remapping).</p> <p>Hardware reports the status of updating this field through the CFIS field in the Global Status register.</p> <p>The value returned on a read of this field is undefined.</p> <p>This field is not implemented on Itanium™ implementations.</p> <p>NOTE: This field is reserved as this feature is not supported.</p> |
| 22:0 | RO | 0s | Core | Reserved |



12.3.5 GSTS_REG—Global Status Register

B/D/F/Type: 0/2/0/GFXVTBAR
 Address Offset: 1C-1Fh
 Default Value: 00000000h
 Access: RO
 Size: 32 bits

This register reports general DMA-remapping hardware status.

| Bit | Access | Default Value | RST/PWR | Description |
|-----|--------|---------------|---------|------------------------------------------------------------------------------------------------------------------------------------------------------------------------------------------------------------------------------------------------------------------------------------------------------------------------------------------------------------------------------------------------------------------------------------------------------------------------------------------------------------------------------|
| 31 | RO | 0 | Core | Translation Enable Status (TES): This field indicates the status of DMA-remapping hardware. 0 = DMA-remapping hardware is not enabled 1 = DMA-remapping hardware is enabled |
| 30 | RO | 0 | Core | Root Table Pointer Status (RTPS): This field indicates the status of the root- table pointer in hardware. This field is cleared by hardware when software sets the SRTP field in the Global Command register. This field is set by hardware when hardware finishes the set root-table pointer operation (by performing an implicit global invalidation of the context-cache and IOTLB, and setting/ updating the root-table pointer in hardware with the value provided in the Root-Entry Table Address register). |
| 29 | RO | 0 | Core | Fault Log Status (FLS): This field is valid only in implementations supporting advanced fault logging. This field indicates the status of the fault-log pointer in hardware. This field is cleared by hardware when software sets the SFL field in the Global Command register. This field is set by hardware when hardware finishes the set fault-log pointer operation (by setting/ updating the faultlog pointer in hardware with the value provided in the Advanced Fault Log register). |
| 28 | RO | 0 | Core | Advanced Fault Logging Status (AFLS): This field is valid only for implementations supporting advanced fault logging. This field indicates advanced fault logging status. 0 = Advanced Fault Logging is not enabled 1 = Advanced Fault Logging is enabled |
| 27 | RO | 0 | Core | Write Buffer Flush Status (WBFS): This bit is valid only in implementations requiring write buffer flushing. This field indicates the status of the write buffer flush operation. This field is set by hardware when software sets the WBF field in the Global Command register. This field is cleared by hardware when hardware finishes the write buffer flush operation. |
| 26 | RO | 0 | Core | Queued Invalidation Enable Status (QIES): This field indicates queued invalidation enable status. 0 = queued invalidation is not enabled 1 = queued invalidation is enabled |



| Bit | Access | Default Value | RST/PWR | Description |
|------|--------|---------------|---------|------------------------------------------------------------------------------------------------------------------------------------------------------------------------------------------------------------------------------------------------------------------------------------------------------------------------------------------------------------------------------------------------------------------------------------------------------------------------------------------|
| 25 | RO | 0b | Core | Interrupt Remapping Enable Status (IRES): This field indicates the status of Interrupt-remapping hardware. 0 = Interrupt-remapping hardware is not enabled 1 = Interrupt-remapping hardware is enabled |
| 24 | RO | 0b | Core | Interrupt Root Table Pointer Status (IRTPS): This field indicates the status of the interrupt remapping table pointer in hardware. This field is cleared by hardware when software sets the SIRTTP field in the Global Command register. This field is Set by hardware when hardware completes the set interrupt remap table pointer operation using the value provided in the Interrupt Remapping Table Address register. |
| 23 | RO | 0b | Core | Compatibility Format Interrupt Status (CFIS): This field indicates the status of Compatibility format interrupts on Intel® 64 architecture implementations supporting interrupt-remapping. The value reported in this field is applicable only when interrupt-remapping is enabled and Legacy interrupt mode is active. 0 = Compatibility format interrupts are blocked. 1 = Compatibility format interrupts are processed as pass-through (bypassing interrupt remapping). |
| 22:0 | RO | 0s | Core | Reserved |

12.3.6 RTADDR_REG—Root-Entry Table Address Register

B/D/F/Type: 0/2/0/GFXVTBAR
 Address Offset: 20-27h
 Default Value: 0000000000000000h
 Access: RO, R/W
 Size: 64 bits

This register is used to setup location of root-entry table.

| Bit | Access | Default Value | RST/PWR | Description |
|-------|--------|---------------|---------|--------------------------------------------------------------------------------------------------------------------------------------------------------------------------------------------------------------------------------------------------------------------------------------------------------------------------------------------------------------------------------------------------------------------------------------------------|
| 63:36 | RO | 0s | Core | RTA63:HAW (RTA_R): Made Read Only as hardware ignores bits 63:HAW. |
| 35:12 | R/W | 0s | Core | Root table address (RTA): This register points to base of page aligned, 4 KB-sized root-entry table in system memory. Hardware ignores bits 63:HAW, where HAW is the host address width. Software specifies the base address of the root-entry table through this register, and programs it in hardware through the SRTP field in the Global Command register. Reads of this register returns value that was last programmed to it. |
| 11:0 | RO | 0s | Core | Reserved |

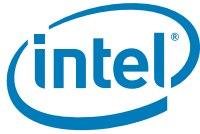

12.3.7 CCMD_REG—Context Command Register

B/D/F/Type: 0/2/0/GFXVTBAR
 Address Offset: 28-2Fh
 Default Value: 0800000000000000h
 Access: R/W, RO, WO
 Size: 64 bits

This register is used to manage context-entry cache. The act of writing the uppermost byte of the CCMD_REG with ICC field set causes the hardware to perform the context-cache invalidation.

| Bit | Access | Default Value | RST/PWR | Description |
|-------|--------|---------------|---------|-----------------------------------------------------------------------------------------------------------------------------------------------------------------------------------------------------------------------------------------------------------------------------------------------------------------------------------------------------------------------------------------------------------------------------------------------------------------------------------------------------------------------------------------------------------------------------------------------------------------------------------------------------------------------------------------------------------------------------------------------------------------------------------------------------------------------------------------------------------------------------------------------------------------------------------------------------------------------------------------------------------------------------------------------------------------------------------------------------------------------------------------------------------------------------------------------------------------------------------------------------------------------------------------------------------------------------------------------|
| 63 | R/W | 0 | Core | <p>Invalidate Context-entry Cache (ICC): Software requests invalidation of context-cache by setting this field. Software must also set the requested invalidation granularity by programming the CIRG field. Software must read back and check the ICC field to be clear to confirm the invalidation is complete. Software must not update this register when this field is set. Hardware clears the ICC field to indicate the invalidation request is complete. Hardware also indicates the granularity at which the invalidation operation was performed through the CAIG field. Software must not submit another invalidation request through this register while the ICC field is set.</p> <p>Software must submit a context cache invalidation request through this field only when there are no invalidation requests pending at this DMA-remapping hardware unit. Since information from the context-cache may be used by hardware to tag IOTLB entries, software must perform domain-selective (or global) invalidation of IOTLB after the context cache invalidation has completed.</p> <p>Hardware implementations reporting write-buffer flushing requirement (RWBF=1 in Capability register) must implicitly perform a write buffer flushing before reporting invalidation complete to software through the ICC field.</p> |
| 62:61 | R/W | 00b | Core | <p>Context-cache Invalidation Request Granularity (CIRG): Software provides the requested invalidation granularity through this field when setting the ICC field.</p> <p>00 = Reserved. 01 = Global Invalidation request. 10 = Domain-selective invalidation request. The target domain-ID must be specified in the DID field. 11 = Device-selective invalidation request. The target source-ID(s) must be specified through the SID and FM fields, and the domain-ID (that was programmed in the context-entry for these device(s)) must be provided in the DID field.</p> <p>Hardware implementations may process an invalidation request by performing invalidation at a coarser granularity than requested. Hardware indicates completion of the invalidation request by clearing the ICC field. At this time, hardware also indicates the granularity at which the actual invalidation was performed through the CAIG field.</p> |



| Bit | Access | Default Value | RST/PWR | Description |
|-------|--------|---------------|---------|-----------------------------------------------------------------------------------------------------------------------------------------------------------------------------------------------------------------------------------------------------------------------------------------------------------------------------------------------------------------------------------------------------------------------------------------------------------------------------------------------------------------------------------------------------------------------------------------------------------------------------------------------------------------------------------------------------------------------------------------------------------------------------------------------------------------------------------------------------------------------------------|
| 60:59 | RO | 11b | Core | <p>Context-cache Actual Invalidation Granularity (CAIG): Hardware reports the granularity at which an invalidation request was processed through the CAIG field at the time of reporting invalidation completion (by clearing the ICC field).</p> <p>00 = Reserved. This is the value on reset.</p> <p>01 = Global Invalidation performed. This could be in response to a global, domain-selective or device-selective invalidation request.</p> <p>10 = Domain-selective invalidation performed using the domain-ID specified by software in the DID field. This could be in response to a domain-selective or device-selective invalidation request.</p> <p>11 = Device-selective invalidation performed using the source-ID and domain-ID specified by software in the SID and DID fields. This can only be in response to a device-selective invalidation request.</p> |
| 58:34 | RO | 0s | Core | Reserved |
| 33:32 | WO | 00b | Core | <p>Function Mask (FM): This field specifies which bits of the function number portion (least significant three bits) of the SID field to mask when performing device-selective invalidations.</p> <p>00 = No bits in the SID field masked.</p> <p>01 = Mask most significant bit of function number in the SID field.</p> <p>10 = Mask two most significant bit of function number in the SID field.</p> <p>11 = Mask all three bits of function number in the SID field. The SIDs specified through the FM and SID mask fields must correspond to the domain-ID specified in the DID field.</p> <p>Value returned on read of this field is undefined.</p> |
| 31:16 | WO | 0s | Core | <p>Source-ID (SID): This field indicates the source-ID of the device whose corresponding context-entry needs to be selectively invalidated. This field, along with the FM field, must be programmed by software for device-selective invalidation requests.</p> <p>Value returned on read of this field is undefined.</p> |
| 15:0 | R/W | 0s | Core | <p>Domain-ID (DID): This field indicates the ID of the domain whose context-entries needs to be selectively invalidated. This field must be programmed by software for both domain-selective and device-selective invalidation requests.</p> <p>The Capability register reports the domain-ID width supported by hardware. Software must ensure that the value written to this field is within this limit.</p> <p>Hardware may ignore and not implement bits 15:N where N is the supported domain-ID width reported in the capability register.</p> |

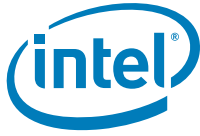

12.3.8 FSTS_REG—Fault Status Register

B/D/F/Type: 0/2/0/GFXVTBAR
 Address Offset: 34-37h
 Default Value: 00000000h
 Access: RO, R/WC/P, RO/P
 Size: 32 bits

This register indicates the primary fault logging status.

| Bit | Access | Default Value | RST/PWR | Description |
|-------|--------|---------------|---------|-----------------------------------------------------------------------------------------------------------------------------------------------------------------------------------------------------------------------------------------------------------------------------------------------------------------------------------------------------------------------------------------------------------------------------------------------------------------------------------------------------------------------------------|
| 31:16 | RO | 0s | Core | Reserved |
| 15:8 | RO/P | 0s | Core | <p>Fault Record Index (FRI): This field is valid only when the PPF field is set.</p> <p>The FRI field indicates the index (from base) of the fault recording register to which the first pending fault was recorded when the PPF field was set by hardware.</p> <p>Valid values for this field are from 0 to N, where N is the value reported through NFR field in the Capability register.</p> <p>The value read from this field is undefined when the PPF field is clear.</p> |
| 7 | RO | 0b | Core | Reserved |
| 6 | RO | 0b | Core | <p>Invalidation Time-out Error (ITE): Hardware detected a Device-IOTLB invalidation completion time-out. At this time, a fault event may be generated based on the programming of the Fault Event Control register.</p> <p>Hardware implementations not supporting Device-IOTLBs implement this bit as Reserved.</p> <p>NOTE: This field is reserved as this feature is not supported.</p> |
| 5 | RO | 0b | Core | <p>Invalidation Completion Error (ICE): Hardware received an unexpected or invalid Device-IOTLB invalidation completion. This could be due to either an invalid ITag or invalid source-ID in an invalidation completion response. At this time, a fault event may be generated based on the programming of the Fault Event Control register.</p> <p>Hardware implementations not supporting Device-IOTLBs implement this bit as Reserved.</p> <p>NOTE: This field is reserved as this feature is not supported.</p> |



| Bit | Access | Default Value | RST/PWR | Description |
|-----|--------|---------------|---------|-----------------------------------------------------------------------------------------------------------------------------------------------------------------------------------------------------------------------------------------------------------------------------------------------------------------------------------------------------------------------------------------------------------------------------------------------------------------------------------------------------------------------------------------------------------------------------------------------------------------------------------------------------|
| 4 | RO | 0b | Core | <p>Invalidation Queue Error (IQE): Hardware detected an error associated with the invalidation queue. This could be due to either a hardware error while fetching a descriptor from the invalidation queue, or hardware detecting an erroneous or invalid descriptor in the invalidation queue. At this time, a fault event may be generated based on the programming of the Fault Event Control register. Hardware implementations not supporting queued invalidations implement this bit as Reserved.</p> <p>NOTE: This field is reserved as this feature is not supported.</p> |
| 3 | RO | 0b | Core | <p>Advanced Pending Fault (APF): When this field is Clear, hardware sets this field when the first fault record (at index 0) is written to a fault log. At this time, a fault event is generated based on the programming of the Fault Event Control register. Software writing 1 to this field clears it. Hardware implementations not supporting advanced fault logging implement this bit as Reserved.</p> <p>NOTE: This field is reserved as this feature is not supported.</p> |
| 2 | RO | 0b | Core | <p>Advanced Fault Overflow (AFO): Hardware sets this field to indicate advanced fault log overflow condition. At this time, a fault event is generated based on the programming of the Fault Event Control register. Software writing 1 to this field clears it. Hardware implementations not supporting advanced fault logging implement this bit as Reserved.</p> <p>NOTE: This field is reserved as this feature is not supported.</p> |
| 1 | RO/P | 0b | Core | <p>Primary Pending Fault (PPF): This field indicates if there are one or more pending faults logged in the fault recording registers. Hardware computes this field as the logical OR of Fault (F) fields across all the fault recording registers of this DMA-remap hardware unit.</p> <p>0 = No pending faults in any of the fault recording registers</p> <p>1 = One or more fault recording registers has pending faults. The FRI field is updated by hardware whenever the PPF field is set by hardware. Also, depending on the programming of fault event control register, a fault event is generated when hardware sets this bit.</p> |
| 0 | R/WC/P | 0b | Core | <p>Primary Fault Overflow (PFO): Hardware sets this bit to indicate overflow of fault recording registers. Software writing 1 clears this field.</p> |



12.3.9 FECTL_REG—Fault Event Control Register

B/D/F/Type: 0/2/0/GFXVTBAR
 Address Offset: 38-3Bh
 Default Value: 80000000h
 Access: RO, R/W
 Size: 32 bits

This register specifies the fault event interrupt message control bits.

| Bit | Access | Default Value | RST/PWR | Description |
|------|--------|---------------|---------|---------------------------------------------------------------------------------------------------------------------------------------------------------------------------------------------------------------------------------------------------------------------------------------------------------------------------------------------------------------------------------------------------------------------------------------------------------------------------------------------------------------------------------------------------------------------------------------------------------------------------------------------------------------------------------------------------------------------------------------------------------------------------------------------------------------------------------------------------------------------------------------------------------------------------------------------------------------------------------------------------------------------------------------------------------------------------------------------------------------------------------------------------------------------------------------------------------------------------------------------------------------------------------------------------------------------------------------------------------------------------------------------------------------------------------------------------------------------------------------------------------------------------------------------------------------------------------------------------------------------------------------------------------------------------------------------------------------------------------------------------------------------------------------------------------------------------------------------------------------------------------------------------------------------------------------------------------------------------------------------------|
| 31 | R/W | 1 | Core | <p>Interrupt-message mask (IM):</p> <p>0 = No masking of interrupt. When a interrupt condition is detected, hardware issues an interrupt message (using the Fault Event Data & Fault Event Address register values).</p> <p>1 = This is the value on reset. Software may mask interrupt message generation by setting this field. Hardware is prohibited from sending the interrupt message when this field is set.</p> |
| 30 | RO | 0 | Core | <p>Interrupt-message Pending (IP): Hardware sets the IP bit whenever it detects an interrupt condition. Interrupt condition is defined as:</p> <ul style="list-style-type: none"> When primary fault logging is active, an interrupt condition occurs when hardware records a fault through one of the Fault Recording registers and sets the PPF field in Fault Status register. If the PPF field was already set at the time of recording a fault, it is not treated as a new interrupt condition. When advanced fault logging is active, an interrupt condition occurs when hardware records a fault in the first fault record (at index 0) of the current fault log and sets the APF field in the Advanced Fault Log register. If the APF field was already set at the time of detecting/recording a fault, it is not treated as a new interrupt condition. <p>The IP field is kept set by hardware while the interrupt message is held pending. The interrupt message could be held pending due to interrupt mask (IM field) being set, or due to other transient hardware conditions.</p> <p>The IP field is cleared by hardware as soon as the interrupt message pending condition is serviced. This could be due to either:</p> <ul style="list-style-type: none"> Hardware issuing the interrupt message due to either change in the transient hardware condition that caused interrupt message to be held pending or due to software clearing the IM field. Software servicing the interrupting condition through one of the following ways: <ul style="list-style-type: none"> When primary fault logging is active, software clearing the Fault (F) field in all the Fault Recording registers with faults, causing the PPF field in Fault Status register to be evaluated as clear. When advanced fault logging is active, software clearing the APF field in Advanced Fault Log register. |
| 29:0 | RO | 0s | Core | Reserved |

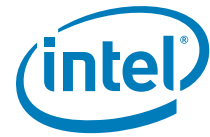

12.3.10 FEDATA_REG—Fault Event Data Register

B/D/F/Type: 0/2/0/GFXVTBAR
 Address Offset: 3C-3Fh
 Default Value: 00000000h
 Access: RO, R/W
 Size: 32 bits

This register specifies the interrupt message data.

| Bit | Access | Default Value | RST/PWR | Description |
|-------|--------|---------------|---------|----------------------------------------------------------------------------------------------------------------------------------------------------------------------------------------------------------------------------|
| 31:16 | RO | 0000h | Core | Extended Interrupt Message Data (EID): This field is valid only for implementations supporting 32-bit MSI data fields. Hardware implementations supporting only 16-bit MSI data treats this field as read only (0). |
| 15:0 | R/W | 0000h | Core | Interrupt message data (ID): Data value in the fault-event interrupt message. |

12.3.11 FEADDR_REG—Fault Event Address Register

B/D/F/Type: 0/2/0/GFXVTBAR
 Address Offset: 40-43h
 Default Value: 00000000h
 Access: R/W, RO
 Size: 32 bits

This register specifies the interrupt message address.

| Bit | Access | Default Value | RST/PWR | Description |
|------|--------|---------------|---------|-------------------------------------------------------------------------------------------------------------------------------------------------------------------------------|
| 31:2 | R/W | 00000000h | Core | Message address (MA): When fault events are enabled, the contents of this register specify the DWord aligned address (bits 31:2) for the MSI memory write transaction. |
| 1:0 | RO | 0h | Core | Reserved |



12.3.12 FEUADDR_REG—Fault Event Upper Address Register

B/D/F/Type: 0/2/0/GFXVTBAR
 Address Offset: 44-47h
 Default Value: 00000000h
 Access: RO
 Size: 32 bits

This register specifies the interrupt message address. For platforms supporting only interrupt messages in the 32-bit address range, this register is treated as read-only (0).

| Bit | Access | Default Value | RST/PWR | Description |
|------|--------|---------------|---------|-------------------------------------------------------------------------------------------------------------------------------------------------------------------------------------------------------------------------------------------------------------------------------------------------------------------------------|
| 31:0 | RO | 00000000h | Core | Message upper address (MUA): This register need to be implemented only if hardware supports 64-bit message address. If implemented, the contents of this register specify the upper 32-bits of a 64-bit MSI write transaction. If hardware does not support 64-bit messages, the register is treated as read only (0). |

12.3.13 AFLOG_REG—Advanced Fault Log Register

B/D/F/Type: 0/2/0/GFXVTBAR
 Address Offset: 58-5Fh
 Default Value: 0000000000000000h
 Access: RO
 Size: 64 bits

This register specifies the base address of memory-resident fault-log region. This register is treated as read only (0) for implementations not supporting advanced translation fault logging (AFL field reported as 0 in the Capability register). This register is sticky and can be cleared only through powergood reset or via software clearing the RW1C fields by writing a 1.

| Bit | Access | Default Value | RST/PWR | Description |
|-------|--------|---------------|---------|-------------------------------------------------------------------------------------------------------------------------------------------------------------------------------------------------------------------------------------------------------------------------------------------------------------------------------------------------------------------------------------------------------------------------------------------------------------|
| 63:12 | RO | 0s | Core | Fault Log Address (FLA): This field specifies the base of size-aligned fault-log region in system memory. Hardware may ignore bits 63: N, where N is the host address width. Software specifies the base address and size of the fault log region through this register, and programs it in hardware through the SFL field in the Global Command register. When implemented, reads of this field returns value that was last programmed to it. |
| 11:9 | RO | 0s | Core | Fault Log Size (FLS): This field specifies the size of the fault log region pointed by the FLA field. The size of the fault log region is $2X * 4KB$, where X is the value programmed in this register. When implemented, reads of this field returns value that was last programmed to it. |
| 8:0 | RO | 0s | Core | Reserved |

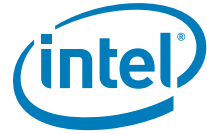

12.3.14 PMEN_REG—Protected Memory Enable Register

B/D/F/Type: 0/2/0/GFXVTBAR
 Address Offset: 64-67h
 Default Value: 00000000h
 Access: R/W, RO
 Size: 32 bits

This register is used to enable the DMA protected memory regions setup through the PLMBASE, PLMLIMIT, PHMBASE, PHMLIMIT registers. When LT.CMD.LOCK.PMRC command is invoked, this register is locked (treated read-only). When the LT.CMD.UNLOCK.PMRC command is invoked, this register is unlocked (treated read/write). This register is always treated as read only (0) for implementations not supporting protected memory regions (PLMR and PHMR fields reported as 0 in the Capability register).

| Bit | Access | Default Value | RST/PWR | Description |
|------|--------|---------------|---------|---------------------------------------------------------------------------------------------------------------------------------------------------------------------------------------------------------------------------------------------------------------------------------------------------------------------------------------------------------------------------------------------------------------------------------------------------------------------------------------------------------------------------------------------------------------------------------------------------------------------------------------------------------------------------------------------------------------------------------------------------------------------------------------------------------------------------------------------------------------------------------------------------------------------------------------------------------------------------------------------------------------------------------------------------------------------------------------------------------------------------------------------------------------------------------------------------------------------------------------------------------------------------------------------------------------------------------------------------------------------------------------------------------------------------------------------------------------------------------------------------------------------------------------------------------------------------------------------------------------------------------|
| 31 | R/W | 0 | Core | <p>Enable Protected Memory Region (EPM): This field controls DMA accesses to the protected low-memory and protected high-memory regions.</p> <p>0 = DMA accesses to protected memory regions are handled as follows:</p> <ul style="list-style-type: none"> — If DMA-remapping hardware is not enabled, DMA requests (including those to protected regions) are not blocked. — If DMA-remapping hardware is enabled, DMA requests are translated per the programming of the DMA-remapping structures. Software may program the DMA-remapping structures to allow or block DMA to the protected memory regions. <p>1 = DMA accesses to protected memory regions are handled as follows:</p> <ul style="list-style-type: none"> — If DMA-remapping hardware is not enabled, DMA to protected memory regions are blocked. These DMA requests are not recorded or reported as DMA-remapping faults. — If DMA-remapping hardware is enabled, hardware may or may not block DMA to the protected memory region(s). Software must not depend on hardware protection of the protected memory regions, and must ensure the DMA-remapping structures are properly programmed to not allow DMA to the protected memory regions. <p>Hardware reports the status of the protected memory enable/disable operation through the PRS field in this register.</p> <p>Hardware implementations supporting DMA draining must drain any in-flight translated DMA requests queued within the root complex before indicating the protected memory region as enabled through the PRS field.</p> |
| 30:1 | RO | 0s | Core | Reserved |
| 0 | RO | 0s | Core | <p>Protected Region Status (PRS): This field indicates the status of protected memory region.</p> <p>0 = Protected memory region(s) not enabled.</p> <p>1 = Protected memory region(s) enabled.</p> |



12.3.15 PLMBASE_REG—Protected Low Memory Base Register

B/D/F/Type: 0/2/0/GFXVTBAR
Address Offset: 68-6Bh
Default Value: 00000000h
Access: RO, R/W
Size: 32 bits

This register is used to setup the base address of DMA protected low-memory region. This register must be setup before enabling protected memory through PMEN_REG, and must not be updated when protected memory regions are enabled.

When LT.CMD.LOCK.PMRC command is invoked, this register is locked (treated RO).

When LT.CMD.UNLOCK.PMRC command is invoked, this register is unlocked (treated as R/W).

This register is always treated as RO for implementations not supporting protected low memory region (PLMR field reported as 0 in the Capability register). The alignment of the protected low memory region base depends on the number of reserved bits (N) of this register. Software may determine the value of N by writing all 1s to this register, and finding most significant zero bit position with 0 in the value read back from the register. Bits N:0 of this register is decoded by hardware as all 0s.

| Bit | Access | Default Value | RST/PWR | Description |
|-------|--------|---------------|---------|----------------------------------------------------------------------------------------------------------------------------|
| 31:21 | R/W | 000h | Core | Protected Low-Memory Base (PLMB): This register specifies the base of protected low-memory region in system memory. |
| 20:0 | RO | 000000h | Core | Reserved |



12.3.16 PLMLIMIT_REG—Protected Low Memory Limit Register

| | |
|-----------------|----------------|
| B/D/F/Type: | 0/2/0/GFXVTBAR |
| Address Offset: | 6C-6Fh |
| Default Value: | 00000000h |
| Access: | R/W, RO |
| Size: | 32 bits |

This register is used to setup the limit address of DMA protected low-memory region. This register must be setup before enabling protected memory through PMEN_REG, and must not be updated when protected memory regions are enabled.

When LT.CMD.LOCK.PMRC command is invoked, this register is locked (treated RO).

When LT.CMD.UNLOCK.PMRC command is invoked, this register is unlocked (treated as R/W).

This register is always treated as RO for implementations not supporting protected low memory region (PLMR field reported as 0 in the Capability register). The alignment of the protected low memory region limit depends on the number of reserved bits (N) of this register. Software may determine the value of N by writing all 1s to this register, and finding most significant zero bit position with 0 in the value read back from the register. Bits N:0 of the limit register is decoded by hardware as all 1s.

The Protected low-memory base & limit registers functions as follows:

- Programming the protected low-memory base and limit registers with the same value in bits 31:(N+1) specifies a protected low-memory region of size 2(N+1) bytes.
- Programming the protected low-memory limit register with a value less than the protected low-memory base register disables the protected low-memory region.

| Bit | Access | Default Value | RST/PWR | Description |
|-------|--------|---------------|---------|--------------------------------------------------------------------------------------------------------------------------------------------------------|
| 31:21 | R/W | 000h | Core | Protected Low-Memory Limit (PLML): This field specifies the last host physical address of the DMA protected low-memory region in system memory. |
| 20:0 | RO | 000000h | Core | Reserved |

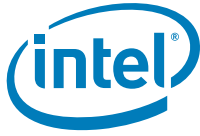

12.3.17 PHMBASE_REG—Protected High Memory Base Register

B/D/F/Type: 0/2/0/GFXVTBAR
Address Offset: 70-77h
Default Value: 0000000000000000h
Access: RO, R/W
Size: 64 bits

This register is used to setup the base address of DMA protected high-memory region. This register must be setup before enabling protected memory through PMEN_REG, and must not be updated when protected memory regions are enabled.

When LT.CMD.LOCK.PMRC command is invoked, this register is locked (treated as RO).

When LT.CMD.UNLOCK.PMRC command is invoked, this register is unlocked (treated as R/W).

This register is always treated as RO for implementations not supporting protected high memory region (PHMR field reported as 0 in the Capability register). The alignment of the protected high memory region base depends on the number of reserved bits (N) of this register. Software may determine the value of N by writing all 1s to this register, and finding most significant zero bit position below host address width (HAW) in the value read back from the register. Bits N:0 of the limit register is decoded by hardware as all 0s.

| Bit | Access | Default Value | RST/PWR | Description |
|-------|--------|---------------|---------|----------------------------------------------------------------------------------------------------------------------------------------------------------------------------------------------------------------------------|
| 63:36 | RO | 0s | Core | Protected High-Memory Base (PHMB_R) |
| 35:21 | R/W | 0s | Core | Protected High-Memory Base (PHMB): This field specifies the base of size aligned, protected memory region in system memory. Hardware may ignore and not implement bits 63:HAW, where HAW is the host address width. |
| 20:0 | RO | 0s | Core | Reserved |



12.3.18 PHMLIMIT_REG—Protected High Memory Limit Register

| | |
|-----------------|-------------------|
| B/D/F/Type: | 0/2/0/GFXVTBAR |
| Address Offset: | 78-7Fh |
| Default Value: | 0000000000000000h |
| Access: | RO, R/W |
| Size: | 64 bits |

This register is used to setup the limit address of DMA protected high-memory region. This register must be setup before enabling protected memory through PMEN_REG, and must not be updated when protected memory regions are enabled.

When LT.CMD.LOCK.PMRC command is invoked, this register is locked (treated as RO).

When LT.CMD.UNLOCK.PMRC command is invoked, this register is unlocked (treated as R/W).

This register is always treated as RO for implementations not supporting protected high memory region (PHMR field reported as 0 in the Capability register). The alignment of the protected high memory region limit depends on the number of reserved bits (N) of this register. Software may determine the value of N by writing all 1s to this register, and finding most significant zero bit position below host address width (HAW) in the value read back from the register. Bits N:0 of the limit register is decoded by hardware as all 1s.

The protected high-memory base & limit registers functions as follows:

- Programming the protected low-memory base and limit registers with the same value in bits HAW: (N+1) specifies a protected low-memory region of size 2(N+1) bytes.
- Programming the protected high-memory limit register with a value less than the protected high-memory base register disables the protected high-memory region.

| Bit | Access | Default Value | RST/PWR | Description |
|-------|--------|---------------|---------|-----------------------------------------------------------------------------------------------------------------------------------------------------------------------------------------------------------------------------------------------------|
| 63:36 | RO | 0s | Core | Protected High-Memory Limit (PHML_R): |
| 35:21 | R/W | 0s | Core | Protected High-Memory Limit (PHML): This register specifies the last host physical address of the DMA protected high-memory region in system memory. Hardware may ignore and not implement bits 63:HAW, where HAW is the host address width. |
| 20:0 | RO | 0s | Core | Reserved |



12.3.19 IVA_REG—Invalidate Address Register

B/D/F/Type: 0/2/0/GFXVTBAR
 Address Offset: 100-107h
 Default Value: 0000000000000000h
 Access: WO, RO
 Size: 64 bits

This register is used to provide the DMA address whose corresponding IOTLB entry needs to be invalidated through the IOTLB Invalidate register. This register is a write only register. The value returned on reads of this register is undefined. There is an IVA_REG for each IOTLB Invalidation unit supported by hardware.

| Bit | Access | Default Value | RST/PWR | Description |
|-------|--------|---------------|---------|------------------------------------------------------------------------------------------------------------------------------------------------------------------------------------------------------------------------------------------------------------------------------------------------------------------------------------------------------------------------------------------------------------------------------------------------------------------------------------------------------------------------------------------------------------------------------------------------------------------------------------------------------------------------------------------------------------------------------------------------------------------------------------------------------------------------------------------------|
| 63:12 | WO | 0s | Core | Address (ADDR): Software provides the DMA address that needs to be page-selectively invalidated. To request a page-selective invalidation request to hardware, software must first write the appropriate fields in this register, and then issue appropriate page-selective invalidate command through the IOTLB_REG. Hardware ignores bits 63:N, where N is the maximum guest address width (MGAW) supported. The value returned on read of this field is undefined. |
| 11:7 | RO | 0s | Core | Reserved |
| 6 | WO | 0 | Core | Invalidation Hint (IH): The field provides hints to hardware to preserve or flush the non-leaf (page-directory) entries that may be cached in hardware. 0 = Software may have modified both leaf and non-leaf page-table entries corresponding to mappings specified in the ADDR and AM fields. On a pageselective invalidation request, hardware must flush both the cached leaf and non-leaf page-table entries corresponding to mappings specified by ADDR and AM fields. 1 = Software has not modified any non-leaf page-table entries corresponding to mappings specified in the ADDR and AM fields. On a page-selective invalidation request, hardware may preserve the cached non-leaf page-table entries corresponding to mappings specified by ADDR and AM fields. Value returned on read of this field is undefined. |



| Bit | Access | Default Value | RST/PWR | Description |
|-----|--------|---------------|---------|---------------------------------------------------------------------------------------------------------------------------------------------------------------------------------------------------------------------------------------------------------------------------------------------------------------------------------------------------------------------------------------------------------------------------------------------------------------------------------------------------------------------------------------------------------------------------------------------------------------------------------------------------------------------------------------------------------------------------------|
| 5:0 | WO | 0s | Core | <p>Address Mask (AM): The value in this field specifies the number of low-order bits of the ADDR field that must be masked for the invalidation operation. Mask field enables software to request invalidation of contiguous mappings for size-aligned regions. For example: Mask Value ADDR bits masked Pages invalidated</p> <p>0 None 1 1 12 2 2 13 : 12 4 3 14 : 12 8 4 15 : 12 16 </p> <p>Hardware implementations report the maximum supported mask value through the Capability register. Value returned on read of this field is undefined.</p> |



12.3.20 IOTLB_REG—IOTLB Invalidate Register

B/D/F/Type: 0/2/0/GFXVTBAR
 Address Offset: 108-10Fh
 Default Value: 0200000000000000h
 Access: R/W, RO
 Size: 64 bits

This register is used to control page-table entry caching. The act of writing the upper byte of the IOTLB_REG with IVT field set causes the hardware to perform the IOTLB invalidation. There is an IOTLB_REG for each IOTLB Invalidation unit supported by hardware.

| Bit | Access | Default Value | RST/PWR | Description |
|-----|--------|---------------|---------|-----------------------------------------------------------------------------------------------------------------------------------------------------------------------------------------------------------------------------------------------------------------------------------------------------------------------------------------------------------------------------------------------------------------------------------------------------------------------------------------------------------------------------------------------------------------------------------------------------------------------------------------------------------------------------------------------------------------------------------------------------------------------------------------------------------------------------------------------------------------------------------------------------------------------------------------------------------------------------------------------------------------------------------------------------------------------------------------------------------------------------------------------------------------------------------------------------------------------------------------------------------------|
| 63 | R/W | 0 | Core | <p>Invalidate IOTLB (IVT): Software requests IOTLB invalidation by setting this field. Software must also set the requested invalidation granularity by programming the IIRG field.</p> <p>Hardware clears the IVT field to indicate the invalidation request is complete. Hardware also indicates the granularity at which the invalidation operation was performed through the IAIG field. Software must not submit another invalidation request through this register while the IVT field is set, nor update the associated Invalidate Address register.</p> <p>Software must not submit IOTLB invalidation requests through any of the IOTLB invalidation units when there is a context-cache invalidation request pending at this DMA-remapping hardware unit.</p> <p>When more than one IOTLB invalidation units are supported by a DMA-remapping hardware unit, software may submit IOTLB invalidation request through any of the currently free units while there are pending requests on other units.</p> <p>Hardware implementations reporting write-buffer flushing requirement (RWBF=1 in Capability register) must implicitly perform a write buffer flushing before reporting invalidation complete to software through the IVT field.</p> |

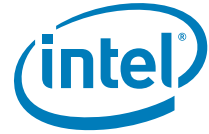

| Bit | Access | Default Value | RST/PWR | Description |
|-------|--------|---------------|---------|---------------------------------------------------------------------------------------------------------------------------------------------------------------------------------------------------------------------------------------------------------------------------------------------------------------------------------------------------------------------------------------------------------------------------------------------------------------------------------------------------------------------------------------------------------------------------------------------------------------------------------------------------------------------------------------------------------------------------------------------------------------------------------------------------------------------------------------------------------------------------------------------------------------------------------------------------------------------------------------------------------------------------------------------------------------------------------------------------------------------------------------------------------------------------------------------------------------------------------------------------------------------------------------------------------------------------------------------------------------------------------------------------------------------------------------------------------------------------------------------------------------------------------------------------------------------------------------------------------------------------------------------|
| 62:60 | R/W | 0s | Core | <p>IOTLB Invalidation Request Granularity (IIRG): When requesting hardware to invalidate the IOTLB (by setting the IVT field), software writes the requested invalidation granularity through this IIRG field.</p> <p>000 = Reserved. Hardware ignores the invalidation request and reports invalidation complete by clearing the IVT field and reporting 000 in the IAIG field.</p> <p>001 = Global invalidation request.</p> <p>010 = Domain-selective invalidation request. The target domain-ID must be specified in the DID field.</p> <p>011 = Domain-page-selective invalidation request. The target address, mask and invalidation hint must be specified in the Invalidate Address register, and the domain-ID must be provided in the DID field.</p> <p>100 = Device-page-selective invalidation request. The target address, mask and invalidation hint must be specified in the Invalidate Address register, the domain-ID must be provided in the DID field, and the device requestor-ID must be provided in SID field.</p> <p>101 - 111 = Reserved. Hardware ignores the invalidation request and reports invalidation complete by clearing the IVT field and reporting 000 in the IAIG field.</p> <p>Depending on the invalidation granularities supported by a hardware implementation, an invalidation request may be processed by performing invalidation at a coarser granularity. Hardware indicates completion of the invalidation request by clearing the IVT field. At this time, the granularity at which actual invalidation was performed is reported through the IAIG field.</p> |



| Bit | Access | Default Value | RST/PWR | Description |
|-------|--------|---------------|---------|---------------------------------------------------------------------------------------------------------------------------------------------------------------------------------------------------------------------------------------------------------------------------------------------------------------------------------------------------------------------------------------------------------------------------------------------------------------------------------------------------------------------------------------------------------------------------------------------------------------------------------------------------------------------------------------------------------------------------------------------------------------------------------------------------------------------------------------------------------------------------------------------------------------------------------------------------------------------------------------------------------------------------------------------------------------------------------------------------------------------------------------------------------------------------------------------------------------------------------------------------------------------------------------------------------------------------------------------------------------------------------------------------------------------------------------------------------------------------------------------------------------------------------------------------------------------------------------------------|
| 59:57 | RO | 1h | Core | <p>IOTLB Actual Invalidation Granularity (IAIG): Hardware reports the granularity at which an invalidation request was proceed through this field at the time of reporting invalidation completion (by clearing the IVT field).</p> <p>000 = Reserved. This indicates hardware detected an incorrect invalidation request and hence ignored the request. Examples of incorrect invalidation requests include specifying a reserved value in the IIRG field or specifying an unsupported address mask value in IVA_REG for page-selective invalidation requests.</p> <p>001 = Global Invalidation performed. This could be in response to a global, domain-selective, domain-page-selective, or device-page-selective invalidation request.</p> <p>010 = Domain-selective invalidation performed using the domain-ID specified by software in the DID field. This could be in response to a domain-selective, domain-page-selective, or device-page-selective invalidation request.</p> <p>011 = Domain-page-selective invalidation performed using the address, mask and hint specified by software in the Invalidate Address register and domain-ID specified in DID field. This can be in response to a domain-page-selective or device-page-selective invalidation request.</p> <p>100 = Device-page-selective invalidation performed using the address, mask and hint specified by software in the Invalidate Address register and device-ID specified in SID field. This can only be in response to a device-page-selective invalidation request.</p> <p>101 - 111 =Reserved.</p> |
| 56:50 | RO | 0 | Core | Reserved |
| 49 | R/W | 0 | Core | <p>Drain Reads (DR): This field is treated as reserved if the DRD field is reported as clear in the Capability register.</p> <p>0 = Hardware may complete the IOTLB invalidation without draining any translated DMA reads that are queued in the root-complex and yet to be processed.</p> <p>1 = Hardware must drain all/relevant translated DMA reads that are queued in the root-complex before indicating IOTLB invalidation completion to software. A DMA read request to system memory is defined as drained when root-complex has finished fetching all of its read response data from memory.</p> |

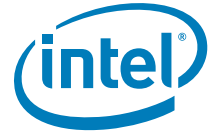

| Bit | Access | Default Value | RST/PWR | Description |
|-------|--------|---------------|---------|---------------------------------------------------------------------------------------------------------------------------------------------------------------------------------------------------------------------------------------------------------------------------------------------------------------------------------------------------------------------------------------------------------------------------------------------------------------------------------------------------------------------------------------------------------------------------------------------------------------------------------------------------|
| 48 | R/W | 0 | Core | <p>Drain Writes (DW): This field is treated as reserved (0) if the DWD field is reported as clear in the Capability register.</p> <p>0 = Hardware may complete the IOTLB invalidation without draining any translated DMA writes that are queued in the root-complex and yet to be processed.</p> <p>1 = Hardware must drain all/relevant translated DMA writes that are queued in the root-complex before indicating IOTLB invalidation completion to software. A DMA write request to system memory is defined as drained when the effects of the write is visible to processor accesses to all addresses targeted by the DMA write.</p> |
| 47:32 | R/W | 0s | Core | <p>Domain-ID (DID): This field indicates the id of the domain whose IOTLB entries needs to be selectively invalidated. This field must be programmed by software for domain-selective, and page-selective invalidation requests. The Capability register reports the domain-ID width supported by hardware. Software must ensure that the value written to this field is within this limit.</p> <p>Hardware may ignore and not implement bits 47: (32+N) where N is the supported domain-ID width reported in the capability register.</p> |
| 31:0 | RO | 0s | Core | Reserved |

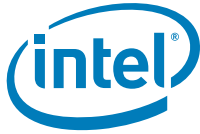

12.3.21 FRCD_REG—Fault Recording Registers

B/D/F/Type: 0/2/0/GFXVTBAR
 Address Offset: 200-20Fh
 Default Value: 00000000000000100000000000000000h
 Access: RO/P, RO, R/WC/P
 Size: 128 bits

This register is used to record DMA-remapping fault information when primary fault logging is active. Hardware reports the number and location of fault recording registers through the Capability register. This register is relevant only for primary fault logging. These registers are sticky and can be cleared only through powergood reset or via software clearing the RW1C fields by writing a 1.

| Bit | Access | Default Value | RST/PWR | Description |
|---------|--------|---------------|---------|--------------------------------------------------------------------------------------------------------------------------------------------------------------------------------------------------------------------------------------------------------------------------------------------------------------------------------------------------------------------------------------------------------------------------------------------------------------------|
| 127 | R/WC/P | 0 | Core | Fault (F): Hardware sets this field to indicate a fault is logged in this Fault Recording register. The F field is Set by hardware after the details of the fault is recorded in other fields. When this field is set, hardware may collapse additional faults from the same source-ID (SID). Software writes the value read from this field to Clear it. |
| 126 | RO/P | 0 | Core | Type (T): Type of the faulted DMA request 0 = DMA write 1 = DMA read request This field is relevant only when the F field is set. |
| 125:124 | RO | 00b | Core | Address Type (AT): This field captures the AT field from the faulted DMA request. Hardware implementations not supporting Device-IOTLBs (DI field Clear in Extended Capability register) treat this field as Reserved. When supported, this field is valid only when the F field is set, and when the fault reason (FR) indicates one of the DMA-remapping fault conditions. NOTE: This field is reserved as this feature is not supported. |
| 123:104 | RO | 0s | Core | Reserved |
| 103:96 | RO/P | 0s | Core | Fault Reason (FR): Reason for the fault. This field is relevant only when the F field is set. |
| 95:80 | RO | 0s | Core | Reserved |
| 79:64 | RO/P | 0010h | Core | Source Identifier (SID): Requester-ID of the faulted DMA request. This field is relevant only when the F field is set. |

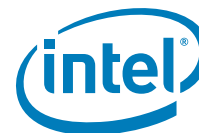

| Bit | Access | Default Value | RST/PWR | Description |
|-------|--------|---------------|---------|---------------------------------------------------------------------------------------------------------------------------------------------------------------------------------------------------------------------------------------------------------------------------------------------------------------------------------------------------------------------------------------------------------------------------------------------------------------------------------------------------------------------------------------------------------------------------------------------------------|
| 63:36 | RO/P | 0s | Core | <p>Fault Info (FI): When the Fault Reason (FR) field indicates one of the DMA-remapping fault conditions, bits 63:12 of this field contains the page address in the faulted DMA request. Hardware treat bits 63:N as reserved (0), where N is the maximum guest address width (MGAW) supported.</p> <p>When the Fault Reason (FR) field indicates one of the interrupt-remapping fault conditions, bits 63:48 of this field indicate the interrupt_index computed for the faulted interrupt request, and bits 47:12 are cleared.</p> <p>This field is relevant only when the F field is Set.</p> |
| 35:32 | RO/P | 0h | Core | <p>Fault Info (FI): When the Fault Reason (FR) field indicates one of the DMA-remapping fault conditions, bits 63:12 of this field contains the page address in the faulted DMA request. Hardware treat bits 63:N as reserved (0), where N is the maximum guest address width (MGAW) supported.</p> <p>When the Fault Reason (FR) field indicates one of the interrupt-remapping fault conditions, bits 63:48 of this field indicate the interrupt_index computed for the faulted interrupt request, and bits 47:12 are cleared.</p> <p>This field is relevant only when the F field is Set.</p> |
| 31:12 | RO/P | 0s | Core | <p>Fault Info (FI): When the Fault Reason (FR) field indicates one of the DMA-remapping fault conditions, bits 63:12 of this field contains the page address in the faulted DMA request. Hardware treat bits 63:N as reserved (0), where N is the maximum guest address width (MGAW) supported.</p> <p>When the Fault Reason (FR) field indicates one of the interrupt-remapping fault conditions, bits 63:48 of this field indicate the interrupt_index computed for the faulted interrupt request, and bits 47:12 are cleared.</p> <p>This field is relevant only when the F field is Set.</p> |
| 11:0 | RO | 0s | Core | Reserved |

§ §

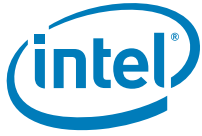

Intel® Virtualization Technology for Directed I/O Registers (D0:F0) (Intel® 82Q45 GMCH Only)



13 Functional Description

13.1 Host Interface

The (G)MCH supports the Intel® Core™2 Extreme processor QX9000 series, Intel® Core™2 Quad processor Q9000 series, and Intel® Core™2 Duo processor E8000 and E7000 series in the LGA775 Land Grid Array Package. The cache line size is 64 bytes. Source synchronous transfer is used for the address and data signals. The address signals are double pumped and a new address can be generated every other bus clock. At 200/267/333MHz bus clock the address signals run at 667MT/s. The data is quad pumped and an entire 64B cache line can be transferred in two bus clocks. At 200/266/333 MHz bus clock, the data signals run at 800/1066/1333 MT/s for a maximum bandwidth of 6.4/8.5/10.6 GB/s.

13.1.1 FSB IOQ Depth

The Scalable Bus supports up to 12 simultaneous outstanding transactions.

13.1.2 FSB OoQ Depth

The (G)MCH supports only one outstanding deferred transaction on the FSB.

13.1.3 FSB GTL+ Termination

The (G)MCH integrates GTL+ termination resistors on die.

13.1.4 FSB Dynamic Bus Inversion

The (G)MCH supports Dynamic Bus Inversion (DBI) when driving and when receiving data from the processor. DBI limits the number of data signals that are driven to a low voltage on each quad pumped data phase. This decreases the worst-case power consumption of the (G)MCH. FSB_DINVB_[3:0] indicate if the corresponding 16 bits of data are inverted on the bus for each quad pumped data phase:

| FSB_DINVB_[3:0] | Data Bits |
|-----------------|-----------------|
| FSB_DINVB_0 | FSB_DB_[15:0]# |
| FSB_DINVB_1 | FSB_DB_[31:16]# |
| FSB_DINVB_2 | FSB_DB_[47:32]# |
| FSB_DINVB_3 | FSB_DB_[63:48]# |

Whenever the processor or the (G)MCH drives data, each 16-bit segment is analyzed. If more than 8 of the 16 signals would normally be driven low on the bus, the corresponding FSB_DINVB signal will be asserted, and the data will be inverted prior to being driven on the bus. Whenever the processor or the (G)MCH receives data, it monitors FSB_DINVB_[3:0] to determine if the corresponding data segment should be inverted.

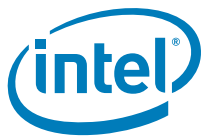

Table 29. Host Interface 4X, 2X, and 1X Signal Groups

| Signals | Associated Clock or Strobe | Signal Group |
|-----------------------------------------------------------------------------------------------------------------------------------|----------------------------|--------------|
| FSB_ADSB, FSB_BNRB, FSB_BPRIB, FSB_DEFERB, FSB_DBSYB, FSB_DRDYB, FSB_HITB, FSB_HITMB, FSB_LOCKB, FSB_RSB_[2:0], FSB_TRDYB, RSTINB | HPL_CLKINP HPL_CLKINN | 1X |
| FSB_AB_[16:3], FSB_REQB_[4:0] | FSB_ADSTBB_0 | 2X |
| FSB_AB_[35:17] | FSB_ADSTBB_1 | |
| FSB_DB_[15:0], FSB_DINVB_0 | FSB_DSTBPB_0, FSB_DSTBNB_0 | 4X |
| FSB_DB_[31:16], FSB_DINVB_1 | FSB_DSTBPB_1, FSB_DSTBNB_1 | |
| FSB_DB_[47:32], FSB_DINVB_2 | FSB_DSTBPB_2, FSB_DSTBNB_2 | |
| FSB_DB_[63:48], FSB_DINVB_3 | FSB_DSTBPB_3, FSB_DSTBNB_3 | |

13.1.5 APIC Cluster Mode Support

APIC Cluster mode support is required for backwards compatibility with existing software, including various operating systems.

The (G)MCH supports three types of interrupt re-direction:

- Physical
- Flat-Logical
- Clustered-Logical

If more than one xTPR register set in the arbitration pool has the same lowest value, or if all enabled xTPR Task Priority fields are 1111b, the xTPR register set referenced by the lowest value **TPR_SEL[3:0]** is the “winner”.

The “winning” xTPR register set provides the values to be substituted in the Aa[19:12]# and Aa[7:4]# fields of the FSB Interrupt Message Transaction driven by the (G)MCH.



13.2 System Memory Controller

The (G)MCH system memory controller supports both DDR2 and DDR3 protocols with two independent 64 bit wide channels each accessing one or two DIMMs. The controller supports a maximum of two non-ECC DDR2 DIMMs or two un-buffered non-ECC DDR3 DIMMs per channel; thus, allowing up to four device ranks per channel. Intel® Fast Memory Access (FMA) supported.

Note: The 82G41 GMCH only supports 1 DIMM per channel. References to 2 DIMMs per channel only apply to the 82Q45, 82Q43, 82B43, 82G45, 82G43 GMCH and 82P45, 82P43 MCH. The 82G43 supports 1 or 2 DIMMs per channel depending upon part.

13.2.1 System Memory Organization Modes

The system memory controller supports two memory organization modes: Single Channel and Dual Channel.

13.2.1.1 Single Channel Mode

In this mode, all memory cycles are directed to a single channel.

Single channel mode is used when either Channel A or Channel B DIMMs are populated in any order, but not both.

13.2.1.2 Dual Channel Modes

13.2.1.2.1 Dual Channel Symmetric Mode

This mode provides maximum performance on real applications. Addresses are ping-ponged between the channels after each cache line (64 byte boundary). If there are two requests, and the second request is to an address on the opposite channel from the first, that request can be sent before data from the first request has returned. If two consecutive cache lines are requested, both may be retrieved simultaneously, since they are assured to be on opposite channels.

Dual channel symmetric mode is used when both Channel A and Channel B DIMMs are populated in any order with the total amount of memory in each channel being the same, but the DRAM device technology and width may vary from one channel to the other.

Table 30 is a sample dual channel symmetric memory configuration showing the rank organization.

Table 30. Sample System Memory Dual Channel Symmetric Organization Mode

| Rank | Channel 0 Population | Cumulative Top Address in Channel 0 | Channel 1 Population | Cumulative Top Address in Channel 1 |
|--------|----------------------|-------------------------------------|----------------------|-------------------------------------|
| Rank 3 | 0 MB | 2560 MB | 0 MB | 2560 MB |
| Rank 2 | 256 MB | 2560 MB | 256 MB | 2560 MB |
| Rank 1 | 512 MB | 2048 MB | 512 MB | 2048 MB |
| Rank 0 | 512 MB | 1024 MB | 512 MB | 1024 MB |



13.2.1.2.2 Dual Channel Asymmetric Mode with Intel® Flex Memory Mode Enabled

In this addressing mode the lowest DRAM memory is mapped to dual channel operation and the top most DRAM memory is mapped to single channel operation. In this mode the system can run at one zone of dual channel mode and one zone of single channel mode simultaneously across the whole memory array.

This mode is used when Intel® Flex Memory Mode is enabled and both Channel A and Channel B DIMMs are populated in any order with the total amount of memory in each channel being different.

Table 31 is a sample dual channel asymmetric memory configuration showing the rank organization with Intel® Flex Memory Mode Enabled.

Table 31. Sample System Memory Dual Channel Asymmetric Organization Mode with Intel® Flex Memory Mode Enabled

| Rank | Channel 0 population | Cumulative top address in Channel 0 | Channel 1 population | Cumulative top address in Channel 1 |
|--------|----------------------|-------------------------------------|----------------------|-------------------------------------|
| Rank 3 | 0 MB | 2048 MB | 0 MB | 2304 MB |
| Rank 2 | 0 MB | 2048 MB | 256 MB | 2304 MB |
| Rank 1 | 512 MB | 2048 MB | 512 MB | 2048 MB |
| Rank 0 | 512 MB | 1024 MB | 512 MB | 1024 MB |

13.2.1.2.3 Dual Channel Asymmetric Mode with Intel® Flex Memory Mode Disabled (Stacked Mode)

In this addressing mode addresses start in channel 0 and stay there until the end of the highest rank in channel 0, and then addresses continue from the bottom of channel 1 to the top.

This mode is used when Intel® Flex Memory Mode is disabled and both Channel A and Channel B DIMMs are populated in any order with the total amount of memory in each channel being different.

Table 32 is a sample dual channel asymmetric memory configuration showing the rank organization with Intel® Flex Memory Mode Disabled.

Table 32. Sample System Memory Dual Channel Asymmetric Organization Mode with Intel® Flex Memory Mode Disabled

| Rank | Channel 0 population | Cumulative top address in Channel 0 | Channel 1 population | Cumulative top address in Channel 1 |
|--------|----------------------|-------------------------------------|----------------------|-------------------------------------|
| Rank 3 | 0 MB | 1280 MB | 0 MB | 2304 MB |
| Rank 2 | 256 MB | 1280 MB | 0 MB | 2304 MB |
| Rank 1 | 512 MB | 1024 MB | 512 MB | 2304 MB |
| Rank 0 | 512 MB | 512 MB | 512 MB | 1792 MB |



13.2.2 System Memory Technology Supported

The (G)MCH supports the following DDR2 and DDR3 Data Transfer Rates, DIMM Modules, and DRAM Device Technologies:

- DDR2 Data Transfer Rates: 667 (PC2-5300) and 800 (PC2-6400)
- DDR3 Data Transfer Rates: 800 (PC3-6400) and 1066 (PC3-8500)
- DDR2 DIMM Modules:
 - Raw Card C - Single Sided x16 un-buffered non-ECC
 - Raw Card D - Single Sided x8 un-buffered non-ECC
 - Raw Card E - Double Sided x8 un-buffered non-ECC
- DDR3 DIMM Modules:
 - Raw Card A - Single Sided x8 un-buffered non-ECC
 - Raw Card B - Double Sided x8 un-buffered non-ECC
 - Raw Card C - Single Sided x16 un-buffered non-ECC
 - Raw Card F - Double Sided x16 un-buffered non-ECC
- DDR2 DRAM Device Technology: 512-Mb, 1-Gb, and 2-Gb
- DDR3 DRAM Device Technology: 512-Mb and 1-Gb

Table 33. Supported DIMM Module Configurations

| Memory Type | Raw Card Version | DIMM Capacity | DRAM Device Technology | DRAM Organization | # of DRAM Devices | # of Physical Device Ranks | # of Row/ Col Address Bits | # of Banks Inside DRAM | Page Size |
|-----------------------------------------|------------------|---------------|------------------------|-------------------|-------------------|----------------------------|----------------------------|------------------------|-----------|
| DDR2 667 and 800 (see note) | C | 256MB | 512Mb | 32M X 16 | 4 | 1 | 13/10 | 4 | 8K |
| | | 512MB | 1Gb | 64M X 16 | 4 | 1 | 13/10 | 8 | 8K |
| | D | 512MB | 512Mb | 64M X 8 | 8 | 1 | 14/10 | 4 | 8K |
| | | 1GB | 1Gb | 128M X 8 | 8 | 1 | 14/10 | 8 | 8K |
| | E | 1GB | 512Mb | 64M X 8 | 16 | 2 | 14/10 | 4 | 8K |
| | | 2GB | 1Gb | 128M X 8 | 16 | 2 | 14/10 | 8 | 8K |
| | F | 512MB | 512Mb | 64M X 8 | 9 | 1 | 14/10 | 4 | 8K |
| | | 1GB | 1Gb | 128M X 8 | 9 | 1 | 14/10 | 8 | 8K |
| | G | 1GB | 512Mb | 64M X 8 | 18 | 2 | 14/10 | 4 | 8K |
| | | 2GB | 1Gb | 128M X 8 | 18 | 2 | 14/10 | 8 | 8K |
| DDR3 800 and 1066 | A | 512 MB | 512Mb | 64M X 8 | 8 | 1 | 13/10 | 8 | 8K |
| | | 1 GB | 1Gb | 128M X 8 | 8 | 1 | 14/10 | 8 | 8K |
| | B | 1 GB | 512Mb | 64M X 8 | 16 | 2 | 13/10 | 8 | 8K |
| | | 2 GB | 1Gb | 128M X 8 | 16 | 2 | 14/10 | 8 | 8K |
| | C | 256 MB | 512Mb | 32M X 16 | 4 | 1 | 12/10 | 8 | 8K |
| | | 512 MB | 1Gb | 64M X 16 | 4 | 1 | 13/10 | 8 | 8K |
| | F | 512 MB | 512Mb | 32M X 16 | 8 | 2 | 12/10 | 8 | 8K |
| | | 1 GB | 1Gb | 64M X 16 | 8 | 2 | 13/10 | 8 | 8K |



13.3 PCI Express*

See [Section 1.2](#) for a list of PCI Express features, and the *PCI Express Specification* for further details.

This (G)MCH is part of a PCI Express root complex. This means it connects a host processor/memory subsystem to a PCI Express hierarchy. The control registers for this functionality are located in Device 1 and Device 6 configuration space and two Root Complex Register Blocks (RCRBs). The DMI RCRB contains registers for control of the ICH10/ICH7 attach ports.

13.3.1 PCI Express* Architecture

The PCI Express architecture is specified in layers. Compatibility with the PCI addressing model (a load-store architecture with a flat address space) is maintained to ensure that all existing applications and drivers operate unchanged. The PCI Express configuration uses standard mechanisms as defined in the PCI Plug-and-Play specification. The initial speed of 1.25 GHz (250 MHz internally) results in 2.5 Gb/s each direction which provides a 250 MB/s communications channel in each direction (500 MB/s total) that is close to twice the data rate of classic PCI per lane.

13.3.1.1 Transaction Layer

The upper layer of the PCI Express architecture is the Transaction Layer. The Transaction Layer's primary responsibility is the assembly and disassembly of Transaction Layer Packets (TLPs). TLPs are used to communicate transactions, such as read and write, as well as certain types of events. The Transaction Layer also manages flow control of TLPs.

13.3.1.2 Data Link Layer

The middle layer in the PCI Express stack, the Data Link Layer, serves as an intermediate stage between the Transaction Layer and the Physical Layer. Responsibilities of Data Link Layer include link management, error detection, and error correction.

13.3.1.3 Physical Layer

The Physical Layer includes all circuitry for interface operation, including driver and input buffers, parallel-to-serial and serial-to-parallel conversion, PLL(s), and impedance matching circuitry.

13.3.2 PCI Express* on (G)MCH

The (G)MCH has two PCIe Gen 2.0 controllers to support 1x16 graphics or 2x8 graphics modes. To support 1x16 and 2x8 graphics the system should incorporate two graphics ports- Primary port and Secondary port. Each port is a 1x16 physical connector but 1x8 electrically.

Note: Not all of the above configurations are supported on all Intel 4 Series Chipset (G)MCH components. Refer to [Table 1](#) in [Chapter 1](#) for (G)MCH components supporting specific features.

On plugging a PCI Express Gen 2.0 1x16 PCIe graphics card into the primary port the transaction between the (G)MCH and the PCI Express graphics card will take place along all the 16 PCI Express lanes. When graphic cards are plugged into both the primary and secondary ports transaction between the (G)MCH and the graphics card

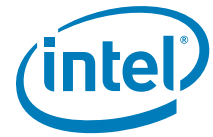

will take place along 8 of the PCI express lanes through each ports. This means that when two x16 graphics cards are plugged into both the slots, the (G)MCH will dynamically down sample and transaction takes place only through 8 lanes.

The PCI Express controllers on the (G)MCH has been designed to support ADD2 and MEC only the primary slot. When a ADD2 or MEC card is plugged into the secondary slot, the card will not function.

Table 34 shows the usage models supported on the (G)MCH for PCI Express graphics cards, ADD2 and ADD2+ cards.

Table 34. Supported Usage Models

| Ports | PCIe Graphics Card | MEC | ADD2 |
|----------------|---------------------------------------------------------------------------------------------|-----|------|
| Primary Slot | PCIex16 card in stand alone PCIe x8 card in dual graphics mode | X | X |
| Secondary Slot | PCIe x8 card in dual graphics mode No support available with card only in secondary slot | N/A | N/A |

NOTE: X indicates support available is N/A - Support not available.

13.4 Integrated Graphics Device (Intel® 82Q45, 82Q43, 82B43, 82G45, 82G43 GMCH Only)

This section details the chipset integrated graphics engines (3D, 2D, and Video), 3D pipeline, and the respective capabilities.

The GMCH graphics device supports ten fully programmable execution cores, enabling greater performance than previous generation chipsets.

The GMCH internal graphics devices (IGD) contain several types of components. The major components in the IGD are the engines, planes, pipes, and ports. The GMCH has a 3D/2D Instruction Processing unit to control the 3D and 2D engines, respectively. The IGD's 3D and 2D engines are fed with data through the memory controller. The outputs of the engines are surfaces sent to memory, which are then retrieved and processed by GMCH planes.

Figure 10. GMCH Graphics Controller Block Diagram

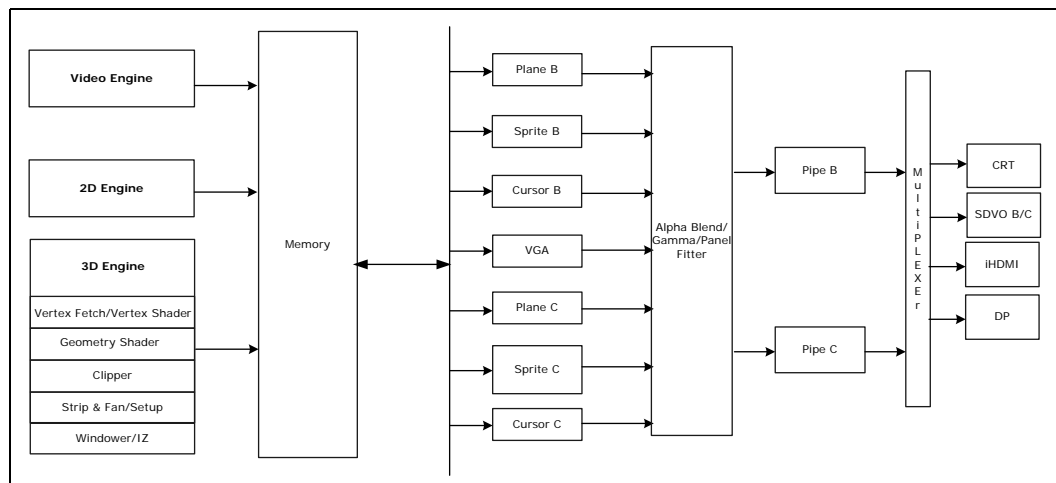

13.4.1 3D and Video Engines for Graphics Processing

The 3D graphics pipeline for the chipset has a deep pipelined architecture in which each stage can simultaneously operate on different primitives or on different portions of the same primitive. All the cores are fully programmable, increasing the versatility of the 3D Engine.

The 3D engine also has a number of performance and power-management enhancements, providing improved power/performance ratios over the IGD. These include:

- Execution Units increased to 10 from the previous 8 EUs
- Improved HDDVD hardware acceleration
- Graphics support for Intel Virtualization Technology DMA
- Graphics support for Intel TXT (82Q45/82Q43 GMCH Only)
- Intel HD Audio Playback AVC/VC1 decoding in hardware



13.4.1.1 3D Engine Execution Units (EUs)

The 3D processing hardware includes support for 2 more EUs over the previous generation. The EUs perform 128-bit wide execution per clock and are support SIMD8 instructions for vertex processing and SIMD16 instructions for pixel processing.

13.4.1.2 3D Pipeline

13.4.1.2.1 Vertex Fetch (VF) Stage

The VF stage performs one major function: executing 3DPRIMITIVE commands. Some enhancements have been included to better support legacy DirectX 3D APIs as well as OpenGL.

13.4.1.2.2 Vertex Shader (VS) Stage

The VS stage of the 3D pipeline is used to perform shading of vertices output by the VF function. The VS unit will, thus, produce an output vertex reference for every input vertex reference received from the VF unit, in the order received.

13.4.1.2.3 Geometry Shader (GS) Stage

The GS stage receives inputs from the previous VS stage. Compiled application-provided GS shader programs specify an algorithm to convert the vertices of an input object into some output primitives. For example, a GS shader may convert lines of a line strip into polygons representing a corresponding segment of a blade of grass centered on the line. Or it could use adjacency information to detect silhouette edges of triangles and output polygons extruding out from the those edges.

13.4.1.2.4 Clip Stage

The CLIP stage can be used to perform general processing on incoming 3D objects. However, it also includes specialized logic to perform a ClipTest function on incoming object. The Clip Test optimizes generalized 3D Clipping. The Clip unit examines the position of incoming vertices, and accepts/rejects 3D objects based on its Clip algorithm.

13.4.1.2.5 Strips and Fans Stage

The Strips and Fans (SF) stage of the 3D pipeline is responsible for performing setup operations required to rasterize 3D objects. The outputs from the SF stage to the Windower stage comprise of implementation-specific information required for the rasterization of objects and also supports clipping of primitives to some extent.

13.4.1.2.6 Windower/IZ (WIZ) Stage

The WIZ unit performs an early depth test, a major performance-optimization feature where failing pixels are removed; thus, eliminating unnecessary processing overhead.

The Windower uses the parameters provided by the SF unit in the object-specific rasterization algorithms. The WIZ unit rasterizes objects into the corresponding set of pixels.

The Windower is also capable of performing dithering, whereby the illusion of a higher resolution when using low-bpp channels in color buffers is possible. Color dithering tends to diffuse the sharp color bands seen on smooth-shaded objects.



13.4.2 Video Engine

The Video Engine handles the non-3D (media/video) applications. It includes support for VLD and MPEG2 decode in Hardware. The GMCH engine includes a number of encompassments over the previous generation capabilities, which have been listed above.

13.4.3 2D Engine

The GMCH contains BLT (Block Level Transfer) functionality and an extensive set of 2D instructions. To take advantage of the 3D drawing engine's functionality, some BLT functions make use of the 3D renderer.

13.4.3.1 Chipset VGA Registers

The 2D registers are a combination of registers for the original Video Graphics Array (VGA) and others to support graphics modes that have color depths, resolutions, and hardware acceleration features that go beyond the original VGA standard.

13.4.3.2 Logical 128-Bit Fixed BLT and 256 Fill Engine

Use of this BLT engine accelerates the Graphical User Interface (GUI) of Microsoft Windows* operating systems. The 128-bit GMCH BLT Engine provides hardware acceleration of block transfers of pixel data for many common Windows operations. The term BLT refers to a block transfer of pixel data between memory locations. The BLT engine can be used for the following:

- Move rectangular blocks of data between memory locations
- Data Alignment
- Perform logical operations (raster ops)

The rectangular block of data does not change as it is transferred between memory locations. The allowable memory transfers are between: cacheable system memory and frame buffer memory, frame buffer memory and frame buffer memory, and within system memory. Data to be transferred can consist of regions of memory, patterns, or solid color fills. A pattern will always be 8x8 pixels wide and may be 8, 16, or 32 bits per pixel.

The BLT engine has the ability to expand monochrome data into a color depth of 8, 16, or 32 bits. BLTs can be either opaque or transparent. Opaque transfers move the data specified to the destination. Transparent transfers compare destination color to source color and write according to the mode of transparency selected.

Data is horizontally and vertically aligned at the destination. If the destination for the BLT overlaps with the source memory location, the GMCH can specify which area in memory to begin the BLT transfer. Hardware is included for all 256 raster operations (Source, Pattern, and Destination) defined by Microsoft, including transparent BLT.

The GMCH has instructions to invoke BLT and stretch BLT operations, permitting software to set up instruction buffers and use batch processing. The GMCH can perform hardware clipping during BLTs.



13.5 Display Interfaces (Intel® 82Q45, 82Q43, 82B43, 82G45, 82G43, 82G41 GMCH Only)

The GMCH has three display ports, one analog and two digital ports B and C. Each port can transmit data according to one or more protocols. The digital ports B and C can be configured to drive natively HDMI, DVI and Display Port or can be connected to an external device (SDVO) that converts one protocol to another. Examples of SDVO devices are TV encoders, external DACs, LVDS transmitters, HDMI transmitters, and TMDs transmitters. Each display port has control signals that may be used to control, configure and/or determine the capabilities of an external device.

The GMCH has one dedicated display port, the analog port. Digital ports B and C are multiplexed with the PCI Express Graphics (PEG) interface and are not available if an external PEG device is in use. The digital ports can also be configured to drive SDVO data. When a system uses a PEG connector, SDVO ports B and C can be used via an ADD2 (Advanced Digital Display 2) or MEC (Media Expansion Card).

- The GMCH's analog port uses an integrated 350 MHz RAMDAC that can directly drive a standard progressive scan analog monitor up to a resolution of 2048x1536 pixels with 32-bit color at 75 Hz.
- The GMCH's SDVO ports are each capable of driving a 400 MP pixel rate. Each port is capable of driving a digital display up to 2560x1600 @ 60Hz.

Integrated HDMI, DVI, and Display Port support multiplexed over PCI Express Graphics port for native connection to a compatible display.

13.5.1 Analog Display Port Characteristics

The analog display port provides a RGB signal output along with a HSYNC and VSYNC signal. There is an associated DDC signal pair that is implemented using GPIO pins dedicated to the analog port. The intended target device is for a CRT based monitor with a VGA connector. Display devices such as LCD panels with analog inputs may work satisfactory but no functionality added to the signals to enhance that capability.

Table 35. Analog Port Characteristics

| Signal | Port Characteristic | Support |
|----------------|-------------------------|---------------------------|
| RGB | Voltage Range | 0.7 V p-p only |
| | Monitor Sense | Analog Compare |
| | Analog Copy Protection | No |
| | Sync on Green | No |
| HSYNC VSYNC | Voltage | 2.5 V |
| | Enable/Disable | Port control |
| | Polarity adjust | VGA or port control |
| | Composite Sync Support | No |
| | Special Flat Panel Sync | No |
| | Stereo Sync | No |
| DDC | Voltage | Externally buffered to 5V |
| | Control | Through GPIO interface |



13.5.1.1 Integrated RAMDAC

The display function contains a RAM-based Digital-to-Analog Converter (RAMDAC) that transforms the digital data from the graphics and video subsystems to analog data for the CRT monitor. GMCH's integrated 350 MHz RAMDAC supports resolutions up to 2048 x 1536 @ 75 Hz. Three 8-bit DACs provide the R, G, and B signals to the monitor.

13.5.1.2 Sync Signals

HSYNC and VSYNC signals are digital and conform to TTL signal levels at the connector. Since these levels cannot be generated internal to the device, external level shifting buffers are required. These signals can be polarity adjusted and individually disabled in one of the two possible states. The sync signals should power up disabled in the high state. No composite sync or special flat panel sync support will be included.

13.5.1.3 VESA/VGA Mode

VESA/VGA mode provides compatibility for pre-existing software that set the display mode using the VGA CRTC registers. Timings are generated based on the VGA register values and the timing generator registers are not used.

13.5.1.4 DDC (Display Data Channel)

DDC is a standard defined by VESA. Its purpose is to allow communication between the host system and display. Both configuration and control information can be exchanged allowing plug- and-play systems to be realized. Support for DDC 1 and DDC 2 is implemented. The GMCH uses the CRT_DDC_CLK and CRT_DDC_DATA signals to communicate with the analog monitor. The GMCH will generate these signals at 2.5 V. External pull-up resistors and level shifting circuitry should be implemented on the board.

The GMCH implements a hardware GMBus controller that can be used to control these signals allowing for transactions speeds up to 400 kHz.

13.5.2 Digital Display Interface

The GMCH can drive HDMI, DVI, and Display Port natively. The digital ports B and/or C can be configured to drive HDMI, DVI, and Display Port. The digital ports are multiplexed on to the PEG interface.

13.5.2.1 High Definition Multimedia Interface (Intel® 82G45, 82G43, 82G41, 82B43 GMCH Only)

The High-Definition Multimedia Interface (HDMI) is provided for transmitting uncompressed digital audio and video signals from DVD players, set-top boxes, and other audiovisual sources to television sets, projectors, and other video displays. It can carry high-quality multi-channel audio data and all standard and high-definition consumer electronics video formats.

HDMI display interface connecting the GMCH and display devices uses transition minimized differential signaling (TMDS) to carry audiovisual information through the same HDMI cable.

HDMI includes three separate communications channels: TMDS, DDC, and the optional CEC (consumer electronics control). As shown in [Figure 11](#), the HDMI cable carries four differential pairs that make up the TMDS data and clock channels. These channels are used to carry video, audio and auxiliary data. In addition, HDMI carries a VESA Display data channel (DDC). The DDC channel is used by an HDMI Source to determine the capabilities and characteristics of the Sink.



Audio, video and auxiliary (control/status) data is transmitted across the three TMDS data channels. The video pixel clock is transmitted on the TMDS clock channel and is used by the receiver for data recovery on the three data channels.

The digital display data signals driven natively through the GMCH are AC coupled and needs level shifter to convert the AC coupled signals to the HDMI compliant digital signals.

Note: HDMI support on 82B43 is enabled via Intel® Upgrade Service

Figure 11. HDMI Overview

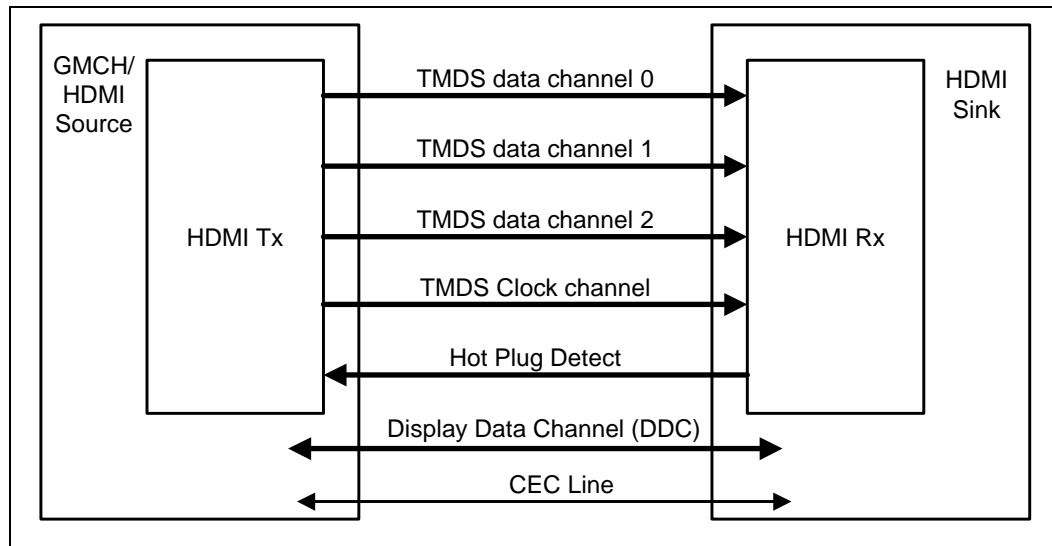

13.5.2.2 Digital Video Interface (DVI)

GMCH digital ports can be configured to drive DVI-D. DVI uses TMDS for transmitting data from the transmitter to the receiver which is similar to the HDMI protocol but the audio and CEC. Refer to the HDMI section for more information on the signals and data transmission.

To drive DVI-I through the back panel the VGA DDC signals are connected along with the digital data and clock signals from one of the digital ports. When a system has support for DVI-I port, then either VGA or the DVI-D through a single DVI-I connector can be driven but not both simultaneously.

The digital display data signals driven natively through the GMCH are AC coupled and needs level shifter to convert the AC coupled signals to the HDMI compliant digital signals.

13.5.2.3 DDPC_CTRLDATA and DDPC_CTRLCLK

The GMCH incorporates an I²C bus for digital Port C to allow communication between the host system and display. Both configuration and control information can be exchanged between the system and the digital monitor allowing plug- and-play systems to be realized.

The GMCH generates these signals at 3.3 V. External pull-up resistors and level shifting circuitry should be implemented on the board. This signal shall be used to configure digital port C as either HDMI or DVI.

13.5.2.4 Display Port

Display Port is a digital communication interface that utilizes differential signalling to achieve a high bandwidth bus interface designed to support connections between PCs and monitors, projectors, and TV displays. Display port is also suitable for display connections between consumer electronics devices such as high definition optical disc players, set top boxes, and TV displays.

A Display Port consists of a Main Link, Auxiliary channel, and a Hot Plug Detect signal. The Main Link is a uni-directional, high-bandwidth, and low latency channel used for transport of isochronous data streams such as uncompressed video and audio. The Auxiliary Channel (AUX CH) is a half-duplex bi-directional channel used for link management and device control. The Hot Plug Detect (HPD) signal serves as an interrupt request for the sink device.

Figure 12. Display Port Overview

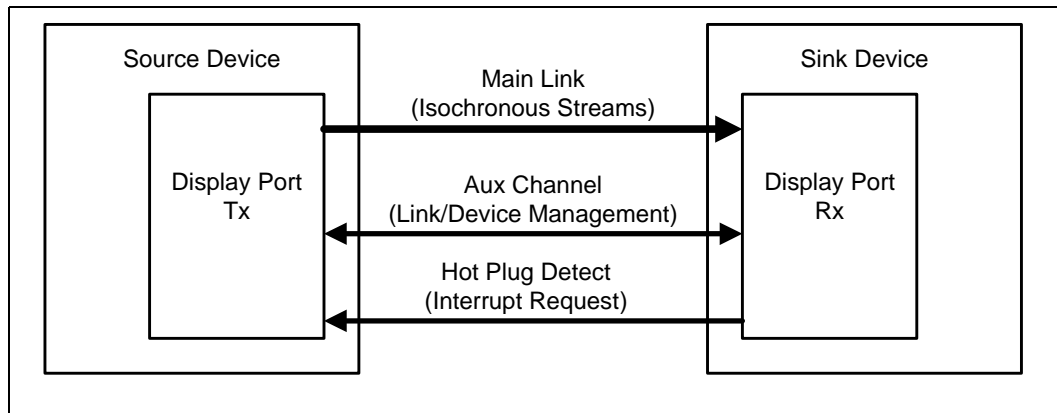

13.5.2.5 Auxiliary Channel (AUX CH)

The Auxiliary channel consists of an AC-coupled, bi-directional differential pair, providing a data rate of 1 Mbps. It is used for link management and device control (that is, for transmitting control and status information).

AUX CH is multiplexed to the PCI Express Rx lanes.

13.5.2.6 PEG Mapping of digital display signals

Table 36 shows the PEG mapping of HDMI(DVI), Display Port, and SDVO signals.



Table 36. (G)MCH PCI Express TX/RX Mapping of Supported Display Technologies

| PCI Express Differential pair lanes | PCI Express Differential pair lanes with lane reversal | DisplayPort Signals | HDMI /DVI Signals | SDVO signals | Description |
|-------------------------------------|--------------------------------------------------------|---------------------|-------------------|----------------|-----------------------------------------------|
| PEG_TXP_7 | PEG_TXP_8 | DPC_LANE3 | TMDSCLK1 | SDVOC_CLK | DisplayPort C or HDMI C or SDVO C |
| PEG_TXN_7 | PEG_TXN_8 | DPC_LANE3# | TMDSCLK1# | SDVOC_CLK# | |
| PEG_TXP_6 | PEG_TXP_9 | DPC_LANE2 | TMDSDATA0 | SDVOC_BLUE | |
| PEG_TXN_6 | PEG_TXN_9 | DPC_LANE2# | TMDSDATA0# | SDVOC_BLUE# | |
| PEG_TXP_5 | PEG_TXP_10 | DPC_LANE1 | TMDSDATA1 | SDVOC_GREEN | |
| PEG_TXN_5 | PEG_TXN_10 | DPC_LANE1# | TMDSDATA1# | SDVOC_GREEN# | |
| PEG_TXP_4 | PEG_TXP_11 | DPC_LANE0 | TMDSDATA2 | SDVOC_RED | |
| PEG_TXN_4 | PEG_TXN_11 | DPC_LANE0# | TMDSDATA2# | SDVOC_RED# | |
| PEG_TXP_3 | PEG_TXP_12 | DPB_LANE3 | TMDSB_CLK2 | SDVOB_CLK | DisplayPort B or HDMI B or SDVO B |
| PEG_TXN_3 | PEG_TXN_12 | DPB_LANE3# | TMDSB_CLK2# | SDVOB_CLK# | |
| PEG_TXP_2 | PEG_TXP_13 | DPB_LANE2 | TMDSB_DATA0 | SDVO_BLUE | |
| PEG_TXN_2 | PEG_TXN_13 | DPB_LANE2# | TMDSB_DATA0# | SDVO_BLUE# | |
| PEG_TXP_1 | PEG_TXP_14 | DPB_LANE1 | TMDSB_DATA1 | SDVOB_GREEN | |
| PEG_TXN_1 | PEG_TXN_14 | DPB_LANE1# | TMDSB_DATA1# | SDVOB_GREEN# | |
| PEG_TXP_0 | PEG_TXP_15 | DPB_LANE0 | TMDSB_DATA2 | SDVOB_RED | |
| PEG_TXN_0 | PEG_TXN_15 | DPB_LANE0# | TMDSB_DATA2# | SDVOB_RED# | |
| PEG_RXP_7 | PEG_RXP_8 | DPC_HPD | TMDS_HPD | | HPD for DP C and HDMI C |
| PEG_RXN_7 | PEG_RXN_8 | | | | |
| PEG_RXP_6 | PEG_RXP_9 | DPC_AUX | | | AUX CH for Display port C |
| PEG_RXN_6 | PEG_RXN_9 | DPC_AUX# | | | |
| PEG_RXP_5 | PEG_RXP_10 | | | SDVOC_INT | |
| PEG_RXN_5 | PEG_RXN_10 | | | SDVOC_INTB | |
| PEG_RXP_4 | PEG_RXP_11 | | | | |
| PEG_RXN_4 | PEG_RXN_11 | | | | |
| PEG_RXP_3 | PEG_RXP_12 | DPC_HPD | HDMIB_HPD | | HPD for DP B and HDMI B |
| PEG_RXN_3 | PEG_RXN_12 | | | | |
| PEG_RXP_2 | PEG_RXP_13 | DPB_AUX | | SDVO_FLDSTALL | SDVO |
| PEG_RXN_2 | PEG_RXN_13 | DPB_AUX# | | SDVO_FLDSTALL# | |
| PEG_RXP_1 | PEG_RXP_14 | | | SDVO_INT | |
| PEG_RXN_1 | PEG_RXN_14 | | | SDVO_INT# | |
| PEG_RXP_0 | PEG_RXP_15 | | | SDVO_TVCLKIN | |
| PEG_RXN_0 | PEG_RXN_15 | | | SDVO_TVCLKIN# | |

13.5.2.7 Multiplexed Digital Display Channels – Intel® SDVOB and Intel® SDVOC

The GMCH supports digital display devices through two SDVO ports multiplexed with the PEG signals. When an external graphics accelerator is used via the PEG port, these SDVO ports are not available.

The shared SDVO ports each support a pixel clock up to 200 MHz and can support a variety of transmission devices.

SDVO_CTRLDATA is an open-drain signal that acts as a strap during reset to tell the GMCH whether the interface is a PCI Express interface or an SDVO interface. When implementing SDVO, either using ADD2 cards or with a down device, a pull-up resistor is placed on this line to signal to the GMCH to run in SDVO mode and for proper GMBus operation.

13.5.2.7.1 ADD2/MEDIA EXPANSION CARD(MEC)

When a PEG connector is used in the platform, the multiplexed SDVO ports may be used via an ADD2 or MEC card. The ADD2 card will be designed to fit a standard PCI Express (x16) connector.

Figure 13. Display configurations on ATX Platforms

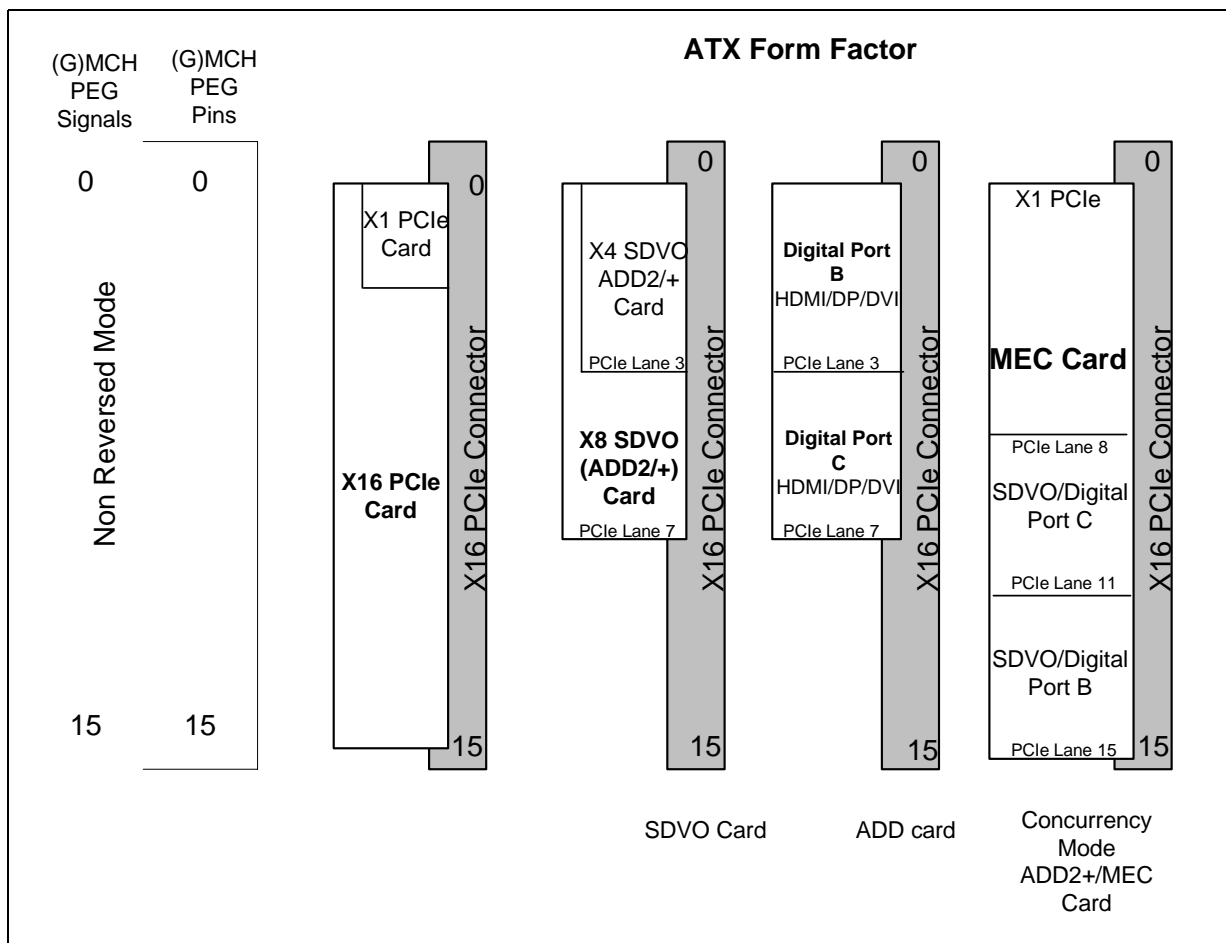
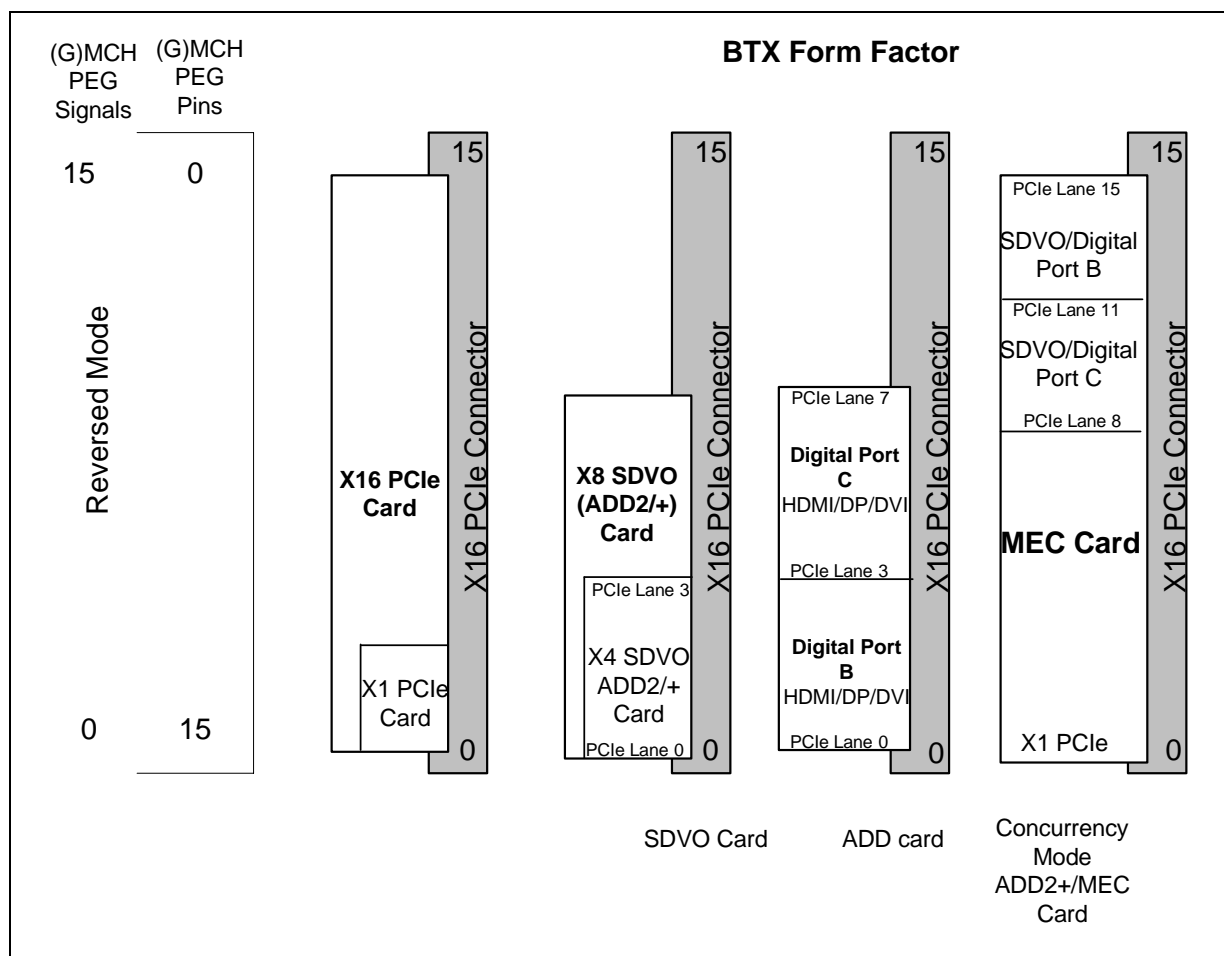



Figure 14. Display Configurations on Balanced Technology Extended (BTX) Platforms



13.5.2.7.2 TV-IN Capabilities

The GMCH, in conjunction with ADD2/MEDIA EXPANSION CARD, can function as a TV-Tuner card capable of taking in both analog or HD signals.

13.5.2.7.3 Analog Content Protection

Analog content protection will be provided through the external encoder using Macrovision 7.01. DVD software. It must verify the presence of a Macrovision TV encoder before playback continues. Simple attempts to disable the Macrovision operation must be detected.

13.5.2.7.4 Connectors

Target TV connectors support HDMI. The external TV encoder in use will determine the method of support.

13.5.2.7.5 Control Bus

Communication to SDVO registers (and if used, ADD2/MEC PROMs and monitor DDCs) is accomplished by using the SDVO_CTRLDATA and SDVO_CTRLCLK signals through the SDVO device. These signals run up to 1 MHz and connect directly to the SDVO



device. The SDVO device is then responsible for routing the DDC and PROM data streams to the appropriate location. Consult SDVO device datasheets for level shifting requirements of these signals.

13.5.2.7.6 Intel® SDVO Modes

The port can be dynamically configured in several modes:

- **Standard** – Baseline SDVO functionality. This mode supports Pixel Rates between 25 and 200 MP/s. The mode uses three data pairs to transfer RGB data.
- **Dual Standard** – This mode uses standard data streams across both SDVOB and SDVOC. Both channels can only run in Standard mode (3 data pairs) and each channel supports Pixel Rates between 25 MP/s and 200 MP/s.
 - **Dual Independent Standard** – In Dual Independent Standard mode, each SDVO channel will transmit a different pixel stream. The data stream across SDVOB will not be the same as the data stream across SDVOC.
 - **Dual Simultaneous Standard** – In Dual Simultaneous Standard mode, both SDVO channels will transmit the same pixel stream. The data stream across SDVOB will be the same as the data stream across SDVOC. The display timings will be identical, but the transfer timings may not be (i.e., SDVOB Clocks and Data may not be perfectly aligned with SDVOC Clock and Data as seen at the SDVO device(s)). Since this uses just a single data stream, it uses a single pixel pipeline in the GMCH.

13.5.3 Multiple Display Configurations

Microsoft Windows* 2000, Windows* XP, and Windows* Vista operating systems provide support for multi-monitor display. Since the GMCH has several display ports available for its two pipes, it can support up to two different images on different display devices. Timings and resolutions for these two images may be different. The GMCH supports Dual Display Clone, Dual Display Twin, and Extended Desktop.

Dual Display Clone uses both display pipes to drive the same content, at the same resolution and color depth to two different displays. This configuration allows for different refresh rates on each display.

Dual Display Twin uses one of the display pipes to drive the same content, at the same resolution, color depth, and refresh rates to two different displays.

Extended Desktop uses both display pipes to drive different content, at potentially different resolutions, refresh rates, and color depths to two different displays. This configuration allows for a larger Windows Desktop by using both displays as a work surface.

Note: The GMCH does not operate in parallel with an external PCI Express graphics device. The GMCH can, however, work in conjunction with a PCI graphics adapter.

13.5.3.1 High Bandwidth Digital Content Protection (HDCP)

The GMCH is the first desktop chipset with integrated HDCP keys. HDCP protection is required to drive high definition content over the digital display. HDCP is supported on both the digital ports B and C, but not simultaneously.

The GMCH supports HDCP over HDMI, Display Port and DVI display technologies. HDCP key integration reduces the effort and resources of key handling and key buying at the customer end.



13.6 Intel® Virtualization Technology for I/O Devices (Intel® 82Q45 GMCH Only)

13.6.1 Overview

For the Intel 4 Series Chipsets, the key Intel Virtualization Technology for I/O devices (device of virtualization) objectives are domain based isolation and virtualization. A domain can be abstractly defined as an isolated environment in a platform to which a subset of host physical memory is allocated. Virtualization allows for the creation of one or more partitions on a single system. This could be multiple partitions in the same OS or there can be multiple operating system instances running on the same system offering benefits such as system consolidation, legacy migration, activity partitioning, or security. Currently, the GMCH supports two partition approaches as shown in the EIT usage model (see Figure 15).

13.6.2 Embedded IT Client Usage Model

Figure 15. Example of EIT Usage Model

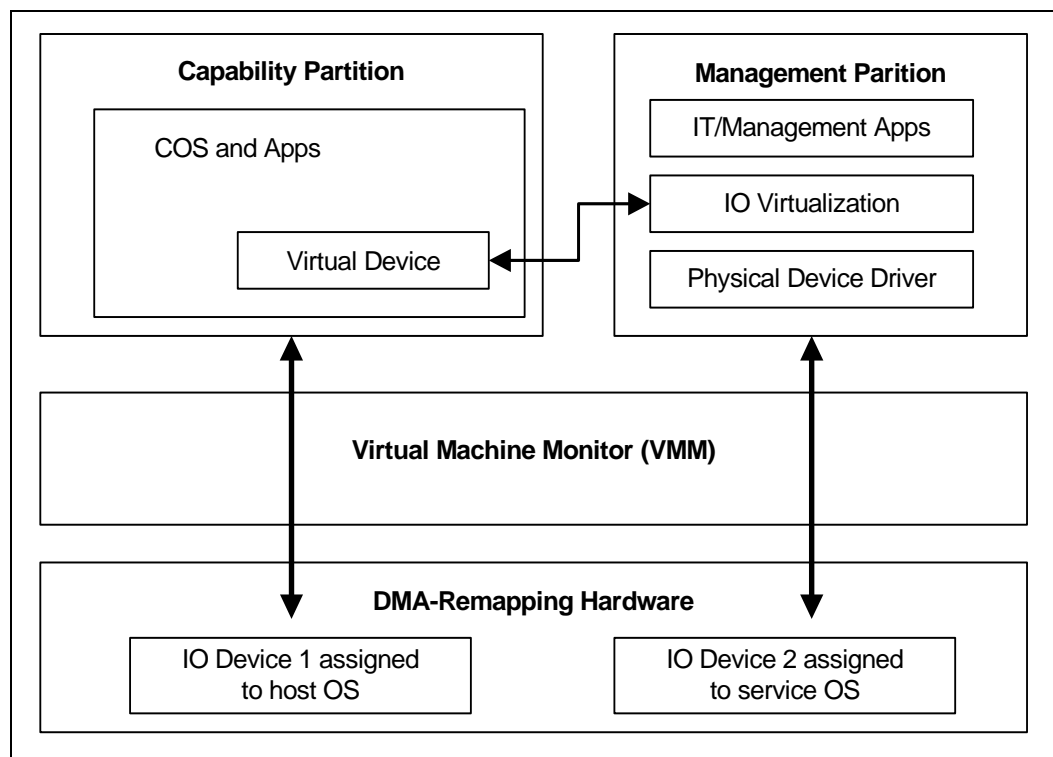

Figure 15 shows two different host partitions.

- Capability VM runs host OS Management. VM runs IT/management applications. Virtual partition hidden from the user.
- A VMM is introduced to virtualized BIOS and other system components to the OS.
- DMA remap engine exists in hardware for on-the-fly address translations.



13.6.2.1 Intel Virtualization Technology for I/O Devices Enables

- Multiple containers (silos) or domains run on a single hardware platform, fully isolated from each other. Dedicated hardware can be assigned to each container. Address space remap prevents hardware from accessing space outside its memory allocation.
- Flexible memory management by VMM.
- Un-modified device drivers to run in both partitions.
- Contain DMA errors across partitions.
- Allows enforcement of independent security policies for each partition.

13.6.2.2 Hardware Versus Software Virtualization

- Though software-only approach for I/O device management provides a few advantages like easier VM mobility across physical machines, this approach has some serious limitations.

13.6.2.3 Hardware Virtualization Advantages

- Hardware or device virtualization doesn't cause any changes to guest OS.
- No hardware functionality lost in virtual driver interface.
- VMM can be small since minimal drivers needed, thereby avoiding significant processor utilization overhead, and hence increases system performance.
- Hardware approach provides more robust memory protection as described earlier.

13.6.3 Concept of DMA Address Remapping

This section describes the hardware architecture concepts of DMA remapping.

The DMA-remapping architecture facilitates flexible assignment of I/O devices to an arbitrary number of domains. Each domain has a view of physical address space that may be different than the host physical address space. DMA-remapping treats the address specified in DMA requests as DMA virtual addresses (DVA). Depending on the software usage model, the DMA virtual address space may be the same as the guest-physical address (GPA) space of the domain to which the I/O device is assigned, or a purely virtual address space defined by software. In either case, DMA-remapping provides the transformation of address in a DMA request issued by an I/O device to its corresponding host-physical address (HPA).

For simplicity, the rest of the document describes the input address to the DMA-remapping hardware as GPA. [Figure 16](#) illustrates the I/O physical address translation. I/O devices 1 and 2 are assigned to domains 1 and 2 respectively. The software responsible for creating and managing the domains allocates system physical memory for both domains and sets up the DMA address translation function. GPA in DMA requests initiated by devices 1 and 2 are translated to appropriate HPAs by the DMA remapping hardware.

Figure 16. DMA Address Translation

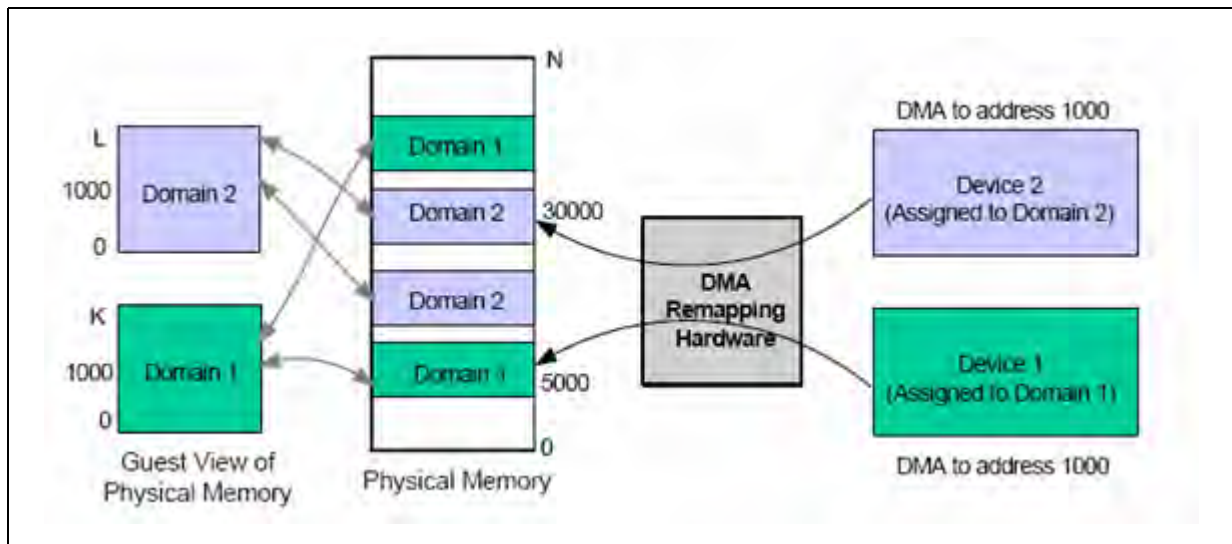

13.7 Intel[®] Trusted Execution Technology (Intel[®] TXT) (Intel[®] 82Q45 and 82Q43 GMCH Only)

Trusted Execution Technology (TXT) is a security initiative that involves the processor, chipset, and platform. Trusted Execution Technology requires the following support in the chipset:

- New FSB encodings for LTMW and LTMR cycles
- Measured launch of a VMM, using a TPM
- Protected path from the processor to the TPM, which is enabled by the processor
- Ranges of memory protected from DMA accesses.

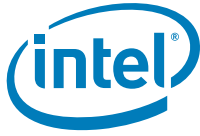

13.8 Intel® Management Engine (ME) Subsystem

The platform implements an Intel Management Engine (Intel ME) subsystem to provide Intel® Active Management Technology (Intel AMT) functionality. This ME was implemented using a scaleable architecture. The ME subsystem consists of a microcontroller, memory controller, and various I/O components spread across the (G)MCH and ICH I/O controller.

ME has a low pin count, low power private communication link - Controller Link (CLink) - that connects the ME-(G)MCH and ME-ICH functional logic. The CLink for the ME subsystem is analogous to DMI for the host subsystem.

The manageability engine is a low power execution engine that provides hardware for partitioned and/or secured firmware. The usage models for ME are in the Manageability of the Platform (i.e., Intel QST, Intel TPM, and ASF functionality, Alerting, Communications with Network in case of OS absent state, etc.)

13.8.1 ME Host Visible Functional Blocks

The ME subsystem contains various I/O and logic which is internal to ME functionality. Additionally, it also contains Host visible PCI functions making it a multi-function PCI device. The following are the host visible functions

HECI (Host Manageability Engine Communication Interface): HECI provides an interface for host software and ME firmware communication. It allows for communication between the Host processor based driver and Firmware that is running in the ME. There are 2 HECI functions inside the ME subsystem with their independent register space.

PT-IO (Proactive Technology IO): This block provides functionality for the core of Intel AMT in host operating system absent state. It exposes two functions to host software:

- **IDE-R (IDE redirection):** IDE-R function exposes a standard IDE device to the Host based driver. Usage for this function is to allow the client machine with ME enabled to transfer data back and forth between the Client and the console which is on the Network. Typical usage model is remote boot.
- **KT (Keyboard Text Redirection):** KT function exposes an UART register set to the ME Host. This allows the client to have a 2-way communication between the Client with ME enabled and the Console over the Network. Typical usage is to send text to a remote console and receive remote console keystrokes.



13.8.2 ME Power States

ME power states and Host/ME state combinations are described in the following tables.

| MState | Description |
|--------|-------------------------------------------------------------------------------------------|
| Moff | ME off |
| M1 | ME is running at slow speed, using its own memory controller which can access ch0 memory. |
| M0 | ME is running at full speed using the host memory controller to access UMA. |

Table 37. Host/ME State Combinations

| Given Host State | Allowable ME states |
|------------------|---------------------|
| S0 | M0, M0ff |
| S3, S4, S5 | M1, M0ff |

13.8.3 Host/ME State Transitions

Scenario 1: S5/Moff (G3) to S0/M0

- BIOS detects memory and initializes system memory controller
- ME waits for BIOS message before moving from M0ff to M0
- BIOS sends ME information about the DIMMs, which ME stores into flash

Scenario 2: S(x)/M1 to S0/M0

- BIOS asks already running ME to recover DIMM timing parameters from flash
- BIOS initializes host memory controller
- BIOS notifies ME that high performance memory is available and it transitions from M1 to M0

Scenario 3: S(x)/Moff to Sx/M1

- After initial boot (S5/Moff to S0/M0), memory configuration is saved in flash
- Wake event triggers switch to Sx/M1
- Memory configuration loaded and BSEL information supplied to clock chip
- Transition takes place



13.9 Thermal Sensor

There are several registers that need to be configured to support the (G)MCH thermal sensor functionality and SMI# generation. Customers must enable the Catastrophic Trip Point as protection for the (G)MCH. If the Catastrophic Trip Point is crossed, then the (G)MCH will instantly turn off all clocks inside the device. Customers may optionally enable the Hot Trip Point to generate SMI#. Customers will be required to then write their own SMI# handler in BIOS that will speed up the (G)MCH (or system) fan to cool the part.

13.9.1 PCI Device 0, Function 0

The SMICMD register requires that a bit be set to generate an SMI# when the Hot Trip point is crossed. The ERRSTS register can be inspected for the SMI alert.

| Address | Register Symbol | Register Name | Default Value | Access |
|---------|-----------------|---------------|---------------|-----------|
| C8–C9h | ERRSTS | Error Status | 0000h | RWC/S, RO |
| CC–CDh | SMICMD | SMI Command | 0000h | RO, R/W |

13.9.2 GMCHBAR Thermal Sensor Registers

The Digital Thermometer Configuration Registers reside in the MCHBAR configuration space.

| Address | Register Symbol | Register Name | Default Value | Access |
|----------|-----------------|---------------------------------------|---------------|-------------------|
| CD8–CD8h | TSC1 | Thermal Sensor Control 1 | 00h | RW/L, R/W, RS/WC |
| CD9–CD9h | TSC2 | Thermal Sensor Control 2 | 00h | RO, RW/L |
| CDA–CDAh | TSS | Thermal Sensor Status | 00h | RO |
| CDC–CDFh | TSTTP | Thermal Sensor Temperature Trip Point | 00000000h | RO, RW, R/W/L |
| CE2–CE2h | TCO | Thermal Calibration Offset | 00h | RW/L/K, R/W/L |
| CE4–CE4h | THERM1 | Hardware Throttle Control | 00h | RW/L, RO, R/W/L/K |
| CE6–CE6h | THERM3 | TCO Fuses | 00h | RO, RS/WC |
| CEA–CEBh | TIS | Thermal Interrupt Status | 0000h | RO, R/WC |
| CF1–CF1h | TSMICMD | Thermal SMI Command | 00h | RO, R/W |



13.10 Power Management

The (G)MCH has many permutations of possibly concurrently operating modes. Obviously, care should be taken (Hardware and Software) to disable unused sections of the silicon when this can be done with sufficiently low performance impact.

Refer to the *ACPI Specification, Revision 3.0* for an overview of the system power states mentioned in this section.

13.10.1 Main memory Power Management

Table 38. Targeted Memory State Conditions

| Mode | Memory State with Internal Graphics | Memory State with External Graphics |
|------------|-------------------------------------------------------------------------------------------------------------------------------------------------------------------------------------------------------------------------------------------------|---------------------------------------------------------------------------------------------------------------------------------------------------------------------------------------------|
| C0, C1, C2 | Dynamic memory rank power down based on idle conditions | Dynamic memory rank power down based on idle conditions |
| C3, C4 | Dynamic memory rank power down based on idle conditions If graphics engine is idle, no display requests, and permitted display configuration, then enter self-refresh. Otherwise use dynamic memory rank power down based on idle conditions | Dynamic memory rank power down based on idle conditions If there are no memory requests, then enter self-refresh. Otherwise, use dynamic memory rank power down based on idle conditions |
| S3 | Self Refresh Mode | Self Refresh Mode |
| S4 | Memory power down (contents lost) | Memory power down (contents lost) |

This section details the support provided by the (G)MCH corresponding to the various processor/Display/System ACPI states. Descriptions provided in this section should be used in [Section 13.10.3](#).

Table 39. Platform System States

| State | Description |
|------------|------------------------------------------------------------------------------------------------------------------------------|
| G0/S0 | Full On |
| G1/S1 | Stop Clock. Clock to processor still running. Clock stopped to processor core. Processor thread synchronization not required |
| G1/S3-Cold | Suspend to RAM (STR). Context saved to memory (S3-Hot is not supported by the (G)MCH) |
| G1/S4 | Suspend to Disk (STD). All power lost (except wakeup on ICH) |
| G2/S5 | Soft off. All power lost (except wakeup on ICH). Total reboot |
| G3 | Hard off. All power (AC and battery) removed from system |

**Table 40. Processor Power States**

| State | Description |
|--------|---------------------------------------------------------------------------------------------------------------------------|
| C0 | Full On |
| C1/C1E | Auto Halt |
| C2/C2E | Stop Clock. Clock to processor still running. Clock stopped to processor core. Processor thread synchronization required. |
| C3 | Deep Sleep. Clock to processor stopped |
| C4/C4E | Deeper Sleep. Same as C3 with reduced voltage on the processor |

Table 41. Internal Graphics Display Device Control

| State | Description |
|-------|--------------------------------------------------------|
| D0 | Display Active |
| D1 | Low power state, low latency recovery, Standby display |
| D2 | Suspend display |
| D3 | power-off display |

13.10.2 Interface Power States Supported

Table 42. PCI Express Link States

| State | Description |
|-------|------------------------------------------------------|
| L0 | Full on – Active transfer state |
| L1 | Lowest Active Power Management - Longer exit latency |

Table 43. Main Memory States

| State | Description |
|-----------------------|-------------------------------------------------------------|
| Power up | CKE asserted. Active mode |
| Pre-charge Power down | CKE deasserted (not self-refresh) with all banks closed |
| Active Power down | CKE deasserted (not self-refresh) with min. one bank active |
| Self-Refresh | CKE deasserted using device self-refresh |



13.10.3 Chipset State Combinations

(G)MCH supports the state combinations listed in the Table 44.

Table 44. G, S, and C State Combinations

| Global (G) State | Sleep (S) State | Processor (C) State | Processor State | System Clocks | Description |
|------------------|-----------------|---------------------|-----------------------------------------------|-----------------|--------------------------------------------|
| G0 | S0 | C0 | Full On | On | Full On |
| G0 | S0 | C1 | Auto-Halt | On | Auto Halt |
| G0 | S0 | C2 | Stop Grant | On | Stop Grant |
| G1 | S0 | C3 | Deep Sleep, Clock to processor Stopped | On | Deep Sleep |
| G1 | S0 | C4 | Deeper Sleep Reduced voltage on the processor | On | Deep Sleep with processor voltage lowered. |
| G1 | S3 | power-off | — | Off, except RTC | Suspend to RAM |
| G1 | S4 | power-off | — | Off, except RTC | Suspend to Disk |
| G2 | S5 | power-off | — | Off, except RTC | Soft Off |
| G3 | NA | power-off | — | power-off | Hard Off |

Table 45. Interface Activity to State Mapping

| ACPI State/ Feature | C0/C1/C2 | C3/C4 | S1 | S3 | S4, S5 |
|-----------------------------------------------------|-------------------------------------------------------------------------------|-------------------------------------------------------------------------------|-------------------------------------------------------------------------------|----------------------------------------------------------------------|-----------------------|
| DRAM | On (with power saving features) | Self-refresh (with this power saving feature enabled) | On (with power saving features) | Self-refresh for non-ME channel. Other channel is ME state dependent | Depending on ME state |
| GTL Control, Data, Address Buffer Sense Amp Disable | No Dynamic disabling of data bus sense amps, dynamic transmit clock gating | No Dynamic disabling of data bus sense amps, dynamic transmit clock gating | No Dynamic disabling of data bus sense amps, dynamic transmit clock gating | On | Auto Halt |
| PCI Express State | L0/L1 (ASPM) | L0/L1 (ASPM) | L0/L1 (ASPM) | Power Off | Power Off |
| DMI Interface | L0/L1 (ASPM) | L0/L1 (ASPM) | L0/L1 (ASPM) | Power Off | Power Off |
| HPLL | Running | Running | Running | Depending on ME State | Depending on ME State |



Table 45. Interface Activity to State Mapping

| ACPI State/ Feature | C0/C1/C2 | C3/C4 | S1 | S3 | S4, S5 |
|-----------------------------|----------------------------------------------------|----------------------------------------------------|----------------------------------------------------|-----------------------|-----------------------|
| PCI Express PLL | Running | Running | Running | Power Off | Power Off |
| DPLL A & B | Running when corresponding display pipe is enabled | Running when corresponding display pipe is enabled | Running when corresponding display pipe is enabled | Power Off | Power Off |
| FSB, DMI, PCI Express RCOMP | Running | Running | Running | Power Off | Power Off |
| Thermal Sensor | Yes | Yes | Yes | Depending on ME state | Depending on ME state |
| (G)MCH Core Power | On | On | On | Off | Off |
| Mem RCOMP | Running | Running (Bypass mode) | Running | Depending on ME state | Depending on ME state |



13.11 Clocking

The (G)MCH has a total of 5 PLLs providing many times that many internal clocks. The PLLs are:

- Host PLL – Generates the main core clocks in the host clock domain. Can also be used to generate memory and internal graphics core clocks. Uses the Host clock (H_CLKIN) as a reference.
- Memory I/O PLL - Optionally generates low jitter clocks for memory I/O interface, as opposed to from Host PLL. Uses the Host FSB differential clock (HPL_CLKINP/ HPL_CLKINN) as a reference. Low jitter clock source from memory I/O PLL is required for DDR667 and higher frequencies.
- PCI Express PLL – Generates all PCI Express related clocks, including the Direct Media that connect to the ICH. This PLL uses the 100 MHz clock (EXP_CLKNP/ EXP2_CLKNP) as a reference. Display PLL A – Generates the internal clocks for Display A. Uses D_REFCLKIN as a reference.
- Display PLL B – Generates the internal clocks for Display B. Also uses D_REFCLKIN as a reference.

CK505 is the clocking chip required for the platform.



14 Electrical Characteristics

This chapter provides the absolute maximum ratings, current consumption, and DC characteristics.

14.1 Absolute Minimum and Maximum Ratings

Table 46 specifies the Intel® 4 Series Chipset absolute maximum and minimum ratings. Within functional operation limits, functionality and long-term reliability can be expected.

At conditions outside functional operation condition limits, but within absolute maximum and minimum ratings, neither functionality nor long-term reliability can be expected. If a device is returned to conditions within functional operation limits after having been subjected to conditions outside these limits, but within the absolute maximum and minimum ratings, the device may be functional, but with its lifetime degraded depending on exposure to conditions exceeding the functional operation condition limits.

At conditions exceeding absolute maximum and minimum ratings, neither functionality nor long-term reliability can be expected. Moreover, if a device is subjected to these conditions for any length of time its reliability will be severely degraded or not function when returned to conditions within the functional operating condition limits.

Although the (G)MCH contains protective circuitry to resist damage from static electric discharge, precautions should always be taken to avoid high static voltages or electric fields.

Table 46. Absolute Minimum and Maximum Ratings

| Symbol | Parameter | Min | Max | Unit | Notes |
|------------------------------------------------------------------------------|--------------------------------------------------------------------------------------|------|------|------|--------------|
| T _{storage} | Storage Temperature | -55 | 150 | °C | ¹ |
| (G)MCH Core | | | | | |
| VCC (Intel 82P45, 82P43, 82Q45, 82Q43, 82B43, 82G41 (G)MCH Only) | 1.1 V Core Supply Voltage with respect to V _{SS} | -0.3 | 1.21 | V | |
| VCC (Intel® 82G45, 82G43 GMCH Only) | 1.125 V Core Supply Voltage with respect to V _{SS} | -0.3 | 1.21 | V | |
| Host Interface (800/1066/1333 MHz) | | | | | |
| VTT_FSB | System Bus Input Voltage with respect to V _{SS} | -0.3 | 1.32 | V | |
| VCCA_HPLL | 1.1 V Host PLL Analog Supply Voltage with respect to V _{SS} | -0.3 | 1.21 | V | |
| System Memory Interface (DDR2 667/800 MHz, DDR3 800/1066 MHz) | | | | | |
| VCC_DDR | 1.8 V DDR2 / 1.5 V DDR3 System Memory Supply Voltage with respect to V _{SS} | -0.3 | 4.0 | V | |

Table 46. Absolute Minimum and Maximum Ratings

| Symbol | Parameter | Min | Max | Unit | Notes |
|-------------------------------------------------------------------------|-------------------------------------------------------------------------------------|------|------|------|-------|
| VCC_CKDDR | 1.8 V DDR2 / 1.5 V DDR3 Clock System Memory Supply Voltage with respect to V_{SS} | -0.3 | 4.0 | V | |
| VCCA_MPLL | 1.1 V System Memory PLL Analog Supply Voltage with respect to V_{SS} | -0.3 | 1.21 | V | |
| PCI Express* / Intel® sDVO / DMI / HDMI / DVI /DP Interface | | | | | |
| VCC_EXP (Intel 82P45, 82P43, 82Q45, 82Q43, 82B43, 82G41 (G)MCH Only) | 1.1 V PCI Express* and DMI Supply Voltage with respect to V_{SS} | -0.3 | 1.21 | V | |
| VCC_EXP (Intel 82G45, 82G43 (G)MCH Only) | 1.125 V PCI Express* and DMI Supply Voltage with respect to V_{SS} | -0.3 | 1.21 | V | |
| VCCA_EXP | 1.5 V PCI Express* Analog Supply Voltage with respect to V_{SS} | -0.3 | 1.65 | V | |
| VCCAPLL_EXP | 1.1 V PCI Express* PLL Analog Supply Voltage with respect to V_{SS} | -0.3 | 1.21 | V | |
| R, G, B / CRT DAC Display Interface (8 bit) | | | | | |
| VCCA_DAC | 3.3 V Display DAC Analog Supply Voltage with respect to V_{SS} | -0.3 | 3.63 | V | |
| VCCDQ_CRT | 1.5 V Display DAC Quiet Digital Supply Voltage with respect to V_{SS} | -0.3 | 1.65 | V | |
| VCCA_DPLLA | 1.1 V Display PLL A Analog Supply Voltage with respect to V_{SS} | -0.3 | 1.21 | V | |
| VCCA_DPLLB | 1.1 V Display PLL B Analog Supply Voltage with respect to V_{SS} | -0.3 | 1.21 | V | |
| Controller Link Interface | | | | | |
| VCC_CL | 1.1 V Supply Voltage with respect to V_{SS} | -0.3 | 1.21 | V | |
| CMOS Interface | | | | | |
| VCC3_3 | 3.3 V CMOS Supply Voltage with respect to V_{SS} | -0.3 | 3.63 | V | |

NOTES:

1. Possible damage to the (G)MCH may occur if the (G)MCH temperature exceeds 150 °C. Intel does not ensure functionality for parts that have exceeded temperatures above 150 °C due to specification violation.

14.2 Current Consumption

Table 47 and Table 48 show the current consumption for the (G)MCH. I_{CC} values are provided for the worst case I_{CC} situations for each component of the (G)MCH.

- I_{CCMax} current values are defined as the theoretical maximum instantaneous current consumed while operating at V_{CC_Max} , T_{JMAX} and executing the worst case instruction mix.
- I_{CC} Sustained current values are defined as the maximum current consumed under TDP workload while operating at V_{CC_Max} , T_{JMax} and executing the worst case real application instruction mix. I_{CC} Sustained current values or Maximum current values cannot occur simultaneously on all interfaces.



- I_{CC} Idle current values are defined as the current consumed during idle state while operating at nominal V_{CC} and nominal temperature.

Table 47. Current Consumption in ACPI S0 State for Intel® 82G45, 82G43, 82B43, 82G41 GMCH, and 82P45, 82P43 MCH Components

| Symbol | Parameter | Signal Names | I_{CC} Sustained | | I_{CC} Max | | Unit | Notes |
|-------------------|----------------------------------------------------------------|--------------|--------------------|-------|--------------|--------|------|-------|
| | | | GMCH | MCH | GMCH | MCH | | |
| I_{VCC} | 1.1 V Core Supply Current (Discrete graphics) | VCC | N/A | 9.637 | N/A | 9.8402 | A | |
| I_{VCC} | 1.125 V Core Supply Current (Integrated graphics) | VCC | 14.162 | N/A | 17.984 | N/A | A | |
| I_{VCC_DDR2} | DDR2 System Memory Interface (1.8 V) Supply Current | VCC_DDR | 1.163 | 1.104 | 1.328 | 1.328 | A | |
| I_{VCC_CKDDR2} | DDR2 System Memory Clock Interface (1.8 V) Supply Current | VCC_CKDDR | 0.323 | 0.323 | 0.373 | 0.373 | A | |
| I_{VCC_DDR3} | DDR3 System Memory Interface (1.5 V) Supply Current | VCC_DDR | 0.899 | 0.640 | 1.963 | 1.9629 | A | |
| I_{VCC_CKDDR3} | DDR3 System Memory Clock Interface (1.5 V) Supply Current | VCC_CKDDR | 0.251 | 0.251 | 0.288 | 0.2881 | A | |
| I_{VCC_EXP} | 1.1 V PCI Express* / Intel® SDVO and DMI Supply Current | VCC_EXP | N/A | 3.082 | N/A | 3.0821 | A | 1 |
| I_{VCC_EXP} | 1.125 V PCI Express* / Intel® SDVO and DMI Supply Current | VCC_EXP | 1.345 | N/A | 1.345 | N/A | A | 1 |
| I_{VCC_CL} | 1.1 V Controller Supply Current | VCC_CL | 3.529 | 4.126 | 4.060 | 4.6667 | A | |
| I_{VTT_FSB} | System Bus Supply Current | VTT_FSB | 0.418 | 0.418 | 0.914 | 0.914 | A | |
| I_{VCCA_EXP} | 1.5 V PCI Express* / Intel® SDVO and DMI Analog Supply Current | VCCA_EXP | 0.006 | 0.006 | 0.006 | 0.006 | A | |
| I_{VCCA_DAC} | 3.3 V Display DAC Analog Supply Current | VCCA_DAC | 0.074 | 0.012 | 0.074 | 0.0116 | A | |
| I_{VCC3_3} | 3.3 V CMOS Supply Current | VCC3_3 | 0.014 | 0.014 | 0.014 | 0.014 | A | |
| I_{VCCDQ_CRT} | 1.5 V Display Quiet Digital Supply Current | VCCDQ_CRT | 0 | 0 | 0 | 0 | A | |

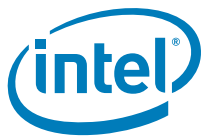

Table 47. Current Consumption in ACPI S0 State for Intel® 82G45, 82G43, 82B43, 82G41 GMCH, and 82P45, 82P43 MCH Components

| Symbol | Parameter | Signal Names | I _{CC} Sustained | | I _{CC} Max | | Unit | Notes |
|--------------------------|--------------------------------------------------------------------|--------------|---------------------------|-------|---------------------|--------|------|-------|
| | | | GMCH | MCH | GMCH | MCH | | |
| I _{VCCAPLL_EXP} | 1.1 V PCI Express* / Intel® SDVO and DMI PLL Analog Supply Current | VCCAPLL_EXP | 0.02 | 0.02 | 0.02 | 0.0201 | A | |
| I _{VCCA_HPLL} | 1.1 V Host PLL Supply Current | VCCA_HPLL | 0.031 | 0.031 | 0.031 | 0.0313 | A | |
| I _{VCCA_DPLLA} | 1.1 V Display PLL A Supply Current | VCCA_DPLLA | 0.059 | 0.007 | 0.059 | 0.007 | A | |
| I _{VCCA_DPLLB} | 1.1 V Display PLL B Supply Current | VCCA_DPLLB | 0.059 | 0.007 | 0.059 | 0.007 | A | |
| I _{VCCA_MPLL} | 1.1 V System Memory PLL Analog Supply Current | VCCA_MPLL | 0.083 | 0.083 | 0.083 | 0.083 | A | |

NOTES:

- The difference in current is due to different number of lanes. For the Intel 82P45 and 82P43 MCH, x16 lane width. For the 82G45, 82G43, 82G41, 82B43GMCH, x1 lane width.

Table 48. Current Consumption in ACPI S0 state for Intel® 82Q45 and 82Q43 Components

| Symbol | Parameter | Signal Names | I _{CC} Sustained | I _{CC} Max | I _{CC} Idle | Unit | Notes |
|-------------------------|-----------------------------------------------------------|--------------|---------------------------|---------------------|----------------------|------|-------|
| I _{VCC} | 1.1 V Core Supply Current (Integrated Graphics) | VCC | 11.8 | 15.4 | 2.078 | A | |
| I _{VCC_DDR2} | DDR2 System Memory Interface (1.8 V) Supply Current | VCC_DDR | 1.163 | 1.328 | 0.204 | A | |
| I _{VCC_CKDDR2} | DDR2 System Memory Clock Interface (1.8 V) Supply Current | VCC_CKDDR | 0.324 | 0.373 | 0.293 | A | |
| I _{VCC_DDR3} | DDR3 System Memory Interface (1.5 V) Supply Current | VCC_DDR | 0.879 | 1.571 | 0.130 | A | |
| I _{VCC_CKDDR3} | DDR3 System Memory Clock Interface (1.5 V) Supply Current | VCC_CKDDR | 0.223 | 0.257 | 0.179 | A | |
| I _{VCC_EXP} | 1.1 V PCI Express* / Intel® SDVO and DMI Supply Current | VCC_EXP | 1.345 | 1.345 | 0.196 | A | |
| I _{VCC_CL} | 1.1 V Controller Supply Current | VCC_CL | 2.491 | 3 | 1.822 | A | |
| I _{VTT_FSB} | System Bus Supply Current | VTT_FSB | 0.418 | 0.914 | N/A | A | |

Table 48. Current Consumption in ACPI S0 state for Intel® 82Q45 and 82Q43 Components

| Symbol | Parameter | Signal Names | I _{CC Sustained} | I _{CC Max} | I _{CC Idle} | Unit | Notes |
|--------------------------|--------------------------------------------------------------------|--------------|---------------------------|---------------------|----------------------|------|-------|
| I _{VCCA_EXP} | 1.5 V PCI Express* / Intel® SDVO and DMI Analog Supply Current | VCCA_EXP | 0.006 | 0.006 | N/A | A | |
| I _{VCCA_DAC} | 3.3 V Display DAC Analog Supply Current | VCCA_DAC | 0.074 | 0.074 | N/A | A | |
| I _{VCC3_3} | 3.3 V CMOS Supply Current | VCC3_3 | 0.014 | 0.014 | N/A | A | |
| I _{VCCDQ_CRT} | 1.5 V Display Quiet Digital Supply Current | VCCDQ_CRT | 0 | 0 | N/A | A | |
| I _{VCCAPLL_EXP} | 1.1 V PCI Express* / Intel® SDVO and DMI PLL Analog Supply Current | VCCAPLL_EXP | 0.02 | 0.02 | N/A | A | |
| I _{VCCA_HPLL} | 1.1 V Host PLL Supply Current | VCCA_HPLL | 0.031 | 0.031 | N/A | A | |
| I _{VCCA_DPLLA} | 1.1 V Display PLL A Supply Current | VCCA_DPLLA | 0.059 | 0.059 | N/A | A | |
| I _{VCCA_DPLLB} | 1.1 V Display PLL B Supply Current | VCCA_DPLLB | 0.059 | 0.059 | N/A | A | |
| I _{VCCA_MPLL} | 1.1 V System Memory PLL Analog Supply Current | VCCA_MPLL | 0.083 | 0.083 | N/A | A | |

Table 49 shows the maximum power consumption for the Intel 82Q45 GMCH in the ACPI S3, S4, and S5 states with Intel Active Management Technology support. Platforms that use Intel Active Management Technology will keep DRAM memory powered in S4 and S5. Current consumption used by the (G)MCH will vary between the "Idle" case and the "Max" case, depending on activity on the Intel Management Engine. For the majority of the time, the Intel Management Engine will be in the "Idle" state. It is unknown if commercial software management applications will be able to generate this level of power consumption

Table 49. Current Consumption in S3, S4, S5 with Intel® Active Management Technology Operation (Intel® 82Q45 GMCH Only)

| Symbol | Parameter | Signal Names | Idle | Max | Unit | Notes |
|----------------------------|--------------------------------------------------------------------------------------|--------------------|-------|-------|------|-------|
| I _{MCH_CL} | 1.1 V Supply Current for (G)MCH with Intel AMT | VCC_CL | 2.014 | 2.389 | A | |
| I _{DDR2_PLATFORM} | DDR2 System Memory Interface (1.8 V) Supply Current in Standby States with Intel AMT | VCC_DDR, VCC_CKDDR | 0.17 | 0.19 | A | |
| I _{DDR3_PLATFORM} | DDR3 System Memory Interface (1.5 V) Supply Current in Standby States with Intel AMT | VCC_DDR, VCC_CKDDR | 0.054 | 0.092 | A | |



14.3 (G)MCH Buffer Supply and DC Characteristics

14.3.1 I/O Buffer Supply Voltages

The I/O buffer supply voltage is measured at the (G)MCH package pins. The tolerances shown in Table 50 are inclusive of all noise from DC up to 20 MHz. In the lab, the voltage rails should be measured with a bandwidth limited oscilloscope with a roll off of 3 dB/decade above 20 MHz under all operating conditions.

Table 50 indicates which supplies are connected directly to a voltage regulator or to a filtered voltage rail. For voltages that are connected to a filter, they should be measured at the input of the filter.

If the recommended platform decoupling guidelines cannot be met, the system designer will have to make tradeoffs between the voltage regulator output DC tolerance and the decoupling performance of the capacitor network to stay within the voltage tolerances listed in Table 50.

Table 50. I/O Buffer Supply Voltage

| Symbol | Parameter | Min | Nom | Max | Unit | Notes |
|------------------------------------------------------------------------------|------------------------------------------|-------|-------|-------|------|-------|
| VCC_DDR | DDR2 I/O Supply Voltage | 1.71 | 1.8 | 1.89 | V | |
| | DDR3 I/O Supply Voltage | 1.425 | 1.5 | 1.575 | V | |
| VCC_CKDDR | DDR2 Clock Supply Voltage | 1.71 | 1.8 | 1.89 | V | 3 |
| | DDR3 Clock Supply Voltage | 1.425 | 1.5 | 1.575 | V | |
| VCC_EXP (Intel 82P45, 82P43, 82Q45, 82Q43, 82B43, 82G41 GMCH) | SDVO, PCI Express* Supply Voltage | 1.045 | 1.1 | 1.155 | V | |
| VCC_EXP (Intel 82G45, 82G43 GMCH) | SDVO, PCI Express* Supply Voltage | 1.095 | 1.125 | 1.155 | V | |
| VCCA_EXP | SDVO, PCI Express* Analog Supply Voltage | 1.425 | 1.5 | 1.575 | V | 3 |
| VTT_FSB | 1.2 V System Bus Input Supply Voltage | 1.14 | 1.2 | 1.26 | V | |
| VCC (Intel 82P45, 82P43 MCH, 82Q45, 82Q43, 82B43, 82G41 GMCH) | (G)MCH Core Supply Voltage | 1.045 | 1.1 | 1.155 | V | |
| VCC (Intel 82G45, 82G43 GMCH) | GMCH Core Supply Voltage | 1.095 | 1.125 | 1.155 | V | |
| VCC_CL | Controller Supply Voltage | 1.045 | 1.1 | 1.155 | V | |
| VCC3_3 | CMOS Supply Voltage | 3.135 | 3.3 | 3.465 | V | |

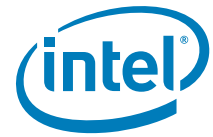

Table 50. I/O Buffer Supply Voltage

| Symbol | Parameter | Min | Nom | Max | Unit | Notes |
|-----------------------------------------------------------------------------------------------------|--------------------------------------|-------|-----|-------|------|-------|
| VCCA_DAC | Display DAC Analog Supply Voltage | 3.135 | 3.3 | 3.465 | V | 1 |
| VCCDQ_CRT | Display Quiet Digital Supply Voltage | 1.425 | 1.5 | 1.575 | V | 2 |
| VCCAPLL_EXP, VCCDPPL_EXP, VCCA_DPLLA, VCCA_DPLLB, VCCA_HPLL, VCCD_HPLL, VCCA_MPLL | Various PLL's Analog Supply Voltages | 1.045 | 1.1 | 1.155 | V | 3, 4 |

NOTES:

- VCCA_DAC voltage tolerance should only be measured when the DAC is turned ON and at a stable resolution setting. Any noise on the DAC during power on or display resolution changes do not impact the circuit.
- The VCCDQ_CRT can also operate at a nominal 1.8 V \pm 5% input voltage. Only the 1.5 V nominal voltage setting will be validated internally.
- These rails are filtered from other voltage rails on the platform and should be measured at the input of the filter.
- The noise specifications for VCCA_DPLLA, VCCA_DPPLB, VCCA_HPLL, VCCD_HPLL and VCCA_MPLL are 50, 50, 70, 70 and 70 respectively in mVpp.



14.3.2 General DC Characteristics

Platform Reference Voltages at the top of Table 51 are specified at DC only. V_{REF} measurements should be made with respect to the supply voltage.

Table 51. DC Characteristics

| Symbol | Parameter | Min | Nom | Max | Unit | Notes |
|-------------------------------------|----------------------------------------------------------------|--------------------------------------|------------------------------|--------------------------------------------------|---------|----------------------------------|
| Reference Voltages | | | | | | |
| FSB_DVREF FSB_ACCVREF | Host Data, Address, and Common Clock Signal Reference Voltages | $0.635 \times V_{TT_FSB} - 2\%$ | $0.635 \times V_{TT_FSB}$ | $0.635 \times V_{TT_FSB} + 2\%$ | V | |
| FSB_SWING | Host Compensation Reference Voltage | $0.25 \times V_{TT_FSB} - 2\%$ | $0.25 \times V_{TT_FSB}$ | $0.25 \times V_{TT_FSB} + 2\%$ | V | |
| CL_VREF | Controller Link Reference Voltage | 0.3325 | 0.35 | 0.3675 | V | |
| DDR_VREF | DDR2 Reference Voltage | 0.85 | 0.9 | 0.95 | V | |
| DDR_VREF | DDR3 Reference Voltage | 0.70 | 0.75 | 0.80 | V | |
| Host Interface | | | | | | |
| V_{IL_H} | Host GTL+ Input Low Voltage | -0.072 | 0 | $(0.635 \times V_{TT_FSB}) - 0.072$ | V | |
| V_{IH_H} | Host GTL+ Input High Voltage | $(0.635 \times V_{TT_FSB}) + 0.072$ | V_{TT_FSB} | $V_{TT_FSB} + 0.072$ | V | |
| V_{OL_H} | Host GTL+ Output Low Voltage | — | — | $(0.25 \times V_{TT_FSB}) + 0.072$ | V | |
| V_{OH_H} | Host GTL+ Output High Voltage | $V_{TT_FSB} - 0.072$ | — | V_{TT_FSB} | V | |
| I_{OL_H} | Host GTL+ Output Low Current | — | — | $V_{TT_FSBmax} \times (1 - 0.25) / R_{ttmin}$ * | mA | $R_{ttmin} = 47.5 \Omega$ |
| I_{LEAK_H} | Host GTL+ Input Leakage Current | — | — | TBD | μA | $V_{OL} < V_{pad} < V_{TT_FSB}$ |
| C_{PAD} | Host GTL+ Input Capacitance | 1.5 | — | 2.5 | pF | |
| C_{PKG} | Host GTL+ Input Capacitance (common clock) | TBD | — | TBD | pF | |
| DDR2 System Memory Interface | | | | | | |
| $V_{IL(DC)}$ | DDR2 Input Low Voltage | $DDR_VREF - 100 \text{ mV}$ | $DDR_VREF - 100 \text{ mV}$ | $DDR_VREF - 100 \text{ mV}$ | V | |
| $V_{IH(DC)}$ | DDR2 Input High Voltage | $DDR_VREF + 100 \text{ mV}$ | $DDR_VREF + 100 \text{ mV}$ | $DDR_VREF + 100 \text{ mV}$ | V | |
| $V_{IL(AC)}$ | DDR2 Input Low Voltage | $DDR_VREF - 125 \text{ mV}$ | $DDR_VREF - 125 \text{ mV}$ | $DDR_VREF - 125 \text{ mV}$ | V | |
| $V_{IH(AC)}$ | DDR2 Input High Voltage | $DDR_VREF + 125 \text{ mV}$ | $DDR_VREF + 125 \text{ mV}$ | $DDR_VREF + 125 \text{ mV}$ | V | |
| V_{OL} | DDR2 Output Low Voltage | 0.6 | 0.64 | 0.67 | V | 1 |



Table 51. DC Characteristics

| Symbol | Parameter | Min | Nom | Max | Unit | Notes |
|-------------------------------------------------------------------------------------------------|---------------------------------------------------|----------------------|----------------------|---------------------------|------|---------|
| V _{OH} | DDR2 Output High Voltage | 1.45 | 1.54 | 1.62 | V | 1 |
| I _{Leak} | Input Leakage Current | <0.1 | <0.1 | <0.1 | μA | 2 |
| I _{Leak} | Input Leakage Current | <0.1 | <0.1 | <0.1 | μA | 3 |
| C _{I/O} | DQ/DQS/DQSB DDR2 Input/ Output Pin Capacitance | 2.3 | 2.3 | 2.3 | pF | |
| DDR3 System Memory Interface | | | | | | |
| V _{IL(DC)} | DDR3 Input Low Voltage | DDR_VREF – 100 mV | DDR_VREF – 100 mV | DDR_VREF – 100 mV | V | |
| V _{IH(DC)} | DDR3 Input High Voltage | DDR_VREF + 100 mV | DDR_VREF + 100 mV | DDR_VREF + 100 mV | V | |
| V _{IL(AC)} | DDR3 Input Low Voltage | DDR_VREF – 125 mV | DDR_VREF – 125 mV | DDR_VREF – 125 mV | V | |
| V _{IH(AC)} | DDR3 Input High Voltage | DDR_VREF + 125 mV | DDR_VREF + 125 mV | DDR_VREF + 125 mV | V | |
| V _{OL} | DDR3 Output Low Voltage | 0.6 | 0.64 | 0.67 | V | 1 |
| V _{OH} | DDR3 Output High Voltage | 1.45 | 1.52 | 1.62 | V | 1 |
| I _{Leak} | Input Leakage Current | <0.1 | <0.1 | <0.1 | μA | 2 |
| I _{Leak} | Input Leakage Current | <0.1 | <0.1 | <0.1 | μA | 3 |
| C _{I/O} | DQ/DQS/DQSB DDR3 Input/ Output Pin Capacitance | 2.3 | 2.3 | 2.3 | pF | |
| 1.1 V PCI Express* Interface 2.0 (includes PCI Express* / Intel® sDVO / DVI / HDMI / DP) | | | | | | |
| V _{TX-DIFF P-P} | Differential Peak to Peak Output Voltage | 0.8 | 1.0 | 1.2 | V | 4 |
| V _{TX_CM-ACp} | AC Peak Common Mode Output Voltage | — | — | 60 | mV | |
| Z _{TX-DIFF-DC} | DC Differential TX Impedance | 80 | 100 | 120 | ? | |
| V _{RX-DIFF P-P} | Differential Peak to Peak Input Voltage | 0.175 | — | 1.2 | V | 5 |
| V _{RX_CM-ACp} | AC Peak Common Mode Input Voltage | — | — | 75@2.5 GHz 300@100 MHz | mV | |
| HPD (Hot Plug Detect) | | | | | | |
| V _{IL} | Input Low Voltage | — | — | 200 | mV | |
| V _{IH} | Input High Voltage | 600 | — | — | mV | |
| Input Clocks | | | | | | |
| V _{IL} | Input Low Voltage | -0.30 | 0 | — | V | |
| V _{IH} | Input High Voltage | — | — | 1.15 | V | |
| V _{CROSS(ABS)} | Absolute Crossing Voltage | 0.300 | — | 0.550 | V | 6, 7, 8 |
| ΔV _{CROSS(REL)} | Range of Crossing Points | — | — | 0.140 | V | |
| C _{IN} | Input Capacitance | 1.0 | — | 3.0 | pF | |
| SDVO_CTRLDATA, SDVO_CTRLCLK, DDPC_CTRLDATA, DDPC_CTRLCLK | | | | | | |
| V _{IL} | Input Low Voltage | — | — | 0.75 | V | |
| V _{IH} | Input High Voltage | 1.75 | — | — | V | |



Table 51. DC Characteristics

| Symbol | Parameter | Min | Nom | Max | Unit | Notes |
|----------------------------------|------------------------------------|-----------------|------------------|-----------------|---------|--------------------|
| I_{LEAK} | Input Leakage Current | — | — | ± 10 | μA | |
| C_{IN} | Input Capacitance | — | — | 10.0 | pF | |
| I_{OL} | Output Low Current (CMOS Outputs) | — | — | 7.8 | mA | @ 50% swing |
| I_{OH} | Output High Current (CMOS Outputs) | -1 | — | — | mA | @ 50% swing |
| V_{OL} | Output Low Voltage (CMOS Outputs) | — | — | 0.4 | V | |
| V_{OH} | Output High Voltage (CMOS Outputs) | 2.25 | — | — | V | |
| CRT_DDC_DATA, CRT_DDC_CLK | | | | | | |
| V_{IL} | Input Low Voltage | — | — | $0.3 * V_{CCP}$ | V | |
| V_{IH} | Input High Voltage | $0.6 * V_{CCP}$ | — | — | V | |
| I_{LEAK} | Input Leakage Current | — | — | TBD | μA | |
| C_{IN} | Input Capacitance | — | — | 10.0 | pF | |
| I_{OL} | Output Low Current (CMOS Outputs) | — | — | — | mA | @ 50% swing |
| I_{OH} | Output High Current (CMOS Outputs) | — | — | — | mA | @ 50% swing |
| V_{OL} | Output Low Voltage (CMOS Outputs) | — | — | 0.4@3mA | V | |
| V_{OH} | Output High Voltage (CMOS Outputs) | — | — | — | V | |
| HDA_BCLK, HDA_SDI | | | | | | |
| V_{IL} | Input Low Voltage | — | — | $0.4 * V_{CCP}$ | V | |
| V_{IH} | Input High Voltage | $0.6 * V_{CCP}$ | — | — | V | |
| I_{LEAK} | Input Leakage Current | — | — | ± 10 | μA | |
| C_{IN} | Input Capacitance | — | — | 7.5 | pF | |
| V_{OL} | Output Low Voltage (CMOS Outputs) | — | — | $0.10 * V_{CC}$ | V | |
| V_{OH} | Output High Voltage (CMOS Outputs) | $0.9 * V_{CC}$ | — | — | V | |
| CL_DATA, CL_CLK | | | | | | |
| V_{IL} | Input Low Voltage | — | $V_{ref} - 80mV$ | — | V | |
| V_{IH} | Input High Voltage | — | $V_{ref} + 80mV$ | — | V | |
| I_{LEAK} | Input Leakage Current | — | — | — | μA | |
| C_{IN} | Input Capacitance | — | 5 | — | pF | |
| I_{OL} | Output Low Current (CMOS Outputs) | — | ~1 | — | mA | @ V_{OL_HI} max |



Table 51. DC Characteristics

| Symbol | Parameter | Min | Nom | Max | Unit | Notes |
|--------------------------------|------------------------------------|-------------|---------|--------------|---------|--------------------|
| I_{OH} | Output High Current (CMOS Outputs) | 6.2 | 8 | 9.8 | mA | @ V_{OH_HI} min |
| V_{OL} | Output Low Voltage (CMOS Outputs) | — | 0 | — | V | |
| V_{OH} | Output High Voltage (CMOS Outputs) | 0.62 | 0.8 | 0.98 | V | |
| PWROK, CL_PWROK, RSTIN# | | | | | | |
| V_{IL} | Input Low Voltage | 1.05 | 1.081 | 1.122 | V | |
| V_{IH} | Input High Voltage | 1.93 | 2.011 | 2.093 | V | |
| I_{LEAK} | Input Leakage Current | 50 | 75 | 120 | μ A | |
| C_{IN} | Input Capacitance | 477.292 | 503.396 | 531.486 | fF | |
| CL_RST# | | | | | | |
| V_{IL} | Input Low Voltage | VSS | — | Vref – 80 mV | V | |
| V_{IH} | Input High Voltage | Vref + 80mV | — | VCC | V | |
| I_{LEAK} | Input Leakage Current | — | — | \pm 20 | μ A | |
| C_{IN} | Input Capacitance | — | — | 2.0 | pF | |
| ICH_SYNCB | | | | | | |
| I_{OL} | Output Low Current (CMOS Outputs) | — | — | 2.0 | mA | @ V_{OL_HI} max |
| I_{OH} | Output High Current (CMOS Outputs) | -2.0 | — | — | mA | @ V_{OH_HI} min |
| V_{OL} | Output Low Voltage (CMOS Outputs) | — | — | 0.33 | V | |
| V_{OH} | Output High Voltage (CMOS Outputs) | 2.97 | — | — | V | |
| CRT_HSYNC, CRT_VSYNC | | | | | | |
| I_{OL} | Output Low Current (CMOS Outputs) | — | — | — | mA | @ V_{OL_HI} max |
| I_{OH} | Output High Current (CMOS Outputs) | — | — | — | mA | @ V_{OH_HI} min |
| V_{OL} | Output Low Voltage (CMOS Outputs) | 0 | — | 0.5@ 8mA | V | |
| V_{OH} | Output High Voltage (CMOS Outputs) | 2.4 – 8mA | — | 3.6 | V | |

NOTES:

1. Determined with 2x (G)MCH Buffer Strength Settings into a 50 to 0.5xVCC_DDR test load.
2. Applies to pin to VCC or VSS leakage current for the DDR_A_DQ_63:0 and DDR_B_DQ_63:0 signals.
3. Applies to pin to pin leakage current between DDR_A_DQS_7:0, DDR_A_DQSB_7:0, DDR_B_DQS_7:0, and DDR_B_DQSB_7:0 signals.
4. Specified at the measurement point into a timing and voltage compliance test load as shown in Transmitter compliance eye diagram of PCI Express* specification and measured over any 250 consecutive TX UIs.
5. Specified at the measurement point over any 250 consecutive UIs. The test load shown in Receiver compliance eye diagram of PCI Express* spec should be used as the RX device when taking measurements.
6. Crossing voltage defined as instantaneous voltage when rising edge of BCLK0 equals falling edge of BCLK1.
7. V_{Havg} is the statistical average of the V_H measured by the oscilloscope.
8. The crossing point must meet the absolute and relative crossing point specifications simultaneously. Refer to the appropriate processor datasheet for further information.



14.3.3 R, G, B / CRT DAC Display DC Characteristics (Intel® 82Q45, 82Q43, 82B43, 82G45, 82G43, 82G41 GMCH Only)

Table 52. R, G, B / CRT DAC Display DC Characteristics: Functional Operating Range (VCCA_DAC = 3.3 V 5%)

| Parameter | Min | Typical | Max | Unit | Notes |
|--------------------------------------------------|---------|---------|------|------|-------------------------------------|
| DAC Resolution | — | 8 | — | Bits | 1 |
| Max Luminance (full-scale) | .665 | .700 | .770 | V | 1, 2, 4 (white video level voltage) |
| Min Luminance | — | 0.000 | — | V | 1, 3, 4 (black video level voltage) |
| LSB Current | | 73.2 | — | uA | 4,5 |
| Integral Linearity (INL) | -1.0 | — | +1.0 | LSB | 1,6 |
| Differential Linearity (DNL) | -1.0 | — | +1.0 | LSB | 1,6 |
| Video channel-channel voltage amplitude mismatch | — | — | 6 | % | 7 |
| Monotonicity | Ensured | | | | |

NOTES:

1. Measured at each R, G, B termination according to the VESA Test Procedure - Evaluation of Analog Display Graphics Subsystems Proposal (Version 1, Draft 4, December 1, 2000).
2. Max steady-state amplitude
3. Min steady-state amplitude
4. Defined for a double 75 ohm termination.
5. Set by external reference resistor value.
6. INL and DNL measured and calculated according to VESA Video Signal Standards.
7. Max full-scale voltage difference among R, G, B outputs (percentage of steady-state full-scale voltage).

14.3.4 Di/dt Characteristics

To decrease voltage regulator costs, design time and to improve voltage regulator efficiency, di/dt values can be used for these purposes. Also, di/dt values can be used to understand how customer's Voltage Regulator (VR) feedback mechanism has to work to limit the noise within voltage tolerance specifications.

For example, when a sudden current change (di/dt) is seen by VR, it will not follow that demand, it will have some slow response. During that time, its output voltage will tend to go low, if the response is not fast enough, they will violate voltage tolerance specifications.

Cost of VR is also a function of how fast the response time is, by having di/dt data, customers can hold dV in voltage tolerance specifications using minimum cost.

Two sets of di/dt values are provided:

"at VR level: used to optimize VR

"at package pin level: used to optimize motherboard edge capacitor

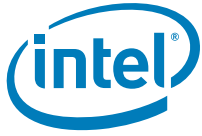

Table 53 shows the simulated di/dt data at different level for main power rails.

Table 53. Di/dt Simulation Data

| Rail | di/dt @ VR | di/dt @ package pin |
|---------|------------|------------------------------------------------|
| VTT | ~ 2mA/ns | ~ 750 mA/ns |
| VCC_DDR | ~ 4mA/ns | ~ 1.5 A/ns |
| VCC | ~ 2.8A/us | ~ 6 A/us (VR design) ~ 4 A/100ns (edge cap) |
| VCC_CL | ~ 2.8A/us | ~ 2 mA/us |
| VCC_PEG | ~ 3.5mA/ns | ~ 15 mA/ns |
| VCC_DMI | ~ 1mA/ns | ~ 3.5 mA/ns |

§ §





15 Ballout and Package Specifications

This chapter details the (G)MCH ballout and package specifications.

15.1 Ballout

Figure 18, Figure 19, and Figure 20 show the (G)MCH ballout from a top of the package view. Table 54 lists the ballout arranged alphabetically by signal name.

Note: Notes for Figure 18, Figure 19, Figure 20, and Table 54.

1. Balls that are listed as RSVD are reserved.
2. Balls that are listed as NC are No Connects.
3. Analog Display Signals (CRT_RED, CRT_REDB, CRT_GREEN, CRT_GREENB, CRT_BLUE, CRT_BLUEB, CRT_IREF, CRT_HSYNC, CRT_VSYNC, CRT_DDC_CLK, CRT_DDC_DATA) and the SDVO_CTRLCLK and SDVO_CTRLDATA signals are not used on the 82P45 and 82P42 MCH. Contact your Intel field representative for proper termination of the corresponding balls.
4. For the 82Q45, 82Q43, 82B43, 82G45, 82G43, 82G41 GMCH, the PCI Express and SDVO/HDMI signals are multiplexed. However, only the PCI Express signal name is included in the following ballout figures and table. See Section 2.8 for the signal name mapping.

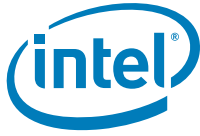

Figure 18. GMCH Ballout Diagram (Top View Left – Columns 45–31)

| | 45 | 44 | 43 | 42 | 41 | 40 | 39 | 38 | 37 | 36 | 35 | 34 | 33 | 32 | 31 | |
|----|-------------|--------------|---------------|---------------|--------------|---------------|---------------|--------------|----------------|----------------|----------------|----------------|--------------|---------------|---------------|----|
| BE | RSVD | NC | VSS | | | VSS | | DDR_B_MA_13 | | VCC_SM | | VSS | | | VCC_SM | BE |
| BD | NC | VSS | VSS | DDR_B_O_DT_3 | | DDR_B_CS_B_3 | DDR_B_CS_B_1 | VCC_SM | DDR_B_O_DT_0 | DDR_B_W_EB | DDR_B_RA_SB | VCC_SM | | DDR_A_MA_4 | DDR_A_MA_8 | BD |
| BC | VSS | DDR_SPU | DDR_SPD | | DDR_A_MA_0 | | DDR_B_O_DT_1 | | DDR_B_CA_SB | | DDR_A_MA_1 | | | DDR_A_MA_3 | | BC |
| BB | | DDR_VREF | | | | DDR3_A_M_A0 | VCC_SM | DDR_B_O_DT_2 | DDR_B_CS_B_2 | | DDR_B_CS_B_0 | | | DDR_A_MA_2 | DDR_A_MA_5 | BB |
| BA | | | DDR_RPU | | VCC_SM | | | | DDR_A_CK_B_0 | | | | | | DDR_A_MA_7 | BA |
| AY | VSS | DDR_A_BS_1 | | DDR_RPD | | VCC_SM | | DDR_A_CK_B_5 | DDR_A_CK_0 | | DDR_B_CK_B_2 | | DDR_B_CK_0 | | DDR_A_MA_6 | AY |
| AW | | NC | DDR_A_MA_10 | DDR_A_W_EB | | | DDR_B_D_Q_37 | DDR_A_CK_5 | DDR_B_CK_5 | | DDR_B_CK_2 | | DDR_B_CK_B_0 | | DDR_B_CK_B_1 | AW |
| AV | DDR_A_BS_0 | VCC_SM | | DDR_A_RA_SB | | DDR3_B_O_DT3 | DDR_B_D_Q_36 | VSS | DDR_A_CK_B_2 | | DDR_B_CK_B_5 | | VSS | | DDR_B_CK_1 | AV |
| AU | | DDR_A_CS_B_2 | DDR_A_CS_B_0 | DDR_A_CA_SB | DDR_B_D_Q_39 | DDR_B_D_Q_38 | DDR_B_D_M_4 | DDR_B_D_Q_33 | DDR_A_CK_2 | | VSS | | DDR_A_CK_B_3 | | DDR_B_CK_B_3 | AU |
| AT | VCC_SM | DDR3_A_WEB | | | | | | | | | VSS | | DDR_A_CK_B_3 | | DDR_B_CK_3 | AT |
| AR | | DDR_A_OD_T_2 | DDR3_A_C_SB1 | DDR_A_OD_T_0 | | DDR_A_CS_B_1 | VSS | DDR_B_D_QS_4 | DDR_B_D_QS_B_4 | DDR_B_D_Q_32 | VSS | | VSS | | VSS | AR |
| AP | VSS | VCC_SM | | | | | | | | | | | | | DDR_B_CK_4 | AP |
| AN | | | | | | DDR_B_D_Q_45 | DDR_B_D_Q_44 | VSS | DDR_B_D_Q_35 | VSS | DDR_B_D_Q_34 | | VSS | | | AN |
| AM | | DDR_A_OD_T_1 | DDR_A_CS_B_3 | DDR_A_MA_13 | | | | | | | | | | | VCC_SMCL_K | AM |
| AL | VSS | VSS | | DDR_A_DO_36 | DDR_A_DO_32 | DDR_A_OD_T_3 | DDR_B_D_Q_47 | VSS | DDR_B_D_M_5 | DDR_B_D_Q_41 | DDR_B_D_Q_40 | DDR_B_D_QS_B_5 | | VCC_SMCL_K | VCC_SMCL_K | AL |
| AK | | DDR_A_DO_37 | DDR_A_DO_33 | DDR_A_D_M_4 | | DDR_B_D_Q_52 | VSS | VSS | DDR_B_D_Q_46 | DDR_B_D_Q_42 | VSS | DDR_B_D_QS_5 | RSVD | VCC_SMCL_K | VCC_CL | AK |
| AJ | VSS | VSS | | | | DDR_B_D_Q_53 | VSS | DDR_B_D_Q_48 | DDR_B_D_Q_49 | VSS | DDR_B_D_M_6 | DDR_B_D_Q_43 | RSVD | VCC_CL | VCC_CL | AJ |
| AH | | DDR_A_DO_38 | DDR_A_DO_34 | DDR_A_DO_SB_4 | | | | | | | | | | | | AH |
| AG | VSS | DDR_A_DO_35 | | DDR_A_DO_34 | DDR_A_DO_39 | | | | | | | | | | VCC_CL | AG |
| AF | | DDR_A_DO_45 | DDR_A_DO_40 | DDR_A_DO_41 | | DDR_A_DO_44 | VSS | DDR_B_D_Q_50 | DDR_B_D_QS_6 | DDR_B_D_QS_B_6 | VSS | DDR_B_D_Q_54 | VSS | VCC_CL | VCC_CL | AF |
| AE | DDR_A_D_M_5 | VSS | | DDR_A_DO_SB_5 | | VSS | DDR_B_D_Q_61 | VSS | DDR_B_D_Q_51 | DDR_B_D_Q_60 | DDR_B_D_Q_55 | VSS | VCC_CL | VCC_CL | VCC_CL | AE |
| AD | | DDR_A_DO_46 | DDR_A_DO_35 | NC | | DDR_B_D_Q_56 | VSS | DDR_B_D_Q_57 | DDR_B_D_M_7 | VSS | DDR_B_D_QS_B_7 | VSS | VCC_CL | VCC_CL | VCC_CL | AD |
| AC | VSS | DDR_A_DO_42 | | DDR_A_DO_43 | DDR_A_DO_47 | | | | | | | | | | VCC_CL | AC |
| AB | | DDR_A_DO_53 | DDR_A_DO_48 | DDR_A_DO_52 | | DDR_B_D_Q_58 | VSS | DDR_B_D_Q_63 | DDR_B_D_Q_62 | VSS | DDR_B_D_QS_7 | VSS | VCC_CL | VCC_CL | VCC_CL | AB |
| AA | DDR_A_D_M_6 | VSS | | DDR_A_DO_49 | | VSS | DDR_B_D_Q_59 | VSS | FSB_AB_3_4 | FSB_AB_3_5 | FSB_AB_2_9 | VSS | VCC_CL | VCC_CL | VCC_CL | AA |
| Y | | DDR_A_DO_54 | DDR_A_DO_36 | DDR_A_DO_SB_6 | | DDR_A_DO_55 | VSS | FSB_AB_3_3 | FSB_AB_3_1 | FSB_AB_2_7 | VSS | FSB_AB_3_2 | VCC_CL | VCC_CL | VCC_CL | Y |
| W | VSS | VSS | | DDR_A_DO_50 | DDR_A_DO_51 | | | | | | | | | | VCC_CL | W |
| V | | DDR_A_DO_60 | DDR_A_DO_61 | DDR_A_DO_56 | | | | | | | | | | | | V |
| U | DDR_A_DO_57 | VSS | | | | FSB_AB_2_5 | VSS | FSB_AB_2_2 | FSB_AB_3_0 | VSS | FSB_AB_2_8 | FSB_AB_2_4 | VCCD_HPL_L | NC | RSVD | U |
| T | | DDR_A_DO_57 | DDR_A_DO_SB_7 | DDR_A_D_M_7 | | VSS | FSB_ADST_BB_1 | VSS | FSB_AB_2_3 | FSB_AB_1_7 | VSS | FSB_AB_2_6 | VSS | VSS | VSS | T |
| R | VSS | DDR_A_DO_63 | | NC | DDR_A_DO_62 | DDR_A_DO_58 | FSB_AB_2_1 | VSS | FSB_AB_2_0 | FSB_AB_1_8 | FSB_AB_1_6 | FSB_AB_1_9 | | RSVD | RSVD | R |
| P | | DDR_A_DO_59 | DPRSTPB | SLPB | | | | | | | | | | | VSS | P |
| N | | | | | | FSB_AB_1_4 | FSB_AB_1_0 | VSS | FSB_AB_2_1 | VSS | FSB_AB_1_1 | | VSS | | | N |
| M | FSB_AB_1_5 | VSS | | | | | | | | | | | | | FSB_DB_2_5 | M |
| L | | FSB_RS_B_1 | FSB_AB_9 | FSB_BREQ_0B | | FSB_TRDY_B | VSS | FSB_AB_8 | FSB_AB_4 | FSB_AB_3 | VSS | | FSB_DB_2_2 | | FSB_DB_2_4 | L |
| K | VSS | FSB_HITM_B | | | | | | | | | FSB_REOB_1 | | VSS | | FSB_DSTB_PB_1 | K |
| J | | FSB_BNRB | FSB_DRDY_B | FSB_ADSB | FSB_AB_3_1 | FSB_ADST_BB_0 | FSB_REOB_2 | FSB_AB_5 | VSS | | FSB_DB_1_7 | | FSB_DB_2_1 | | FSB_DSTB_NB_1 | J |
| H | FSB_HITB | VSS | | FSB_DBSY_B | | FSB_LOCK_B | FSB_AB_7 | VSS | FSB_BPRIB | | FSB_DB_1_8 | | VSS | | VSS | H |
| G | | FSB_DEFE_RB | FSB_RS_B_0 | FSB_RS_B_2 | | | FSB_REOB_4 | FSB_REOB_0 | FSB_DB_2_0 | | VSS | | FSB_DB_2_3 | | FSB_DB_2_8 | G |
| F | VSS | FSB_DB_0 | | VSS | | FSB_AB_6 | | FSB_DB_9 | FSB_DB_1_9 | | FSB_DB_5_0 | FSB_DINV_B_1 | | | FSB_DB_5_7 | F |
| E | | | FSB_DB_4 | | VSS | | | | FSB_DB_1_6 | | | | | | VSS | E |
| D | | FSB_DB_2 | | | | FSB_DB_6 | VSS | FSB_DB_1_2 | FSB_DB_1_4 | | FSB_DB_5_3 | | | FSB_DSTB_NB_3 | FSB_DB_5_4 | D |
| C | VSS | FSB_DB_1 | FSB_REOB_3 | | FSB_DB_3 | | FSB_DSTB_PB_0 | | FSB_DB_1_3 | | FSB_DB_5_1 | | | FSB_DSTB_PB_3 | | C |
| B | NC | VSS | FSB_DB_5 | FSB_DB_7 | | FSB_DINV_B_0 | FSB_DSTB_NB_0 | FSB_DB_8 | FSB_DB_1_1 | FSB_DB_1_5 | FSB_DB_5_2 | VSS | | FSB_DB_5_6 | FSB_DB_4_9 | B |
| A | RSVD | NC | VSS | | | VSS | | FSB_DB_1_0 | | VSS | | FSB_DB_5_5 | | | VSS | A |



Figure 19. GMCH Ballout Diagram (Top View Left – Columns 30–16)

| | 30 | 29 | 28 | 27 | 26 | 25 | 24 | 23 | 22 | 21 | 20 | 19 | 18 | 17 | 16 | |
|----|--------------|--------------|-------------|--------------|---------------|---------------|----------------|--------------|---------------|--------------|----------------|-------------|--------------|---------------|--------------|----|
| BE | | VSS | | VCC_SM | | VSS | | VCC_SM | | VSS | | VSS | | DDR_B_CK_E_2 | | BE |
| BD | DDR_A_MA_9 | VCC_SM | DDR_A_MA_14 | DDR_A_CK_E_1 | DDR_B_BS_0 | VCC_SM | DDR_B_MA_0 | DDR_B_MA_3 | DDR_B_MA_5 | VCC_SM | DDR_B_MA_9 | DDR_B_MA_11 | DDR_B_BS_2 | VSS | DDR_A_DO_23 | BD |
| BC | DDR_A_MA_11 | | DDR_A_BS_2 | | DDR_B_MA_10 | | DDR3_DRA_MRSTB | | DDR_B_MA_6 | | DDR_B_MA_7 | | DDR_B_CK_E_0 | | DDR_A_DO_18 | BC |
| BB | DDR_A_MA_12 | | VSS | DDR_A_CK_E_0 | DDR_B_BS_1 | VSS | DDR_B_MA_2 | DDR_B_MA_1 | DDR_B_MA_4 | VSS | DDR_B_MA_8 | DDR_B_MA_12 | DDR_B_CK_E_3 | | DDR_A_DO_19 | BB |
| BA | | | | DDR_A_CK_E_2 | | | | VSS | | | | DDR_B_MA_14 | | | | BA |
| AY | VSS | DDR_A_CK_B_1 | | | DDR_A_CK_E_3 | VSS | DDR_A_DO_27 | | DDR_A_DO_25 | VSS | DDR_B_CK_E_7 | | | DDR_B_D_Q_16 | VSS | AY |
| AW | VSS | DDR_A_CK_1 | | | VSS | DDR_B_D_Q_28 | VSS | | VSS | DDR_A_DO_24 | VSS | | | VSS | DDR_B_D_Q_21 | AW |
| AV | VSS | DDR_B_D_Q_27 | | | DDR_B_D_Q_25 | DDR_B_D_M_3 | DDR_A_DO_26 | | DDR_A_D_M_3 | VSS | DDR_B_D_Q_19 | | | DDR_B_D_Q_17 | VSS | AV |
| AU | VSS | DDR_B_D_Q_26 | | | DDR_B_D_QS_3 | VSS | DDR_A_DO_31 | | VSS | DDR_A_DO_28 | VSS | | | DDR_B_D_M_2 | DDR_B_D_Q_15 | AU |
| AT | DDR_A_CK_4 | VSS | | | DDR_B_D_QSB_3 | DDR_B_D_Q_24 | VSS | | DDR_A_DO_SB_3 | DDR_A_DO_29 | DDR_B_D_Q_22 | | | VSS | DDR_B_D_Q_11 | AT |
| AR | DDR_A_CK_B_4 | DDR_B_D_Q_31 | | | VSS | DDR_B_D_Q_29 | DDR_A_DO_30 | | DDR_A_DO_S_3 | DDR_B_D_Q_18 | DDR_B_D_QS_2 | | | DDR_B_D_QSB_2 | VSS | AR |
| AP | DDR_B_CK_B_4 | VSS | | | DDR_B_D_Q_30 | VSS | VSS | | VSS | VSS | VSS | | | DDR_B_D_Q_20 | DDR_B_D_Q_14 | AP |
| AN | RSVD | RSVD | | | VSS | VSS | VSS | | VSS | VSS | DDR_B_D_Q_23 | | | NC | NC | AN |
| AM | VCCML_DR | VCC_CL | | | VCC_CL | VCC_CL | VCC_CL | | VCC_CL | VCC_CL | VCC_CL | | | VCC_CL | VCC_CL | AM |
| AL | VCC_CL | VCC_CL | | | VCC_CL | VCC_CL | VCC_CL | VCC_CL | VCC_CL | VCC_CL | VCC_CL | VCC_CL | | VCC_CL | VCC_CL | AL |
| AK | VCC_CL | VCC_CL | | | VCC_CL | VCC_CL | VCC_CL | VCC_CL | VCC_CL | VCC_CL | VCC_CL | VCC_CL | | VCC_CL | VCC_CL | AK |
| AJ | VCC_CL | VCC_CL | | | VCC_CL | VSS | VCC | VSS | VCC | VSS | VCC | VSS | VCC | VCC | VCC | AJ |
| AH | | | | | | | | | | | | | | | | AH |
| AG | VCC_CL | VCC | | | VSS | VCC | VSS | VCC | VSS | VCC | VSS | VCC | VSS | VCC | VCC | AG |
| AF | NC | VCC | | | VCC | VCC | VCC | VCC | VCC | VCC | VCC | VCC | VCC | VCC | VCC | AF |
| AE | NC | VCC | | | VCC | VSS | VCC | VSS | VCC | VSS | VCC | VSS | VCC | VCC | VCC | AE |
| AD | NC | VCC | | | VSS | VCC | VSS | VCC | VSS | VCC | VSS | VCC | VSS | VCC | VCC | AD |
| AC | NC | VCC | | | VCC | VSS | VCC | VSS | VCC | VSS | VCC | VSS | VCC | VCC | VCC | AC |
| AB | VCC | VCC | | | VSS | VCC | VSS | VCC | VSS | VCC | VSS | VCC | VSS | VSS | VSS | AB |
| AA | VCC | VCC | | | VCC | VSS | VCC | VSS | VCC | VSS | VCC | VSS | VCC | VSS | VSS | AA |
| Y | VCC_CL | VCC_CL | | | VSS | VCC | VSS | VCC | VSS | VCC | VSS | VCC | VSS | VSS | VSS | Y |
| W | NC | VCC | | | VCC | VSS | VCC | VSS | VCC | VSS | VCC | VSS | VCC | VSS | VSS | W |
| V | | | | | | | | | | | | | | | | V |
| U | RSVD | VCC | | | VCC | VCC | VCC | VCC | VCC | VCC | VSS | VSS | | VSS | VSS | U |
| T | VSS | VCC | | | VCC | VCC | VCC | VCC | VCC | VCC | VSS | VSS | | VSS | VSS | T |
| R | VSS | VCC | | | VCC | VCC | VCC | VTT_FSB | VTT_FSB | VTT_FSB | VTT_FSB | VSS | | VSS | VSS | R |
| P | HPL_CLKIN_N | HPL_CLKIN_P | | | VSS | VSS | VTT_FSB | | VTT_FSB | VTT_FSB | VTT_FSB | | | VSS | VSS | P |
| N | VSS | VSS | | | VSS | RSVD | FSB_DB_4_7 | | VTT_FSB | VTT_FSB | VTT_FSB | | | XORTEST | VSS | N |
| M | FSB_DB_2_6 | FSB_DB_3_0 | | | FSB_DB_3_9 | VSS | VSS | | VTT_FSB | VTT_FSB | ALLZTEST | | | RSVD | RSVD | M |
| L | VSS | FSB_DB_3_7 | | | VSS | FSB_DB_3_5 | FSB_DB_4_5 | | VTT_FSB | VTT_FSB | VSS | | | ITPM_ENB | VSS | L |
| K | FSB_DB_2_9 | VSS | | | FSB_DB_3_6 | FSB_DSTB_NB_2 | VSS | | VTT_FSB | VTT_FSB | VSS | | | VSS | RSVD | K |
| J | FSB_DB_2_7 | FSB_DB_3_2 | | | FSB_DB_3_8 | FSB_DSTB_PB_2 | FSB_DB_4_6 | | VTT_FSB | VTT_FSB | RSVD | | | CEN | RSVD | J |
| H | VSS | FSB_DB_3_4 | | | FSB_DB_4_0 | VSS | FSB_DB_4_4 | | VTT_FSB | VTT_FSB | VSS | | | EXP_SM | VSS | H |
| G | FSB_DB_3_1 | VSS | | | VSS | FSB_DB_4_3 | VSS | | VTT_FSB | VTT_FSB | BSCANTES_T | | | VSS | BSEL1 | G |
| F | VSS | FSB_DB_3_3 | | | FSB_DINV_B_2 | FSB_DB_4_1 | FSB_DB_4_2 | | VTT_FSB | VTT_FSB | DualX8_En_able | | | BSEL0 | VSS | F |
| E | | | | | FSB_DB_6_2 | | | | VTT_FSB | | | | VCC3_3 | | | E |
| D | FSB_DINV_B_3 | | FSB_DB_5_8 | FSB_CPURSTB | VSS | VSS | VTT_FSB | VTT_FSB | VTT_FSB | VSS | VCCA_DPLA | VCCA_DAC | CRT_GREEN | | VSS | D |
| C | FSB_DB_6_0 | | FSB_DB_4_8 | | VTT_FSB | | VTT_FSB | | FSB_DVREF | | VCCA_DPLB | | CRT_BLUE | | VSS | C |
| B | FSB_DB_6_1 | VSS | FSB_DB_6_3 | VSS | VTT_FSB | VTT_FSB | FSB_SWING | FSB_ACCV_REF | VCCA_HPL_L | VSS | VCCDO_CRT | VCCA_DAC | CRT_RED | VSS | VCCAPLL_EXP | B |
| A | | FSB_DB_5_9 | | | VSS | | VTT_FSB | | FSB_RCOMP | | VCCA_MPL_L | | VSS | | VCCA_EXP | A |

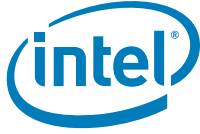

Figure 20. GMCH Ballout Diagram (Top View Left – Columns 15–1)

| | 15 | 14 | 13 | 12 | 11 | 10 | 9 | 8 | 7 | 6 | 5 | 4 | 3 | 2 | 1 | |
|----|----------------|--------------|----------------|--------------|----------------|--------------|------------------|------------------|--------------|-----------------|--------------|---------------|-------------|-------------|------------|----|
| BE | VSS | | | DDR_A_D Q_21 | | VSS | | DDR_A_D Q_13 | | DDR_A_D Q_6 | | | VSS | NC | RSVD | BE |
| BD | DDR_A_D OS_2 | DDR_A_D M_2 | | VSS | DDR_A_D Q_10 | DDR_A_D Q_14 | DDR_A_D M_1 | VSS | DDR_A_D Q_2 | DDR_A_D Q_7 | | DDR_A_D OSB_0 | DDR_A_D Q_1 | VSS | NC | BD |
| BC | | DDR_A_D Q_17 | | | DDR_A_D Q_20 | | DDR_A_D OSB_1 | | DDR_A_D Q_12 | | DDR_A_D OS_0 | | DDR_A_D M_0 | DDR_A_D Q_0 | VSS | BC |
| BB | DDR_A_D OSB_2 | DDR_A_D Q_16 | | | DDR_A_D Q_11 | | DDR_A_D OS_1 | DDR_A_D Q_8 | DDR_A_D Q_3 | VSS | | | | DDR_A_D Q_4 | | BB |
| BA | DDR_A_D Q_22 | | | | | | DDR_B_D Q_2 | | | | VSS | | DDR_A_D Q_5 | | | BA |
| AY | VSS | | DDR_B_D Q_8 | | DDR_A_D Q_15 | | DDR_B_D Q_7 | DDR_A_D Q_9 | | DDR_B_D M_0 | | CL_DATA | | CL_CLK | VSS | AY |
| AW | DDR_B_D Q_10 | | DDR_B_D Q_13 | | VSS | | DDR_B_D OSB_0 | DDR_B_D OS_0 | DDR_B_D Q_6 | | | DDR_B_D Q_1 | VSS | CL_RSTB | | AW |
| AV | VSS | | VSS | | VSS | | VSS | VSS | DDR_B_D Q_0 | VSS | | HDA_RSTB | | VSS | HDA_SDO | AV |
| AU | DDR_B_D OSB_1 | | DDR_B_D Q_12 | | DDR_B_D Q_3 | | VSS | DDR_B_D Q_5 | DDR_B_D Q_4 | VSS | VSS | HDA_BCLK | HDA_SYNC | HDA_SDI | | AU |
| AT | DDR_B_D OS_1 | | VSS | | VSS | | | | | | | | | VSS | VSS | AT |
| AR | DDR_B_D M_1 | | VSS | | VSS | VSS | VSS | VSS | JTAG_TDI | DDR3_DRAM_PWROK | | PWROK | VSS | VCC_HDA | | AR |
| AP | DDR_B_D Q_9 | | | | | | | | | | | | | VCC_CL | VCC_CL | AP |
| AN | | | CL_VREF | | JTAG_TCK | JTAG_TDO | JTAG_TMS | CL_PWROK | VSS | RSTINB | | | | | | AN |
| AM | VCC_CL | | | | | | | | | | | VCC_CL | VCC_CL | VCC_CL | | AM |
| AL | VCC_CL | VCC_CL | | VCC_CL | VCC_CL | VCC_CL | VCC_CL | VCC_CL | VCC_CL | VCC_CL | VCC_CL | VCC_CL | VCC_CL | VCC_CL | VCC_CL | AL |
| AK | NC | VCC_CL | VCC_EXP | VCC_EXP | VCC_EXP | VCC_EXP | VCC_EXP | VCC_EXP | VCC_EXP | VCC_EXP | | VCC_EXP | VCC_EXP | VCC_EXP | | AK |
| AJ | VCC_CL | VCC_EXP | VCC_EXP | VCC_EXP | VCC_EXP | VCC_EXP | VCC_EXP | VCC_EXP | VCC_EXP | VCC_EXP | | | | VCC_EXP | VCC_EXP | AJ |
| AH | | | | | | | | | | | | VSS | VSS | VSS | | AH |
| AG | VCC_EXP | | | | | | | | | | VSS | DMI_TXN_3 | VCCAVRM_EXP | EXP_RBIA_S | | AG |
| AF | VCC_EXP | VCC_EXP | VSS | VSS | VSS | VSS | DMI_RXP_3 | DMI_RXN_3 | VSS | VSS | | DMI_TXP_3 | VCC | DMI_TXN_2 | | AF |
| AE | VCC_EXP | VCC_EXP | VSS | VSS | VSS | DMI_RXN_1 | DMI_RXP_1 | VSS | DMI_RXN_2 | DMI_RXP_2 | | DMI_TXN_1 | | DMI_TXP_2 | VSS | AE |
| AD | VCC_EXP | VCC_EXP | RSVD | VSS | PEG_RXN_15 | PEG_RXP_15 | VSS | DMI_RXN_0 | DMI_RXP_0 | VSS | | DMI_TXP_1 | VSS | DMI_TXN_0 | | AD |
| AC | VCC_EXP | | | | | | | | | | VSS | VCC | | DMI_TXP_0 | PEG_TXP_15 | AC |
| AB | RSVD | VCC_EXP | RSVD | VSS | VSS | PEG_RXP_13 | PEG_RXN_13 | VSS | VSS | VSS | | VSS | PEG_RXP_14 | PEG_TXN_15 | | AB |
| AA | VCC_EXP | VCC_EXP | VSS | VSS | VSS | PEG_RXN_10 | PEG_RXP_10 | VSS | PEG_RXP_12 | PEG_RXN_12 | | PEG_TXP_14 | | PEG_RXN_14 | VSS | AA |
| Y | VCC_EXP | VCC_EXP | VSS | VSS | VSS | VSS | VSS | EXP_COMP_1 | EXP_RCOMP_PO | EXP_ICOMP_PO | | PEG_TXN_14 | VSS | VSS | | Y |
| W | VCC_EXP | | | | | | | | | | VSS | PEG_TXP_13 | | VSS | VSS | W |
| V | | | | | | | | | | | | VCC | PEG_TXN_13 | PEG_TXN_12 | | V |
| U | VCC_EXP | VCC_EXP | VSS | VSS | VSS | PEG_RXP_8 | PEG_RXN_8 | VSS | PEG_RXN_9 | PEG_RXP_9 | | | | PEG_TXP_12 | VSS | U |
| T | RSVD | RSVD | VSS | VSS | VSS | VSS | VSS | VSS | VSS | VSS | | VSS | VSS | PEG_TXP_11 | | T |
| R | RSVD | RSVD | | VSS | VSS | PEG_RXN_7 | PEG_RXP_7 | VSS | PEG_RXP_6 | PEG_RXN_6 | VSS | PEG_RXP_11 | | VSS | PEG_TXN_11 | R |
| P | BSEL2 | | | | | | | | | | | PEG_RXN_11 | VCC | PEG_TXP_10 | | P |
| N | | | VSS | | VSS | PEG_RXN_4 | PEG_RXP_4 | VSS | PEG_RXP_5 | PEG_RXN_5 | | | | | | N |
| M | CRT_DDC_CLK | | | | | | | | | | | | | PEG_TXN_10 | VSS | M |
| L | CRT_DDC_DATA | | RSVD | | RSVD | VSS | VSS | VSS | PEG_RXN_3 | PEG_RXP_3 | | VSS | VCC | PEG_TXN_9 | | L |
| K | TCH_SYNC_B | | VSS | | VSS | | | | | | | | | PEG_TXN_8 | PEG_TXP_9 | K |
| J | RSVD | | SDVO_CTR_LDATA | | DDPC_CTR_LCLK | | VSS | VSS | PEG_RXN_2 | PEG_RXP_2 | VSS | VSS | VSS | PEG_TXP_8 | | J |
| H | VSS | | VSS | | VSS | | VSS | VSS | VSS | PEG_RXP_1 | | VCC | | PEG_TXP_7 | VSS | H |
| G | RSVD | | SDVO_CTR_LCLK | | VSS | | DPL_REFS_SCLKINN | DPL_REFS_SCLKINP | PEG_RXN_0 | | | PEG_RXN_1 | VSS | PEG_TXN_7 | | G |
| F | EXP_SLR | | CRT_IRTN | | DDPC_CTR_LDATA | | VCC | VSS | | PEG_RXP_0 | | VSS | | VSS | VSS | F |
| E | DPL_REFC_LKINP | | | | | | EXP_CLKN | | | | VSS | | VSS | | | E |
| D | DPL_REFC_LKINN | CRT_HSYN_C | | | VSS | | EXP_CLKP | PEG_TXN_2 | VSS | VSS | | | | PEG_TXP_6 | | D |
| C | | CRT_VSYN_C | | | PEG_TXP_0 | | PEG_TXP_2 | | PEG_TXN_3 | | VSS | | VSS | PEG_TXN_6 | VSS | C |
| B | DAC_IREF | NC | | VCCDPLL_EXP | PEG_TXN_0 | VSS | PEG_TXN_1 | PEG_TXP_3 | PEG_TXP_4 | PEG_TXN_4 | | PEG_TXN_5 | PEG_TXP_5 | RSVD | | B |
| A | VSS | | | VSS | | PEG_TXP_1 | | VSS | | VSS | | | VSS | | | A |



Table 54. GMCH Ballout Arranged by Signal Name

| Signal Names | Ball # | X[mils] | Y[mils] |
|--------------|--------|---------|---------|
| VTT_FSB | A25 | -66 | -642.3 |
| VTT_FSB | B25 | -66 | -609.3 |
| VTT_FSB | B26 | -99 | -625.6 |
| VTT_FSB | C24 | -33 | -592.1 |
| VTT_FSB | C26 | -99 | -592.1 |
| VTT_FSB | D22 | 31 | -560.6 |
| VTT_FSB | D23 | 0 | -575.3 |
| VTT_FSB | D24 | -31 | -560.6 |
| VTT_FSB | E23 | 0 | -547.7 |
| VTT_FSB | F21 | 70.5 | -514.5 |
| VTT_FSB | F22 | 19.5 | -514.5 |
| VTT_FSB | G21 | 70.5 | -486.5 |
| VTT_FSB | G22 | 19.5 | -486.5 |
| VTT_FSB | H21 | 70.5 | -458.5 |
| VTT_FSB | H22 | 19.5 | -458.5 |
| VTT_FSB | J21 | 70.5 | -430.5 |
| VTT_FSB | J22 | 19.5 | -430.5 |
| VTT_FSB | K21 | 70.5 | -402.5 |
| VTT_FSB | K22 | 19.5 | -402.5 |
| VTT_FSB | L21 | 70.5 | -374.5 |
| VTT_FSB | L22 | 19.5 | -374.5 |
| VTT_FSB | M21 | 70.5 | -346.5 |
| VTT_FSB | M22 | 19.5 | -346.5 |
| VTT_FSB | N20 | 121.5 | -318.9 |
| VTT_FSB | N21 | 70.5 | -318.9 |
| VTT_FSB | N22 | 19.5 | -318.9 |
| VTT_FSB | P20 | 121.5 | -290.9 |
| VTT_FSB | P21 | 70.5 | -290.9 |
| VTT_FSB | P22 | 19.5 | -290.9 |
| VTT_FSB | P24 | -19.5 | -290.9 |
| VTT_FSB | R20 | 109.2 | -254.8 |
| VTT_FSB | R23 | 0 | -254.8 |
| VTT_FSB | R24 | -36.4 | -254.8 |
| VSS | B17 | 198 | -609.3 |
| VSS | A3 | 579.3 | -642.3 |
| VSS | A43 | -579.3 | -642.3 |
| VSS | A6 | 527.9 | -642.3 |
| VSS | B44 | -610.8 | -610.8 |
| VSS | BC1 | 642.3 | 579.3 |
| VSS | BC45 | -642.3 | 579.3 |
| VSS | BD2 | 610.8 | 610.8 |
| VSS | BD44 | -610.8 | 610.8 |
| VSS | BE3 | 579.3 | 642.3 |

Table 54. GMCH Ballout Arranged by Signal Name

| Signal Names | Ball # | X[mils] | Y[mils] |
|--------------|--------|---------|---------|
| VSS | BE43 | -579.3 | 642.3 |
| VSS | C1 | 642.3 | -579.3 |
| VSS | C45 | -642.3 | -579.3 |
| VSS | F1 | 642.3 | -527.9 |
| VSS | A12 | 330 | -642.3 |
| VSS | A15 | 264 | -642.3 |
| VSS | A19 | 132 | -642.3 |
| VSS | A27 | -132 | -642.3 |
| VSS | A31 | -264 | -642.3 |
| VSS | A36 | -396 | -642.3 |
| VSS | A40 | -527.9 | -642.3 |
| VSS | AA1 | 642.3 | -66 |
| VSS | AA11 | 374.5 | -70.5 |
| VSS | AA12 | 346.5 | -70.5 |
| VSS | AA13 | 318.9 | -70.5 |
| VSS | AA20 | 109.2 | -72.8 |
| VSS | AA22 | 36.4 | -72.8 |
| VSS | AA24 | -36.4 | -72.8 |
| VSS | AA26 | -109.2 | -72.8 |
| VSS | AA34 | -346.5 | -70.5 |
| VSS | AA38 | -458.5 | -70.5 |
| VSS | AA40 | -514.5 | -70.5 |
| VSS | AA44 | -609.3 | -66 |
| VSS | AA8 | 458.5 | -70.5 |
| VSS | AB11 | 374.5 | -19.5 |
| VSS | AB12 | 346.5 | -19.5 |
| VSS | AB19 | 145.6 | -36.4 |
| VSS | AB21 | 72.8 | -36.4 |
| VSS | AB23 | 0 | -36.4 |
| VSS | AB25 | -72.8 | -36.4 |
| VSS | AB27 | -145.6 | -36.4 |
| VSS | AB34 | -346.5 | -19.5 |
| VSS | AB36 | -402.5 | -19.5 |
| VSS | AB39 | -486.5 | -19.5 |
| VSS | AB4 | 560.6 | -31 |
| VSS | AB6 | 514.5 | -19.5 |
| VSS | AB7 | 486.5 | -19.5 |
| VSS | AB8 | 458.5 | -19.5 |
| VSS | AC20 | 109.2 | 0 |
| VSS | AC22 | 36.4 | 0 |
| VSS | AC24 | -36.4 | 0 |
| VSS | AC26 | -109.2 | 0 |
| VSS | AC45 | -642.3 | 0 |

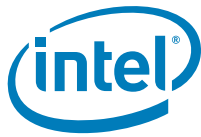

Table 54. GMCH Ballout Arranged by Signal Name

| Signal Names | Ball # | X[mils] | Y[mils] |
|--------------|--------|---------|---------|
| VSS | AC5 | 547.7 | 0 |
| VSS | AD12 | 346.5 | 19.5 |
| VSS | AD19 | 145.6 | 36.4 |
| VSS | AD21 | 72.8 | 36.4 |
| VSS | AD23 | 0 | 36.4 |
| VSS | AD25 | -72.8 | 36.4 |
| VSS | AD27 | -145.6 | 36.4 |
| VSS | AD3 | 592.1 | 33 |
| VSS | AD34 | -346.5 | 19.5 |
| VSS | AD36 | -402.5 | 19.5 |
| VSS | AD39 | -486.5 | 19.5 |
| VSS | AD6 | 514.5 | 19.5 |
| VSS | AD9 | 430.5 | 19.5 |
| VSS | AE1 | 642.3 | 66 |
| VSS | AE11 | 374.5 | 70.5 |
| VSS | AE20 | 109.2 | 72.8 |
| VSS | AE22 | 36.4 | 72.8 |
| VSS | AE24 | -36.4 | 72.8 |
| VSS | AE26 | -109.2 | 72.8 |
| VSS | AE34 | -346.5 | 70.5 |
| VSS | AE38 | -458.5 | 70.5 |
| VSS | AE40 | -514.5 | 70.5 |
| VSS | AE44 | -609.3 | 66 |
| VSS | AE8 | 458.5 | 70.5 |
| VSS | AF10 | 402.5 | 121.5 |
| VSS | AF11 | 374.5 | 121.5 |
| VSS | AF12 | 346.5 | 121.5 |
| VSS | AF13 | 318.9 | 121.5 |
| VSS | AF33 | -318.9 | 121.5 |
| VSS | AF35 | -374.5 | 121.5 |
| VSS | AF39 | -486.5 | 121.5 |
| VSS | AF6 | 514.5 | 121.5 |
| VSS | AF7 | 486.5 | 121.5 |
| VSS | AG19 | 145.6 | 145.6 |
| VSS | AG21 | 72.8 | 145.6 |
| VSS | AG23 | 0 | 145.6 |
| VSS | AG25 | -72.8 | 145.6 |
| VSS | AG27 | -145.6 | 145.6 |
| VSS | AG45 | -642.3 | 132 |
| VSS | AG5 | 547.7 | 132 |
| VSS | AH2 | 625.6 | 165 |
| VSS | AH3 | 592.1 | 165 |
| VSS | AH4 | 560.6 | 165 |

Table 54. GMCH Ballout Arranged by Signal Name

| Signal Names | Ball # | X[mils] | Y[mils] |
|--------------|--------|---------|---------|
| VSS | AJ20 | 109.2 | 182 |
| VSS | AJ22 | 36.4 | 182 |
| VSS | AJ24 | -36.4 | 182 |
| VSS | AJ26 | -109.2 | 182 |
| VSS | AJ36 | -402.5 | 172.5 |
| VSS | AJ39 | -486.5 | 172.5 |
| VSS | AJ44 | -609.3 | 198 |
| VSS | AJ45 | -642.3 | 198 |
| VSS | AK35 | -374.5 | 223.5 |
| VSS | AK38 | -458.5 | 223.5 |
| VSS | AK39 | -486.5 | 223.5 |
| VSS | AL38 | -458.5 | 274.5 |
| VSS | AL44 | -608.8 | 264 |
| VSS | AL45 | -642.3 | 264 |
| VSS | AN33 | -321.4 | 321.4 |
| VSS | AN36 | -402.5 | 321.5 |
| VSS | AN38 | -458.5 | 321.5 |
| VSS | AN7 | 486.5 | 321.5 |
| VSS | AP20 | 121.5 | 346.5 |
| VSS | AP22 | 19.5 | 346.5 |
| VSS | AP24 | -19.5 | 346.5 |
| VSS | AP29 | -172.5 | 346.5 |
| VSS | AP45 | -642.3 | 330 |
| VSS | AR10 | 401.3 | 369.5 |
| VSS | AR11 | 357.9 | 357.9 |
| VSS | AR16 | 223.5 | 374.5 |
| VSS | AR26 | -121.5 | 374.5 |
| VSS | AR31 | -274.5 | 374.5 |
| VSS | AR33 | -321.5 | 371.4 |
| VSS | AR35 | -357.9 | 357.9 |
| VSS | AR39 | -486.5 | 369.5 |
| VSS | AR8 | 458.5 | 369.5 |
| VSS | AR9 | 430.5 | 369.5 |
| VSS | AT1 | 642.3 | 396 |
| VSS | AT11 | 369.5 | 401.3 |
| VSS | AT13 | 321.5 | 402.5 |
| VSS | AT17 | 172.5 | 402.5 |
| VSS | AT2 | 608.8 | 396 |
| VSS | AT24 | -19.5 | 402.5 |
| VSS | AT29 | -172.5 | 402.5 |
| DDR_A_CKB_3 | AT33 | -321.5 | 402.5 |
| VSS | AT35 | -369.5 | 401.3 |
| VSS | AU20 | 121.5 | 430.5 |

Table 54. GMCH Ballout Arranged by Signal Name

| Signal Names | Ball # | X[mils] | Y[mils] |
|--------------|--------|---------|---------|
| VSS | AU22 | 19.5 | 430.5 |
| VSS | AU25 | -70.5 | 430.5 |
| VSS | AU30 | -223.5 | 430.5 |
| VSS | AU9 | 418 | 418 |
| VSS | AV13 | 321.5 | 458.5 |
| VSS | AV15 | 274.5 | 458.5 |
| VSS | AV16 | 223.5 | 458.5 |
| VSS | AV2 | 609.3 | 462 |
| VSS | AV21 | 70.5 | 458.5 |
| VSS | AV30 | -223.5 | 458.5 |
| VSS | AV38 | -462.5 | 462.5 |
| VSS | AV8 | 462.5 | 462.5 |
| VSS | AW11 | 369.5 | 486.5 |
| VSS | AW17 | 172.5 | 486.5 |
| VSS | AW20 | 121.5 | 486.5 |
| VSS | AW22 | 19.5 | 486.5 |
| VSS | AW24 | -19.5 | 486.5 |
| VSS | AW26 | -121.5 | 486.5 |
| VSS | AW3 | 592 | 495 |
| VSS | AW30 | -223.5 | 486.5 |
| VSS | AY1 | 642.3 | 527.9 |
| VSS | AY16 | 223.5 | 514.5 |
| VSS | AY21 | 70.5 | 514.5 |
| VSS | AY25 | -70.5 | 514.5 |
| VSS | AY30 | -223.5 | 514.5 |
| VSS | AY45 | -642.3 | 527.9 |
| VSS | B21 | 66 | -609.3 |
| VSS | B27 | -132 | -608.8 |
| VSS | B29 | -198 | -609.3 |
| VSS | B34 | -330 | -609.3 |
| VSS | BA23 | 0 | 547.7 |
| VSS | BA5 | 544.9 | 544.9 |
| VSS | BB21 | 64 | 559.1 |
| VSS | BB25 | -64 | 559.1 |
| VSS | BB28 | -165 | 560.6 |
| VSS | BB6 | 523 | 576.3 |
| VSS | BD12 | 330 | 609.3 |
| VSS | BD17 | 198 | 609.3 |
| VSS | BD8 | 462 | 609.3 |
| VSS | BE10 | 396 | 642.3 |
| VSS | BE15 | 264 | 642.3 |
| VSS | BE19 | 132 | 642.3 |
| VSS | BE21 | 66 | 642.3 |

Table 54. GMCH Ballout Arranged by Signal Name

| Signal Names | Ball # | X[mils] | Y[mils] |
|--------------|--------|---------|---------|
| VSS | BE25 | -66 | 642.3 |
| VSS | BE29 | -198 | 642.3 |
| VSS | BE34 | -330 | 642.3 |
| VSS | BE40 | -527.9 | 642.3 |
| DDR_A_DQ_6 | BE6 | 527.9 | 642.3 |
| VSS | C3 | 578.3 | -578.3 |
| VSS | C5 | 551 | -589.9 |
| PEG_TXN_3 | C7 | 495 | -592 |
| VSS | D11 | 363 | -560.6 |
| VSS | D16 | 231 | -560.6 |
| VSS | D21 | 64 | -559.1 |
| VSS | D25 | -64 | -559.1 |
| VSS | D26 | -99 | -560.6 |
| VSS | D39 | -492 | -560.6 |
| VSS | D6 | 523 | -576.3 |
| VSS | D7 | 492 | -560.6 |
| PEG_TXN_2 | D8 | 460.5 | -559.1 |
| VSS | E3 | 589.9 | -551 |
| VSS | E31 | -264 | -547.7 |
| VSS | E41 | -544.9 | -544.9 |
| VSS | E5 | 544.9 | -544.9 |
| VSS | F16 | 223.5 | -514.5 |
| VSS | F2 | 609 | -525.8 |
| VSS | F30 | -223.5 | -514.5 |
| VSS | F4 | 576.3 | -523 |
| VSS | F42 | -576.3 | -523 |
| VSS | F45 | -642.3 | -527.9 |
| VSS | F8 | 465.5 | -526.9 |
| VSS | G11 | 369.5 | -486.5 |
| VSS | G17 | 172.5 | -486.5 |
| VSS | G24 | -19.5 | -486.5 |
| VSS | G26 | -121.5 | -486.5 |
| VSS | G29 | -172.5 | -486.5 |
| VSS | G3 | 592 | -495 |
| VSS | G35 | -369.5 | -486.5 |
| VSS | H1 | 642.3 | -463.2 |
| VSS | H11 | 369.5 | -458.5 |
| VSS | H13 | 321.5 | -458.5 |
| VSS | H15 | 274.5 | -458.5 |
| VSS | H16 | 223.5 | -458.5 |
| VSS | H20 | 121.5 | -458.5 |
| VSS | H25 | -70.5 | -458.5 |
| VSS | H30 | -223.5 | -458.5 |



Table 54. GMCH Ballout Arranged by Signal Name

| Signal Names | Ball # | X[mils] | Y[mils] |
|--------------|--------|---------|---------|
| VSS | H31 | -274.5 | -458.5 |
| VSS | H33 | -321.5 | -458.5 |
| VSS | H38 | -462.5 | -462.5 |
| VSS | H44 | -609.3 | -462 |
| VSS | H7 | 497.4 | -463 |
| VSS | H8 | 462.5 | -462.5 |
| VSS | H9 | 417.5 | -458.5 |
| VSS | J3 | 592.1 | -429 |
| VSS | J37 | -418 | -418 |
| VSS | J4 | 564.5 | -429 |
| VSS | J5 | 539.1 | -439.8 |
| VSS | J8 | 458.5 | -417.5 |
| VSS | J9 | 418 | -418 |
| VSS | K13 | 321.5 | -402.5 |
| VSS | K17 | 172.5 | -402.5 |
| VSS | K20 | 121.5 | -402.5 |
| VSS | K24 | -19.5 | -402.5 |
| VSS | K29 | -172.5 | -402.5 |
| VSS | K33 | -321.5 | -402.5 |
| VSS | K45 | -642.3 | -396 |
| VSS | L10 | 401.3 | -369.5 |
| VSS | L16 | 223.5 | -374.5 |
| VSS | L20 | 121.5 | -374.5 |
| VSS | L26 | -121.5 | -374.5 |
| VSS | L30 | -223.5 | -374.5 |
| VSS | L35 | -357.9 | -357.9 |
| VSS | L39 | -486.5 | -369.5 |
| VSS | L4 | 560.6 | -363 |
| VSS | L8 | 458.5 | -369.5 |
| VSS | L9 | 430.5 | -369.5 |
| VSS | M1 | 642.3 | -330 |
| VSS | M24 | -19.5 | -346.5 |
| VSS | M25 | -70.5 | -346.5 |
| VSS | M44 | -609.3 | -330 |
| VSS | N11 | 371.4 | -321.5 |
| VSS | N13 | 321.4 | -321.4 |
| VSS | N26 | -121.5 | -318.9 |
| VSS | N29 | -172.5 | -318.9 |
| VSS | N33 | -321.4 | -321.4 |
| VSS | N36 | -402.5 | -321.5 |
| VSS | N38 | -458.5 | -321.5 |
| VSS | N8 | 458.5 | -321.5 |
| VSS | P25 | -70.5 | -290.9 |

Table 54. GMCH Ballout Arranged by Signal Name

| Signal Names | Ball # | X[mils] | Y[mils] |
|--------------|--------|---------|---------|
| VSS | P26 | -121.5 | -290.9 |
| VSS | R11 | 374.5 | -274.5 |
| VSS | R12 | 346.5 | -274.5 |
| VSS | R2 | 608.8 | -264 |
| VSS | R38 | -458.5 | -274.5 |
| VSS | R45 | -642.3 | -264 |
| VSS | R5 | 547.7 | -264 |
| VSS | R8 | 458.5 | -274.5 |
| VSS | T10 | 402.5 | -223.5 |
| VSS | T11 | 374.5 | -223.5 |
| VSS | T12 | 346.5 | -223.5 |
| VSS | T13 | 318.9 | -223.5 |
| VSS | T3 | 592.1 | -231 |
| VSS | T35 | -374.5 | -223.5 |
| VSS | T38 | -458.5 | -223.5 |
| VSS | T4 | 560.6 | -231 |
| VSS | T40 | -514.5 | -223.5 |
| VSS | T6 | 514.5 | -223.5 |
| VSS | T7 | 486.5 | -223.5 |
| VSS | T8 | 458.5 | -223.5 |
| VSS | T9 | 430.5 | -223.5 |
| VSS | U1 | 642.3 | -198 |
| VSS | U11 | 374.5 | -172.5 |
| VSS | U12 | 346.5 | -172.5 |
| VSS | U13 | 318.9 | -172.5 |
| VSS | U36 | -402.5 | -172.5 |
| VSS | U39 | -486.5 | -172.5 |
| VSS | U44 | -609.3 | -198 |
| VSS | U8 | 458.5 | -172.5 |
| VSS | W1 | 642.3 | -132 |
| VSS | W2 | 608.8 | -132 |
| VSS | W20 | 109.2 | -145.6 |
| VSS | W22 | 36.4 | -145.6 |
| VSS | W24 | -36.4 | -145.6 |
| VSS | W26 | -109.2 | -145.6 |
| VSS | W45 | -642.3 | -132 |
| VSS | W5 | 547.7 | -132 |
| VSS | Y10 | 402.5 | -121.5 |
| VSS | Y11 | 374.5 | -121.5 |
| VSS | Y12 | 346.5 | -121.5 |
| VSS | Y13 | 318.9 | -121.5 |
| VSS | Y19 | 145.6 | -109.2 |
| VSS | Y2 | 625.6 | -99 |

Table 54. GMCH Ballout Arranged by Signal Name

| Signal Names | Ball # | X[mils] | Y[mils] |
|--------------|--------|---------|---------|
| VSS | Y21 | 72.8 | -109.2 |
| VSS | Y23 | 0 | -109.2 |
| VSS | Y25 | -72.8 | -109.2 |
| VSS | Y27 | -145.6 | -109.2 |
| VSS | Y3 | 592.1 | -99 |
| VSS | Y35 | -374.5 | -121.5 |
| VSS | Y39 | -486.5 | -121.5 |
| VSS | Y9 | 430.5 | -121.5 |
| VCC_CL | AA31 | -254.8 | -72.8 |
| VCC_CL | AB31 | -254.8 | -36.4 |
| VCC_CL | AC31 | -254.8 | 0 |
| VCC_CL | AD31 | -254.8 | 36.4 |
| VCC_CL | AE31 | -254.8 | 72.8 |
| VCC_CL | AF31 | -254.8 | 109.2 |
| VCC_CL | AG30 | -218.4 | 145.6 |
| VCC_CL | AG31 | -254.8 | 145.6 |
| VCC_CL | AJ30 | -218.4 | 182 |
| VCC_CL | AJ31 | -254.8 | 182 |
| VCC_CL | AK16 | 218.4 | 218.4 |
| VCC_CL | AK17 | 182 | 218.4 |
| VCC_CL | AK19 | 145.6 | 218.4 |
| VCC_CL | AK20 | 109.2 | 218.4 |
| VCC_CL | AK21 | 72.8 | 218.4 |
| VCC_CL | AK22 | 36.4 | 218.4 |
| VCC_CL | AK23 | 0 | 218.4 |
| VCC_CL | AK24 | -36.4 | 218.4 |
| VCC_CL | AK25 | -72.8 | 218.4 |
| VCC_CL | AK26 | -109.2 | 218.4 |
| VCC_CL | AK27 | -145.6 | 218.4 |
| VCC_CL | AK29 | -182 | 218.4 |
| VCC_CL | AK30 | -218.4 | 218.4 |
| VCC_CL | AL1 | 642.3 | 264 |
| VCC_CL | AL10 | 402.5 | 274.5 |
| VCC_CL | AL11 | 374.5 | 274.5 |
| VCC_CL | AL12 | 346.5 | 274.5 |
| VCC_CL | AL14 | 290.5 | 269.3 |
| VCC_CL | AL15 | 254.8 | 254.8 |
| VCC_CL | AL16 | 218.4 | 254.8 |
| VCC_CL | AL17 | 182 | 254.8 |
| VCC_CL | AL19 | 145.6 | 254.8 |
| VCC_CL | AL2 | 608.8 | 264 |
| VCC_CL | AL20 | 109.2 | 254.8 |
| VCC_CL | AL21 | 72.8 | 254.8 |

Table 54. GMCH Ballout Arranged by Signal Name

| Signal Names | Ball # | X[mils] | Y[mils] |
|--------------|--------|---------|---------|
| VCC_CL | AL22 | 36.4 | 254.8 |
| VCC_CL | AL23 | 0 | 254.8 |
| VCC_CL | AL24 | -36.4 | 254.8 |
| VCC_CL | AL25 | -72.8 | 254.8 |
| VCC_CL | AL26 | -109.2 | 254.8 |
| VCC_CL | AL27 | -145.6 | 254.8 |
| VCC_CL | AL29 | -182 | 254.8 |
| VCC_CL | AL4 | 575.3 | 264 |
| VCC_CL | AL5 | 547.7 | 264 |
| VCC_CL | AL6 | 514.5 | 274.5 |
| VCC_CL | AL7 | 486.5 | 274.5 |
| VCC_CL | AL8 | 458.5 | 274.5 |
| VCC_CL | AL9 | 430.5 | 274.5 |
| VCC_CL | AM2 | 625.6 | 297 |
| VCC_CL | AM3 | 592.1 | 297 |
| VCC_CL | AM4 | 560.6 | 297 |
| VCC_CL | AP1 | 642.3 | 330 |
| VCC_CL | AP2 | 609.3 | 330 |
| VCC_CL | W31 | -254.8 | -145.6 |
| VCC_CL | Y31 | -254.8 | -109.2 |
| VCC_CL | Y29 | -182 | -109.2 |
| VCC_CL | Y30 | -218.4 | -109.2 |
| VCCDQ_CRT | B20 | 99 | -625.6 |
| VCCDPLL_EXP | B12 | 330 | -609.3 |
| VCCD_HPLL | U33 | -318.9 | -172.5 |
| VCCCMML_DDR | AM30 | -223.5 | 290.9 |
| VCC_SMCLK | AK32 | -290.9 | 223.5 |
| VCC_SMCLK | AL31 | -254.8 | 254.8 |
| VCC_SMCLK | AL32 | -290.5 | 269.3 |
| VCC_SMCLK | AM31 | -269.3 | 290.5 |
| VCCAVRM_EXP | AG2 | 608.8 | 132 |
| VCCAPLL_EXP | B16 | 231 | -625.6 |
| VCC_CL | AJ27 | -145.6 | 182 |
| VCC_CL | AJ29 | -182 | 182 |
| VCCA_EXP | A17 | 198 | -642.3 |
| VCCA_MPLL | A21 | 66 | -642.3 |
| VCCA_HPLL | B22 | 33 | -625.6 |
| VCC_CL | AA32 | -290.9 | -70.5 |
| VCC_CL | AA33 | -318.9 | -70.5 |
| VCC_CL | AB32 | -290.9 | -19.5 |
| VCC_CL | AB33 | -318.9 | -19.5 |
| VCC_CL | AD32 | -290.9 | 19.5 |
| VCC_CL | AD33 | -318.9 | 19.5 |

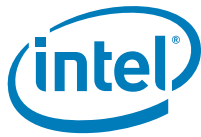

Table 54. GMCH Ballout Arranged by Signal Name

| Signal Names | Ball # | X[mils] | Y[mils] |
|--------------|--------|---------|---------|
| VCC_CL | AE32 | -290.9 | 70.5 |
| VCC_CL | AE33 | -318.9 | 70.5 |
| VCC_CL | AF32 | -290.9 | 121.5 |
| VCC_CL | AJ32 | -290.9 | 172.5 |
| VCC_CL | AK31 | -254.8 | 218.4 |
| VCC_CL | AL30 | -218.4 | 254.8 |
| VCC_CL | AM15 | 269.3 | 290.5 |
| VCC_CL | AM16 | 223.5 | 290.9 |
| VCC_CL | AM17 | 172.5 | 290.9 |
| VCC_CL | AM20 | 121.5 | 290.9 |
| VCC_CL | AM21 | 70.5 | 290.9 |
| VCC_CL | AM22 | 19.5 | 290.9 |
| VCC_CL | AM24 | -19.5 | 290.9 |
| VCC_CL | AM25 | -70.5 | 290.9 |
| VCC_CL | AM26 | -121.5 | 290.9 |
| VCC_CL | AM29 | -172.5 | 290.9 |
| VCC_CL | Y32 | -290.9 | -121.5 |
| VCC_CL | Y33 | -318.9 | -121.5 |
| VCCA_DAC | B19 | 132 | -608.8 |
| VCCA_DAC | D19 | 132 | -575.3 |
| VCCA_DPLL B | C20 | 99 | -592.1 |
| VCCA_DPLL A | D20 | 99 | -560.6 |
| VCC_EXP | AA14 | 290.9 | -70.5 |
| VCC_EXP | AA15 | 254.8 | -72.8 |
| VCC_EXP | AB14 | 290.9 | -19.5 |
| VCC_EXP | AC15 | 254.8 | 0 |
| VCC | AC4 | 575.3 | 0 |
| VCC_EXP | AD14 | 290.9 | 19.5 |
| VCC_EXP | AD15 | 254.8 | 36.4 |
| VCC_EXP | AE14 | 290.9 | 70.5 |
| VCC_EXP | AE15 | 254.8 | 72.8 |
| VCC_EXP | AF14 | 290.9 | 121.5 |
| VCC_EXP | AF15 | 254.8 | 109.2 |
| VCC | AF3 | 592.1 | 99 |
| VCC_EXP | AG15 | 254.8 | 145.6 |
| VCC_EXP | AJ10 | 402.5 | 172.5 |
| VCC_EXP | AJ11 | 374.5 | 172.5 |
| VCC_EXP | AJ12 | 346.5 | 172.5 |
| VCC_EXP | AJ13 | 318.9 | 172.5 |
| VCC_EXP | AJ14 | 290.9 | 172.5 |
| VCC_EXP | AJ6 | 514.5 | 172.5 |
| VCC_EXP | AJ7 | 486.5 | 172.5 |
| VCC_EXP | AJ8 | 458.5 | 172.5 |

Table 54. GMCH Ballout Arranged by Signal Name

| Signal Names | Ball # | X[mils] | Y[mils] |
|--------------|--------|---------|---------|
| VCC_EXP | AJ9 | 430.5 | 172.5 |
| VCC_EXP | AK10 | 402.5 | 223.5 |
| VCC_EXP | AK11 | 374.5 | 223.5 |
| VCC_EXP | AK12 | 346.5 | 223.5 |
| VCC_EXP | AK13 | 318.9 | 223.5 |
| VCC_EXP | AK6 | 514.5 | 223.5 |
| VCC_EXP | AK7 | 486.5 | 223.5 |
| VCC_EXP | AK8 | 458.5 | 223.5 |
| VCC_EXP | AK9 | 430.5 | 223.5 |
| VCC | F9 | 417.5 | -520.5 |
| VCC | H4 | 559.1 | -460.5 |
| VCC | L3 | 592.1 | -363 |
| VCC | P3 | 592.1 | -297 |
| VCC_EXP | U14 | 290.9 | -172.5 |
| VCC_EXP | U15 | 254.8 | -182 |
| VCC | V4 | 560.6 | -165 |
| VCC_EXP | W15 | 254.8 | -145.6 |
| VCC_EXP | Y14 | 290.9 | -121.5 |
| VCC_EXP | Y15 | 254.8 | -109.2 |
| VCC_CL | AJ15 | 254.8 | 182 |
| VCC_CL | AK14 | 290.9 | 223.5 |
| VCC3_3 | E19 | 132 | -547.7 |
| VCC_EXP | AJ1 | 642.3 | 198 |
| VCC_EXP | AJ2 | 609.3 | 198 |
| VCC_EXP | AK2 | 625.6 | 231 |
| VCC_EXP | AK3 | 592.1 | 231 |
| VCC_EXP | AK4 | 560.6 | 231 |
| VCC_SM | AP44 | -609.3 | 330 |
| VCC_SM | AT45 | -642.3 | 396 |
| VCC_SM | AV44 | -609.3 | 462 |
| VCC_SM | AY40 | -525.3 | 525.3 |
| VCC_SM | BA41 | -544.9 | 544.9 |
| VCC_SM | BB39 | -492 | 560.6 |
| VCC_SM | BD21 | 66 | 609.3 |
| VCC_SM | BD25 | -66 | 609.3 |
| VCC_SM | BD29 | -198 | 609.3 |
| VCC_SM | BD34 | -330 | 609.3 |
| VCC_SM | BD38 | -462 | 609.3 |
| VCC_SM | BE23 | 0 | 642.3 |
| VCC_SM | BE27 | -132 | 642.3 |
| VCC_SM | BE31 | -264 | 642.3 |
| VCC_SM | BE36 | -396 | 642.3 |
| VCC_HDA | AR2 | 625.6 | 363 |



Table 54. GMCH Ballout Arranged by Signal Name

| Signal Names | Ball # | X[mils] | Y[mils] |
|--------------|--------|---------|---------|
| VSS | AA16 | 218.4 | -72.8 |
| VSS | AA17 | 182 | -72.8 |
| VCC | AA19 | 145.6 | -72.8 |
| VCC | AA21 | 72.8 | -72.8 |
| VCC | AA23 | 0 | -72.8 |
| VCC | AA25 | -72.8 | -72.8 |
| VCC | AA27 | -145.6 | -72.8 |
| VCC | AA29 | -182 | -72.8 |
| VCC | AA30 | -218.4 | -72.8 |
| VSS | AB16 | 218.4 | -36.4 |
| VSS | AB17 | 182 | -36.4 |
| VCC | AB20 | 109.2 | -36.4 |
| VCC | AB22 | 36.4 | -36.4 |
| VCC | AB24 | -36.4 | -36.4 |
| VCC | AB26 | -109.2 | -36.4 |
| VCC | AB29 | -182 | -36.4 |
| VCC | AB30 | -218.4 | -36.4 |
| VCC | AC16 | 218.4 | 0 |
| VCC | AC17 | 182 | 0 |
| VCC | AC19 | 145.6 | 0 |
| VCC | AC21 | 72.8 | 0 |
| VCC | AC23 | 0 | 0 |
| VCC | AC25 | -72.8 | 0 |
| VCC | AC27 | -145.6 | 0 |
| VCC | AC29 | -182 | 0 |
| VCC | AD16 | 218.4 | 36.4 |
| VCC | AD17 | 182 | 36.4 |
| VCC | AD20 | 109.2 | 36.4 |
| VCC | AD22 | 36.4 | 36.4 |
| VCC | AD24 | -36.4 | 36.4 |
| VCC | AD26 | -109.2 | 36.4 |
| VCC | AD29 | -182 | 36.4 |
| VCC | AE16 | 218.4 | 72.8 |
| VCC | AE17 | 182 | 72.8 |
| VCC | AE19 | 145.6 | 72.8 |
| VCC | AE21 | 72.8 | 72.8 |
| VCC | AE23 | 0 | 72.8 |
| VCC | AE25 | -72.8 | 72.8 |
| VCC | AE27 | -145.6 | 72.8 |
| VCC | AE29 | -182 | 72.8 |
| VCC | AF16 | 218.4 | 109.2 |
| VCC | AF17 | 182 | 109.2 |
| VCC | AF19 | 145.6 | 109.2 |

Table 54. GMCH Ballout Arranged by Signal Name

| Signal Names | Ball # | X[mils] | Y[mils] |
|--------------|--------|---------|---------|
| VCC | AF20 | 109.2 | 109.2 |
| VCC | AF21 | 72.8 | 109.2 |
| VCC | AF22 | 36.4 | 109.2 |
| VCC | AF23 | 0 | 109.2 |
| VCC | AF24 | -36.4 | 109.2 |
| VCC | AF25 | -72.8 | 109.2 |
| VCC | AF26 | -109.2 | 109.2 |
| VCC | AF27 | -145.6 | 109.2 |
| VCC | AF29 | -182 | 109.2 |
| VCC | AG16 | 218.4 | 145.6 |
| VCC | AG17 | 182 | 145.6 |
| VCC | AG20 | 109.2 | 145.6 |
| VCC | AG22 | 36.4 | 145.6 |
| VCC | AG24 | -36.4 | 145.6 |
| VCC | AG26 | -109.2 | 145.6 |
| VCC | AG29 | -182 | 145.6 |
| VCC | AJ16 | 218.4 | 182 |
| VCC | AJ17 | 182 | 182 |
| VCC | AJ19 | 145.6 | 182 |
| VCC | AJ21 | 72.8 | 182 |
| VCC | AJ23 | 0 | 182 |
| VCC | AJ25 | -72.8 | 182 |
| VSS | N16 | 223.5 | -318.9 |
| VSS | P16 | 223.5 | -290.9 |
| VSS | P17 | 172.5 | -290.9 |
| VSS | R16 | 218.4 | -254.8 |
| VSS | R17 | 182 | -254.8 |
| VSS | R19 | 145.6 | -254.8 |
| VCC | R25 | -72.8 | -254.8 |
| VCC | R26 | -109.2 | -254.8 |
| VCC | R27 | -145.6 | -254.8 |
| VCC | R29 | -182 | -254.8 |
| VSS | R30 | -218.4 | -254.8 |
| VSS | T16 | 218.4 | -218.4 |
| VSS | T17 | 182 | -218.4 |
| VSS | T19 | 145.6 | -218.4 |
| VSS | T20 | 109.2 | -218.4 |
| VCC | T21 | 72.8 | -218.4 |
| VCC | T24 | -36.4 | -218.4 |
| VCC | T25 | -72.8 | -218.4 |
| VCC | T26 | -109.2 | -218.4 |
| VCC | T27 | -145.6 | -218.4 |
| VCC | T29 | -182 | -218.4 |

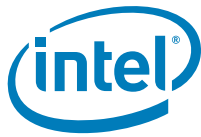

Table 54. GMCH Ballout Arranged by Signal Name

| Signal Names | Ball # | X[mils] | Y[mils] |
|---------------|--------|---------|---------|
| VSS | T30 | -218.4 | -218.4 |
| VSS | U16 | 218.4 | -182 |
| VSS | U17 | 182 | -182 |
| VSS | U19 | 145.6 | -182 |
| VSS | U20 | 109.2 | -182 |
| VCC | U21 | 72.8 | -182 |
| VCC | U22 | 36.4 | -182 |
| VCC | U23 | 0 | -182 |
| VCC | U24 | -36.4 | -182 |
| VCC | U25 | -72.8 | -182 |
| VCC | U26 | -109.2 | -182 |
| VCC | U27 | -145.6 | -182 |
| VCC | U29 | -182 | -182 |
| VSS | W16 | 218.4 | -145.6 |
| VSS | W17 | 182 | -145.6 |
| VCC | W19 | 145.6 | -145.6 |
| VCC | W21 | 72.8 | -145.6 |
| VCC | W23 | 0 | -145.6 |
| VCC | W25 | -72.8 | -145.6 |
| VCC | W27 | -145.6 | -145.6 |
| VCC | W29 | -182 | -145.6 |
| NC | W30 | -218.4 | -145.6 |
| VSS | Y16 | 218.4 | -109.2 |
| VSS | Y17 | 182 | -109.2 |
| VCC | Y20 | 109.2 | -109.2 |
| VCC | Y22 | 36.4 | -109.2 |
| VCC | Y24 | -36.4 | -109.2 |
| VCC | Y26 | -109.2 | -109.2 |
| NC | B14 | 297 | -625.6 |
| NC | AK15 | 254.8 | 218.4 |
| NC | AE30 | -218.4 | 72.8 |
| NC | AF30 | -218.4 | 109.2 |
| NC | AC30 | -218.4 | 0 |
| NC | AD30 | -218.4 | 36.4 |
| SDVO_CTRLDATA | J13 | 321.5 | -430.5 |
| SDVO_CTRLCLK | G13 | 321.5 | -486.5 |
| RSVD | A45 | -642.3 | -642.3 |
| RSVD | B2 | 610.8 | -610.8 |
| RSVD | BE1 | 642.3 | 642.3 |
| RSVD | BE45 | -642.3 | 642.3 |
| RSTINB | AN6 | 520.5 | 321.5 |
| PWROK | AR4 | 560.6 | 363 |
| SLPB | P42 | -560.6 | -297 |

Table 54. GMCH Ballout Arranged by Signal Name

| Signal Names | Ball # | X[mils] | Y[mils] |
|--------------|--------|---------|---------|
| RSVD | L13 | 321.5 | -371.4 |
| DPRSTPB | P43 | -592.1 | -297 |
| RSVD | L11 | 357.9 | -357.9 |
| PEG_TXP_9 | K1 | 642.3 | -396 |
| PEG_TXP_8 | J2 | 625.6 | -429 |
| PEG_TXP_7 | H2 | 609.3 | -462 |
| PEG_TXP_6 | D2 | 624 | -553.6 |
| PEG_TXP_5 | B3 | 579.6 | -605.9 |
| PEG_TXP_4 | B7 | 497.9 | -623.9 |
| VSS | A8 | 463.2 | -642.3 |
| PEG_TXN_1 | B9 | 429 | -625.6 |
| PEG_TXP_15 | AC1 | 642.3 | 0 |
| PEG_TXP_14 | AA4 | 559.1 | -64 |
| PEG_TXP_13 | W4 | 575.3 | -132 |
| PEG_TXP_12 | U2 | 609.3 | -198 |
| PEG_TXP_11 | T2 | 625.6 | -231 |
| PEG_TXP_10 | P2 | 625.6 | -297 |
| PEG_TXP_1 | A10 | 396 | -642.3 |
| PEG_TXP_0 | C11 | 363 | -592.1 |
| PEG_TXN_9 | L2 | 625.6 | -363 |
| PEG_TXN_8 | K2 | 608.8 | -396 |
| PEG_TXN_7 | G2 | 623.9 | -497.9 |
| PEG_TXN_6 | C2 | 605.9 | -579.6 |
| PEG_TXN_5 | B4 | 553.6 | -624 |
| PEG_TXN_4 | B6 | 525.8 | -609 |
| PEG_TXP_3 | B8 | 462 | -609.3 |
| PEG_TXP_2 | C9 | 429 | -592.1 |
| PEG_TXN_15 | AB2 | 625.6 | -33 |
| PEG_TXN_14 | Y4 | 560.6 | -99 |
| PEG_TXN_13 | V3 | 592.1 | -165 |
| PEG_TXN_12 | V2 | 625.6 | -165 |
| PEG_TXN_11 | R1 | 642.3 | -264 |
| PEG_TXN_10 | M2 | 609.3 | -330 |
| VSS | B10 | 396 | -608.8 |
| PEG_TXN_0 | B11 | 363 | -625.6 |
| PEG_RXP_9 | U6 | 514.5 | -172.5 |
| PEG_RXP_8 | U10 | 402.5 | -172.5 |
| PEG_RXP_7 | R9 | 430.5 | -274.5 |
| PEG_RXP_6 | R7 | 486.5 | -274.5 |
| PEG_RXP_5 | N7 | 486.5 | -321.5 |
| PEG_RXP_4 | N9 | 430.5 | -321.5 |
| PEG_RXP_3 | L6 | 520.5 | -369.5 |
| PEG_RXP_2 | J6 | 520.5 | -417.5 |



Table 54. GMCH Ballout Arranged by Signal Name

| Signal Names | Ball # | X[mils] | Y[mils] |
|---------------|--------|---------|---------|
| PEG_RXP_15 | AD10 | 402.5 | 19.5 |
| PEG_RXP_14 | AB3 | 592.1 | -33 |
| PEG_RXP_13 | AB10 | 402.5 | -19.5 |
| PEG_RXP_12 | AA7 | 486.5 | -70.5 |
| PEG_RXP_11 | R4 | 575.3 | -264 |
| PEG_RXP_10 | AA9 | 430.5 | -70.5 |
| PEG_RXP_1 | H6 | 526.9 | -465.5 |
| PEG_RXP_0 | F6 | 525.3 | -525.3 |
| PEG_RXN_9 | U7 | 486.5 | -172.5 |
| PEG_RXN_8 | U9 | 430.5 | -172.5 |
| PEG_RXN_7 | R10 | 402.5 | -274.5 |
| PEG_RXN_6 | R6 | 514.5 | -274.5 |
| PEG_RXN_5 | N6 | 520.5 | -321.5 |
| PEG_RXN_4 | N10 | 402.5 | -321.5 |
| PEG_RXN_3 | L7 | 486.5 | -369.5 |
| PEG_RXN_2 | J7 | 486.5 | -417.5 |
| PEG_RXN_15 | AD11 | 374.5 | 19.5 |
| PEG_RXN_14 | AA2 | 609.3 | -66 |
| PEG_RXN_13 | AB9 | 430.5 | -19.5 |
| PEG_RXN_12 | AA6 | 514.5 | -70.5 |
| PEG_RXN_11 | P4 | 560.6 | -297 |
| PEG_RXN_10 | AA10 | 402.5 | -70.5 |
| PEG_RXN_1 | G4 | 560.6 | -492 |
| PEG_RXN_0 | G7 | 505.7 | -505.7 |
| ITPM_ENB | L17 | 172.5 | -374.5 |
| EXP_SM | H17 | 172.5 | -458.5 |
| RSVD | G15 | 274.5 | -486.5 |
| EXP_SLR | F15 | 274.5 | -514.5 |
| RSVD | K16 | 223.5 | -402.5 |
| XORTEST | N17 | 172.5 | -318.9 |
| ALLZTEST | M20 | 121.5 | -346.5 |
| BSEL2 | P15 | 269.3 | -290.5 |
| DualX8_Enable | F20 | 121.5 | -514.5 |
| RSVD | J20 | 121.5 | -430.5 |
| RSVD | J15 | 274.5 | -430.5 |
| RSVD | M16 | 223.5 | -346.5 |
| RSVD | J16 | 223.5 | -430.5 |
| BSCANTEST | G20 | 121.5 | -486.5 |
| CEN | J17 | 172.5 | -430.5 |
| RSVD | M17 | 172.5 | -346.5 |
| BSEL1 | G16 | 223.5 | -486.5 |
| BSELO | F17 | 172.5 | -514.5 |
| NC | A44 | -610.8 | -642.3 |

Table 54. GMCH Ballout Arranged by Signal Name

| Signal Names | Ball # | X[mils] | Y[mils] |
|--------------|--------|---------|---------|
| NC | BD1 | 642.3 | 610.8 |
| NC | BD45 | -642.3 | 610.8 |
| NC | BE2 | 610.8 | 642.3 |
| NC | BE44 | -610.8 | 642.3 |
| DDR_A_DQS_5 | AD43 | -592.1 | 33 |
| NC | AN16 | 223.5 | 318.9 |
| VSS | AN26 | -121.5 | 318.9 |
| VSS | AP21 | 70.5 | 346.5 |
| VSS | AP25 | -70.5 | 346.5 |
| VSS | AR13 | 321.5 | 371.4 |
| VSS | AR3 | 592.1 | 363 |
| VSS | AU5 | 539.1 | 439.8 |
| VSS | AU6 | 520.5 | 417.5 |
| VSS | AV11 | 369.5 | 458.5 |
| DDR_B_CKB_5 | AV35 | -369.5 | 458.5 |
| VSS | AV6 | 526.9 | 465.5 |
| VSS | AV9 | 417.5 | 458.5 |
| NC | AW44 | -623.9 | 497.9 |
| VSS | BD43 | -579.6 | 605.9 |
| VSS | K11 | 369.5 | -401.3 |
| VSS | N30 | -223.5 | -318.9 |
| VSS | P31 | -269.3 | -290.5 |
| NC | R42 | -575.3 | -264 |
| VSS | T31 | -254.8 | -218.4 |
| VSS | T32 | -290.9 | -223.5 |
| VSS | T33 | -318.9 | -223.5 |
| NC | U32 | -290.9 | -172.5 |
| VSS | W44 | -608.8 | -132 |
| CL_VREF | AN13 | 321.4 | 321.4 |
| CL_RSTB | AW2 | 623.9 | 497.9 |
| CL_DATA | AY4 | 576.3 | 523 |
| CL_CLK | AY2 | 609 | 525.8 |
| CL_PWROK | AN8 | 458.5 | 321.5 |
| NC | B45 | -642.3 | -610.8 |
| ICH_SYNCB | K15 | 274.5 | -402.5 |
| VTT_FSB | R22 | 36.4 | -254.8 |
| VTT_FSB | R21 | 72.8 | -254.8 |
| VSS | AN22 | 19.5 | 318.9 |
| VSS | AN21 | 70.5 | 318.9 |
| VCC | T23 | 0 | -218.4 |
| VCC | T22 | 36.4 | -218.4 |
| VSS | AE13 | 318.9 | 70.5 |
| VSS | AE12 | 346.5 | 70.5 |

Table 54. GMCH Ballout Arranged by Signal Name

| Signal Names | Ball # | X[mils] | Y[mils] |
|---------------|--------|---------|---------|
| VSS | AN24 | -19.5 | 318.9 |
| VSS | AN25 | -70.5 | 318.9 |
| JTAG_TMS | AN9 | 430.5 | 321.5 |
| JTAG_TDO | AN10 | 402.5 | 321.5 |
| JTAG_TDI | AR7 | 486.5 | 369.5 |
| JTAG_TCK | AN11 | 371.4 | 321.5 |
| RSVD | U30 | -218.4 | -182 |
| RSVD | U31 | -254.8 | -182 |
| RSVD | R31 | -254.8 | -254.8 |
| RSVD | R32 | -290.5 | -269.3 |
| HPL_CLKINP | P29 | -172.5 | -290.9 |
| HPL_CLKINN | P30 | -223.5 | -290.9 |
| FSB_TRDYB | L40 | -520.5 | -369.5 |
| FSB_SWING | B24 | -33 | -625.6 |
| FSB_RSB_2 | G42 | -560.6 | -492 |
| FSB_RSB_1 | L44 | -625.6 | -363 |
| FSB_RSB_0 | G43 | -592 | -495 |
| FSB_REQB_4 | G39 | -505.7 | -505.7 |
| FSB_REQB_3 | C43 | -578.3 | -578.3 |
| FSB_REQB_2 | J39 | -486.5 | -417.5 |
| FSB_REQB_1 | K35 | -369.5 | -401.3 |
| FSB_REQB_0 | G38 | -463 | -497.4 |
| FSB_RCOMP | A23 | 0 | -642.3 |
| RSVD | N25 | -70.5 | -318.9 |
| FSB_LOCKB | H40 | -526.9 | -465.5 |
| FSB_HITMB | K44 | -608.8 | -396 |
| FSB_HITB | H45 | -642.3 | -463.2 |
| FSB_DVREF | C22 | 33 | -592.1 |
| FSB_DSTBPPB_3 | C32 | -297 | -592.1 |
| FSB_DSTBPPB_2 | J25 | -70.5 | -430.5 |
| FSB_DSTBPPB_1 | K31 | -274.5 | -402.5 |
| FSB_DSTBPPB_0 | C39 | -495 | -592 |
| FSB_DSTBPNB_3 | D32 | -297 | -560.6 |
| FSB_DSTBPNB_2 | K25 | -70.5 | -402.5 |
| FSB_DSTBPNB_1 | J31 | -274.5 | -430.5 |
| FSB_DSTBPNB_0 | B39 | -497.9 | -623.9 |
| FSB_DRDYB | J43 | -592.1 | -429 |
| FSB_DINVB_3 | D30 | -231 | -560.6 |
| FSB_DINVB_2 | F26 | -121.5 | -514.5 |
| FSB_DINVB_1 | F33 | -321.5 | -520.5 |
| FSB_DINVB_0 | B40 | -525.8 | -609 |
| FSB_DEFERB | G44 | -623.9 | -497.9 |
| FSB_DBSYB | H42 | -559.1 | -460.5 |

Table 54. GMCH Ballout Arranged by Signal Name

| Signal Names | Ball # | X[mils] | Y[mils] |
|--------------|--------|---------|---------|
| FSB_DB_9 | F38 | -465.5 | -526.9 |
| FSB_DB_8 | B38 | -462 | -609.3 |
| FSB_DB_7 | B42 | -553.6 | -624 |
| FSB_DB_63 | B28 | -165 | -625.6 |
| FSB_DB_62 | E27 | -132 | -547.7 |
| FSB_DB_61 | B30 | -231 | -625.6 |
| FSB_DB_60 | C30 | -231 | -592.1 |
| FSB_DB_6 | D40 | -523 | -576.3 |
| FSB_DB_59 | A29 | -198 | -642.3 |
| FSB_DB_58 | D28 | -165 | -560.6 |
| FSB_DB_57 | F31 | -274.5 | -514.5 |
| FSB_DB_56 | B32 | -297 | -625.6 |
| FSB_DB_55 | A34 | -330 | -642.3 |
| FSB_DB_54 | D31 | -264 | -575.3 |
| FSB_DB_53 | D35 | -363 | -560.6 |
| FSB_DB_52 | B35 | -363 | -625.6 |
| FSB_DB_51 | C35 | -363 | -592.1 |
| FSB_DB_50 | F35 | -369.5 | -520.5 |
| FSB_DB_5 | B43 | -579.6 | -605.9 |
| FSB_DB_49 | B31 | -264 | -608.8 |
| FSB_DB_48 | C28 | -165 | -592.1 |
| FSB_DB_47 | N24 | -19.5 | -318.9 |
| FSB_DB_46 | J24 | -19.5 | -430.5 |
| FSB_DB_45 | L24 | -19.5 | -374.5 |
| FSB_DB_44 | H24 | -19.5 | -458.5 |
| FSB_DB_43 | G25 | -70.5 | -486.5 |
| FSB_DB_42 | F24 | -19.5 | -514.5 |
| FSB_DB_41 | F25 | -70.5 | -514.5 |
| FSB_DB_40 | H26 | -121.5 | -458.5 |
| FSB_DB_4 | E43 | -589.9 | -551 |
| FSB_DB_39 | M26 | -121.5 | -346.5 |
| FSB_DB_38 | J26 | -121.5 | -430.5 |
| FSB_DB_37 | L29 | -172.5 | -374.5 |
| FSB_DB_36 | K26 | -121.5 | -402.5 |
| FSB_DB_35 | L25 | -70.5 | -374.5 |
| FSB_DB_34 | H29 | -172.5 | -458.5 |
| FSB_DB_33 | F29 | -172.5 | -514.5 |
| FSB_DB_32 | J29 | -172.5 | -430.5 |
| FSB_DB_31 | G30 | -223.5 | -486.5 |
| FSB_DB_30 | M29 | -172.5 | -346.5 |
| FSB_DB_3 | C41 | -551 | -589.9 |
| FSB_DB_29 | K30 | -223.5 | -402.5 |
| FSB_DB_28 | G31 | -274.5 | -486.5 |



Table 54. GMCH Ballout Arranged by Signal Name

| Signal Names | Ball # | X[mils] | Y[mils] |
|--------------|--------|---------|---------|
| FSB_DB_27 | J30 | -223.5 | -430.5 |
| FSB_DB_26 | M30 | -223.5 | -346.5 |
| FSB_DB_25 | M31 | -274.5 | -346.5 |
| FSB_DB_24 | L31 | -274.5 | -374.5 |
| FSB_DB_23 | G33 | -321.5 | -486.5 |
| FSB_DB_22 | L33 | -321.5 | -371.4 |
| FSB_DB_21 | J33 | -321.5 | -430.5 |
| FSB_DB_20 | G37 | -417.5 | -486.5 |
| FSB_DB_2 | D44 | -624 | -553.6 |
| FSB_DB_19 | F37 | -417.5 | -520.5 |
| FSB_DB_18 | H35 | -369.5 | -458.5 |
| FSB_DB_17 | J35 | -369.5 | -430.5 |
| FSB_DB_16 | E37 | -439.8 | -539.1 |
| FSB_DB_15 | B36 | -396 | -608.8 |
| FSB_DB_14 | D37 | -429 | -564.5 |
| FSB_DB_13 | C37 | -429 | -592.1 |
| FSB_DB_12 | D38 | -460.5 | -559.1 |
| FSB_DB_11 | B37 | -429 | -625.6 |
| FSB_DB_10 | A38 | -463.2 | -642.3 |
| FSB_DB_1 | C44 | -605.9 | -579.6 |
| FSB_DB_0 | F44 | -609 | -525.8 |
| FSB_CPURSTB | D27 | -132 | -575.3 |
| FSB_BREQOB | L42 | -560.6 | -363 |
| FSB_BPRIB | H37 | -417.5 | -458.5 |
| FSB_BNRB | J44 | -625.6 | -429 |
| FSB_ADSTBB_1 | T39 | -486.5 | -223.5 |
| FSB_ADSTBB_0 | J40 | -520.5 | -417.5 |
| FSB_ADSB | J42 | -564.5 | -429 |
| FSB_ACCVREF | B23 | 0 | -608.8 |
| FSB_AB_9 | L43 | -592.1 | -363 |
| FSB_AB_8 | L38 | -458.5 | -369.5 |
| FSB_AB_7 | H39 | -497.4 | -463 |
| FSB_AB_6 | F40 | -525.3 | -525.3 |
| FSB_AB_5 | J38 | -458.5 | -417.5 |
| FSB_AB_4 | L37 | -430.5 | -369.5 |
| FSB_AB_35 | AA36 | -402.5 | -70.5 |
| FSB_AB_34 | AA37 | -430.5 | -70.5 |
| FSB_AB_33 | Y38 | -458.5 | -121.5 |
| FSB_AB_32 | Y34 | -346.5 | -121.5 |
| FSB_AB_31 | Y37 | -430.5 | -121.5 |
| FSB_AB_30 | U37 | -430.5 | -172.5 |
| FSB_AB_3 | L36 | -401.3 | -369.5 |
| FSB_AB_29 | AA35 | -374.5 | -70.5 |

Table 54. GMCH Ballout Arranged by Signal Name

| Signal Names | Ball # | X[mils] | Y[mils] |
|-----------------|--------|---------|---------|
| FSB_AB_28 | U35 | -374.5 | -172.5 |
| FSB_AB_27 | Y36 | -402.5 | -121.5 |
| FSB_AB_26 | T34 | -346.5 | -223.5 |
| FSB_AB_25 | U40 | -514.5 | -172.5 |
| FSB_AB_24 | U34 | -346.5 | -172.5 |
| FSB_AB_23 | T37 | -430.5 | -223.5 |
| FSB_AB_22 | U38 | -458.5 | -172.5 |
| FSB_AB_21 | R39 | -486.5 | -274.5 |
| FSB_AB_20 | R37 | -430.5 | -274.5 |
| FSB_AB_19 | R34 | -346.5 | -274.5 |
| FSB_AB_18 | R36 | -402.5 | -274.5 |
| FSB_AB_17 | T36 | -402.5 | -223.5 |
| FSB_AB_16 | R35 | -374.5 | -274.5 |
| FSB_AB_15 | M45 | -642.3 | -330 |
| FSB_AB_14 | N40 | -520.5 | -321.5 |
| FSB_AB_13 | J41 | -539.1 | -439.8 |
| FSB_AB_12 | N37 | -430.5 | -321.5 |
| FSB_AB_11 | N35 | -371.4 | -321.5 |
| FSB_AB_10 | N39 | -486.5 | -321.5 |
| RSVD | AB13 | 318.9 | -19.5 |
| RSVD | AD13 | 318.9 | 19.5 |
| EXP_RCOMPO | Y7 | 486.5 | -121.5 |
| EXP_RBIAS | AG1 | 642.3 | 132 |
| RSVD | AB15 | 254.8 | -36.4 |
| EXP_ICOMPO | Y6 | 514.5 | -121.5 |
| EXP_COMPI | Y8 | 458.5 | -121.5 |
| EXP_CLKP | D9 | 429 | -564.5 |
| EXP_CLKN | E9 | 439.8 | -539.1 |
| NC | AN17 | 172.5 | 318.9 |
| DPL_REFSSCLKINP | G8 | 463 | -497.4 |
| DPL_REFSSCLKINN | G9 | 417.5 | -486.5 |
| DPL_REFCLKINP | E15 | 264 | -547.7 |
| DPL_REFCLKINN | D15 | 264 | -575.3 |
| RSVD | T14 | 290.9 | -223.5 |
| RSVD | T15 | 254.8 | -218.4 |
| RSVD | R14 | 290.5 | -269.3 |
| RSVD | R15 | 254.8 | -254.8 |
| DMI_TXP_3 | AF4 | 560.6 | 99 |
| DMI_TXP_2 | AE2 | 609.3 | 66 |
| DMI_TXP_1 | AD4 | 560.6 | 31 |
| DMI_TXP_0 | AC2 | 608.8 | 0 |
| DMI_TXN_3 | AG4 | 575.3 | 132 |
| DMI_TXN_2 | AF2 | 625.6 | 99 |



Table 54. GMCH Ballout Arranged by Signal Name

| Signal Names | Ball # | X[mils] | Y[mils] |
|---------------------|--------|---------|---------|
| DMI_TXN_1 | AE4 | 559.1 | 64 |
| DMI_TXN_0 | AD2 | 625.6 | 33 |
| DMI_RXP_3 | AF9 | 430.5 | 121.5 |
| DMI_RXP_2 | AE6 | 514.5 | 70.5 |
| DMI_RXP_1 | AE9 | 430.5 | 70.5 |
| DMI_RXP_0 | AD7 | 486.5 | 19.5 |
| DMI_RXN_3 | AF8 | 458.5 | 121.5 |
| DMI_RXN_2 | AE7 | 486.5 | 70.5 |
| DMI_RXN_1 | AE10 | 402.5 | 70.5 |
| DMI_RXN_0 | AD8 | 458.5 | 19.5 |
| DDR3_DRAMRSTB | BC24 | -33 | 592.1 |
| DDR3_DRAM_PW ROK | AR6 | 520.5 | 369.5 |
| DDR3_B_ODT3 | AV40 | -526.9 | 465.5 |
| DDR3_A_WEB | AT44 | -608.8 | 396 |
| DDR3_A_MA0 | BB40 | -523 | 576.3 |
| DDR3_A_CSB1 | AR43 | -592.1 | 363 |
| DDR_VREF | BB44 | -624 | 553.6 |
| DDR_SPU | BC44 | -605.9 | 579.6 |
| DDR_SPD | BC43 | -578.3 | 578.3 |
| DDR_RPU | BA43 | -589.9 | 551 |
| DDR_RPD | AY42 | -576.3 | 523 |
| RSVD | AK33 | -318.9 | 223.5 |
| RSVD | AJ33 | -318.9 | 172.5 |
| DDR_B_WEB | BD36 | -396 | 608.8 |
| DDR_B_RASB | BD35 | -363 | 625.6 |
| DDR_B_ODT_3 | BD42 | -553.6 | 624 |
| DDR_B_ODT_2 | BB38 | -460.5 | 559.1 |
| DDR_B_ODT_1 | BC39 | -495 | 592 |
| DDR_B_ODT_0 | BD37 | -429 | 625.6 |
| DDR_B_MA_9 | BD20 | 99 | 625.6 |
| DDR_B_MA_8 | BB20 | 99 | 560.6 |
| DDR_B_MA_7 | BC20 | 99 | 592.1 |
| DDR_B_MA_6 | BC22 | 33 | 592.1 |
| DDR_B_MA_5 | BD22 | 33 | 625.6 |
| DDR_B_MA_4 | BB22 | 31 | 560.6 |
| DDR_B_MA_3 | BD23 | 0 | 608.8 |
| DDR_B_MA_2 | BB24 | -31 | 560.6 |
| DDR_B_MA_14 | BA19 | 132 | 547.7 |
| DDR_B_MA_13 | BE38 | -463.2 | 642.3 |
| DDR_B_MA_12 | BB19 | 132 | 575.3 |
| DDR_B_MA_11 | BD19 | 132 | 608.8 |
| DDR_B_MA_10 | BC26 | -99 | 592.1 |

Table 54. GMCH Ballout Arranged by Signal Name

| Signal Names | Ball # | X[mils] | Y[mils] |
|--------------|--------|---------|---------|
| DDR_B_MA_1 | BB23 | 0 | 575.3 |
| DDR_B_MA_0 | BD24 | -33 | 625.6 |
| DDR_B_DQSB_7 | AD35 | -374.5 | 19.5 |
| DDR_B_DQSB_6 | AF36 | -402.5 | 121.5 |
| DDR_B_DQSB_5 | AL34 | -346.5 | 274.5 |
| DDR_B_DQSB_4 | AR37 | -430.5 | 369.5 |
| DDR_B_DQSB_3 | AT26 | -121.5 | 402.5 |
| DDR_B_DQSB_2 | AR17 | 172.5 | 374.5 |
| DDR_B_DQSB_1 | AU15 | 274.5 | 430.5 |
| DDR_B_DQSB_0 | AW9 | 417.5 | 486.5 |
| DDR_B_DQS_7 | AB35 | -374.5 | -19.5 |
| DDR_B_DQS_6 | AF37 | -430.5 | 121.5 |
| DDR_B_DQS_5 | AK34 | -346.5 | 223.5 |
| DDR_B_DQS_4 | AR38 | -458.5 | 369.5 |
| DDR_B_DQS_3 | AU26 | -121.5 | 430.5 |
| DDR_B_DQS_2 | AR20 | 121.5 | 374.5 |
| DDR_B_DQS_1 | AT15 | 274.5 | 402.5 |
| DDR_B_DQS_0 | AW8 | 463 | 497.4 |
| DDR_B_DQ_9 | AP15 | 274.5 | 346.5 |
| DDR_B_DQ_8 | AY13 | 321.5 | 520.5 |
| DDR_B_DQ_7 | AY9 | 417.5 | 520.5 |
| DDR_B_DQ_63 | AB38 | -458.5 | -19.5 |
| DDR_B_DQ_62 | AB37 | -430.5 | -19.5 |
| DDR_B_DQ_61 | AE39 | -486.5 | 70.5 |
| DDR_B_DQ_60 | AE36 | -402.5 | 70.5 |
| DDR_B_DQ_6 | AW7 | 505.7 | 505.7 |
| DDR_B_DQ_59 | AA39 | -486.5 | -70.5 |
| DDR_B_DQ_58 | AB40 | -514.5 | -19.5 |
| DDR_B_DQ_57 | AD38 | -458.5 | 19.5 |
| DDR_B_DQ_56 | AD40 | -514.5 | 19.5 |
| DDR_B_DQ_55 | AE35 | -374.5 | 70.5 |
| DDR_B_DQ_54 | AF34 | -346.5 | 121.5 |
| DDR_B_DQ_53 | AJ40 | -514.5 | 172.5 |
| DDR_B_DQ_52 | AK40 | -514.5 | 223.5 |
| DDR_B_DQ_51 | AE37 | -430.5 | 70.5 |
| DDR_B_DQ_50 | AF38 | -458.5 | 121.5 |
| DDR_B_DQ_5 | AU8 | 458.5 | 417.5 |
| DDR_B_DQ_49 | AJ37 | -430.5 | 172.5 |
| DDR_B_DQ_48 | AJ38 | -458.5 | 172.5 |
| DDR_B_DQ_47 | AL39 | -486.5 | 274.5 |
| DDR_B_DQ_46 | AK37 | -430.5 | 223.5 |
| DDR_B_DQ_45 | AN40 | -520.5 | 321.5 |
| DDR_B_DQ_44 | AN39 | -486.5 | 321.5 |

Table 54. GMCH Ballout Arranged by Signal Name

| Signal Names | Ball # | X[mils] | Y[mils] |
|--------------|--------|---------|---------|
| DDR_B_DQ_43 | AJ34 | -346.5 | 172.5 |
| DDR_B_DQ_42 | AK36 | -402.5 | 223.5 |
| DDR_B_DQ_41 | AL36 | -402.5 | 274.5 |
| DDR_B_DQ_40 | AL35 | -374.5 | 274.5 |
| DDR_B_DQ_4 | AU7 | 486.5 | 417.5 |
| DDR_B_DQ_39 | AU41 | -539.1 | 439.8 |
| DDR_B_DQ_38 | AU40 | -520.5 | 417.5 |
| DDR_B_DQ_37 | AW39 | -505.7 | 505.7 |
| DDR_B_DQ_36 | AV39 | -497.4 | 463 |
| DDR_B_DQ_35 | AN37 | -430.5 | 321.5 |
| DDR_B_DQ_34 | AN35 | -371.4 | 321.5 |
| DDR_B_DQ_33 | AU38 | -458.5 | 417.5 |
| DDR_B_DQ_32 | AR36 | -401.3 | 369.5 |
| DDR_B_DQ_31 | AR29 | -172.5 | 374.5 |
| DDR_B_DQ_30 | AP26 | -121.5 | 346.5 |
| DDR_B_DQ_3 | AU11 | 369.5 | 430.5 |
| DDR_B_DQ_29 | AR25 | -70.5 | 374.5 |
| DDR_B_DQ_28 | AW25 | -70.5 | 486.5 |
| DDR_B_DQ_27 | AV29 | -172.5 | 458.5 |
| DDR_B_DQ_26 | AU29 | -172.5 | 430.5 |
| DDR_B_DQ_25 | AV26 | -121.5 | 458.5 |
| DDR_B_DQ_24 | AT25 | -70.5 | 402.5 |
| DDR_B_DQ_23 | AN20 | 121.5 | 318.9 |
| DDR_B_DQ_22 | AT20 | 121.5 | 402.5 |
| DDR_B_DQ_21 | AW16 | 223.5 | 486.5 |
| DDR_B_DQ_20 | AP17 | 172.5 | 346.5 |
| DDR_B_DQ_2 | BA9 | 439.8 | 539.1 |
| DDR_B_DQ_19 | AV20 | 121.5 | 458.5 |
| DDR_B_DQ_18 | AR21 | 70.5 | 374.5 |
| DDR_B_DQ_17 | AV17 | 172.5 | 458.5 |
| DDR_B_DQ_16 | AY17 | 172.5 | 514.5 |
| DDR_B_DQ_15 | AU16 | 223.5 | 430.5 |
| DDR_B_DQ_14 | AP16 | 223.5 | 346.5 |
| DDR_B_DQ_13 | AW13 | 321.5 | 486.5 |
| DDR_B_DQ_12 | AU13 | 321.5 | 430.5 |
| DDR_B_DQ_11 | AT16 | 223.5 | 402.5 |
| DDR_B_DQ_10 | AW15 | 274.5 | 486.5 |
| DDR_B_DQ_1 | AW4 | 560.6 | 492 |
| DDR_B_DQ_0 | AV7 | 497.4 | 463 |
| DDR_B_DM_7 | AD37 | -430.5 | 19.5 |
| DDR_B_DM_6 | AJ35 | -374.5 | 172.5 |
| DDR_B_DM_5 | AL37 | -430.5 | 274.5 |
| DDR_B_DM_4 | AU39 | -486.5 | 417.5 |

Table 54. GMCH Ballout Arranged by Signal Name

| Signal Names | Ball # | X[mils] | Y[mils] |
|--------------|--------|---------|---------|
| DDR_B_DM_3 | AV25 | -70.5 | 458.5 |
| DDR_B_DM_2 | AU17 | 172.5 | 430.5 |
| DDR_B_DM_1 | AR15 | 274.5 | 374.5 |
| DDR_B_DM_0 | AY6 | 525.3 | 525.3 |
| DDR_B_CSB_3 | BD40 | -525.8 | 609 |
| DDR_B_CSB_2 | BB37 | -429 | 564.5 |
| DDR_B_CSB_1 | BD39 | -497.9 | 623.9 |
| DDR_B_CSB_0 | BB35 | -363 | 560.6 |
| DDR_B_CKE_3 | BB18 | 165 | 560.6 |
| DDR_B_CKE_2 | BE17 | 198 | 642.3 |
| DDR_B_CKE_1 | AY20 | 121.5 | 514.5 |
| DDR_B_CKE_0 | BC18 | 165 | 592.1 |
| VSS | AU35 | -369.5 | 430.5 |
| DDR_B_CKB_4 | AP30 | -223.5 | 346.5 |
| DDR_B_CKB_3 | AU31 | -274.5 | 430.5 |
| DDR_B_CKB_2 | AY35 | -369.5 | 520.5 |
| DDR_B_CKB_1 | AW31 | -274.5 | 486.5 |
| DDR_B_CKB_0 | AW33 | -321.5 | 486.5 |
| DDR_B_CK_5 | AW37 | -417.5 | 486.5 |
| DDR_B_CK_4 | AP31 | -274.5 | 346.5 |
| DDR_B_CK_3 | AT31 | -274.5 | 402.5 |
| DDR_B_CK_2 | AW35 | -369.5 | 486.5 |
| DDR_B_CK_1 | AV31 | -274.5 | 458.5 |
| DDR_B_CK_0 | AY33 | -321.5 | 520.5 |
| DDR_B_CASB | BC37 | -429 | 592.1 |
| DDR_B_BS_2 | BD18 | 165 | 625.6 |
| DDR_B_BS_1 | BB26 | -99 | 560.6 |
| DDR_B_BS_0 | BD26 | -99 | 625.6 |
| RSVD | AN30 | -223.5 | 318.9 |
| RSVD | AN29 | -172.5 | 318.9 |
| DDR_A_WEB | AW42 | -560.6 | 492 |
| DDR_A_RASB | AV42 | -559.1 | 460.5 |
| DDR_A_ODT_3 | AL40 | -514.5 | 274.5 |
| DDR_A_ODT_2 | AR44 | -625.6 | 363 |
| DDR_A_ODT_1 | AM44 | -625.6 | 297 |
| DDR_A_ODT_0 | AR42 | -560.6 | 363 |
| DDR_A_MA_9 | BD30 | -231 | 625.6 |
| DDR_A_MA_8 | BD31 | -264 | 608.8 |
| DDR_A_MA_7 | BA31 | -264 | 547.7 |
| DDR_A_MA_6 | AY31 | -274.5 | 514.5 |
| DDR_A_MA_5 | BB31 | -264 | 575.3 |
| DDR_A_MA_4 | BD32 | -297 | 625.6 |
| DDR_A_MA_3 | BC32 | -297 | 592.1 |

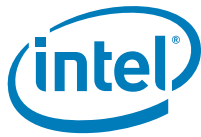

Table 54. GMCH Ballout Arranged by Signal Name

| Signal Names | Ball # | X[mils] | Y[mils] |
|--------------|--------|---------|---------|
| DDR_A_MA_2 | BB32 | -297 | 560.6 |
| DDR_A_MA_14 | BD28 | -165 | 625.6 |
| DDR_A_MA_13 | AM42 | -560.6 | 297 |
| DDR_A_MA_12 | BB30 | -231 | 560.6 |
| DDR_A_MA_11 | BC30 | -231 | 592.1 |
| DDR_A_MA_10 | AW43 | -592 | 495 |
| DDR_A_MA_1 | BC35 | -363 | 592.1 |
| DDR_A_MA_0 | BC41 | -551 | 589.9 |
| DDR_A_DQSB_7 | T43 | -592.1 | -231 |
| DDR_A_DQSB_6 | Y42 | -560.6 | -99 |
| DDR_A_DQSB_5 | AE42 | -559.1 | 64 |
| DDR_A_DQSB_4 | AH42 | -560.6 | 165 |
| DDR_A_DQSB_3 | AT22 | 19.5 | 402.5 |
| DDR_A_DQSB_2 | BB15 | 264 | 575.3 |
| DDR_A_DQS_1 | BB9 | 429 | 564.5 |
| DDR_A_DQSB_0 | BD4 | 553.6 | 624 |
| DDR_A_DQS_7 | T44 | -625.6 | -231 |
| DDR_A_DQS_6 | Y43 | -592.1 | -99 |
| NC | AD42 | -560.6 | 31 |
| DDR_A_DQS_4 | AH43 | -592.1 | 165 |
| DDR_A_DQS_3 | AR22 | 19.5 | 374.5 |
| DDR_A_DQS_2 | BD15 | 264 | 608.8 |
| DDR_A_DQ_14 | BD10 | 396 | 608.8 |
| DDR_A_DQS_0 | BC5 | 551 | 589.9 |
| DDR_A_DM_1 | BD9 | 429 | 625.6 |
| DDR_A_DQ_9 | AY8 | 465.5 | 526.9 |
| DDR_A_DQ_2 | BD7 | 497.9 | 623.9 |
| DDR_A_DQ_63 | R44 | -608.8 | -264 |
| DDR_A_DQ_62 | R41 | -547.7 | -264 |
| DDR_A_DQ_61 | V43 | -592.1 | -165 |
| DDR_A_DQ_60 | V44 | -625.6 | -165 |
| DDR_A_DQ_7 | BD6 | 525.8 | 609 |
| DDR_A_DQ_59 | P44 | -625.6 | -297 |
| DDR_A_DQ_58 | R40 | -514.5 | -274.5 |
| DDR_A_DQ_57 | U45 | -642.3 | -198 |
| DDR_A_DQ_56 | V42 | -560.6 | -165 |
| DDR_A_DQ_55 | Y40 | -514.5 | -121.5 |
| DDR_A_DQ_54 | Y44 | -625.6 | -99 |
| DDR_A_DQ_53 | AB44 | -625.6 | -33 |
| DDR_A_DQ_52 | AB42 | -560.6 | -31 |
| DDR_A_DQ_51 | W41 | -547.7 | -132 |
| DDR_A_DQ_50 | W42 | -575.3 | -132 |
| DDR_A_DQ_5 | BA3 | 589.9 | 551 |

Table 54. GMCH Ballout Arranged by Signal Name

| Signal Names | Ball # | X[mils] | Y[mils] |
|--------------|--------|---------|---------|
| DDR_A_DQ_49 | AA42 | -559.1 | -64 |
| DDR_A_DQ_48 | AB43 | -592.1 | -33 |
| DDR_A_DQ_47 | AC41 | -547.7 | 0 |
| DDR_A_DQ_46 | AD44 | -625.6 | 33 |
| DDR_A_DQ_45 | AF44 | -625.6 | 99 |
| DDR_A_DQ_44 | AF40 | -514.5 | 121.5 |
| DDR_A_DQ_43 | AC42 | -575.3 | 0 |
| DDR_A_DQ_42 | AC44 | -608.8 | 0 |
| DDR_A_DQ_41 | AF42 | -560.6 | 99 |
| DDR_A_DQ_40 | AF43 | -592.1 | 99 |
| DDR_A_DQ_4 | BB2 | 624 | 553.6 |
| DDR_A_DQ_39 | AG41 | -547.7 | 132 |
| DDR_A_DQ_38 | AH44 | -625.6 | 165 |
| DDR_A_DQ_37 | AK44 | -625.6 | 231 |
| DDR_A_DQ_36 | AL42 | -575.3 | 264 |
| DDR_A_DQ_35 | AG44 | -608.8 | 132 |
| DDR_A_DQ_34 | AG42 | -575.3 | 132 |
| DDR_A_DQ_33 | AK43 | -592.1 | 231 |
| DDR_A_DQ_32 | AL41 | -547.7 | 264 |
| DDR_A_DQ_31 | AU24 | -19.5 | 430.5 |
| DDR_A_DQ_30 | AR24 | -19.5 | 374.5 |
| DDR_A_DQ_12 | BC7 | 495 | 592 |
| DDR_A_DQ_29 | AT21 | 70.5 | 402.5 |
| DDR_A_DQ_28 | AU21 | 70.5 | 430.5 |
| DDR_A_DQ_27 | AY24 | -19.5 | 514.5 |
| DDR_A_DQ_26 | AV24 | -19.5 | 458.5 |
| DDR_A_DQ_25 | AY22 | 19.5 | 514.5 |
| DDR_A_DQ_24 | AW21 | 70.5 | 486.5 |
| DDR_A_DQ_23 | BD16 | 231 | 625.6 |
| DDR_A_DQ_22 | BA15 | 264 | 547.7 |
| DDR_A_DQ_16 | BB14 | 297 | 560.6 |
| DDR_A_DQ_21 | BE12 | 330 | 642.3 |
| DDR_A_DQ_3 | BB7 | 492 | 560.6 |
| DDR_A_DQ_19 | BB16 | 231 | 560.6 |
| DDR_A_DQ_18 | BC16 | 231 | 592.1 |
| DDR_A_DM_2 | BD14 | 297 | 625.6 |
| DDR_A_DQ_17 | BC14 | 297 | 592.1 |
| DDR_A_DQ_10 | BD11 | 363 | 625.6 |
| DDR_A_DQ_15 | AY11 | 369.5 | 520.5 |
| DDR_A_DQ_8 | BB8 | 460.5 | 559.1 |
| DDR_A_DQ_13 | BE8 | 463.2 | 642.3 |
| DDR_A_DQ_20 | BC11 | 363 | 592.1 |
| DDR_A_DQ_11 | BB11 | 363 | 560.6 |



Table 54. GMCH Ballout Arranged by Signal Name

| Signal Names | Ball # | X[mils] | Y[mils] |
|---------------|--------|---------|---------|
| DDR_A_DQ_1 | BD3 | 579.6 | 605.9 |
| DDR_A_DQ_0 | BC2 | 605.9 | 579.6 |
| DDR_A_DM_7 | T42 | -560.6 | -231 |
| DDR_A_DM_6 | AA45 | -642.3 | -66 |
| DDR_A_DM_5 | AE45 | -642.3 | 66 |
| DDR_A_DM_4 | AK42 | -560.6 | 231 |
| DDR_A_DM_3 | AV22 | 19.5 | 458.5 |
| VSS | AY15 | 274.5 | 514.5 |
| DDR_A_DQSB_1 | BC9 | 429 | 592.1 |
| DDR_A_DM_0 | BC3 | 578.3 | 578.3 |
| DDR_A_CSB_3 | AM43 | -592.1 | 297 |
| DDR_A_CSB_2 | AU44 | -625.6 | 429 |
| DDR_A_CSB_1 | AR40 | -520.5 | 369.5 |
| DDR_A_CSB_0 | AU43 | -592.1 | 429 |
| DDR_A_CKE_3 | AY26 | -121.5 | 514.5 |
| DDR_A_CKE_2 | BA27 | -132 | 547.7 |
| DDR_A_CKE_1 | BD27 | -132 | 608.8 |
| DDR_A_CKE_0 | BB27 | -132 | 575.3 |
| DDR_A_CKB_5 | AY38 | -465.5 | 526.9 |
| DDR_A_CKB_4 | AR30 | -223.5 | 374.5 |
| DDR_A_CK_3 | AU33 | -321.5 | 430.5 |
| DDR_A_CKB_2 | AV37 | -417.5 | 458.5 |
| DDR_A_CKB_1 | AY29 | -172.5 | 514.5 |
| DDR_A_CKB_0 | BA37 | -439.8 | 539.1 |
| DDR_A_CK_5 | AW38 | -463 | 497.4 |
| DDR_A_CK_4 | AT30 | -223.5 | 402.5 |
| VSS | AV33 | -321.5 | 458.5 |
| DDR_A_CK_2 | AU37 | -418 | 418 |
| DDR_A_CK_1 | AW29 | -172.5 | 486.5 |
| DDR_A_CK_0 | AY37 | -417.5 | 520.5 |
| DDR_A_CASB | AU42 | -564.5 | 429 |
| DDR_A_BS_2 | BC28 | -165 | 592.1 |
| DDR_A_BS_1 | AY44 | -609 | 525.8 |
| DDR_A_BS_0 | AV45 | -642.3 | 463.2 |
| DDPC_CTRLDATA | F11 | 369.5 | -520.5 |
| DDPC_CTRLCLK | J11 | 369.5 | -430.5 |
| VSS | C16 | 231 | -592.1 |
| DAC_IREF | B15 | 264 | -608.8 |
| CRT_VSYNC | C14 | 297 | -592.1 |
| CRT_RED | B18 | 165 | -625.6 |
| CRT_IRTN | F13 | 321.5 | -520.5 |
| CRT_HSYNC | D14 | 297 | -560.6 |
| CRT_GREEN | D18 | 165 | -560.6 |

Table 54. GMCH Ballout Arranged by Signal Name

| Signal Names | Ball # | X[mils] | Y[mils] |
|--------------|--------|---------|---------|
| CRT_DDC_DATA | L15 | 274.5 | -374.5 |
| CRT_DDC_CLK | M15 | 274.5 | -346.5 |
| CRT_BLUE | C18 | 165 | -592.1 |
| HDA_SYNC | AU3 | 592.1 | 429 |
| HDA_SDO | AV1 | 642.3 | 463.2 |
| HDA_SDI | AU2 | 625.6 | 429 |
| HDA_RSTB | AV4 | 559.1 | 460.5 |
| HDA_BCLK | AU4 | 564.5 | 429 |
| — | A1 | | |
| — | A11 | | |
| — | A13 | | |
| — | A14 | | |
| — | A16 | | |
| — | A18 | | |
| — | A2 | | |
| — | A20 | | |
| — | A22 | | |
| — | A24 | | |
| — | A26 | | |
| — | A28 | | |
| — | A30 | | |
| — | A32 | | |
| — | A33 | | |
| — | A35 | | |
| — | A37 | | |
| — | A39 | | |
| — | A4 | | |
| — | A41 | | |
| — | A42 | | |
| — | A5 | | |
| — | A7 | | |
| — | A9 | | |
| — | AA18 | | |
| — | AA28 | | |
| — | AA3 | | |
| — | AA41 | | |
| — | AA43 | | |
| — | AA5 | | |
| — | AB1 | | |
| — | AB18 | | |
| — | AB28 | | |
| — | AB41 | | |
| — | AB45 | | |

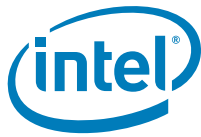

Table 54. GMCH Ballout Arranged by Signal Name

| Signal Names | Ball # | X[mils] | Y[mils] |
|--------------|--------|---------|---------|
| — | AB5 | | |
| — | AC10 | | |
| — | AC11 | | |
| — | AC12 | | |
| — | AC13 | | |
| — | AC14 | | |
| — | AC18 | | |
| — | AC28 | | |
| — | AC3 | | |
| — | AC32 | | |
| — | AC33 | | |
| — | AC34 | | |
| — | AC35 | | |
| — | AC36 | | |
| — | AC37 | | |
| — | AC38 | | |
| — | AC39 | | |
| — | AC40 | | |
| — | AC43 | | |
| — | AC6 | | |
| — | AC7 | | |
| — | AC8 | | |
| — | AC9 | | |
| — | AD1 | | |
| — | AD18 | | |
| — | AD28 | | |
| — | AD41 | | |
| — | AD45 | | |
| — | AD5 | | |
| — | AE18 | | |
| — | AE28 | | |
| — | AE3 | | |
| — | AE41 | | |
| — | AE43 | | |
| — | AE5 | | |
| — | AF1 | | |
| — | AF18 | | |
| — | AF28 | | |
| — | AF41 | | |
| — | AF45 | | |
| — | AF5 | | |
| — | AG10 | | |
| — | AG11 | | |

Table 54. GMCH Ballout Arranged by Signal Name

| Signal Names | Ball # | X[mils] | Y[mils] |
|--------------|--------|---------|---------|
| — | AG12 | | |
| — | AG13 | | |
| — | AG14 | | |
| — | AG18 | | |
| — | AG28 | | |
| — | AG3 | | |
| — | AG32 | | |
| — | AG33 | | |
| — | AG34 | | |
| — | AG35 | | |
| — | AG36 | | |
| — | AG37 | | |
| — | AG38 | | |
| — | AG39 | | |
| — | AG40 | | |
| — | AG43 | | |
| — | AG6 | | |
| — | AG7 | | |
| — | AG8 | | |
| — | AG9 | | |
| — | AH1 | | |
| — | AH10 | | |
| — | AH11 | | |
| — | AH12 | | |
| — | AH13 | | |
| — | AH14 | | |
| — | AH15 | | |
| — | AH16 | | |
| — | AH17 | | |
| — | AH18 | | |
| — | AH19 | | |
| — | AH20 | | |
| — | AH21 | | |
| — | AH22 | | |
| — | AH23 | | |
| — | AH24 | | |
| — | AH25 | | |
| — | AH26 | | |
| — | AH27 | | |
| — | AH28 | | |
| — | AH29 | | |
| — | AH30 | | |
| — | AH31 | | |



Table 54. GMCH Ballout Arranged by Signal Name

| Signal Names | Ball # | X[mils] | Y[mils] |
|--------------|--------|---------|---------|
| — | AH32 | | |
| — | AH33 | | |
| — | AH34 | | |
| — | AH35 | | |
| — | AH36 | | |
| — | AH37 | | |
| — | AH38 | | |
| — | AH39 | | |
| — | AH40 | | |
| — | AH41 | | |
| — | AH45 | | |
| — | AH5 | | |
| — | AH6 | | |
| — | AH7 | | |
| — | AH8 | | |
| — | AH9 | | |
| — | AJ18 | | |
| — | AJ28 | | |
| — | AJ3 | | |
| — | AJ4 | | |
| — | AJ41 | | |
| — | AJ42 | | |
| — | AJ43 | | |
| — | AJ5 | | |
| — | AK1 | | |
| — | AK18 | | |
| — | AK28 | | |
| — | AK41 | | |
| — | AK45 | | |
| — | AK5 | | |
| — | AL13 | | |
| — | AL18 | | |
| — | AL28 | | |
| — | AL3 | | |
| — | AL33 | | |
| — | AL43 | | |
| — | AM1 | | |
| — | AM10 | | |
| — | AM11 | | |
| — | AM12 | | |
| — | AM13 | | |
| — | AM14 | | |
| — | AM18 | | |

Table 54. GMCH Ballout Arranged by Signal Name

| Signal Names | Ball # | X[mils] | Y[mils] |
|--------------|--------|---------|---------|
| — | AM19 | | |
| — | AM23 | | |
| — | AM27 | | |
| — | AM28 | | |
| — | AM32 | | |
| — | AM33 | | |
| — | AM34 | | |
| — | AM35 | | |
| — | AM36 | | |
| — | AM37 | | |
| — | AM38 | | |
| — | AM39 | | |
| — | AM40 | | |
| — | AM41 | | |
| — | AM45 | | |
| — | AM5 | | |
| — | AM6 | | |
| — | AM7 | | |
| — | AM8 | | |
| — | AM9 | | |
| — | AN1 | | |
| — | AN12 | | |
| — | AN14 | | |
| — | AN15 | | |
| — | AN18 | | |
| — | AN19 | | |
| — | AN2 | | |
| — | AN23 | | |
| — | AN27 | | |
| — | AN28 | | |
| — | AN3 | | |
| — | AN31 | | |
| — | AN32 | | |
| — | AN34 | | |
| — | AN4 | | |
| — | AN41 | | |
| — | AN42 | | |
| — | AN43 | | |
| — | AN44 | | |
| — | AN45 | | |
| — | AN5 | | |
| — | AP10 | | |
| — | AP11 | | |



Table 54. GMCH Ballout Arranged by Signal Name

| Signal Names | Ball # | X[mils] | Y[mils] |
|--------------|--------|---------|---------|
| — | AP12 | | |
| — | AP13 | | |
| — | AP14 | | |
| — | AP18 | | |
| — | AP19 | | |
| — | AP23 | | |
| — | AP27 | | |
| — | AP28 | | |
| — | AP3 | | |
| — | AP32 | | |
| — | AP33 | | |
| — | AP34 | | |
| — | AP35 | | |
| — | AP36 | | |
| — | AP37 | | |
| — | AP38 | | |
| — | AP39 | | |
| — | AP4 | | |
| — | AP40 | | |
| — | AP41 | | |
| — | AP42 | | |
| — | AP43 | | |
| — | AP5 | | |
| — | AP6 | | |
| — | AP7 | | |
| — | AP8 | | |
| — | AP9 | | |
| — | AR1 | | |
| — | AR12 | | |
| — | AR14 | | |
| — | AR18 | | |
| — | AR19 | | |
| — | AR23 | | |
| — | AR27 | | |
| — | AR28 | | |
| — | AR32 | | |
| — | AR34 | | |
| — | AR41 | | |
| — | AR45 | | |
| — | AR5 | | |
| — | AT10 | | |
| — | AT12 | | |
| — | AT14 | | |

Table 54. GMCH Ballout Arranged by Signal Name

| Signal Names | Ball # | X[mils] | Y[mils] |
|--------------|--------|---------|---------|
| — | AT18 | | |
| — | AT19 | | |
| — | AT23 | | |
| — | AT27 | | |
| — | AT28 | | |
| — | AT3 | | |
| — | AT32 | | |
| — | AT34 | | |
| — | AT36 | | |
| — | AT37 | | |
| — | AT38 | | |
| — | AT39 | | |
| — | AT4 | | |
| — | AT40 | | |
| — | AT41 | | |
| — | AT42 | | |
| — | AT43 | | |
| — | AT5 | | |
| — | AT6 | | |
| — | AT7 | | |
| — | AT8 | | |
| — | AT9 | | |
| — | AU1 | | |
| — | AU10 | | |
| — | AU12 | | |
| — | AU14 | | |
| — | AU18 | | |
| — | AU19 | | |
| — | AU23 | | |
| — | AU27 | | |
| — | AU28 | | |
| — | AU32 | | |
| — | AU34 | | |
| — | AU36 | | |
| — | AU45 | | |
| — | AV10 | | |
| — | AV12 | | |
| — | AV14 | | |
| — | AV18 | | |
| — | AV19 | | |
| — | AV23 | | |
| — | AV27 | | |
| — | AV28 | | |



Table 54. GMCH Ballout Arranged by Signal Name

| Signal Names | Ball # | X[mils] | Y[mils] |
|--------------|--------|---------|---------|
| — | AV3 | | |
| — | AV32 | | |
| — | AV34 | | |
| — | AV36 | | |
| — | AV41 | | |
| — | AV43 | | |
| — | AV5 | | |
| — | AW1 | | |
| — | AW10 | | |
| — | AW12 | | |
| — | AW14 | | |
| — | AW18 | | |
| — | AW19 | | |
| — | AW23 | | |
| — | AW27 | | |
| — | AW28 | | |
| — | AW32 | | |
| — | AW34 | | |
| — | AW36 | | |
| — | AW40 | | |
| — | AW41 | | |
| — | AW45 | | |
| — | AW5 | | |
| — | AW6 | | |
| — | AY10 | | |
| — | AY12 | | |
| — | AY14 | | |
| — | AY18 | | |
| — | AY19 | | |
| — | AY23 | | |
| — | AY27 | | |
| — | AY28 | | |
| — | AY3 | | |
| — | AY32 | | |
| — | AY34 | | |
| — | AY36 | | |
| — | AY39 | | |
| — | AY41 | | |
| — | AY43 | | |
| — | AY5 | | |
| — | AY7 | | |
| — | B1 | | |
| — | B13 | | |

Table 54. GMCH Ballout Arranged by Signal Name

| Signal Names | Ball # | X[mils] | Y[mils] |
|--------------|--------|---------|---------|
| — | B33 | | |
| — | B41 | | |
| — | B5 | | |
| — | BA1 | | |
| — | BA10 | | |
| — | BA11 | | |
| — | BA12 | | |
| — | BA13 | | |
| — | BA14 | | |
| — | BA16 | | |
| — | BA17 | | |
| — | BA18 | | |
| — | BA2 | | |
| — | BA20 | | |
| — | BA21 | | |
| — | BA22 | | |
| — | BA24 | | |
| — | BA25 | | |
| — | BA26 | | |
| — | BA28 | | |
| — | BA29 | | |
| — | BA30 | | |
| — | BA32 | | |
| — | BA33 | | |
| — | BA34 | | |
| — | BA35 | | |
| — | BA36 | | |
| — | BA38 | | |
| — | BA39 | | |
| — | BA4 | | |
| — | BA40 | | |
| — | BA42 | | |
| — | BA44 | | |
| — | BA45 | | |
| — | BA6 | | |
| — | BA7 | | |
| — | BA8 | | |
| — | BB1 | | |
| — | BB10 | | |
| — | BB12 | | |
| — | BB13 | | |
| — | BB17 | | |
| — | BB29 | | |



Table 54. GMCH Ballout Arranged by Signal Name

| Signal Names | Ball # | X[mils] | Y[mils] |
|--------------|--------|---------|---------|
| — | BB3 | | |
| — | BB33 | | |
| — | BB34 | | |
| — | BB36 | | |
| — | BB4 | | |
| — | BB41 | | |
| — | BB42 | | |
| — | BB43 | | |
| — | BB45 | | |
| — | BB5 | | |
| — | BC10 | | |
| — | BC12 | | |
| — | BC13 | | |
| — | BC15 | | |
| — | BC17 | | |
| — | BC19 | | |
| — | BC21 | | |
| — | BC23 | | |
| — | BC25 | | |
| — | BC27 | | |
| — | BC29 | | |
| — | BC31 | | |
| — | BC33 | | |
| — | BC34 | | |
| — | BC36 | | |
| — | BC38 | | |
| — | BC4 | | |
| — | BC40 | | |
| — | BC42 | | |
| — | BC6 | | |
| — | BC8 | | |
| — | BD13 | | |
| — | BD33 | | |
| — | BD41 | | |
| — | BD5 | | |
| — | BE11 | | |
| — | BE13 | | |
| — | BE14 | | |
| — | BE16 | | |
| — | BE18 | | |
| — | BE20 | | |
| — | BE22 | | |
| — | BE24 | | |

Table 54. GMCH Ballout Arranged by Signal Name

| Signal Names | Ball # | X[mils] | Y[mils] |
|--------------|--------|---------|---------|
| — | BE26 | | |
| — | BE28 | | |
| — | BE30 | | |
| — | BE32 | | |
| — | BE33 | | |
| — | BE35 | | |
| — | BE37 | | |
| — | BE39 | | |
| — | BE4 | | |
| — | BE41 | | |
| — | BE42 | | |
| — | BE5 | | |
| — | BE7 | | |
| — | BE9 | | |
| — | C10 | | |
| — | C12 | | |
| — | C13 | | |
| — | C15 | | |
| — | C17 | | |
| — | C19 | | |
| — | C21 | | |
| — | C23 | | |
| — | C25 | | |
| — | C27 | | |
| — | C29 | | |
| — | C31 | | |
| — | C33 | | |
| — | C34 | | |
| — | C36 | | |
| — | C38 | | |
| — | C4 | | |
| — | C40 | | |
| — | C42 | | |
| — | C6 | | |
| — | C8 | | |
| — | D1 | | |
| — | D10 | | |
| — | D12 | | |
| — | D13 | | |
| — | D17 | | |
| — | D29 | | |
| — | D3 | | |
| — | D33 | | |



Table 54. GMCH Ballout Arranged by Signal Name

| Signal Names | Ball # | X[mils] | Y[mils] |
|--------------|--------|---------|---------|
| — | D34 | | |
| — | D36 | | |
| — | D4 | | |
| — | D41 | | |
| — | D42 | | |
| — | D43 | | |
| — | D45 | | |
| — | D5 | | |
| — | E1 | | |
| — | E10 | | |
| — | E11 | | |
| — | E12 | | |
| — | E13 | | |
| — | E14 | | |
| — | E16 | | |
| — | E17 | | |
| — | E18 | | |
| — | E2 | | |
| — | E20 | | |
| — | E21 | | |
| — | E22 | | |
| — | E24 | | |
| — | E25 | | |
| — | E26 | | |
| — | E28 | | |
| — | E29 | | |
| — | E30 | | |
| — | E32 | | |
| — | E33 | | |
| — | E34 | | |
| — | E35 | | |
| — | E36 | | |
| — | E38 | | |
| — | E39 | | |
| — | E4 | | |
| — | E40 | | |
| — | E42 | | |
| — | E44 | | |
| — | E45 | | |
| — | E6 | | |
| — | E7 | | |
| — | E8 | | |
| — | F10 | | |

Table 54. GMCH Ballout Arranged by Signal Name

| Signal Names | Ball # | X[mils] | Y[mils] |
|--------------|--------|---------|---------|
| — | F12 | | |
| — | F14 | | |
| — | F18 | | |
| — | F19 | | |
| — | F23 | | |
| — | F27 | | |
| — | F28 | | |
| — | F3 | | |
| — | F32 | | |
| — | F34 | | |
| — | F36 | | |
| — | F39 | | |
| — | F41 | | |
| — | F43 | | |
| — | F5 | | |
| — | F7 | | |
| — | G1 | | |
| — | G10 | | |
| — | G12 | | |
| — | G14 | | |
| — | G18 | | |
| — | G19 | | |
| — | G23 | | |
| — | G27 | | |
| — | G28 | | |
| — | G32 | | |
| — | G34 | | |
| — | G36 | | |
| — | G40 | | |
| — | G41 | | |
| — | G45 | | |
| — | G5 | | |
| — | G6 | | |
| — | H10 | | |
| — | H12 | | |
| — | H14 | | |
| — | H18 | | |
| — | H19 | | |
| — | H23 | | |
| — | H27 | | |
| — | H28 | | |
| — | H3 | | |
| — | H32 | | |

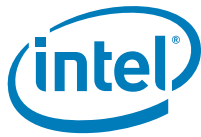

Table 54. GMCH Ballout Arranged by Signal Name

| Signal Names | Ball # | X[mils] | Y[mils] |
|--------------|--------|---------|---------|
| — | H34 | | |
| — | H36 | | |
| — | H41 | | |
| — | H43 | | |
| — | H5 | | |
| — | J1 | | |
| — | J10 | | |
| — | J12 | | |
| — | J14 | | |
| — | J18 | | |
| — | J19 | | |
| — | J23 | | |
| — | J27 | | |
| — | J28 | | |
| — | J32 | | |
| — | J34 | | |
| — | J36 | | |
| — | J45 | | |
| — | K10 | | |
| — | K12 | | |
| — | K14 | | |
| — | K18 | | |
| — | K19 | | |
| — | K23 | | |
| — | K27 | | |
| — | K28 | | |
| — | K3 | | |
| — | K32 | | |
| — | K34 | | |
| — | K36 | | |
| — | K37 | | |
| — | K38 | | |
| — | K39 | | |
| — | K4 | | |
| — | K40 | | |
| — | K41 | | |
| — | K42 | | |
| — | K43 | | |
| — | K5 | | |
| — | K6 | | |
| — | K7 | | |
| — | K8 | | |
| — | K9 | | |

Table 54. GMCH Ballout Arranged by Signal Name

| Signal Names | Ball # | X[mils] | Y[mils] |
|--------------|--------|---------|---------|
| — | L1 | | |
| — | L12 | | |
| — | L14 | | |
| — | L18 | | |
| — | L19 | | |
| — | L23 | | |
| — | L27 | | |
| — | L28 | | |
| — | L32 | | |
| — | L34 | | |
| — | L41 | | |
| — | L45 | | |
| — | L5 | | |
| — | M10 | | |
| — | M11 | | |
| — | M12 | | |
| — | M13 | | |
| — | M14 | | |
| — | M18 | | |
| — | M19 | | |
| — | M23 | | |
| — | M27 | | |
| — | M28 | | |
| — | M3 | | |
| — | M32 | | |
| — | M33 | | |
| — | M34 | | |
| — | M35 | | |
| — | M36 | | |
| — | M37 | | |
| — | M38 | | |
| — | M39 | | |
| — | M4 | | |
| — | M40 | | |
| — | M41 | | |
| — | M42 | | |
| — | M43 | | |
| — | M5 | | |
| — | M6 | | |
| — | M7 | | |
| — | M8 | | |
| — | M9 | | |
| — | N1 | | |



Table 54. GMCH Ballout Arranged by Signal Name

| Signal Names | Ball # | X[mils] | Y[mils] |
|--------------|--------|---------|---------|
| — | N12 | | |
| — | N14 | | |
| — | N15 | | |
| — | N18 | | |
| — | N19 | | |
| — | N2 | | |
| — | N23 | | |
| — | N27 | | |
| — | N28 | | |
| — | N3 | | |
| — | N31 | | |
| — | N32 | | |
| — | N34 | | |
| — | N4 | | |
| — | N41 | | |
| — | N42 | | |
| — | N43 | | |
| — | N44 | | |
| — | N45 | | |
| — | N5 | | |
| — | P1 | | |
| — | P10 | | |
| — | P11 | | |
| — | P12 | | |
| — | P13 | | |
| — | P14 | | |
| — | P18 | | |
| — | P19 | | |
| — | P23 | | |
| — | P27 | | |
| — | P28 | | |
| — | P32 | | |
| — | P33 | | |
| — | P34 | | |
| — | P35 | | |
| — | P36 | | |
| — | P37 | | |
| — | P38 | | |
| — | P39 | | |
| — | P40 | | |
| — | P41 | | |
| — | P45 | | |
| — | P5 | | |

Table 54. GMCH Ballout Arranged by Signal Name

| Signal Names | Ball # | X[mils] | Y[mils] |
|--------------|--------|---------|---------|
| — | P6 | | |
| — | P7 | | |
| — | P8 | | |
| — | P9 | | |
| — | R13 | | |
| — | R18 | | |
| — | R28 | | |
| — | R3 | | |
| — | R33 | | |
| — | R43 | | |
| — | T1 | | |
| — | T18 | | |
| — | T28 | | |
| — | T41 | | |
| — | T45 | | |
| — | T5 | | |
| — | U18 | | |
| — | U28 | | |
| — | U3 | | |
| — | U4 | | |
| — | U41 | | |
| — | U42 | | |
| — | U43 | | |
| — | U5 | | |
| — | V1 | | |
| — | V10 | | |
| — | V11 | | |
| — | V12 | | |
| — | V13 | | |
| — | V14 | | |
| — | V15 | | |
| — | V16 | | |
| — | V17 | | |
| — | V18 | | |
| — | V19 | | |
| — | V20 | | |
| — | V21 | | |
| — | V22 | | |
| — | V23 | | |
| — | V24 | | |
| — | V25 | | |
| — | V26 | | |
| — | V27 | | |



Table 54. GMCH Ballout Arranged by Signal Name

| Signal Names | Ball # | X[mils] | Y[mils] |
|--------------|--------|---------|---------|
| — | V28 | | |
| — | V29 | | |
| — | V30 | | |
| — | V31 | | |
| — | V32 | | |
| — | V33 | | |
| — | V34 | | |
| — | V35 | | |
| — | V36 | | |
| — | V37 | | |
| — | V38 | | |
| — | V39 | | |
| — | V40 | | |
| — | V41 | | |
| — | V45 | | |
| — | V5 | | |
| — | V6 | | |
| — | V7 | | |
| — | V8 | | |
| — | V9 | | |
| — | W10 | | |
| — | W11 | | |
| — | W12 | | |
| — | W13 | | |
| — | W14 | | |
| — | W18 | | |
| — | W28 | | |
| — | W3 | | |
| — | W32 | | |
| — | W33 | | |
| — | W34 | | |
| — | W35 | | |
| — | W36 | | |
| — | W37 | | |
| — | W38 | | |
| — | W39 | | |
| — | W40 | | |
| — | W43 | | |
| — | W6 | | |
| — | W7 | | |
| — | W8 | | |
| — | W9 | | |
| — | Y1 | | |

Table 54. GMCH Ballout Arranged by Signal Name

| Signal Names | Ball # | X[mils] | Y[mils] |
|--------------|--------|---------|---------|
| — | Y18 | | |
| — | Y28 | | |
| — | Y41 | | |
| — | Y45 | | |
| — | Y5 | | |



15.2 Package Specifications

The (G)MCH is available in a 34 mm [1.34 in] x 34 mm [1.34 in] Flip Chip Ball Grid Array (FC-BGA) package with 1254 solder balls (see Figure 21). Refer to the *Intel® 4 Series Chipset Family Thermal and Mechanical Design Guide* for details.

Figure 21. (G)MCH Package Drawing

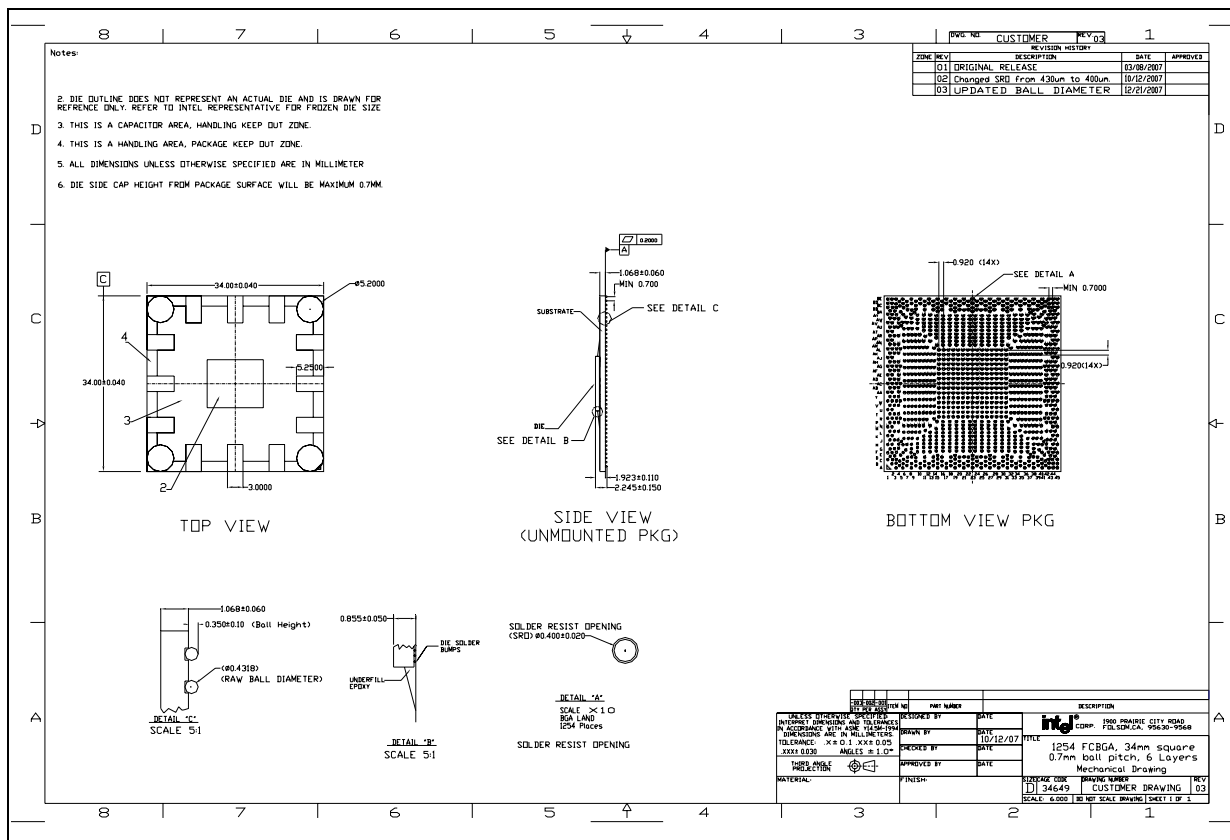

§ §





16 Testability

In the (G)MCH, testability for Automated Test Equipment (ATE) board level testing has been implemented as both JTAG boundary scan and XOR chains.

16.1 JTAG Boundary Scan

The (G)MCH adds Boundary Scan ability compatible with the IEEE 1149.1-2001 Standard (Test Access Port and Boundary-Scan Architecture) specification. Refer to the above mentioned specification for functionality. See [Figure 22](#) for test mode entry.

Figure 22. JTAG Boundary Scan Test Mode Initialization Cycles

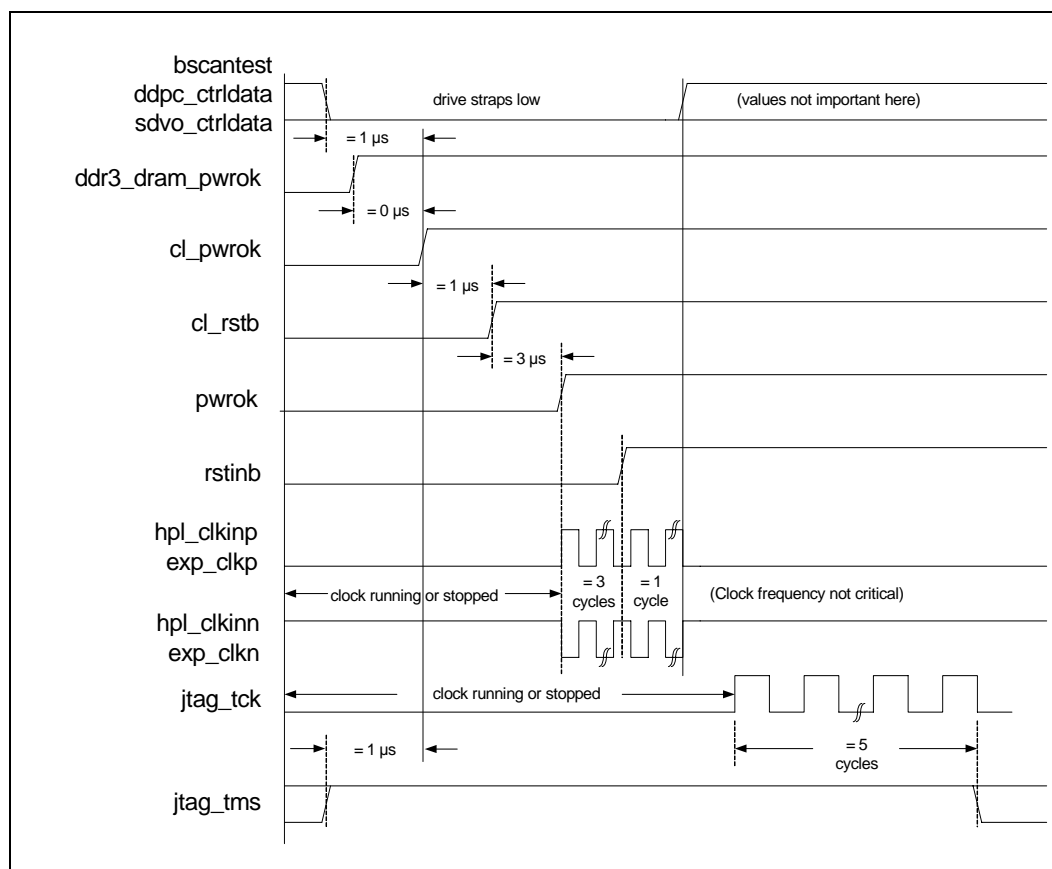

The BSCANTEST pin serves as a boundary-scan test strap. Assertion of this strap (low) is required to disable glitch-masking logic; otherwise, boundary-scan control signals to device pin are blocked.

The DDR3_DRAM_PWROK pin must be high for the ddr3_dramrstb pin boundary-scan data to become valid. Note that this signal is only used on platforms where DDR3 is enabled. On DDR2 platforms, if DDR3_DRAM_PWROK is held low, then the boundary-scan data on the ddr3_dramrstb pin will be invalid.

The CL_PWROK pin provides hardware reset to the TAP, so it must be driven low at power up to ensure clean reset to the TAP. This pin must be driven high to indicate that power is valid, which also allows the TAP to come out of reset.

CL_RSTB must be high for the specified time, for fuses to be loaded and valid before PWROK is asserted.

The PWROK pin must be driven high in order to indicate that power is valid. It also latches the BSCANTEST strap.

The RSTINB pin must be initially active (low) then de-asserted (high) so that the I/O buffers will operate correctly.

Clocking of the HPL_CLKINN/P and EXP_CLKN/P pins is required to initialize internal registers including those that set default buffer compensation values. Clock frequency is not critical due to PLL bypass mode forced when bscantest strap is asserted.

The JTAG_TMS pin should be held high before asserting MEPWROK (CL_PWROK), and held high for at least 5 JTAG_TCK cycles to ensure that the TAP exits the Test-Logic-Reset state at the expected time once TMS goes low. Note that JTAG_TMS has an internal pullup.

16.1.1 TAP Instructions and Opcodes

The TAP controller supports the JTAG instructions as listed in [Table 55](#). The instruction register length is 4 bits.

Table 55. Supported TAP Instructions

| Opcode (binary) | Instruction | Selected Test Data Register | TDR Length |
|-----------------|-----------------------------|------------------------------------------------------|------------|
| 0000b | EXTEST | Boundary-scan | 485 |
| 0001b | SAMPLE/ PRELOAD (SAMPRE) | Boundary-scan | 485 |
| 0011b | IDCODE | Device Identification (value: 0x04105013) | 32 |
| 0100b | CLAMP | Bypass | 1 |
| 0101b | EXTEST_TOGGLE | Boundary-scan | 485 |
| 0110b | HIGHZ | Bypass | 1 |
| 1111b | BYPASS | Bypass | 1 |
| others | Reserved | | |

16.1.2 TAP interface and timings.

The (G)MCH uses 4 dedicated pins to access the Test Access Port (TAP), and the port timings are shown in [Figure 23](#).



Table 56. JTAG Pins

| Pin | Direction | Description |
|----------|------------------------|---------------------------------------------------------------------------------------------------------------------------------------------------------------------------------------------------------------------------------------------------------------------|
| JTAG_TCK | Input | Test clock pin for JTAG TAP Controller and test logic |
| JTAG_TMS | Input with weak pullup | JTAG Test Mode Select pin. Sampled by the TAP on the Rising edge of TCK to control the operation of the TAP state machine. It is recommended that TMS is held high when (CL_PWROK) is driven from low-to-high, to ensure deterministic operation of the test logic. |
| JTAG_TDI | Input with weak pullup | JTAG Test Data Input pin, sampled on the Rising edge of TCK to provide serial test instructions and data. |
| JTAG_TDO | Output | JTAG Test Data Output pin. In inactive drive state except when instructions or data are being shifted. TDO changes on the falling edge of TCK. During shifting, TDO drives actively high and low. |

Figure 23. JTAG Test Mode Initialization Cycles

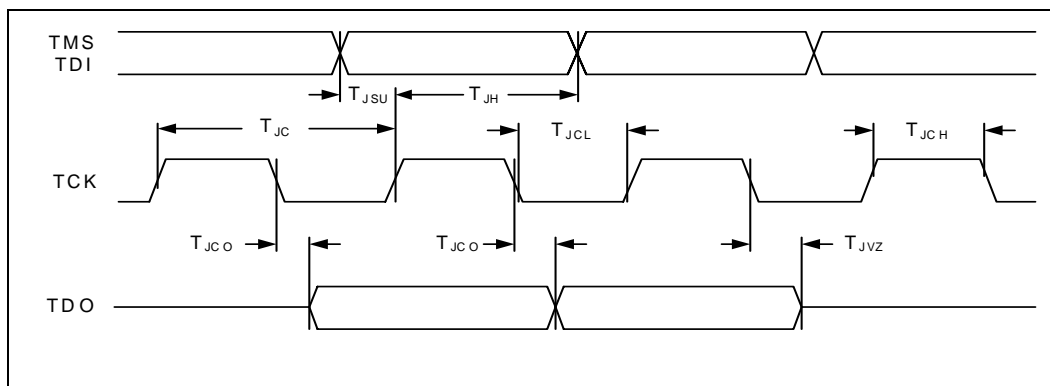

Table 57. JTAG Signal Timings

| Symbol | Parameter | Min | Max | Unit | Notes |
|------------------|------------------------------------------|-----------------------|-----|------|--------|
| T _{JC} | JTAG TCK clock period | 25 | — | ns | 40 MHz |
| T _{JCL} | JTAG TCK clock low time | 0.4 * T _{JC} | — | ns | |
| T _{JCH} | JTAG TCK clock high time | 0.4 * T _{JC} | — | ns | |
| T _{JSU} | Setup of TMS and TDI before TCK rising | 11 | — | ns | |
| T _{JH} | TMS and TDI hold after TCK rising | 5 | — | ns | |
| T _{JCO} | TCK falling to TDO output valid | — | 7 | ns | |
| T _{JVZ} | TCK falling to TDO output high-impedance | — | 9 | ns | |

16.2 XOR Test Mode Initialization

An XOR-tree is a chain of XOR gates each with one input pin connected to it, which allows for pad to ball to trace connection testing.

The XOR testing methodology is to boot the part using straps to enter XOR mode (A description of the boot process follows). Once in XOR mode, all of the pins of an XOR chain are driven to logic 1. This action will force the output of that XOR chain to either a 1 if the number of the pins making up the chain is even or a 0 if the number of the pins making up the chain is odd.

Once a valid output is detected on the XOR chain output, a walking 0 pattern is moved from one end of the chain to the other. Every time the walking 0 is applied to a pin on the chain, the output will toggle. If the output does not toggle, there is a disconnect somewhere between die, package, and board and the system can be considered a failure.

Figure 24. XOR Test Mode Initialization Cycles

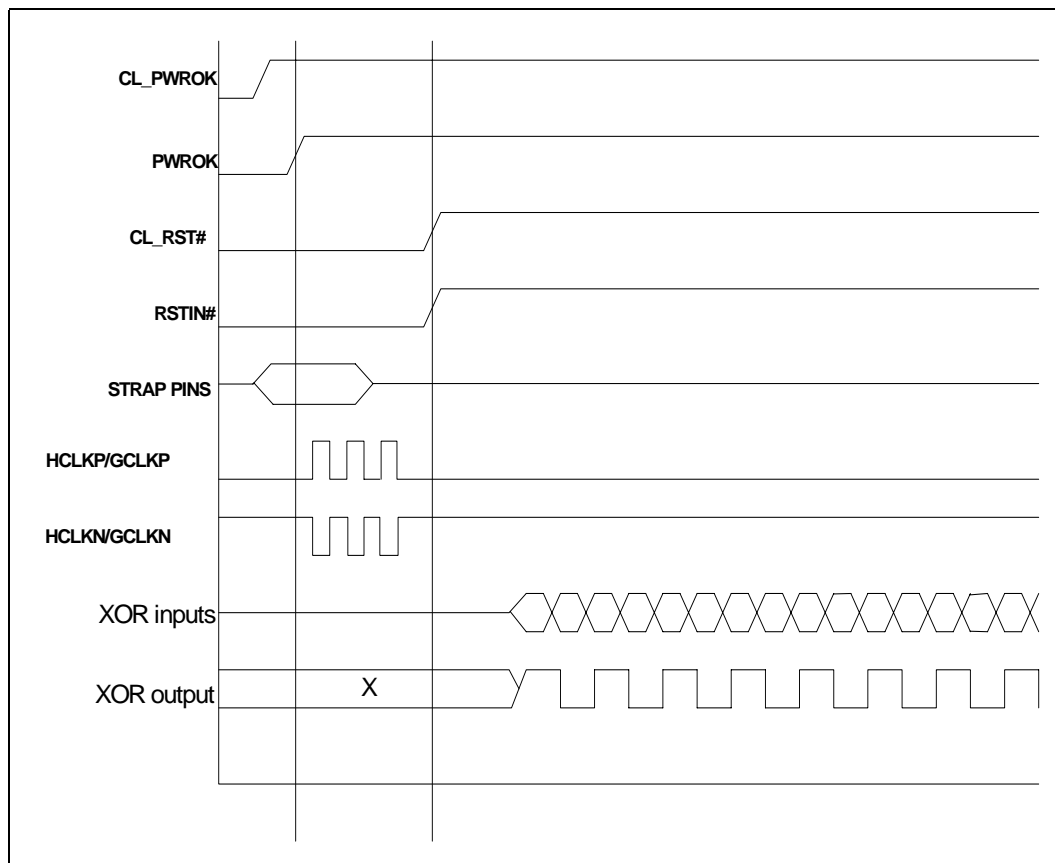
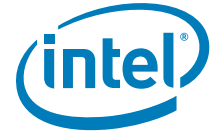

Figure 24 shows the wave forms to be able to boot the (G)MCH into XOR mode. The straps that need to be controlled during this boot process are BSEL[2:0], SDVO_CTRLDATA, EXP_EN, EXP_SLR, and XORTEST.

All strap values must be driven before PWROK asserts. BSEL0 must be a 1. BSEL[2:1] need to be defined values, but logic value in any order will work. XORTEST must be driven to 0.



If sDVO is present in the design, SDVO_CTRLDATA must be pulled to logic 1. Depending on if Static Lane Reversal is used and if the sDVO/PCIe Coexistence is selected, EXP_SLR and EXP_EN must be pulled in a valid manner.

16.2.1 XOR Chain Definition

For the (G)MCH XOR chain definitions, contact your Intel field representative.

§ §

