

NCP1030, NCP1031

Low Power PWM Controller with On-Chip Power Switch and Startup Circuits for 48 V Telecom Systems

The NCP1030 and NCP1031 are a family of miniature high-voltage monolithic switching regulators with on-chip Power Switch and Startup Circuits. The NCP103x family incorporates in a single IC all the active power, control logic and protection circuitry required to implement, with minimal external components, several switching regulator applications, such as a secondary side bias supply or a low power dc-dc converter. This controller family is ideally suited for 48 V telecom, 42 V automotive and 12 V input applications. The NCP103x can be configured in any single-ended topology such as forward or flyback. The NCP1030 is targeted for applications requiring up to 3 W, and the NCP1031 is targeted for applications requiring up to 6 W.

The internal error amplifier allows the NCP103x family to be easily configured for secondary or primary side regulation operation in isolated and non-isolated configurations. The fixed frequency oscillator is optimized for operation up to 1 MHz and is capable of external frequency synchronization, providing additional design flexibility. In addition, the NCP103x incorporates individual line undervoltage and overvoltage detectors, cycle by cycle current limit and thermal shutdown to protect the controller under fault conditions. The preset current limit thresholds eliminate the need for external sensing components.

Features

- On Chip High 200 V Power Switch Circuit and Startup Circuit
- Internal Startup Regulator with Auxiliary Winding Override
- Operation up to 1 MHz
- External Frequency Synchronization Capability
- Frequency Fold-down Under Fault Conditions
- Trimmed $\pm 2\%$ Internal Reference
- Line Undervoltage and Overvoltage Detectors
- Cycle by Cycle Current Limit Using SENSEFET™
- Active LEB Circuit
- Overtemperature Protection
- Internal Error Amplifier

Typical Applications

- Secondary Side Bias Supply for Isolated dc-dc Converters
- Stand Alone Low Power dc-dc Converter
- Low Power Bias Supply
- Low Power Boost Converter



ON Semiconductor®

<http://onsemi.com>

MARKING DIAGRAMS

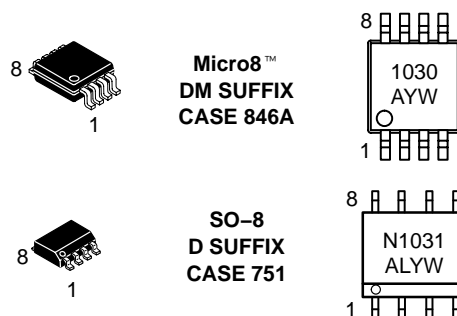

1030/N1031 = Specific Device Code
A = Assembly Location
L = Wafer Lot
Y = Year
W = Work Week

PIN CONNECTIONS

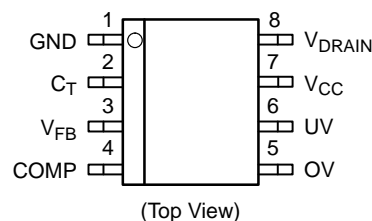

ORDERING INFORMATION

Device	Package	Shipping†
NCP1030DMR2	Micro8™	4000/Tape & Reel
NCP1031DR2	SO-8	2500/Tape & Reel

†For information on tape and reel specifications, including part orientation and tape sizes, please refer to our Tape and Reel Packaging Specification Brochure, BRD8011/D.

NCP1030, NCP1031

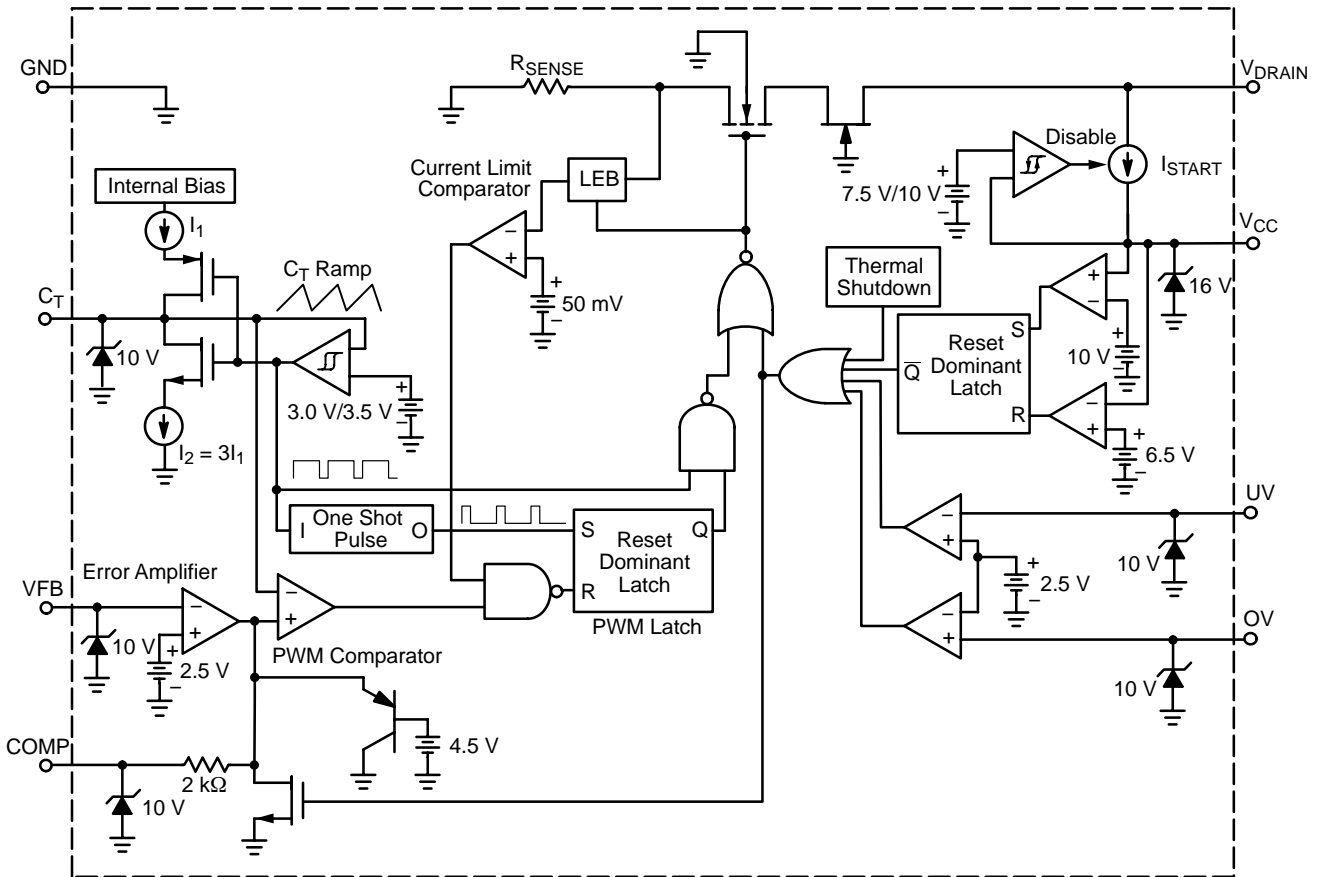
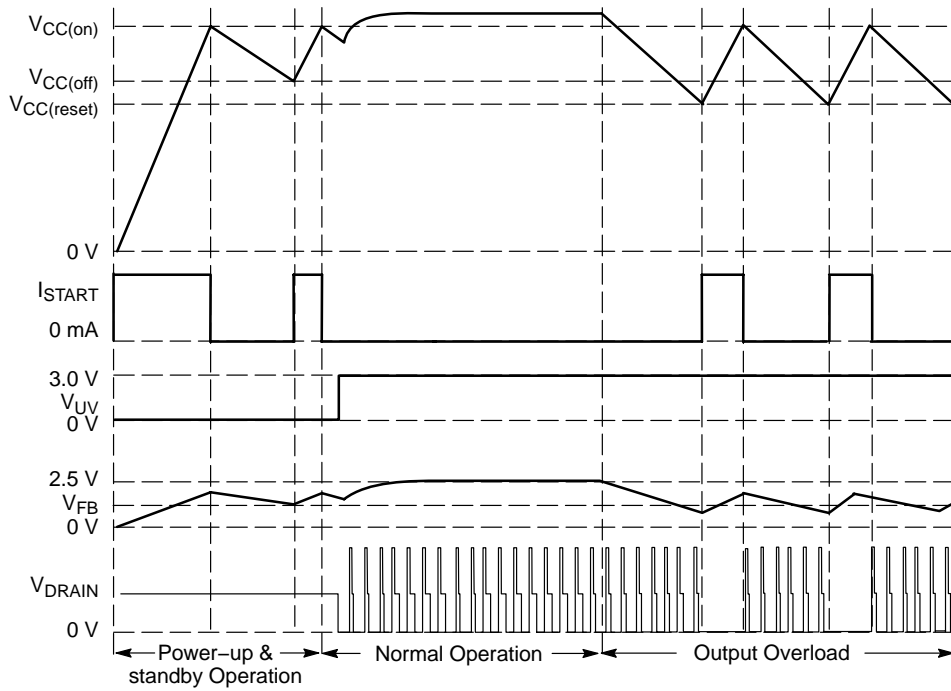
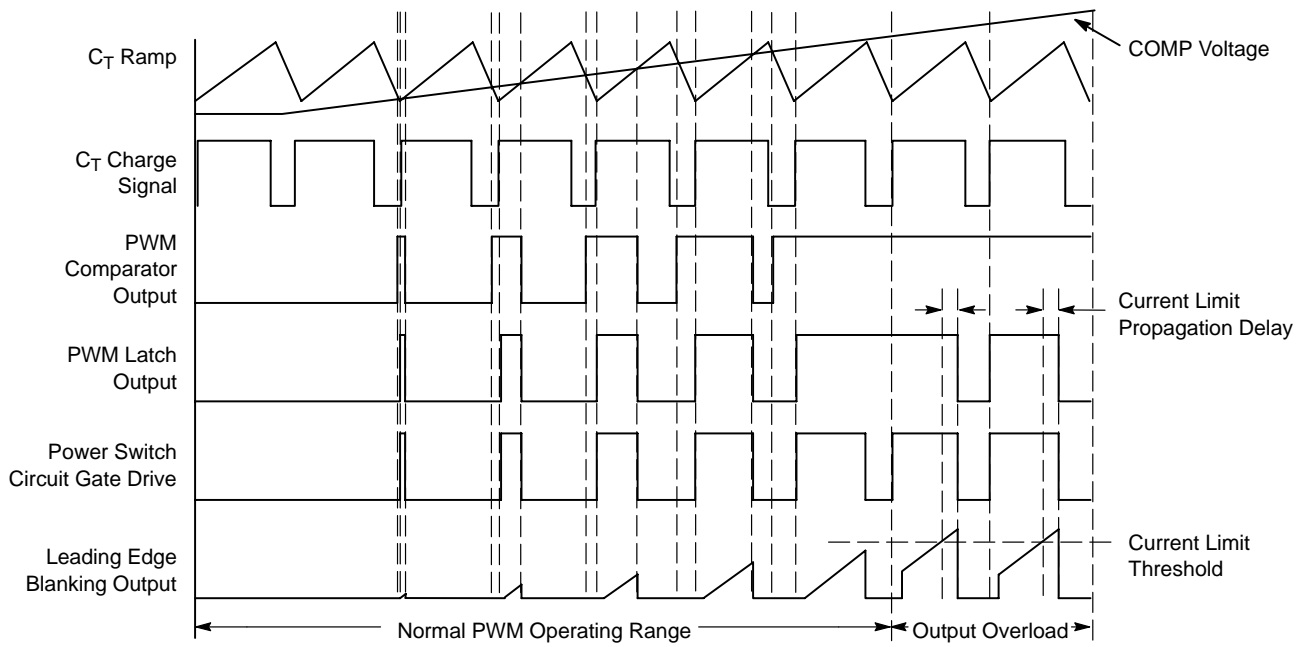

Figure 1. NCP1030/31 Functional Block Diagram

FUNCTIONAL PIN DESCRIPTION

Pin	Name	Function	Description
1	GND	Ground	Ground reference pin for the circuit.
2	C _T	Oscillator Frequency Selection	An external capacitor connected to this pin sets the oscillator frequency up to 1 MHz. The oscillator can be synchronized to a higher frequency by charging or discharging C _T to trip the internal 3.0 V/3.5 V comparator. If a fault condition exists, the power switch is disabled and the frequency is reduced by a factor of 7.
3	V _{FB}	Feedback Input	The regulated voltage is scaled down to 2.5 V by means of a resistor divider. Regulation is achieved by comparing the scaled voltage to an internal 2.5 V reference.
4	COMP	Error Amplifier Compensation	Requires external compensation network between COMP and V _{FB} pins. This pin is effectively grounded if faults are present.
5	OV	Line Overvoltage Shutdown	Line voltage (V _{in}) is scaled down using an external resistor divider such that the OV voltage reaches 2.5 V when line voltage reaches its maximum operating voltage.
6	UV	Line Undervoltage Shutdown	Line voltage is scaled down using an external resistor divider such that the UV voltage reaches 2.5 V when line voltage reaches its minimum operating voltage.
7	V _{CC}	Supply Voltage	This pin is connected to an external capacitor for energy storage. During Turn-On, the startup circuit sources current to charge the capacitor connected to this pin. When the supply voltage reaches V _{CC(on)} , the startup circuit turns OFF and the power switch is enabled if no faults are present. An external winding is used to supply power after initial startup to reduce power dissipation. V _{CC} should not exceed 16 V.
8	V _{DRAIN}	Power Switch and Startup Circuits	This pin directly connects the Power Switch and Startup Circuits to one of the transformer windings. The internal High Voltage Power Switch Circuit is connected between this pin and ground. V _{DRAIN} should not exceed 200 V.

NCP1030, NCP1031



NCP1030, NCP1031

MAXIMUM RATINGS

Rating	Symbol	Value	Unit
Power Switch and Startup Circuits Voltage	V_{DRAIN}	-0.3 to 200	V
Power Switch and Startup Circuits Input Current – NCP1030 – NCP1031	I_{DRAIN}	1.0 2.0	A
V_{CC} Voltage Range	V_{CC}	-0.3 to 16	V
All Other Inputs/Outputs Voltage Range	V_{IO}	-0.3 to 10	V
V_{CC} and All Other Inputs/Outputs Current	I_{IO}	100	mA
Operating Junction Temperature	T_J	-40 to 125	°C
Storage Temperature	T_{stg}	-55 to 150	°C
Power Dissipation ($T_J = 25^\circ\text{C}$, 2.0 Oz., 1.0 Sq Inch Printed Circuit Copper Clad) DM Suffix, Plastic Package Case 846A D Suffix, Plastic Package Case 751		0.69 0.93	W
Thermal Resistance, Junction to Air (2.0 Oz. Printed Circuit Copper Clad) DM Suffix, Plastic Package Case 846A 0.36 Sq. Inch 1.0 Sq. Inch D Suffix, Plastic Package Case 751 0.36 Sq. Inch 1.0 Sq. Inch	$R_{\theta JA}$	181 162 135 117	°C/W

Maximum ratings are those values beyond which device damage can occur. Maximum ratings applied to the device are individual stress limit values (not normal operating conditions) and are not valid simultaneously. If these limits are exceeded, device functional operation is not implied, damage may occur and reliability may be affected.

A. This device contains ESD protection circuitry and exceeds the following tests:

Pins 1–7: Human Body Model 2000V per MIL–STD–883, Method 3015.

Machine Model Method 200 V.

Pin 8 is connected to the High Voltage Startup and Power Switch Circuits and rated only to the maximum voltage rating of the part, or 200 V.

B. This device contains Latchup protection and exceeds ± 100 mA per JEDEC Standard JESD78.

NCP1030, NCP1031

DC ELECTRICAL CHARACTERISTICS ($V_{DRAIN} = 48\text{ V}$, $V_{CC} = 12\text{ V}$, $C_T = 560\text{ pF}$, $V_{UV} = 3\text{ V}$, $V_{OV} = 2\text{ V}$, $V_{FB} = 2.3\text{ V}$, $V_{COMP} = 2.5\text{ V}$, $T_J = -40^\circ\text{C}$ to 125°C , typical values shown are for $T_J = 25^\circ\text{C}$ unless otherwise noted.) (Note 1)

Characteristics	Symbol	Min	Typ	Max	Unit
STARTUP CONTROL					
Startup Circuit Output Current ($V_{FB} = V_{COMP}$) NCP1030 $T_J = 25^\circ\text{C}$ $V_{CC} = 0\text{ V}$ $V_{CC} = V_{CC(on)} - 0.2\text{ V}$ $T_J = -40^\circ\text{C}$ to 125°C $V_{CC} = 0\text{ V}$ $V_{CC} = V_{CC(on)} - 0.2\text{ V}$ NCP1031 $T_J = 25^\circ\text{C}$ $V_{CC} = 0\text{ V}$ $V_{CC} = V_{CC(on)} - 0.2\text{ V}$ $T_J = -40^\circ\text{C}$ to 125°C $V_{CC} = 0\text{ V}$ $V_{CC} = V_{CC(on)} - 0.2\text{ V}$	I_{START}	10 6.0	12.5 8.6	15 12	mA
V_{CC} Supply Monitor ($V_{FB} = 2.7\text{ V}$) Startup Threshold Voltage (V_{CC} Increasing) Minimum Operating V_{CC} After Turn-on (V_{CC} Increasing) Hysteresis Voltage	$V_{CC(on)}$ $V_{CC(off)}$ $V_{CC(hys)}$	9.6 7.0 –	10.2 7.6 2.6	10.6 8.0 –	V
Undervoltage Lockout Threshold Voltage, V_{CC} Decreasing ($V_{FB} = V_{COMP}$)	$V_{CC(reset)}$	6.0	6.6	7.0	V
Minimum Startup Voltage (Pin 8) $I_{START} = 0.5\text{ mA}$, $V_{CC} = V_{CC(on)} - 0.2\text{ V}$	$V_{START(min)}$	–	16.8	18.5	V

ERROR AMPLIFIER

Reference Voltage ($V_{COMP} = V_{FB}$, Follower Mode) $T_J = 25^\circ\text{C}$ $T_J = -40^\circ\text{C}$ to 125°C	V_{REF}	2.45 2.40	2.5 2.5	2.55 2.60	V
Line Regulation ($V_{CC} = 8\text{ V}$ to 16 V , $T_J = 25^\circ\text{C}$)	REG_{LINE}	–	1.0	5.0	mV
Input Bias Current ($V_{FB} = 2.3\text{ V}$)	I_{VFB}	–	0.1	1.0	μA
COMP Source Current	I_{SRC}	80	110	140	μA
COMP Sink Current ($V_{FB} = 2.7\text{ V}$)	I_{SNK}	200	550	900	μA
COMP Maximum Voltage ($I_{SRC} = 0\text{ }\mu\text{A}$)	$V_{C(max)}$	4.5	–	–	V
COMP Minimum Voltage ($I_{SNK} = 0\text{ }\mu\text{A}$, $V_{FB} = 2.7\text{ V}$)	$V_{C(min)}$	–	–	1.0	V
Open Loop Voltage Gain	A_{VOL}	–	80	–	dB
Gain Bandwidth Product	GBW	–	1.0	–	MHz

LINE UNDER/OVERVOLTAGE DETECTOR

Undervoltage Lockout ($V_{FB} = V_{COMP}$) Voltage Threshold (V_{in} Increasing) Voltage Hysteresis Input Bias Current	V_{UV} $V_{UV(hys)}$ I_{UV}	2.400 0.075 –	2.550 0.175 0	2.700 0.275 1.0	V V μA
Overvoltage Lockout ($V_{FB} = V_{COMP}$) Voltage Threshold (V_{in} Increasing) Voltage Hysteresis Input Bias Current	V_{OV} $V_{OV(hys)}$ I_{OV}	2.400 0.075 –	2.550 0.175 0	2.700 0.275 1.0	V V μA

1. Production testing for NCP1030DMR2 is performed at 25°C only; limits at -40°C and 125°C are guaranteed by design.

NCP1030, NCP1031

DC ELECTRICAL CHARACTERISTICS ($V_{DRAIN} = 48\text{ V}$, $V_{CC} = 12\text{ V}$, $C_T = 560\text{ pF}$, $V_{UV} = 3\text{ V}$, $V_{OV} = 2\text{ V}$, $V_{FB} = 2.3\text{ V}$, $V_{COMP} = 2.5\text{ V}$, $T_J = -40^\circ\text{C}$ to 125°C , typical values shown are for $T_J = 25^\circ\text{C}$ unless otherwise noted.) (Note 2)

Characteristics	Symbol	Min	Typ	Max	Unit
-----------------	--------	-----	-----	-----	------

OSCILLATOR

Frequency ($C_T = 560\text{ pF}$, Note 3) $T_J = 25^\circ\text{C}$ $T_J = -40^\circ\text{C}$ to 125°C	f_{OSC1}	275 260	300 –	325 325	kHz
Frequency ($C_T = 100\text{ pF}$)	f_{OSC2}	–	800	–	kHz
Charge Current ($V_{CT} = 3.25\text{ V}$)	$I_{CT(C)}$	–	215	–	μA
Discharge Current ($V_{CT} = 3.25\text{ V}$)	$I_{CT(D)}$	–	645	–	μA
Oscillator Ramp Peak Valley	V_{rpk} V_{rly}	– –	3.5 3.0	– –	V

PWM COMPARATOR

Maximum Duty Cycle	DC_{MAX}	70	75	80	%
--------------------	------------	----	----	----	---

POWER SWITCH CIRCUIT

Power Switch Circuit On-State Resistance ($I_D = 100\text{ mA}$) NCP1030 $T_J = 25^\circ\text{C}$ $T_J = 125^\circ\text{C}$ NCP1031 $T_J = 25^\circ\text{C}$ $T_J = 125^\circ\text{C}$	$R_{DS(on)}$	– – – –	4.1 6.0 2.1 3.5	7.0 12 3.0 6.0	Ω
Power Switch Circuit and Startup Circuit Breakdown Voltage ($I_D = 100\text{ }\mu\text{A}$, $T_J = 25^\circ\text{C}$)	$V_{(BR)DS}$	200	–	–	V
Power Switch Circuit and Startup Circuit Off-State Leakage Current ($V_{DRAIN} = 200\text{ V}$, $V_{UV} = 2.0\text{ V}$) $T_J = 25^\circ\text{C}$ $T_J = -40$ to 125°C	$I_{DS(off)}$	– –	13 –	25 50	μA
Switching Characteristics ($V_{DS} = 48\text{ V}$, $R_L = 100\text{ }\Omega$) Rise Time Fall Time	t_r t_f	– –	22 24	– –	ns

CURRENT LIMIT AND OVER TEMPERATURE PROTECTION

Current Limit Threshold ($T_J = 25^\circ\text{C}$) NCP1030 ($di/dt = 0.5\text{ A}/\mu\text{s}$) NCP1031 ($di/dt = 1.0\text{ A}/\mu\text{s}$)	I_{LIM}	350 700	515 1050	680 1360	mA
Propagation Delay, Current Limit Threshold to Power Switch Circuit Output (Leading Edge Blanking plus Current Limit Delay)	t_{PLH}	–	100	–	ns
Thermal Protection (Note 4) Shutdown Threshold (T_J Increasing) Hysteresis	T_{SHDN} T_{HYS}	125 –	150 45	– –	$^\circ\text{C}$

TOTAL DEVICE

Supply Current After UV Turn-On Power Switch Enabled Power Switch Disabled Non-Fault condition ($V_{FB} = 2.7\text{ V}$) Fault Condition ($V_{FB} = 2.7\text{ V}$, $V_{UV} = 2.0\text{ V}$)	I_{CC1} I_{CC2} I_{CC3}	2.0 – –	3.0 1.5 0.65	4.0 2.0 1.2	mA
--	---	---------------	--------------------	-------------------	----

2. Production testing for NCP1030DMR2 is performed at 25°C only; limits at -40°C and 125°C are guaranteed by design.
3. Oscillator frequency can be externally synchronized to the maximum frequency of the device.
4. Guaranteed by design only.

NCP1030, NCP1031

TYPICAL CHARACTERISTICS

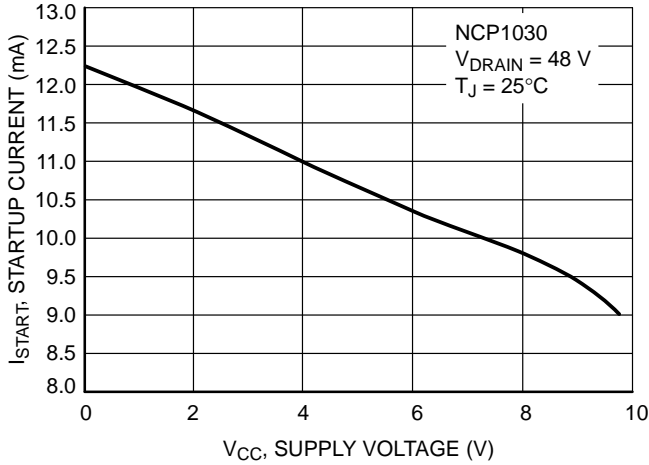

Figure 4. NCP1030 Startup Current vs. Supply Voltage

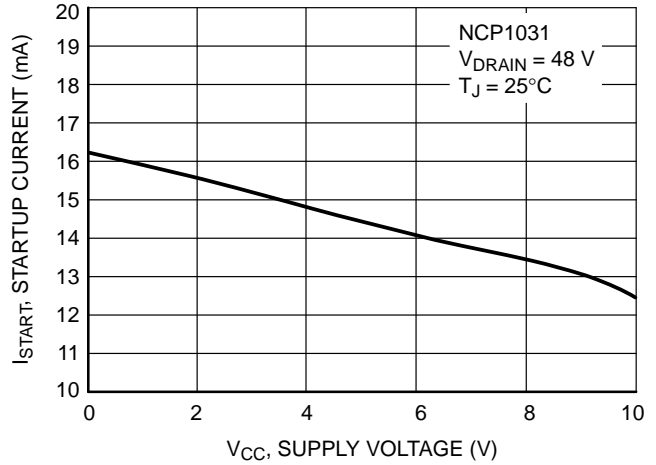

Figure 5. NCP1031 Startup Current vs. Supply Voltage

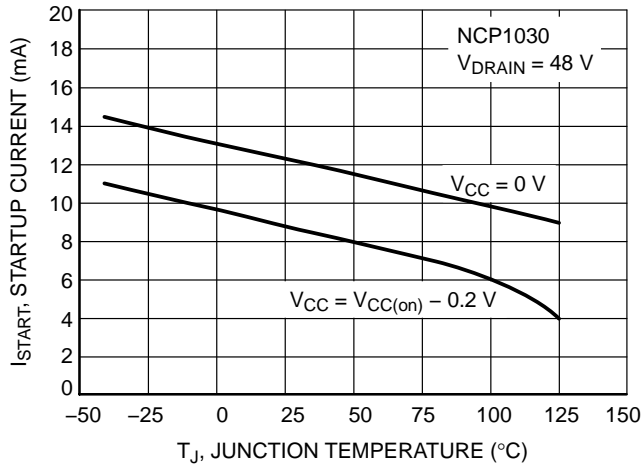

Figure 6. NCP1030 Startup Current vs. Junction Temperature

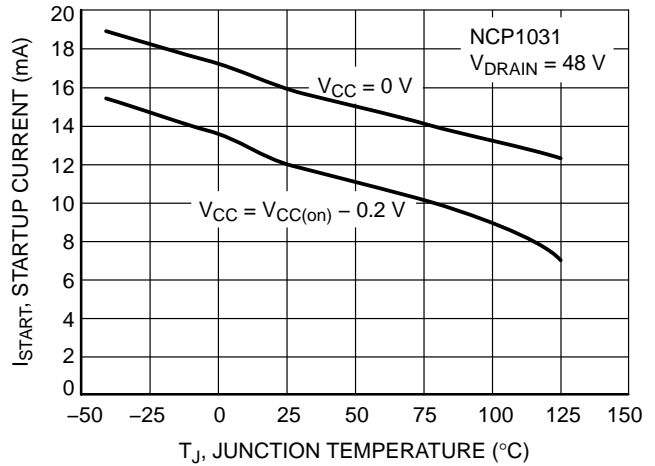

Figure 7. NCP1031 Startup Current vs. Junction Temperature

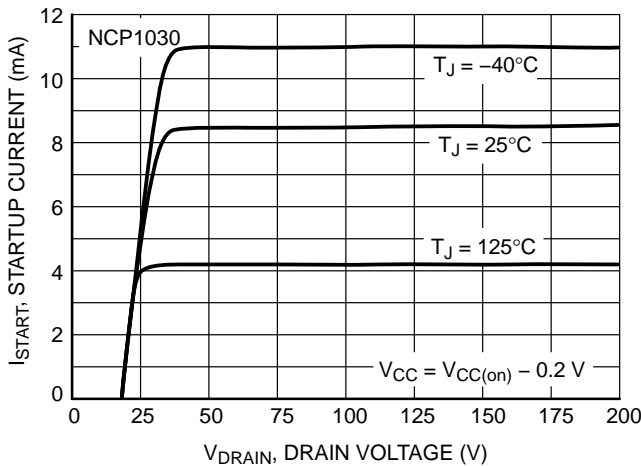

Figure 8. NCP1030 Startup Current vs. Drain Voltage

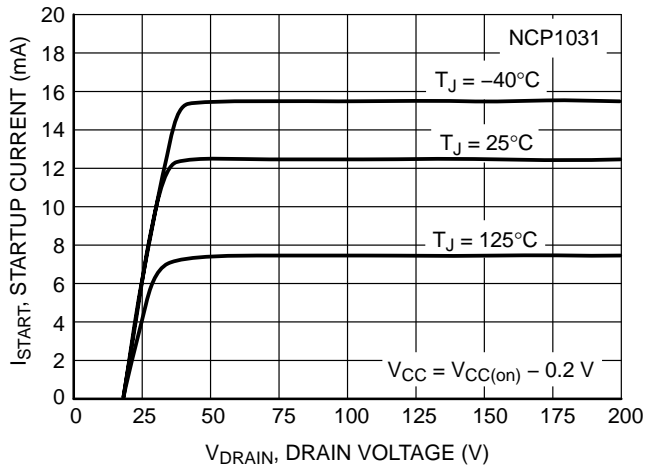

Figure 9. NCP1031 Startup Current vs. Drain Voltage

NCP1030, NCP1031

TYPICAL CHARACTERISTICS

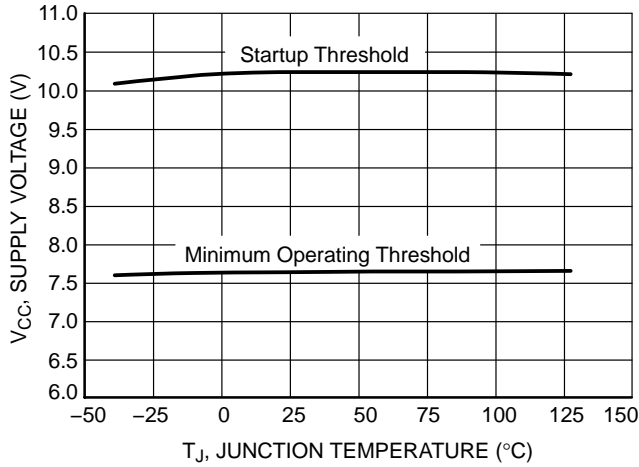

Figure 10. Supply Voltage Thresholds vs. Junction Temperature

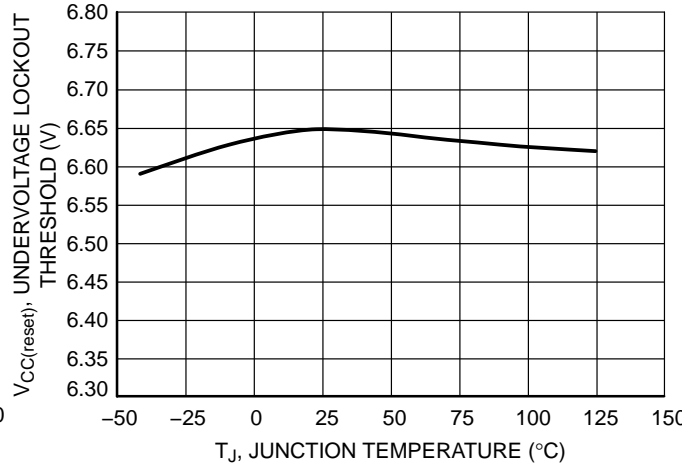

Figure 11. Undervoltage Lockout Threshold vs. Junction Temperature

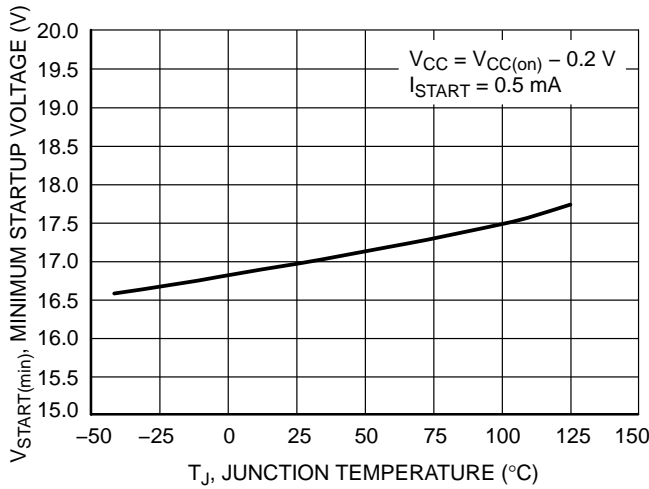

Figure 12. Minimum Startup Voltage vs. Junction Temperature

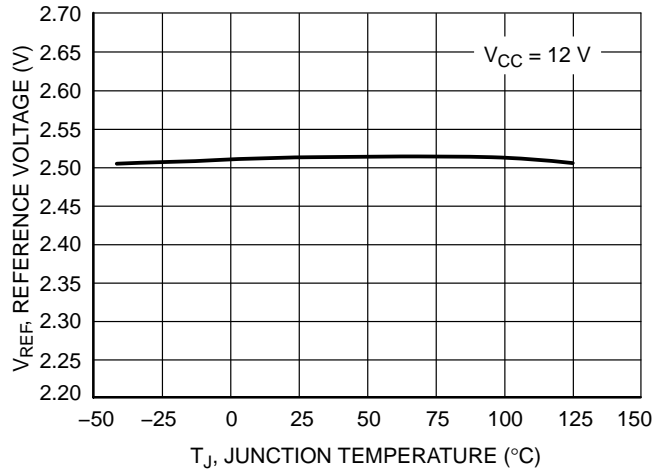

Figure 13. Reference Voltage vs. Junction Temperature

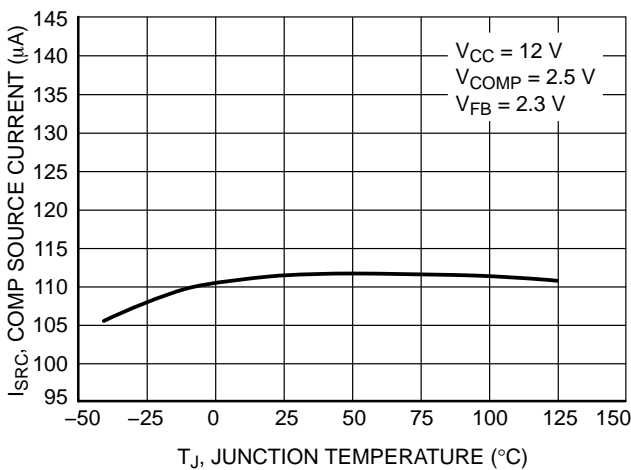

Figure 14. COMP Source Current vs. Junction Temperature

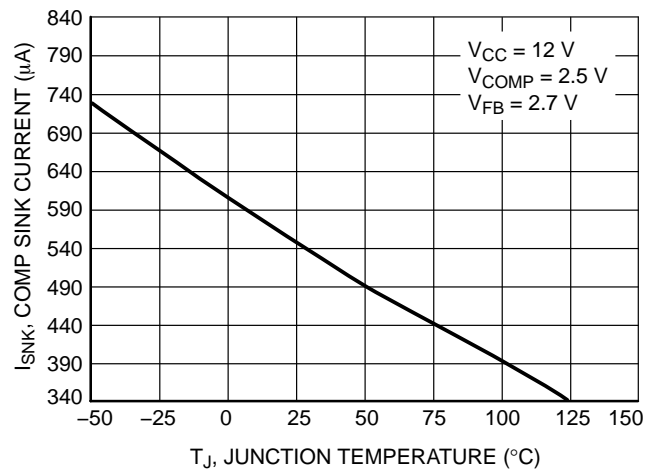
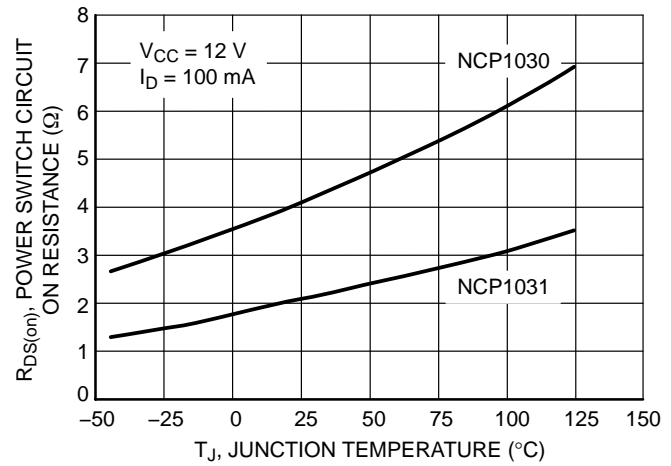
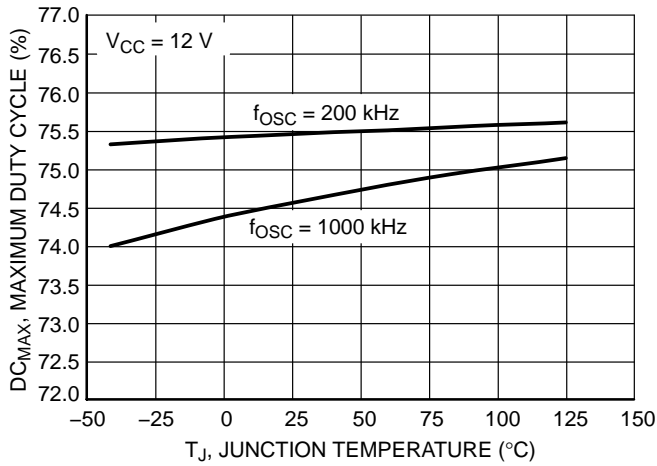
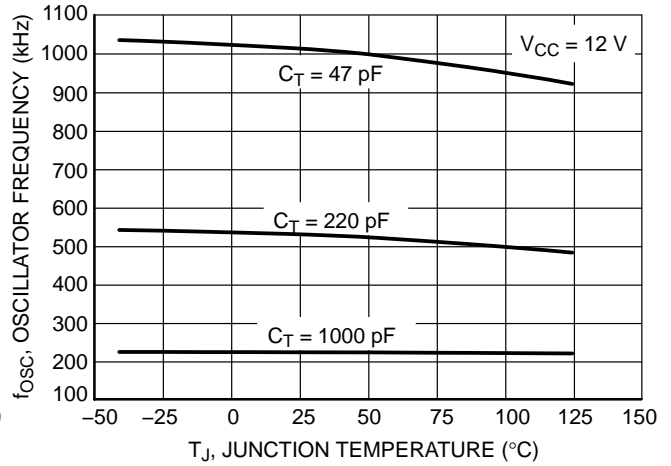
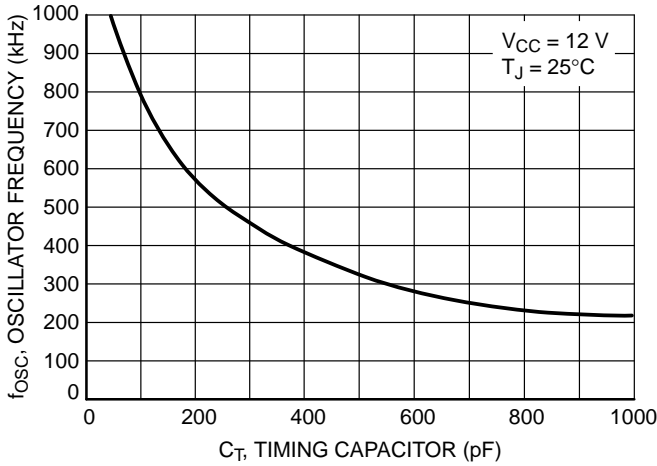
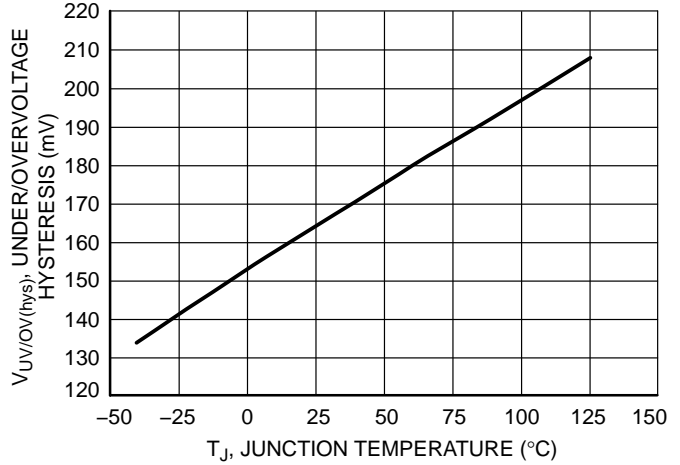
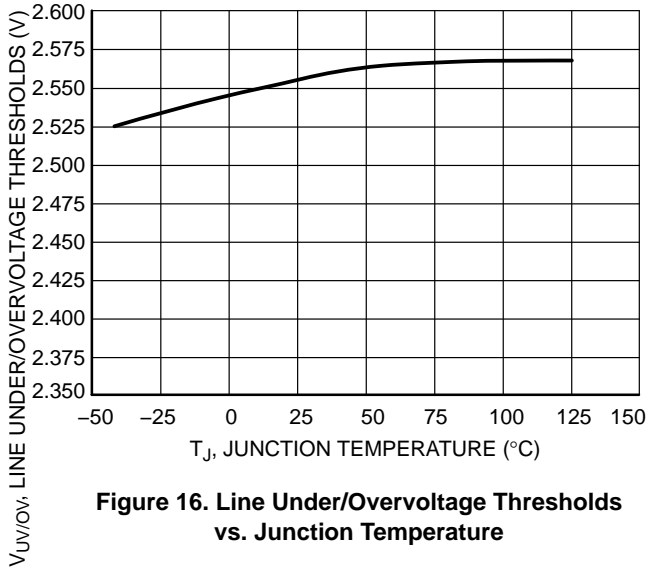

Figure 15. COMP Sink Current vs. Junction Temperature

NCP1030, NCP1031

TYPICAL CHARACTERISTICS



NCP1030, NCP1031

TYPICAL CHARACTERISTICS

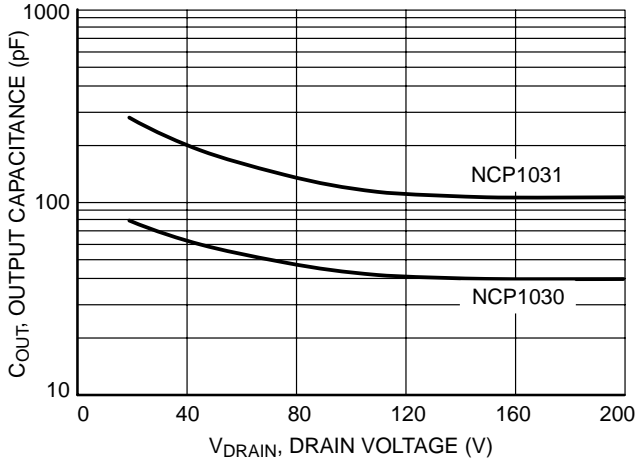

Figure 22. Power Switch Circuit Output Capacitance vs. Drain Voltage

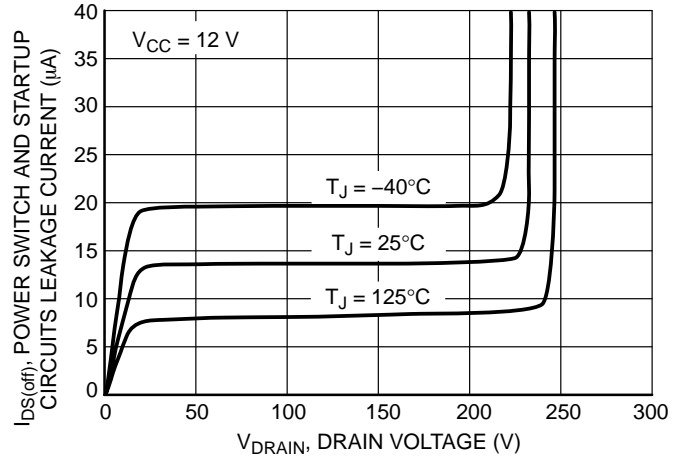

Figure 23. Power Switch Circuit and Startup Circuit Leakage Current vs. Drain Voltage

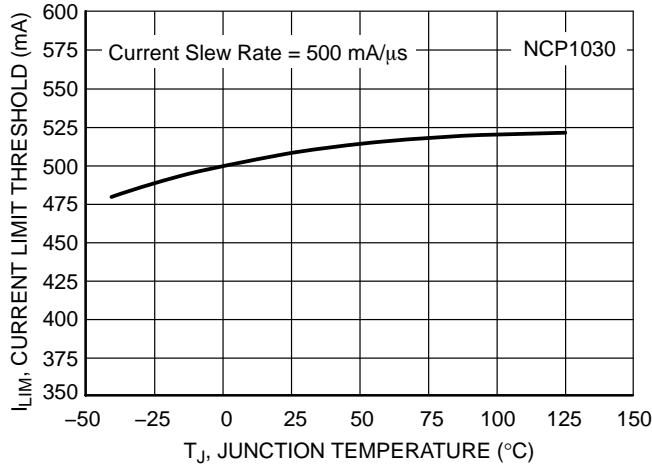

Figure 24. NCP1030 Current Limit Threshold vs. Junction Temperature

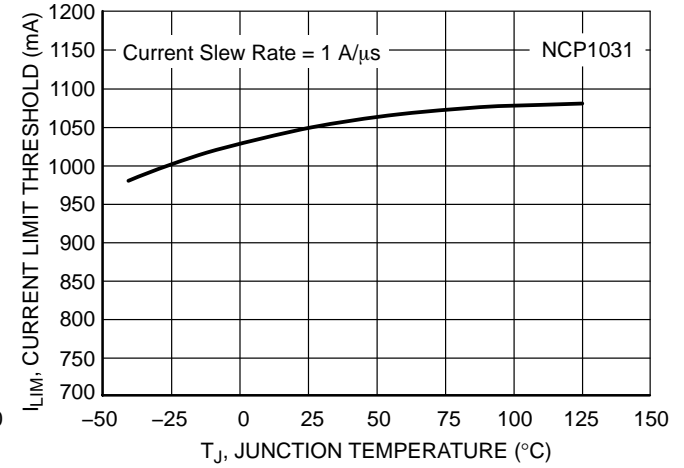

Figure 25. NCP1031 Current Limit Threshold vs. Junction Temperature

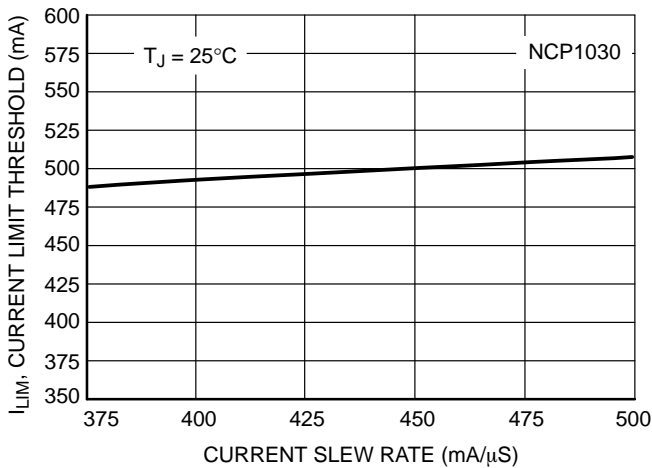

Figure 26. NCP1030 Current Limit Threshold vs. Current Slew Rate

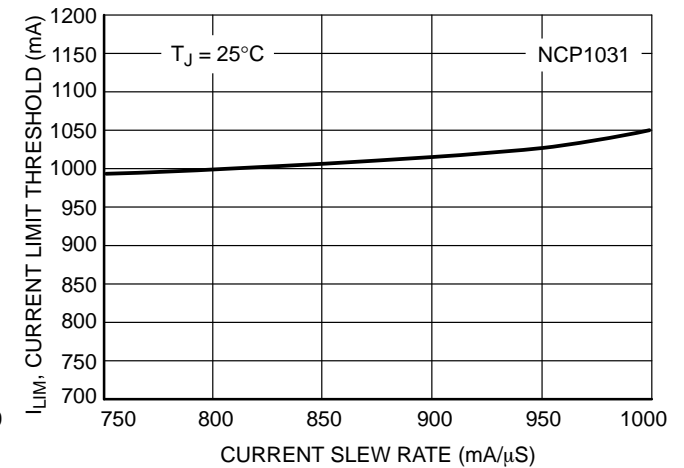

Figure 27. NCP1031 Current Limit Threshold vs. Current Slew Rate

NCP1030, NCP1031

TYPICAL CHARACTERISTICS

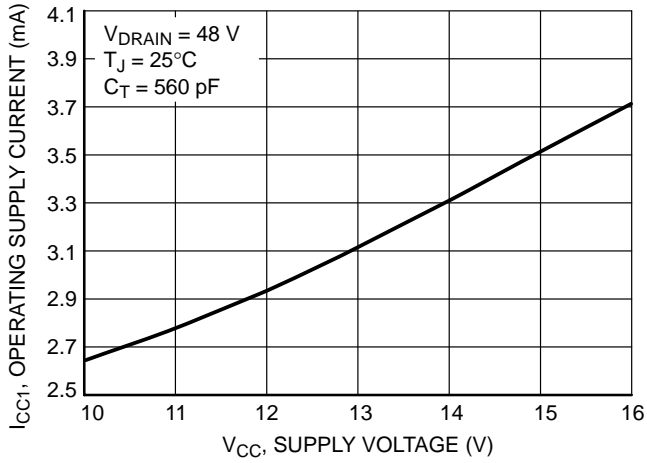

Figure 28. Operating Supply Current vs. Supply Voltage

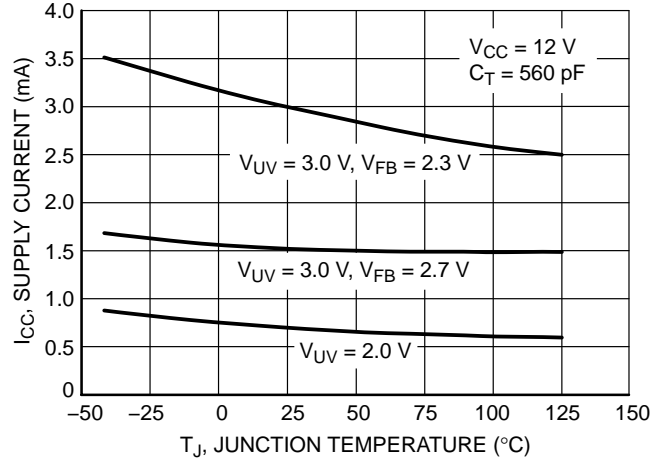

Figure 29. Supply Current vs. Junction Temperature

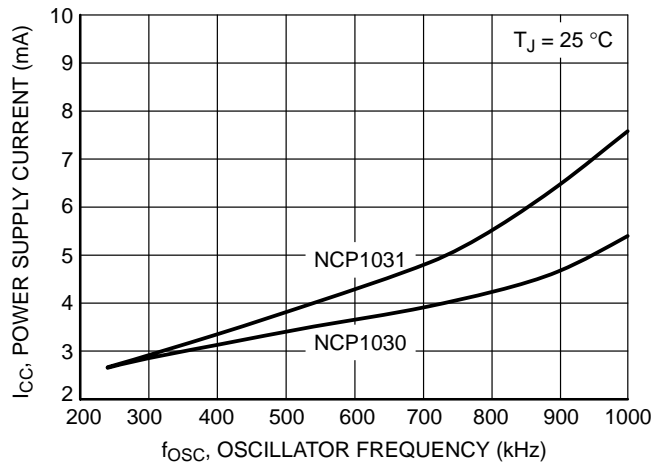

Figure 30. Operating Supply Current vs. Oscillator Frequency

NCP1030, NCP1031

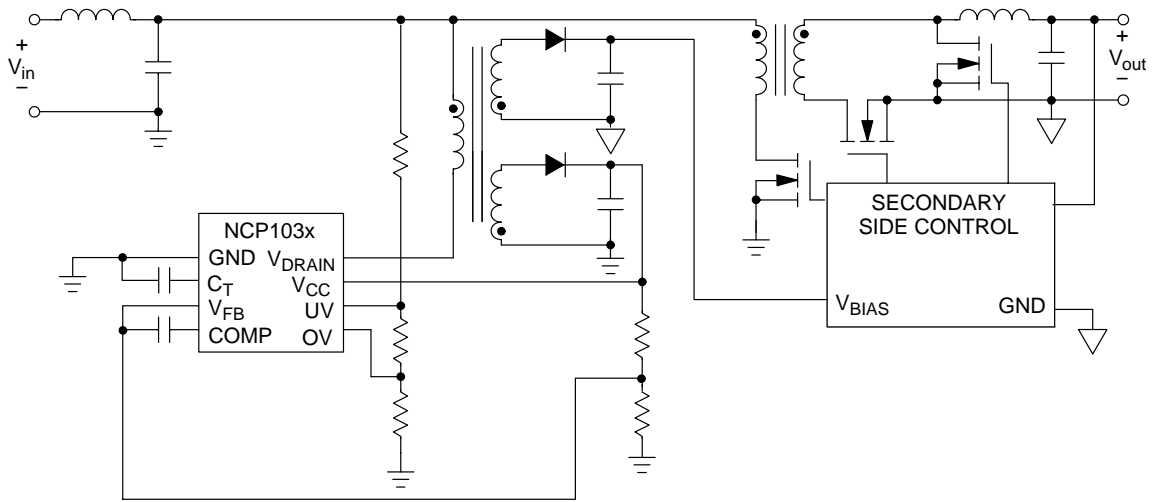

Figure 31. Secondary Side Bias Supply Configuration

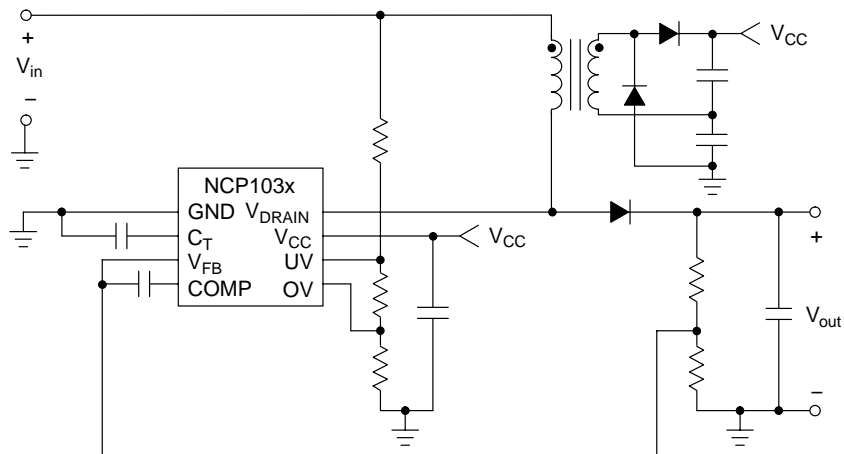

Figure 32. Boost Circuit Configuration

OPERATING DESCRIPTION

Introduction

The NCP1030 and NCP1031 are a family of miniature monolithic voltage-mode switching regulators designed for isolated and non-isolated bias supply applications. The internal startup circuit and the MOSFET are rated at 200 V, making them ideal for 48 V telecom and 42 V automotive applications. In addition, the NCP103x family can operate from an existing 12 V supply. This controller family is optimized for operation up to 1 MHz.

The NCP103x family incorporates in a single IC all the active power, control logic and protection circuitry required to implement, with a minimum of external components, several switching regulator applications, such as a secondary side bias supply or a low power dc-dc converter.

The NCP1030 is available in the space saving Micro8™ package and is targeted for applications requiring up to 3 W. The NCP1031 is targeted for applications up to 6 W and is available in the SO-8 package.

The NCP103x includes an extensive set of features including over temperature protection, cycle by cycle current limit, individual line under and overvoltage detection comparators with hysteresis, and regulator output undervoltage lockout with hysteresis, providing full protection during fault conditions. A description of each of the functional blocks is given below, and the representative block diagram is shown in Figure 2.

Startup Circuit and Undervoltage Lockout

The NCP103x contains an internal 200 V startup regulator that eliminates the need for external startup components. The startup regulator consists of a constant current source that supplies current from the input line (V_{in}) to the capacitor on the V_{CC} pin (C_{CC}). Once the V_{CC} voltage reaches approximately 10 V, the startup circuit is disabled and the Power Switch Circuit is enabled if no faults are present. During this self-bias mode, power to the NCP103x is supplied by the V_{CC} capacitor. The startup regulator turns ON again once V_{CC} reaches 7.5 V. This “7.5–10” mode of operation is known as Dynamic Self Supply (DSS). The NCP1030 and NCP1031 startup currents are 12 mA and 16 mA, respectively.

If V_{CC} falls below 7.5 V, the device enters a re-start mode. While in the re-start mode, the V_{CC} capacitor is allowed to discharge to 6.5 V while the Power Switch is enabled. Once the 6.5 V threshold is reached, the Power Switch Circuit is disabled and the startup regulator is enabled to charge the V_{CC} capacitor. The Power Switch is enabled again once the V_{CC} voltage reaches 10 V. Therefore, the external V_{CC} capacitor must be sized such that a voltage greater than 7.5 V is maintained on the V_{CC} capacitor while the converter output reaches regulation. Otherwise, the converter will enter the re-start mode. Equation (1) provides a guideline for the selection of the V_{CC} capacitor for a forward converter;

Forward:

$$C_{CC} = \frac{\cos^{-1} \left(1 - \frac{V_{OUT} \cdot N_P}{DC \cdot V_{in} \cdot N_S} \right) \times \sqrt{L_{OUT} C_{OUT}} \cdot I_{bias}}{2.6} \quad (\text{eq. 1})$$

where, I_{bias} is the bias current supplied by the V_{CC} capacitor including the IC bias current (I_{CC1}) and any additional current used to bias the feedback resistors (if used).

After initial startup, the V_{CC} pin should be biased above $V_{CC(off)}$ using an auxiliary winding. This will prevent the startup regulator from turning ON and reduce power dissipation. Also, the load should not be directly connected to the V_{CC} capacitor. Otherwise, the load may override the startup circuit. Figure 33 shows the recommended configuration for a non-isolated flyback converter.

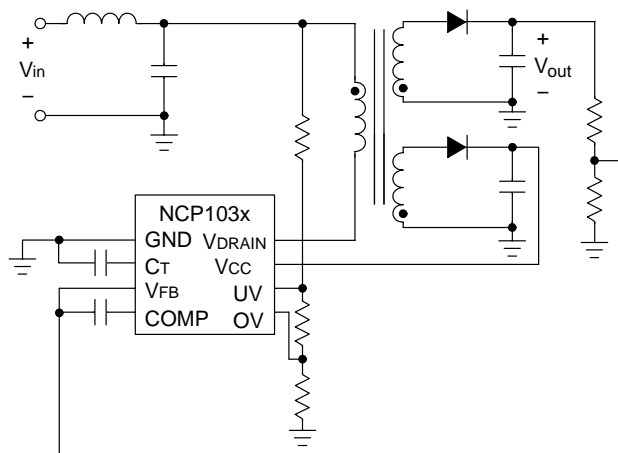

Figure 33. Non-Isolated Bias Supply Configuration

The maximum voltage rating of the startup circuit is 200 V. Power dissipation should be observed to avoid exceeding the maximum power dissipation of the package.

Error Amplifier

The internal error amplifier (EA) regulates the output voltage of the bias supply. It compares a scaled output voltage signal to an internal 2.5 V reference (V_{REF}) connected to its non-inverting input. The scaled signal is fed into the feedback pin (V_{FB}) which is the inverting input of the error amplifier.

The output of the error amplifier is available for frequency compensation and connection to the PWM comparator through the COMP pin. To insure normal operation, the EA compensation should be selected such that the EA frequency response crosses 0 dB below 80 kHz.

The error amplifier input bias current is less than 1 μ A over the operating range. The output source and sink currents are typically 110 μ A and 550 μ A, respectively.

Under load transient conditions, COMP may need to move from the bottom to the top of the C_T Ramp. A large current is required to complete the COMP swing if small resistors or large capacitors are used to implement the compensation network. In which case, the COMP swing will

be limited by the EA sink current, typically 110 μ A. Optimum transient response is obtained if the compensation components allow COMP to swing across its operating range in 1 cycle.

Line Under and Overvoltage Detector

The NCP103x incorporates individual line undervoltage (UV) and overvoltage (OV) shutdown circuits. The UV and OV thresholds are 2.5 V. A fault is present if the UV is below 2.5 V or if the OV voltage is above 2.5 V. The UV/OV detectors incorporate 175 mV hysteresis to prevent noise from triggering the shutdown circuits.

The UV/OV circuits can be biased using an external resistor divider from the input line as shown in Figure 34. The UV/OV pins should be bypassed using a capacitor to prevent triggering the UV or OV circuits during normal switching operation.

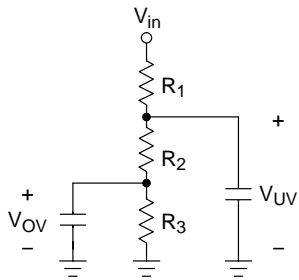

Figure 34. UV/OV Resistor Divider from the Input Line

The resistor divider must be sized to enable the controller once V_{in} is within the required operating range. While a UV or OV fault is present, switching is not allowed and the COMP pin is effectively grounded.

Either of these comparators can be used for a different function if UV or OV functions are not needed. For example, the UV/OV detectors can be used to implement an enable or disable function. If positive logic is used, the enable signal is applied to the UV pin while the OV pin is grounded. If negative logic is used, the disable signal is applied to the OV pin while biasing the UV pin from V_{CC} using a resistor divider.

Oscillator

The oscillator is optimized for operation up to 1 MHz and its frequency is set by the external timing capacitor (C_T) connected to the C_T pin. The oscillator has two modes of operation, free running and synchronized (sync). While in free running mode, an internal current source sequentially charges and discharges C_T generating a voltage ramp between 3.0 V and 3.5 V. Under normal operating conditions, the charge ($I_{CT(C)}$) and discharge ($I_{CT(D)}$) currents are typically 215 μ A and 645 μ A, respectively. The charge:discharge current ratio of 1:3 discharges C_T in 25 % of the total period. The Power Switch is disabled while C_T

is discharging, guaranteeing a maximum duty cycle of 75 % as shown in Figure 35.

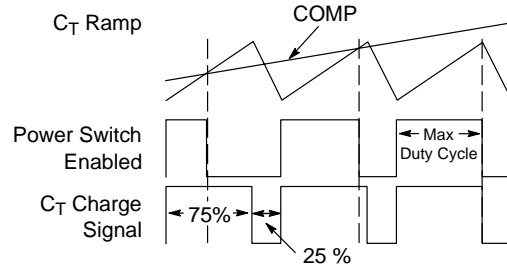

Figure 35. Maximum Duty Cycle vs COMP

Figure 18 shows the relationship between the operating frequency and C_T . If an UV fault is present, both $I_{CT(C)}$ and $I_{CT(D)}$ are reduced by a factor of 7, thus reducing the operating frequency by the same factor.

The oscillator can be synchronized to a higher frequency by capacitively coupling a synchronization pulse into the C_T pin. In sync mode, the voltage on the C_T pin needs to be driven above 3.5 V to trigger the internal comparator and complete the C_T charging period. However, pulsing the C_T pin before it reaches 3.5 V will reduce the p-p amplitude of the C_T Ramp as shown in Figure 36.

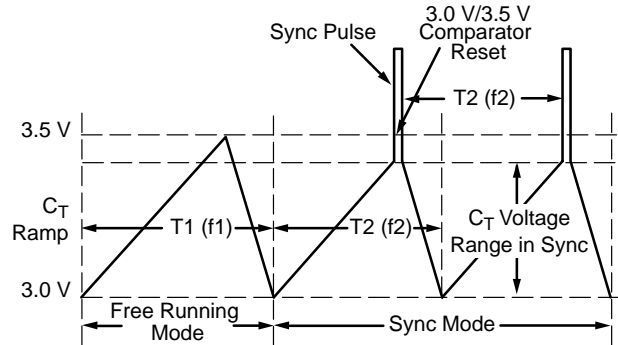

Figure 36. External Frequency Synchronization Waveforms

The oscillator frequency should be set no more that 25% below the target sync frequency to maintain an adequate voltage range and provide good noise immunity. A possible circuit to synchronize the oscillator is shown in Figure 37.

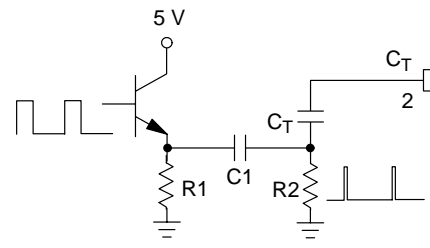

Figure 37. External Frequency Synchronization Circuit.

PWM Comparator and Latch

The Pulse Width Modulator (PWM) Comparator compares the error amplifier output (COMP) to the C_T Ramp and generates a proportional duty cycle. The Power Switch is enabled while the C_T Ramp is below COMP as shown in Figure 35. Once the C_T Ramp reaches COMP, the Power Switch is disabled. If COMP is at the bottom of the C_T Ramp, the converter operates at minimum duty cycle. While COMP increases, the duty cycle increases, until COMP reaches the peak of the C_T Ramp, at which point the controller operates at maximum duty cycle.

The C_T Charge Signal is filtered through a One Shot Pulse Generator to set the PWM Latch and enable switching at the beginning of each period. Switching is allowed while the C_T Ramp is below COMP and a current limit fault is not present.

The PWM Latch and Comparator propagation delay is typically 150 ns. If the system is designed to operate with a minimum ON time less than 150 ns, the converter will skip pulses. Skipping pulses is usually not a problem, unless operating at a frequency close to the audible range. Skipping pulses is more likely when operating at high frequencies during high line and minimum load condition.

A series resistor is included for ESD protection between the EA output and the COMP pin. Under normal operation, a 220 mV offset is observed between the C_T Ramp and the COMP crossing points. This is not a problem as the series resistor does not interact with the error amplifier transfer function.

Current Limit Comparator and Power Switch Circuit

The NCP103x monolithically integrates a 200 V Power Switch Circuit with control logic circuitry. The Power Switch Circuit is designed to directly drive the converter transformer. The characteristics of the Power Switch Circuit are well known. Therefore, the gate drive is tailored to control switching transitions and help limit electromagnetic interference (EMI). The Power Switch Circuit is capable of switching 200 V.

The Power Switch Circuit incorporates SENSEFET™ technology to monitor the drain current. A sense voltage is generated by driving a sense element, R_{SENSE} , with a current proportional to the drain current. The sense voltage is compared to an internal reference voltage on the non-inverting input of the Current Limit Comparator. If the sense voltage exceeds the reference level, the comparator resets the PWM Latch and switching is terminated. The NCP1030 and NCP1031 drain current limit thresholds are 0.5 A and 1.0 A, respectively.

Each time the Power Switch Circuit turns ON, a narrow voltage spike appears across R_{SENSE} . The spike is due to the Power Switch Circuit gate to source capacitance, transformer interwinding capacitance, and output rectifier

recovery time. This spike can cause a premature reset of the PWM Latch. A proprietary active Leading Edge Blanking (LEB) Circuit masks the current signal to prevent the voltage spike from resetting the PWM Latch. The active LEB masks the current signal until the Power Switch turn ON transition is complete. The adaptive LEB period provides better current limit control compared to a fixed blanking period.

The current limit propagation delay time is typically 100 ns. This time is measured from when an overcurrent fault appears at the Power Switch Circuit drain, to the start of the turn-off transition. Propagation delay must be factored in the transformer design to avoid transformer saturation.

Thermal Shutdown

Internal Thermal Shutdown circuitry is provided to protect the integrated circuit in the event the maximum junction temperature is exceeded. When activated, typically at 150°C, the Power Switch Circuit is disabled. Once the junction temperature falls below 105°C, the NCP103x is allowed to resume normal operation. This feature is provided to prevent catastrophic failures from accidental device overheating. It is not intended to be used as a substitute for proper heatsinking.

Application Considerations

A 2 W bias supply for a 48 V telecom system was designed using the NCP1030. The bias supply generates an isolated 12 V output. The circuit schematic is shown in Figure 38. Application Note AND8119/D describes the design of the bias supply.

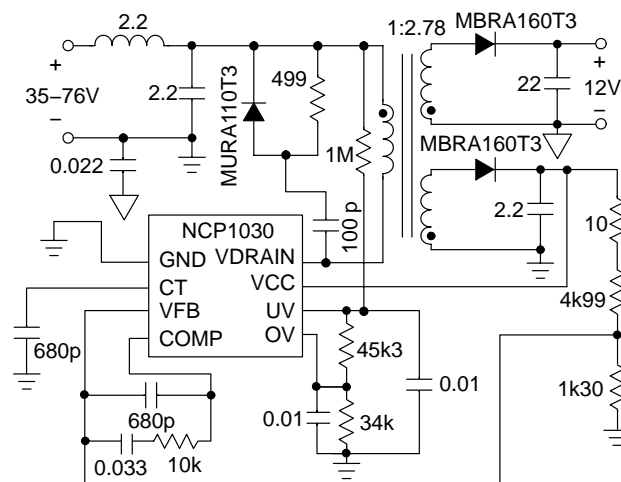
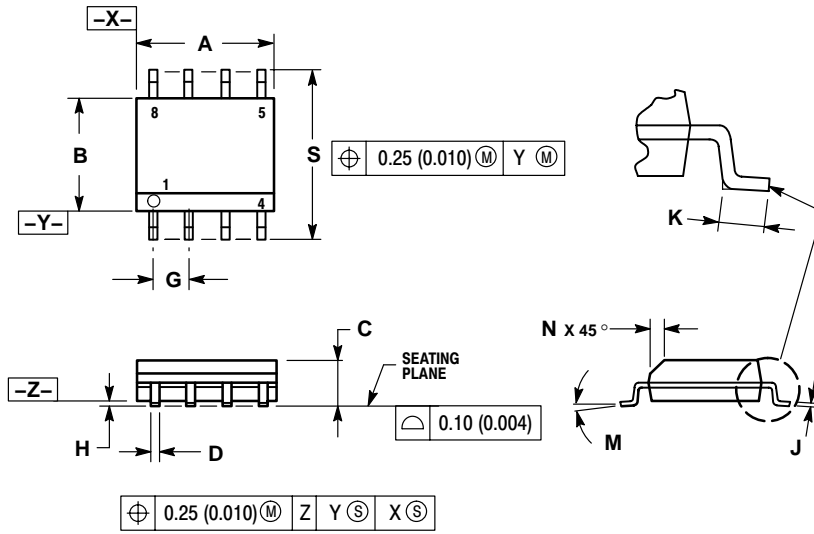

Figure 38. 2 W Isolated Bias Supply Schematic

NCP1030, NCP1031

PACKAGE DIMENSIONS

SO-8
D SUFFIX
CASE 751-07
ISSUE AC



NOTES:

1. DIMENSIONING AND TOLERANCING PER ANSI Y14.5M, 1982.
2. CONTROLLING DIMENSION: MILLIMETER.
3. DIMENSION A AND B DO NOT INCLUDE MOLD PROTRUSION.
4. MAXIMUM MOLD PROTRUSION 0.15 (0.006) PER SIDE.
5. DIMENSION D DOES NOT INCLUDE DAMBAR PROTRUSION. ALLOWABLE DAMBAR PROTRUSION SHALL BE 0.127 (0.005) TOTAL IN EXCESS OF THE D DIMENSION AT MAXIMUM MATERIAL CONDITION.
6. 751-01 THRU 751-06 ARE OBSOLETE. NEW STANDARD IS 751-07.

DIM	MILLIMETERS		INCHES	
	MIN	MAX	MIN	MAX
A	4.80	5.00	0.189	0.197
B	3.80	4.00	0.150	0.157
C	1.35	1.75	0.053	0.069
D	0.33	0.51	0.013	0.020
G	1.27 BSC		0.050 BSC	
H	0.10	0.25	0.004	0.010
J	0.19	0.25	0.007	0.010
K	0.40	1.27	0.016	0.050
M	0°	8°	0°	8°
N	0.25	0.50	0.010	0.020
S	5.80	6.20	0.228	0.244

SOLDERING FOOTPRINT

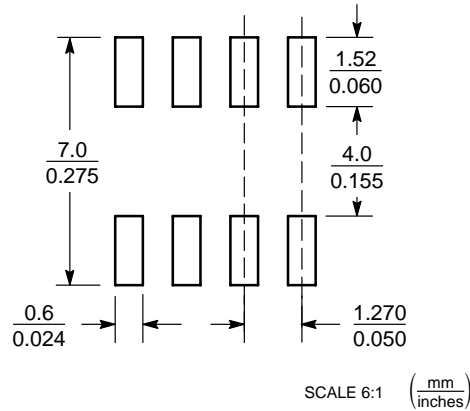

NCP1030, NCP1031

Micro8 is a trademark of International Rectifier. SENSEFET is a trademark of Semiconductor Components Industries, LLC. The products described herein (NCP1030 and NCP1031) may be covered by one or more of the following U.S. patents: 5,418,410; 5,477,175. There may be other patents pending.

ON Semiconductor and  are registered trademarks of Semiconductor Components Industries, LLC (SCILLC). SCILLC reserves the right to make changes without further notice to any products herein. SCILLC makes no warranty, representation or guarantee regarding the suitability of its products for any particular purpose, nor does SCILLC assume any liability arising out of the application or use of any product or circuit, and specifically disclaims any and all liability, including without limitation special, consequential or incidental damages. "Typical" parameters which may be provided in SCILLC data sheets and/or specifications can and do vary in different applications and actual performance may vary over time. All operating parameters, including "Typicals" must be validated for each customer application by customer's technical experts. SCILLC does not convey any license under its patent rights nor the rights of others. SCILLC products are not designed, intended, or authorized for use as components in systems intended for surgical implant into the body, or other applications intended to support or sustain life, or for any other application in which the failure of the SCILLC product could create a situation where personal injury or death may occur. Should Buyer purchase or use SCILLC products for any such unintended or unauthorized application, Buyer shall indemnify and hold SCILLC and its officers, employees, subsidiaries, affiliates, and distributors harmless against all claims, costs, damages, and expenses, and reasonable attorney fees arising out of, directly or indirectly, any claim of personal injury or death associated with such unintended or unauthorized use, even if such claim alleges that SCILLC was negligent regarding the design or manufacture of the part. SCILLC is an Equal Opportunity/Affirmative Action Employer. This literature is subject to all applicable copyright laws and is not for resale in any manner.

PUBLICATION ORDERING INFORMATION

LITERATURE FULFILLMENT:

Literature Distribution Center for ON Semiconductor
P.O. Box 61312, Phoenix, Arizona 85082-1312 USA
Phone: 480-829-7710 or 800-344-3860 Toll Free USA/Canada
Fax: 480-829-7709 or 800-344-3867 Toll Free USA/Canada
Email: orderlit@onsemi.com

N. American Technical Support: 800-282-9855 Toll Free
USA/Canada

Japan: ON Semiconductor, Japan Customer Focus Center
2-9-1 Kamimeguro, Meguro-ku, Tokyo, Japan 153-0051
Phone: 81-3-5773-3850

ON Semiconductor Website: <http://onsemi.com>

Order Literature: <http://www.onsemi.com/litorder>

For additional information, please contact your
local Sales Representative.