

Description

The GMM7328100BS/SG is a 8M x 32 bits Dynamic RAM MODULE which is assembled 16 pieces of 4M x 4bit DRAMs in 24 pin SOJ package on both sides the printed circuit board with decoupling capacitors. The GMM7328100BS/SG is optimized for application to the systems which are required high density and large capacity such as main memory of the computers and an image memory systems, and to the others which are requested compact size. The GMM7328100BS/SG provides common data inputs and outputs.

- GMM7328100BS/SG (Both Side)

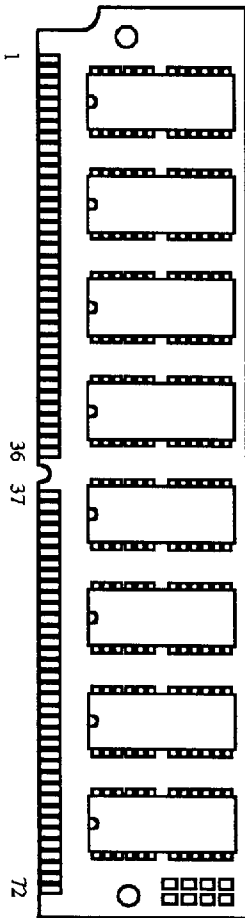

Features

- 72 pins Single In-Line Package
 - GMM7328100BS : Solder plating
 - GMM7328100BSG : Gold plating
- Fast Page Mode Capability
- Single Power Supply
- Fast Access Time & Cycle Time

(Unit: ns)

	t _{RAC}	t _{CAC}	t _{RC}	t _{PC}
GMM7328100BS/SG-6	60	15	110	40
GMM7328100BS/SG-7	70	18	130	45
GMM7328100BS/SG-8	80	20	150	50

- Low Power
 - Active : 4,928/4,488/4,048 mW (MAX)
 - Standby : 88mW (CMOS level : MAX)
- RAS Only Refresh, $\overline{\text{CAS}}$ before $\overline{\text{RAS}}$ Refresh, Hidden Refresh Capability
- All inputs and outputs TTL Compatible
- 2048 Refresh Cycles/ 32ms

Pin Configuration (Top View)

Pin	Symbol	Pin	Symbol	Pin	Symbol	Pin	Symbol
1	V _{SS}	19	A ₁₀	37	NC	55	DQ ₁₁
2	DQ ₀	20	DQ ₄	38	NC	56	DQ ₂₇
3	DQ ₁₆	21	DQ ₂₀	39	V _{SS}	57	DQ ₁₂
4	DQ ₁	22	DQ ₅	40	$\overline{\text{CAS}}_0$	58	DQ ₂₈
5	DQ ₁₇	23	DQ ₂₁	41	$\overline{\text{CAS}}_2$	59	V _{CC}
6	DQ ₂	24	DQ ₆	42	$\overline{\text{CAS}}_3$	60	DQ ₂₉
7	DQ ₁₈	25	DQ ₂₂	43	$\overline{\text{CAS}}_1$	61	DQ ₁₃
8	DQ ₃	26	DQ ₇	44	$\overline{\text{RAS}}_0$	62	DQ ₃₀
9	DQ ₁₉	27	DQ ₂₃	45	$\overline{\text{RAS}}_1$	63	DQ ₁₄
10	V _{CC}	28	A ₇	46	NC	64	DQ ₃₁
11	NC	29	NC	47	$\overline{\text{WE}}$	65	DQ ₁₅
12	A ₀	30	V _{CC}	48	NC	66	NC
13	A ₁	31	A ₈	49	DQ ₈	67	PD ₁
14	A ₂	32	$\overline{\text{A}}_9$	50	DQ ₂₄	68	PD ₂
15	A ₃	33	$\overline{\text{RAS}}_3$	51	DQ ₉	69	PD ₃
16	A ₄	34	$\overline{\text{RAS}}_2$	52	DQ ₂₅	70	PD ₄
17	A ₅	35	NC	53	DQ ₁₀	71	NC
18	A ₆	36	NC	54	DQ ₂₆	72	V _{SS}

Block Diagram

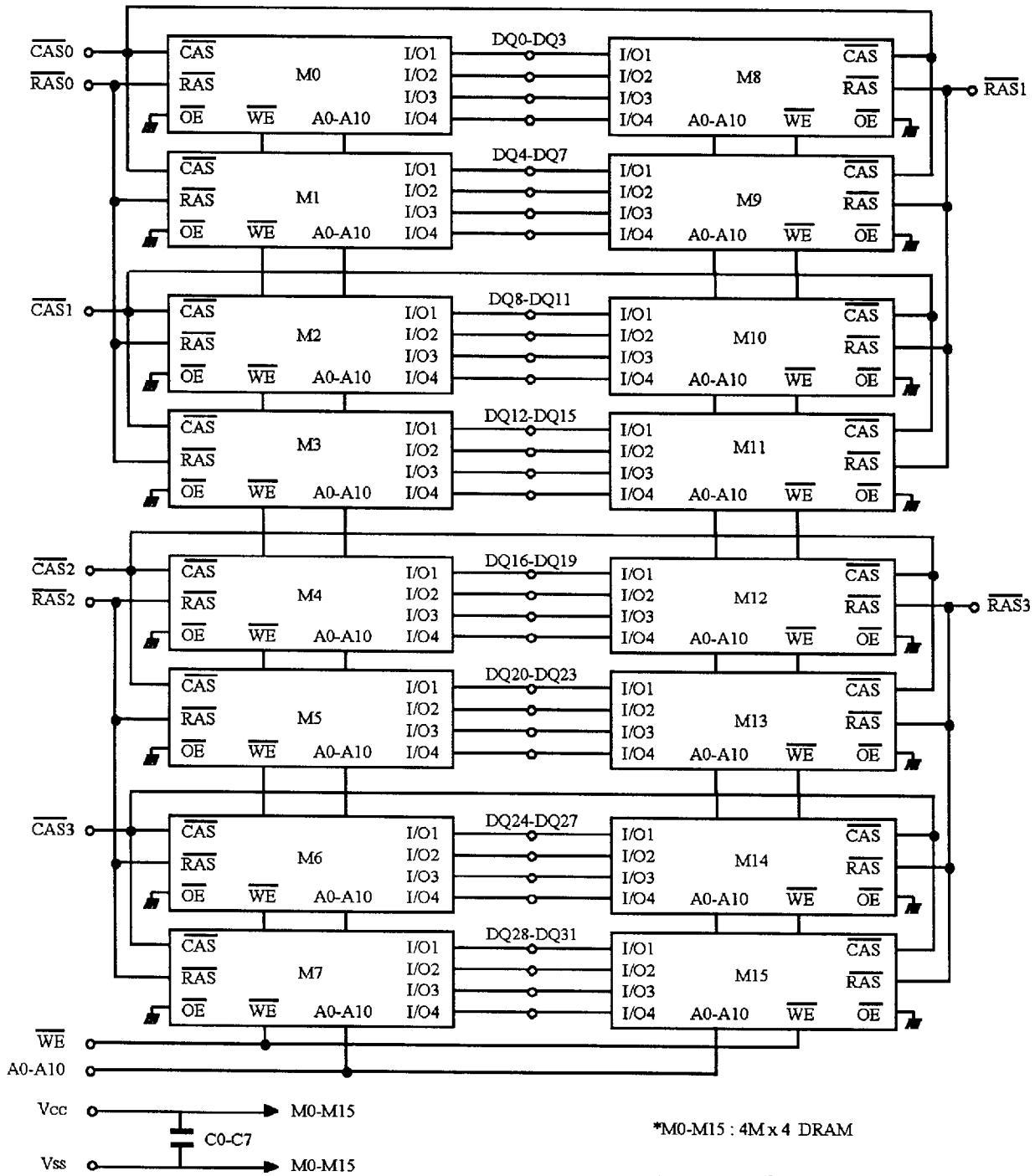

Pin Description

Pin	Function	Pin	Function
A0-A10	Address Inputs	PD1-PD4	Presence Detect
DQ0-DQ31	Data Input/Output	V _{cc}	Power (+5V)
$\overline{\text{RAS0-RAS3}}$	Row Address Strobe	V _{ss}	Ground
$\overline{\text{CAS0-CAS3}}$	Column Address Strobe	NC	No Connection
$\overline{\text{WE}}$	Read/Write Enable		

Presence Detect Pins (Optional)

Pin	60ns	70ns	80ns
PD1	NC	NC	NC
PD2	V _{ss}	V _{ss}	V _{ss}
PD3	NC	V _{ss}	NC
PD4	NC	NC	V _{ss}

Absolute Maximum Ratings*

Symbol	Parameter	Rating	Unit
T _A	Ambient Temperature under Bias	0 ~ 70	°C
T _{STG}	Storage Temperature (Plastic)	-55 ~ 125	°C
V _{IN} /V _{OUT}	Voltage on any Pin Relative to V _{ss}	-1.0 ~ 7.0	V
V _{CC}	Power Supply Voltage	-1.0 ~ 7.0	V
I _{OUT}	Short Circuit Output Current	50	mA
P _D	Power Dissipation	16	W

*Note: 1. Stress greater than above "Absolute Maximum Ratings" may cause permanent damage to the device.

Recommended DC Operating Conditions (T_A = 0 ~ 70°C)

Symbol	Parameter	Min	Typ	Max	Unit	Note
V _{CC}	Supply Voltage	4.5	5.0	5.5	V	1
V _{IH}	Input High Voltage	2.4	-	6.5	V	1
V _{IL}	Input Low Voltage	-1.0	-	0.8	V	1

*Note: 1. All voltages referenced to V_{ss}.

DC Electrical Characteristics ($V_{CC} = 5V \pm 10\%$, $T_A = 0 \sim 70^\circ C$)

Symbol	Parameter	Min	Max	Unit	Note	
V_{OH}	Output Level Output "H" Level Voltage ($I_{OUT} = -5mA$)	2.4	V_{CC}	V		
V_{OL}	Output Level Output "L" Level Voltage ($I_{OUT} = 4.2mA$)	0	0.4	V		
I_{CC1}	Operating Current Average Power Supply Operating Current (\overline{RAS} , \overline{CAS} , Address Cycling: $t_{RC} = t_{RC\ min}$)	60 ns	-	896	mA	1, 2
		70 ns	-	816		
		80 ns	-	736		
I_{CC2}	Standby Current (TTL) Power Supply Standby Current (\overline{RAS} , $\overline{CAS} = V_{IH}$)	-	32	mA		
I_{CC3}	\overline{RAS} Only Refresh Current Average Power Supply Current \overline{RAS} Only Mode (\overline{RAS} Cycling, $\overline{CAS} = V_{IH}$, $t_{RC} = t_{RC\ min}$)	60 ns	-	896	mA	2
		70 ns	-	816		
		80 ns	-	736		
I_{CC4}	Fast Page Mode Current Average Power Supply Current Fast Page Mode ($\overline{RAS} = V_{IL}$, \overline{CAS} , Address Cycling: $t_{RC} = t_{RC\ min}$)	60 ns	-	656	mA	1, 3
		70 ns	-	576		
		80 ns	-	536		
I_{CC5}	Standby Current (CMOS) Power Supply Standby Current (\overline{RAS} , $\overline{CAS} \geq V_{CC} - 0.2V$)	-	16	mA		
I_{CC6}	\overline{CAS} before \overline{RAS} Refresh Current ($t_{RC} = t_{RC\ min}$)	60 ns	-	896	mA	
		70 ns	-	816		
		80 ns	-	736		
I_{CC7}	Standby Current $\overline{RAS} = V_{IH}$ $\overline{CAS} = V_{IL}$ $D_{OUT} = \text{Enable}$	-	80	mA	1	
$I_{(I)}$	Input Leakage Current Any Input ($0V \leq V_{IN} \leq 7V$) All Other Pins Not Under Test = 0V	-160	160	μA		
$I_{(O)}$	Output Leakage Current (D_{OUT} is Disabled, $0V \leq V_{OUT} \leq 7V$)	-20	20	μA		

Note: 1. I_{CC} depends on output load condition when the device is selected. $I_{CC(max)}$ is specified at the output open condition.

2. Address can be changed once or less while $\overline{RAS} = V_{IL}$.

3. Address can be changed once or less while $\overline{CAS} = V_{IH}$.

Capacitance ($V_{CC} = 5V \pm 10\%$, $T_A = 25^\circ C$, $f = 1MHz$)

Symbol	Parameter	Min	Max	Unit	Note
C ₁₁	Input Capacitance (A0~A10)	-	60	pF	1
C ₁₂	Input Capacitance (\overline{WE})	-	70	pF	1, 2
C ₁₃	Input Capacitance ($\overline{RAS0} \sim \overline{RAS3}$)	-	40	pF	1, 2
C ₁₄	Input Capacitance ($\overline{CAS0} \sim \overline{CAS3}$)	-	30	pF	1, 2
C ₁₀	I/O Capacitance (DQ0~DQ31)	-	17	pF	1, 2

Note: 1. Capacitance measured with Boonton Meter or effective capacitance measuring method.
 2. CAS = V_{IH} to disable DOUT.

AC Electrical Characteristics ($V_{CC} = 5V \pm 10\%$, $T_A = 0 \sim 70^\circ C$, Notes 1, 15)

The GMM7328100BS/SG writes data only in early write cycle ($twcs \geq twcs(\min)$).
 Delayed write cycle is not available because of I/O common.

Read, Write and Refresh Cycle (Common Parameters)

Symbol	Parameter	GMM7328100 BS/SG-6		GMM7328100 BS/SG-7		GMM7328100 BS/SG-8		Unit	Note
		Min	Max	Min	Max	Min	Max		
t _{RC}	Random Read or Write Cycle Time	110	-	130	-	150	-	ns	
t _{RP}	\overline{RAS} Precharge Time	40	-	50	-	60	-	ns	
t _{RAS}	\overline{RAS} Pulse Width	60	10,000	70	10,000	80	10,000	ns	
t _{CAS}	\overline{CAS} Pulse Width	15	10,000	18	10,000	20	10,000	ns	
t _{ASR}	Row Address Setup Time	0	-	0	-	0	-	ns	
t _{RAH}	Row Address Hold Time	10	-	10	-	10	-	ns	
t _{ASC}	Column Address Setup Time	0	-	0	-	0	-	ns	
t _{CAH}	Column Address Hold Time	10	-	15	-	15	-	ns	
t _{RCD}	\overline{RAS} to \overline{CAS} Delay Time	20	45	20	52	20	60	ns	9
t _{RAD}	\overline{RAS} to Column Address Delay Time	15	30	15	35	15	40	ns	10
t _{RSH}	\overline{RAS} Hold Time	15	-	18	-	20	-	ns	
t _{CSH}	\overline{CAS} Hold Time	60	-	70	-	80	-	ns	
t _{CRP}	\overline{CAS} to \overline{RAS} Precharge Time	5	-	5	-	5	-	ns	
t _T	Transition Time (Rise and Fall)	3	50	3	50	3	50	ns	8
t _{REF}	Refresh Period	-	32	-	32	-	32	ms	

Read Cycle

Symbol	Parameter	GMM7328100 BS/SG-6		GMM7328100 BS/SG-7		GMM7328100 BS/SG-8		Unit	Note
		Min	Max	Min	Max	Min	Max		
t _{RAC}	Access Time from $\overline{\text{RAS}}$	-	60	-	70	-	80	ns	2, 3
t _{CAC}	Access Time from $\overline{\text{CAS}}$	-	15	-	18	-	20	ns	3, 4
t _{AA}	Access Time from Column Address	-	30	-	35	-	40	ns	3, 5, 14
t _{RCS}	Read Command Setup Time	0	-	0	-	0	-	ns	
t _{RCH}	Read Command Hold Time to $\overline{\text{CAS}}$	0	-	0	-	0	-	ns	6
t _{RRH}	Read Command Hold Time to $\overline{\text{RAS}}$	0	-	0	-	0	-	ns	6
t _{RAL}	Column Address to $\overline{\text{RAS}}$ Lead Time	30	-	35	-	40	-	ns	
t _{OFF}	Output Buffer Turn-off Time	-	15	-	15	-	15	ns	7
t _{CLZ}	$\overline{\text{CAS}}$ to Output in low-Z	0	-	0	-	0	-	ns	
t _{CAL}	Column Address to $\overline{\text{CAS}}$ Lead Time	30	-	35	-	40	-	ns	
t _{OH}	Output Data Hold Time	3	-	3	-	3	-	ns	

Write Cycle

Symbol	Parameter	GMM7328100 BS/SG-6		GMM7328100 BS/SG-7		GMM7328100 BS/SG-8		Unit	Note
		Min	Max	Min	Max	Min	Max		
t _{WCS}	Write Command Setup Time	0	-	0	-	0	-	ns	11
t _{WCH}	Write Command Hold Time	10	-	15	-	15	-	ns	
t _{WP}	Write Command Pulse Width	10	-	10	-	10	-	ns	
t _{RWL}	Write Command to $\overline{\text{RAS}}$ Lead Time	15	-	18	-	20	-	ns	
t _{CWL}	Write Command to $\overline{\text{CAS}}$ Lead Time	15	-	18	-	20	-	ns	
t _{DS}	Data-in Setup Time	0	-	0	-	0	-	ns	12
t _{DH}	Data-in Hold Time	10	-	15	-	20	-	ns	12

Refresh Cycle

Symbol	Parameter	GMM7328100 BS/SG-6		GMM7328100 BS/SG-7		GMM7328100 BS/SG-8		Unit	Note
		Min	Max	Min	Max	Min	Max		
tCSR	$\overline{\text{CAS}}$ Setup Time ($\overline{\text{CAS}}$ -before- $\overline{\text{RAS}}$ Refresh Cycle)	5	-	5	-	5	-	ns	
tCHR	$\overline{\text{CAS}}$ Hold Time ($\overline{\text{CAS}}$ -before- $\overline{\text{RAS}}$ Refresh Cycle)	10	-	10	-	10	-	ns	
tRPC	$\overline{\text{RAS}}$ Precharge to $\overline{\text{CAS}}$ Hold Time	0	-	0	-	0	-	ns	
tWRP	$\overline{\text{WE}}$ Set-up Time ($\overline{\text{CAS}}$ -before- $\overline{\text{RAS}}$ Refresh Cycle)	0	-	0	-	0	-	ns	
tWRH	$\overline{\text{WE}}$ Hold Time ($\overline{\text{CAS}}$ -before- $\overline{\text{RAS}}$ Refresh Cycle)	10	-	10	-	10	-	ns	

Fast Page Mode Cycle

Symbol	Parameter	GMM7328100 BS/SG-6		GMM7328100 BS/SG-7		GMM7328100 BS/SG-8		Unit	Note
		Min	Max	Min	Max	Min	Max		
tPC	Fast Page Mode Cycle Time	40	-	45	-	50	-	ns	
tCP	Fast Page Mode $\overline{\text{CAS}}$ Precharge Time	10	-	10	-	10	-	ns	
tRASP	Fast Page Mode $\overline{\text{RAS}}$ Pulse Width	-	100,000	-	100,000	-	100,000	ns	13
tACP	Access Time from $\overline{\text{CAS}}$ Precharge	-	35	-	40	-	45	ns	14
tRHCP	$\overline{\text{RAS}}$ Hold Time from $\overline{\text{CAS}}$ Precharge	35	-	40	-	45	-	ns	

Notes:

1. AC measurements assume $t_r = 5 \text{ ns}$.
2. Assumes that $t_{rCD} \leq t_{rCD(\text{max})}$ and $t_{rAD} \leq t_{rAD(\text{max})}$. If t_{rCD} or t_{rAD} is greater than the maximum recommended value shown in this table, t_{rAC} exceeds the value shown.
3. Measured with a load circuit equivalent to 2TTL loads and 100pF.
4. Assumes that $t_{rCD} \geq t_{rCD(\text{max})}$ and $t_{rAD} \leq t_{rAD(\text{max})}$.
5. Assumes that $t_{rCD} \leq t_{rCD(\text{max})}$ and $t_{rAD} \geq t_{rAD(\text{max})}$.
6. Either t_{rCH} or t_{rRH} must be satisfied for a read cycles.
7. $t_{\text{OFF}(\text{max})}$ defines the time at which the outputs achieve the open circuit condition and is not referenced to output voltage levels.
8. $V_{IH(\text{min})}$ and $V_{IL(\text{max})}$ are reference levels for measuring timing of input signals. Also, transition times are measured between V_{IH} and V_{IL} .
9. Operation with the $t_{rCD(\text{max})}$ limit insures that $t_{rAC(\text{max})}$ can be met, $t_{rCD(\text{max})}$ is specified as a reference point only, if t_{rCD} is greater than the specified $t_{rCD(\text{max})}$ limit, then access time is controlled exclusively by t_{CAC} .
10. Operation with the $t_{rAD(\text{max})}$ limit insures that $t_{rAC(\text{max})}$ can be met, $t_{rAD(\text{max})}$ is specified as a reference point only, if t_{rAD} is greater than the specified $t_{rAD(\text{max})}$ limit, then access time is controlled exclusively by t_{AA} .
11. t_{wCS} is not restrictive operating parameter. It is included in the data sheet as electrical characteristics only. If $t_{wCS} \geq t_{wCS(\text{min})}$, the cycle is an early write cycle and the data out pin will remain open circuit (high impedance) throughout the entire cycle.
12. These parameters are referenced to $\overline{\text{CAS}}$ leading edge in early write cycles.
13. t_{RASP} is defines $\overline{\text{RAS}}$ pulse width in Fast Page Mode cycles.
14. Access time is determined by the longer of t_{AA} or t_{CAC} or t_{ACP} .
15. An initial pause of 200 μs is required after power up followed by a minimum of eight initialization cycles (any combination of cycles containing $\overline{\text{RAS}}$ clock such as $\overline{\text{RAS}}$ only refresh). If the internal refresh counter is used, a minimum of eight $\overline{\text{CAS}}$ before $\overline{\text{RAS}}$ refresh cycles are required.

Timing Waveforms

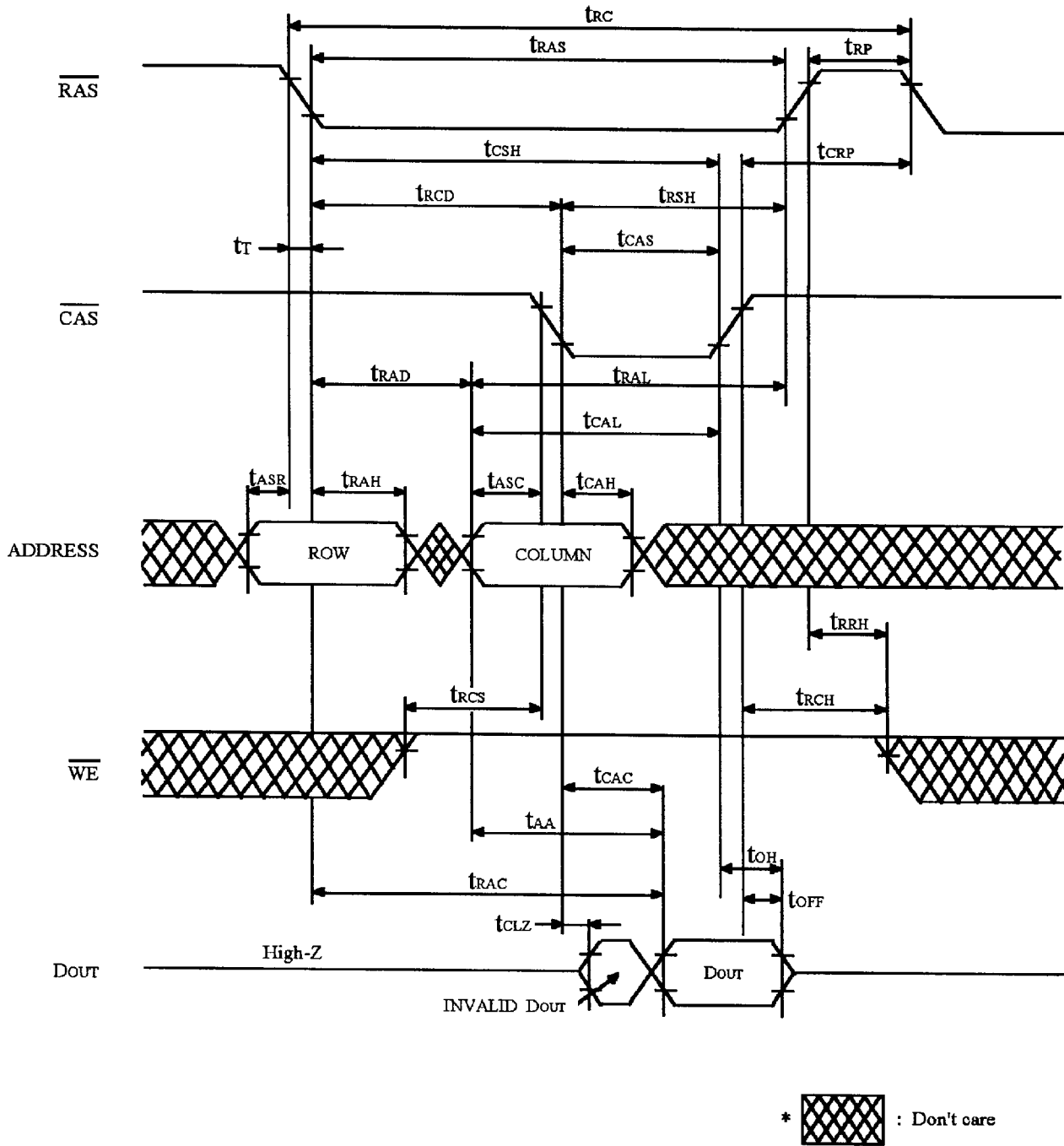
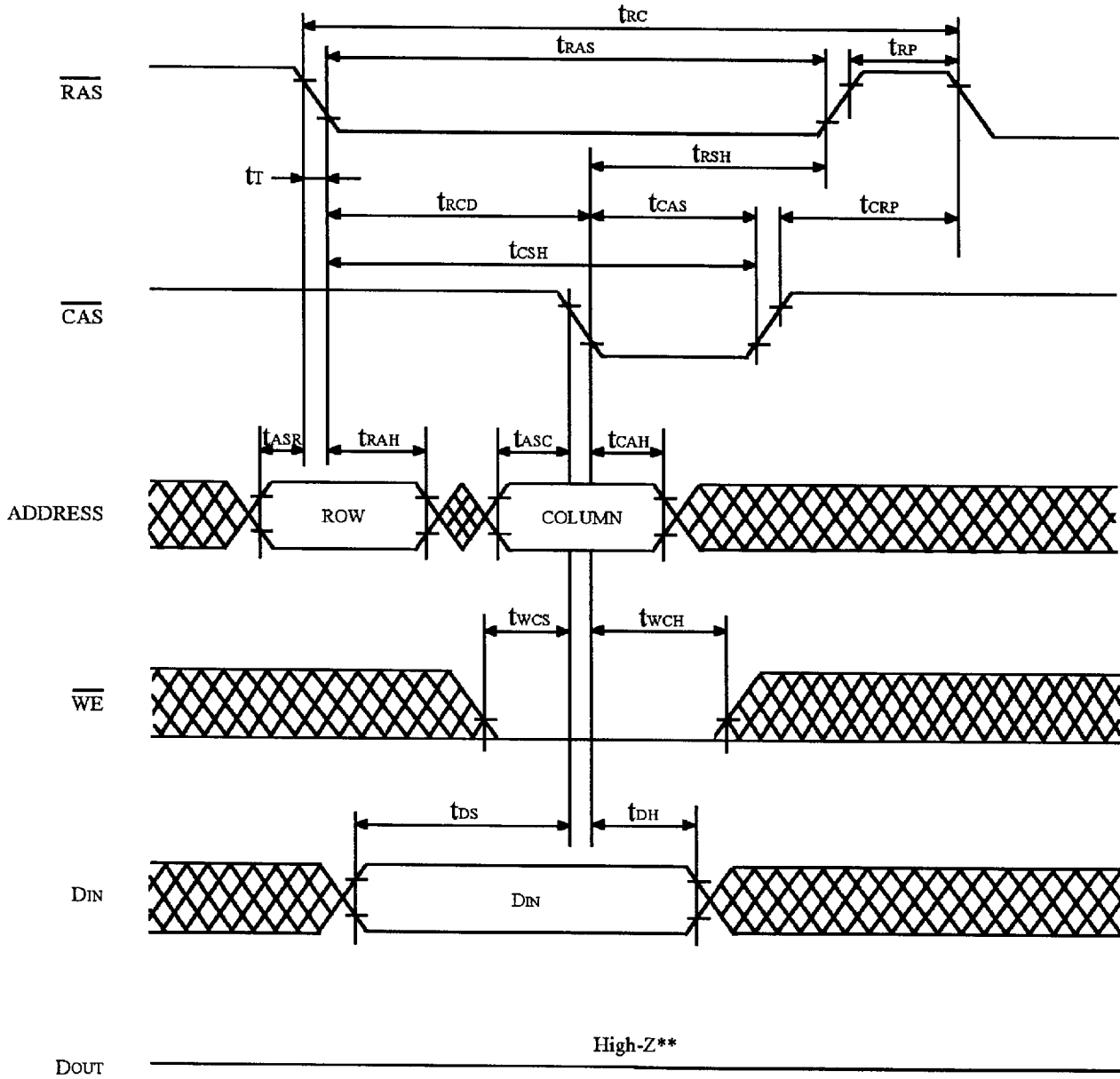



FIGURE 1. READ CYCLE



*  : Don't care

** $t_{wcs} \geq t_{wcs}(\text{min})$

FIGURE 2. EARLY WRITE CYCLE

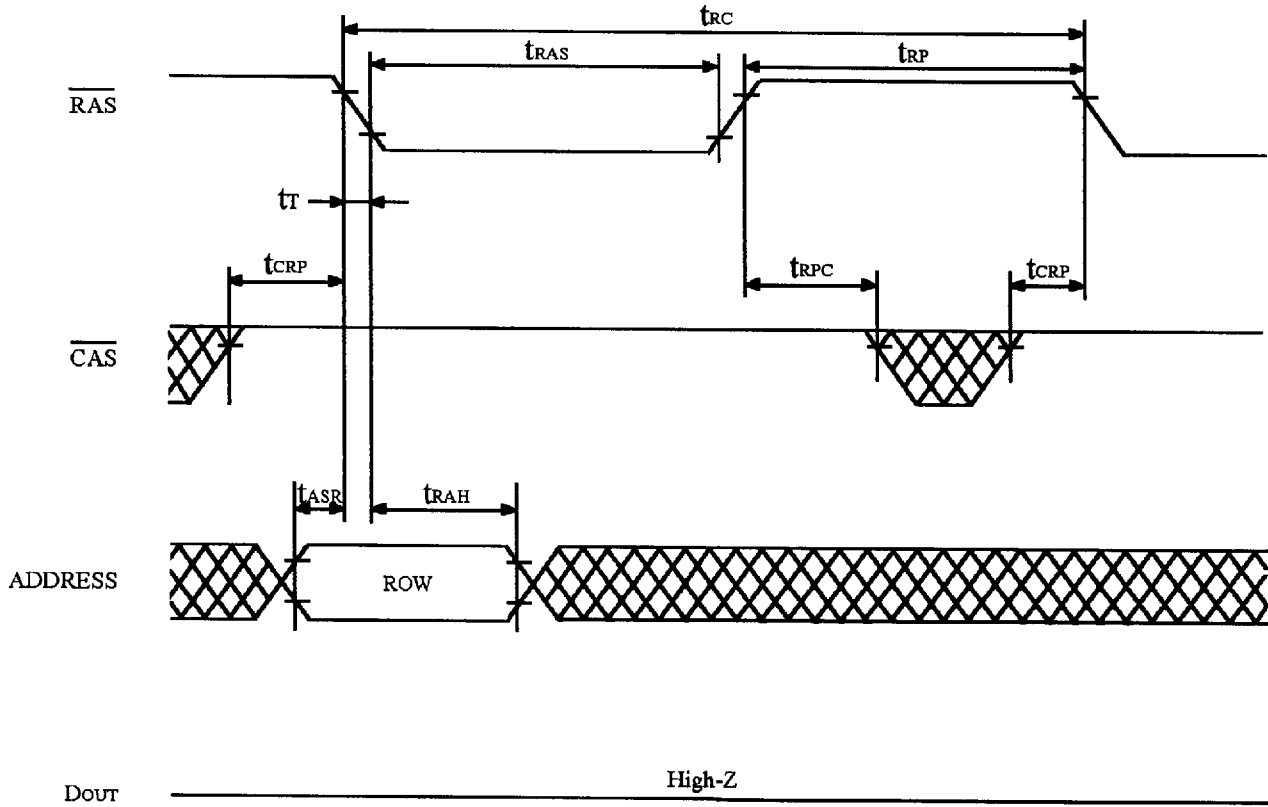

*  : Don't care

** $\overline{\text{WE}}$: Don't care

FIGURE 3. $\overline{\text{RAS}}$ ONLY REFRESH CYCLE

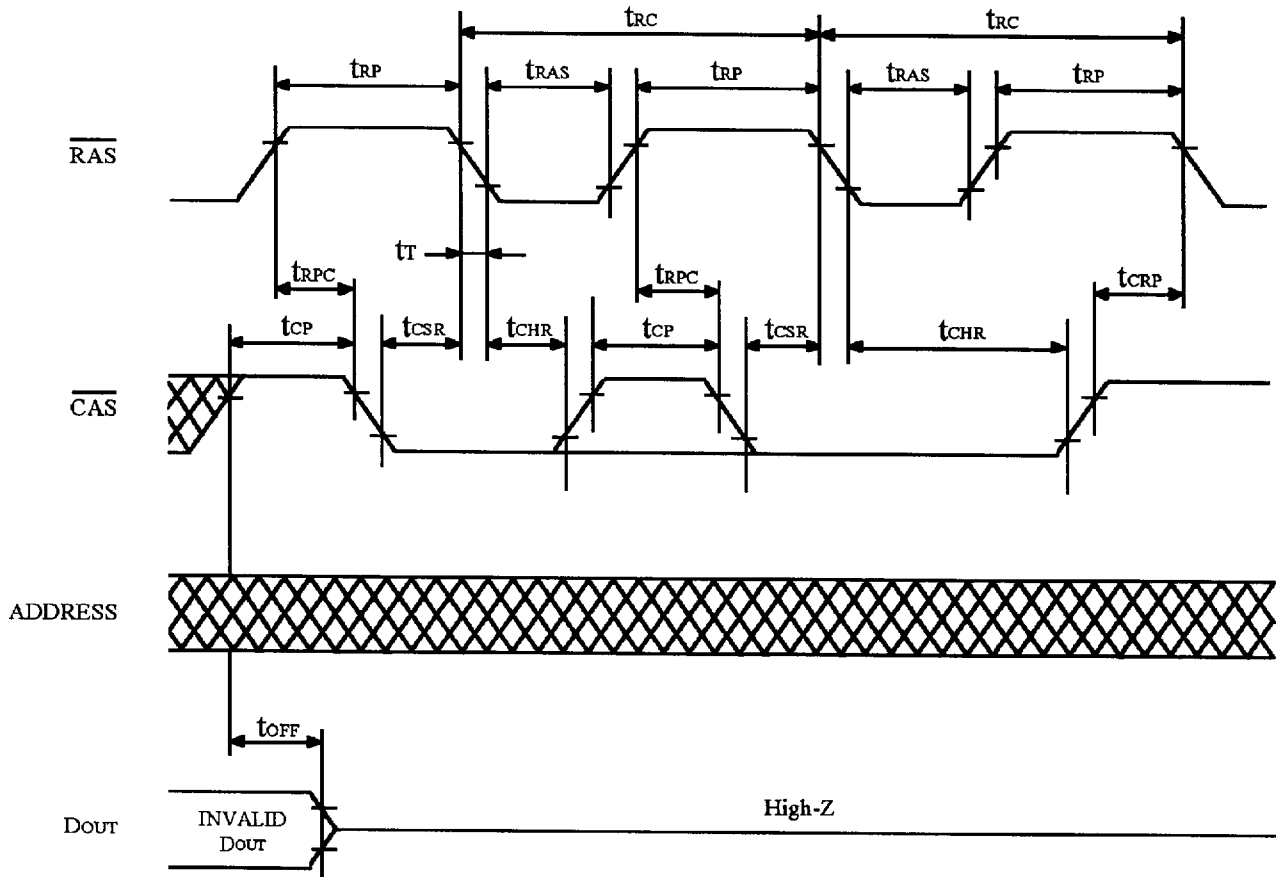

*  : Don't care

** $\overline{WE} : V_{IH}$

FIGURE 4. \overline{CAS} BEFORE \overline{RAS} REFRESH CYCLE

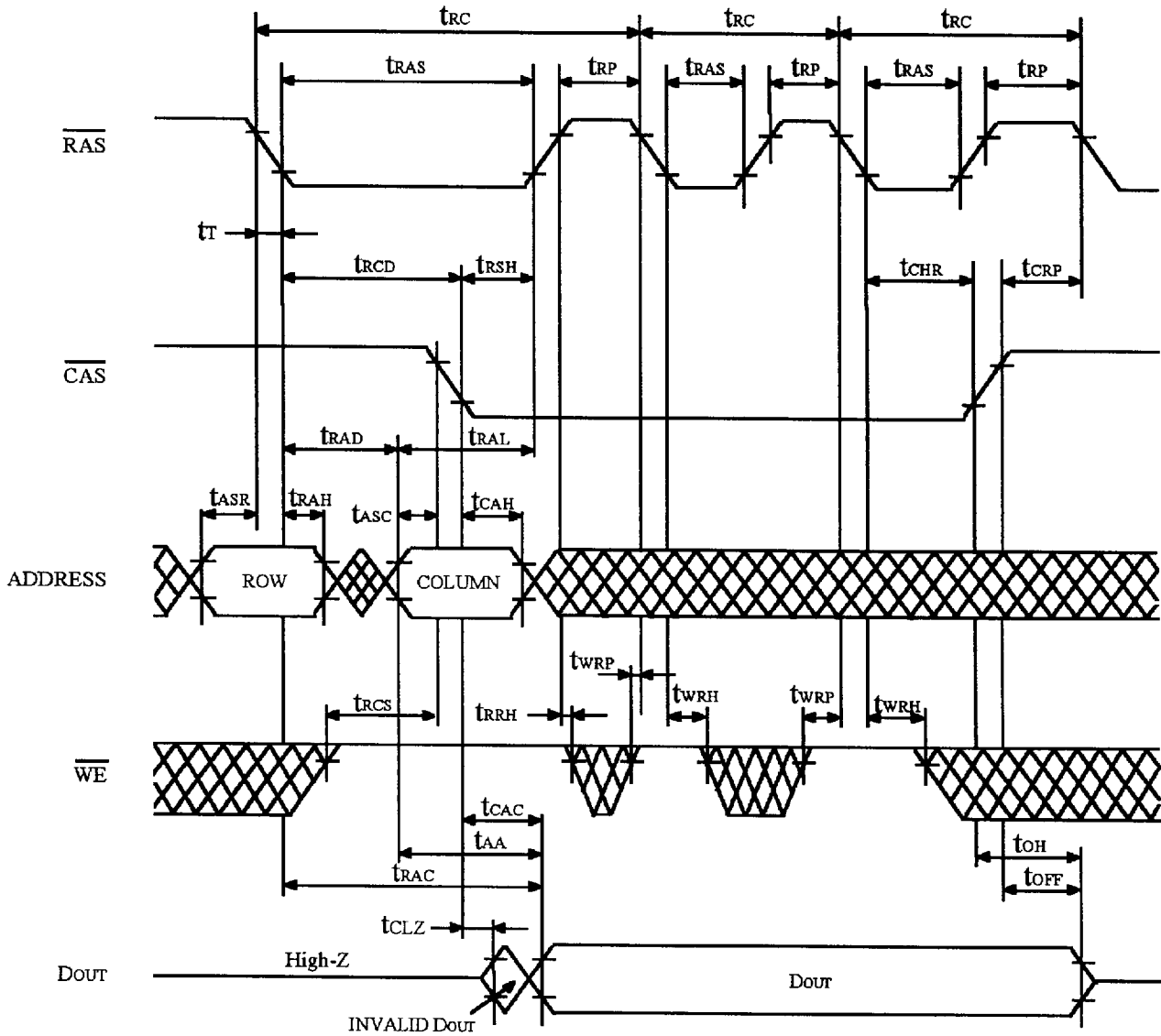

*  : Don't care

FIGURE 5. HIDDEN REFRESH CYCLE

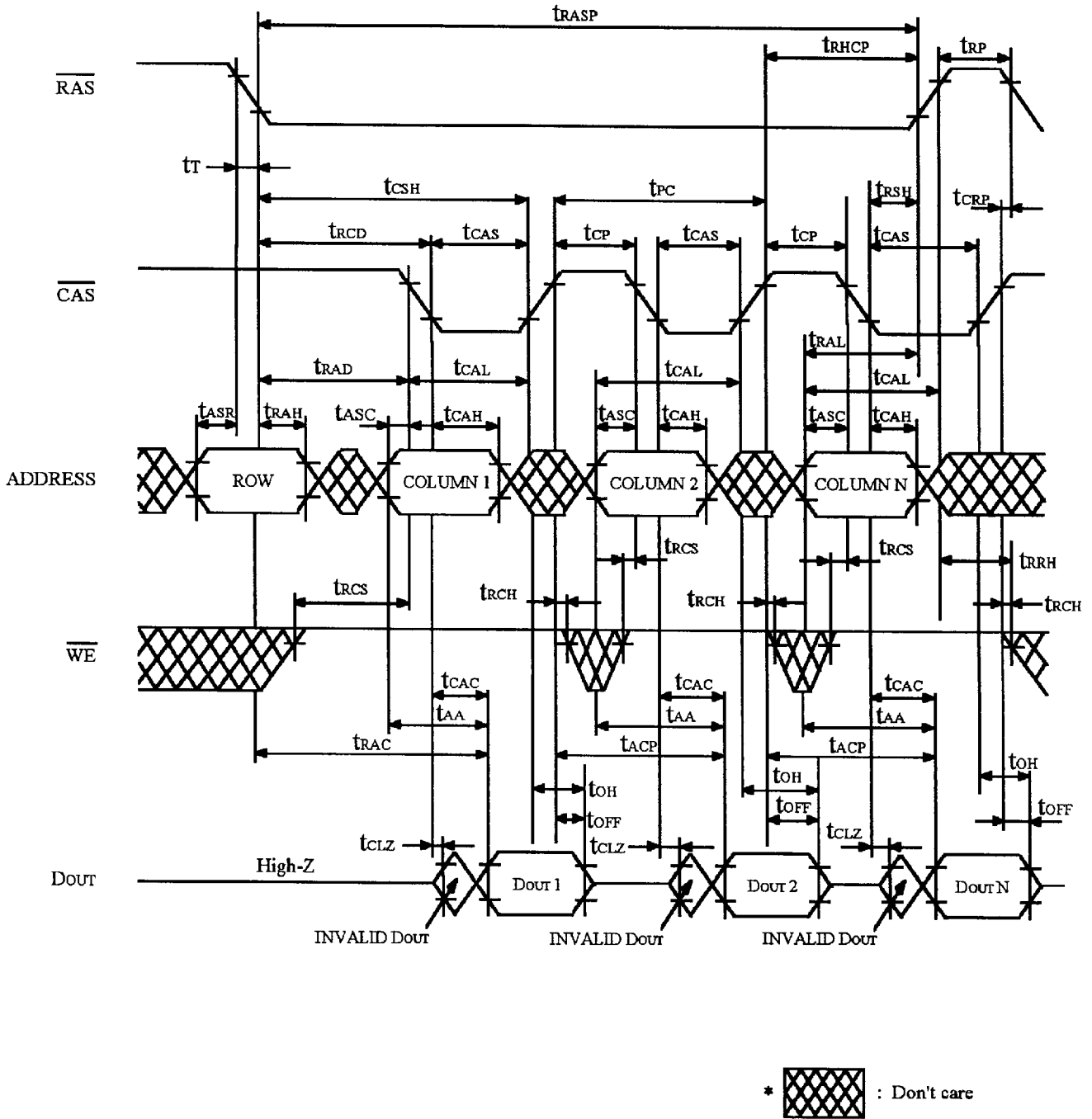

FIGURE 6. FAST PAGE MODE READ CYCLE

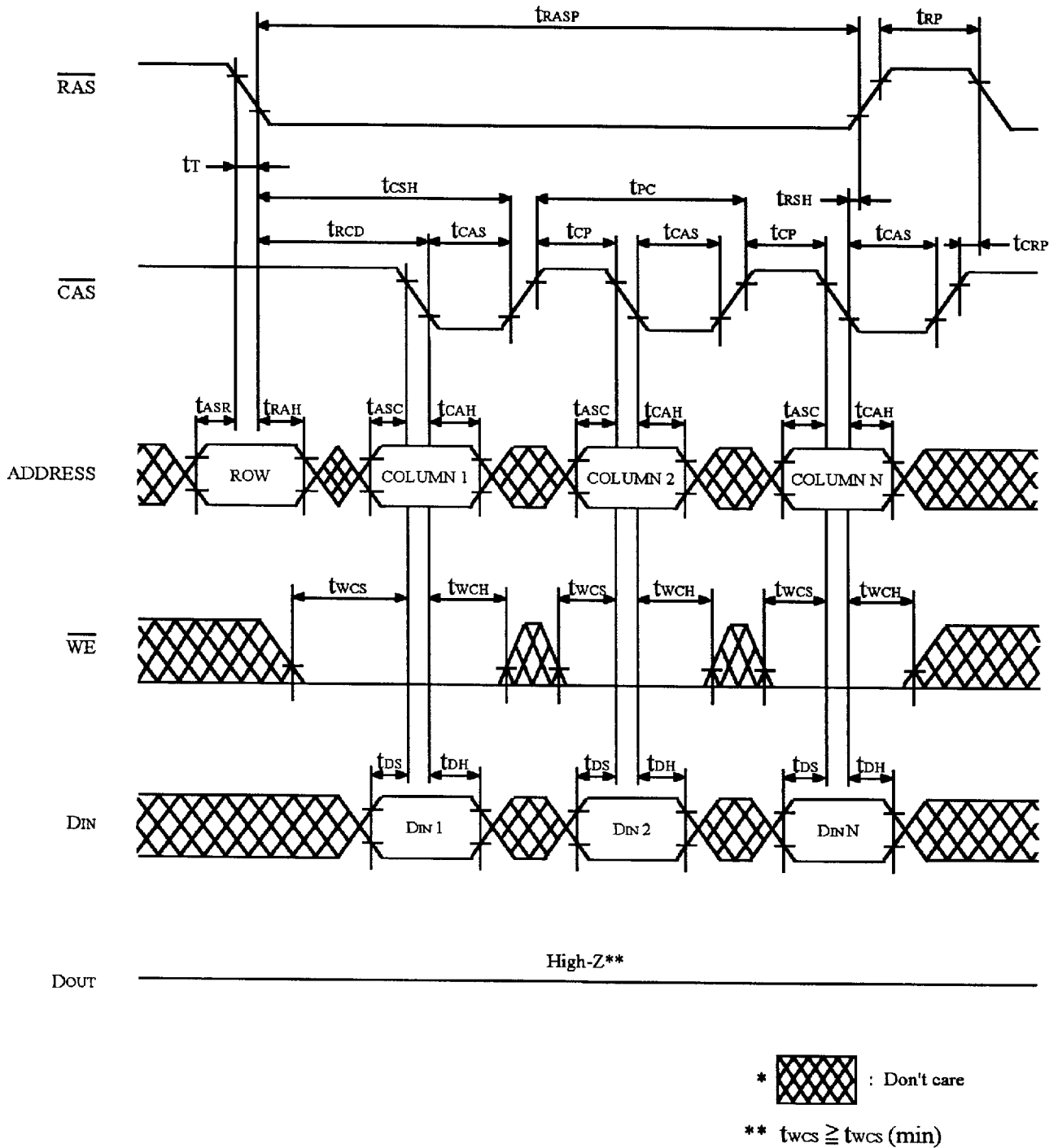
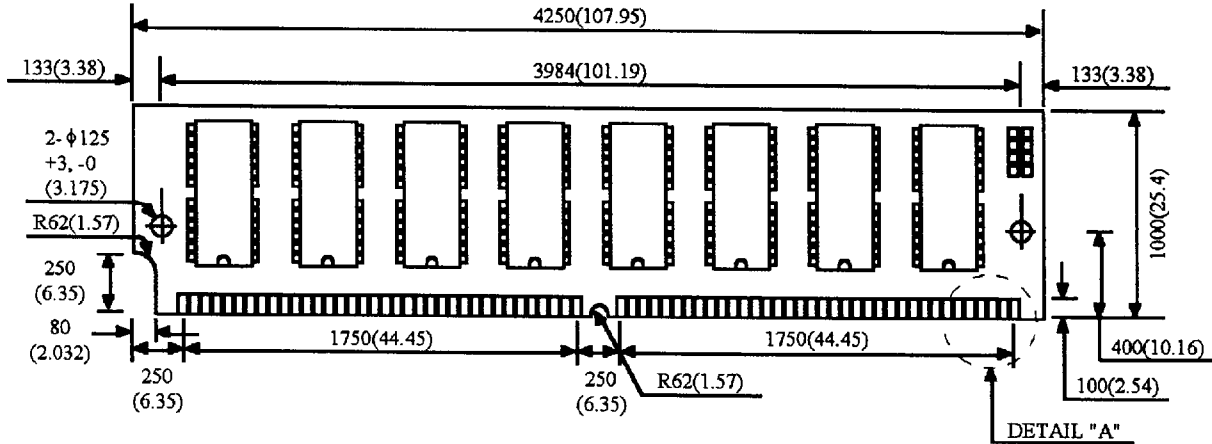

FIGURE 7. FAST PAGE MODE EARLY WRITE CYCLE

Package Dimension

Unit: mil (mm)
 * (1mil = 1/1000 inches)

FRONT



REAR

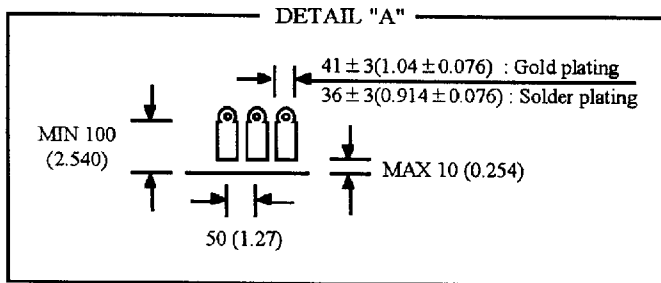
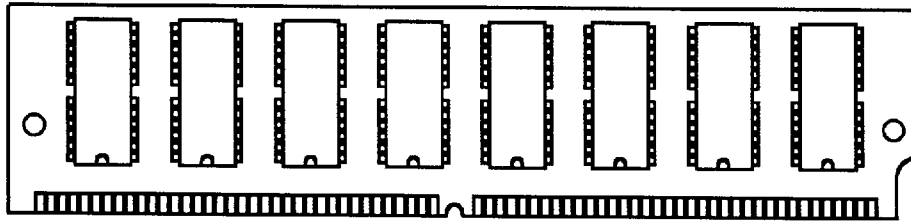

Tolerances : $\pm 5(0.127)$ unless otherwise specified.

