

Features

- Epitaxial Planar Die Construction
- Complementary NPN Type Available (MMBT2222AT)
- Ultra-Small Surface Mount Package
- Also Available in Lead Free Version

Mechanical Data

- Case: SOT-523, Molded Plastic
- Case material - UL Flammability Rating 94V-0
- Moisture sensitivity: Level 1 per J-STD-020A
- Terminals: Solderable per MIL-STD-202, Method 208
- Also Available in Lead Free Plating (Matte Tin Finish). Please See Ordering Information, Note 4, on Page 2
- Terminal Connections: See Diagram
- Marking (See Page 2): 2F
- Ordering & Date Code Information, See Page 2

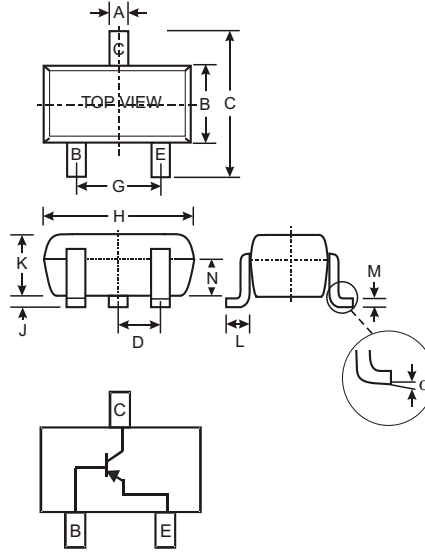

SOT-523			
Dim	Min	Max	Typ
A	0.15	0.30	0.22
B	0.75	0.85	0.80
C	1.45	1.75	1.60
D	—	—	0.50
G	0.90	1.10	1.00
H	1.50	1.70	1.60
J	0.00	0.10	0.05
K	0.60	0.80	0.75
L	0.10	0.30	0.22
M	0.10	0.20	0.12
N	0.45	0.65	0.50
α	0°	8°	—
All Dimensions in mm			

Maximum Ratings @ $T_A = 25^\circ\text{C}$ unless otherwise specified

Characteristic	Symbol	Value	Unit
Collector-Base Voltage	V_{CBO}	-60	V
Collector-Emitter Voltage	V_{CEO}	-60	V
Emitter-Base Voltage	V_{EBO}	-5.0	V
Collector Current - Continuous	I_C	-600	mA
Power Dissipation (Note 1)	P_d	150	mW
Thermal Resistance, Junction to Ambient (Note 1)	$R_{\theta JA}$	833	$^\circ\text{C/W}$
Operating and Storage and Temperature Range	T_j, T_{STG}	-55 to +150	$^\circ\text{C}$

Notes: 1. Device mounted on FR-4 PCB, 1 inch x 0.85 inch x 0.062 inch; pad layout as shown on Diodes Inc. suggested pad layout document AP02001, which can be found on our website at <http://www.diodes.com/datasheets/ap02001.pdf>.

Electrical Characteristics @ $T_A = 25^\circ\text{C}$ unless otherwise specified

Characteristic	Symbol	Min	Max	Unit	Test Condition
OFF CHARACTERISTICS (Note 2)					
Collector-Base Breakdown Voltage	$V_{(BR)CBO}$	-60	—	V	$I_C = -10\mu\text{A}, I_E = 0$
Collector-Emitter Breakdown Voltage	$V_{(BR)CEO}$	-60	—	V	$I_C = -10\text{mA}, I_B = 0$
Emitter-Base Breakdown Voltage	$V_{(BR)EBO}$	-5.0	—	V	$I_E = -10\mu\text{A}, I_C = 0$
Collector Cutoff Current	I_{CBO}	—	-10	nA μA	$V_{CB} = -50\text{V}, I_E = 0$ $V_{CB} = -50\text{V}, I_E = 0, T_A = 125^\circ\text{C}$
Collector Cutoff Current	I_{CEX}	—	-50	nA	$V_{CE} = -30\text{V}, V_{EB(OFF)} = -0.5\text{V}$
Base Cutoff Current	I_{BL}	—	-50	nA	$V_{CE} = -30\text{V}, V_{EB(OFF)} = -0.5\text{V}$
ON CHARACTERISTICS (Note 2)					
DC Current Gain	h_{FE}	75 100 100 100 50	— — — 300 —	—	$I_C = -100\mu\text{A}, V_{CE} = -10\text{V}$ $I_C = -1.0\text{mA}, V_{CE} = -10\text{V}$ $I_C = -10\text{mA}, V_{CE} = -10\text{V}$ $I_C = -150\text{mA}, V_{CE} = -10\text{V}$ $I_C = -500\text{mA}, V_{CE} = -10\text{V}$
Collector-Emitter Saturation Voltage	$V_{CE(SAT)}$	—	-0.4 -1.6	V	$I_C = -150\text{mA}, I_B = -15\text{mA}$ $I_C = -500\text{mA}, I_B = -50\text{mA}$
Base-Emitter Saturation Voltage	$V_{BE(SAT)}$	—	-1.3 -2.6	V	$I_C = 150\text{mA}, I_B = 15\text{mA}$ $I_C = 500\text{mA}, I_B = 50\text{mA}$
SMALL SIGNAL CHARACTERISTICS					
Output Capacitance	C_{obo}	—	8.0	pF	$V_{CB} = -10\text{V}, f = 1.0\text{MHz}, I_E = 0$
Input Capacitance	C_{ibo}	—	30	pF	$V_{EB} = -2.0\text{V}, f = 1.0\text{MHz}, I_C = 0$
Current Gain-Bandwidth Product	f_T	200	—	MHz	$V_{CE} = -20\text{V}, I_C = -50\text{mA}, f = 100\text{MHz}$
SWITCHING CHARACTERISTICS					
Turn-On Time	t_{off}	—	45	ns	
Delay Time	t_d	—	10	ns	$V_{CC} = -30\text{V}, I_C = -150\text{mA}, I_{B1} = -15\text{mA}$
Rise Time	t_r	—	40	ns	
Turn-Off Time	t_{off}	—	100	ns	
Storage Time	t_s	—	80	ns	$V_{CC} = -6.0\text{V}, I_C = -150\text{mA}, I_{B1} = I_{B2} = -15\text{mA}$
Fall Time	t_f	—	30	ns	

Ordering Information (Note 3 & 4)

Device	Packaging	Shipping
MMBT2907AT-7	SOT-523	3000/Tape & Reel

- Notes:
- Short duration test pulse used to minimize self-heating effect.
 - For Packaging Details, go to our website at <http://www.diodes.com/datasheets/ap02007.pdf>.
 - For lead free terminal plating part number, please add "-F" suffix to part number above. Example: MMBT2907AT-7-F.

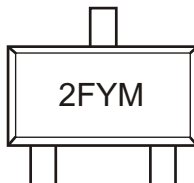
Marking Information

2F = Product Type Marking Code
 YM = Date Code Marking
 Y = Year (ex: N = 2002)
 M = Month (ex: 9 = September)

Date Code Key

Year	1998	1999	2000	2001	2002	2003	2004
Code	J	K	L	M	N	P	R

Month	Jan	Feb	March	Apr	May	Jun	Jul	Aug	Sep	Oct	Nov	Dec
Code	1	2	3	4	5	6	7	8	9	O	N	D

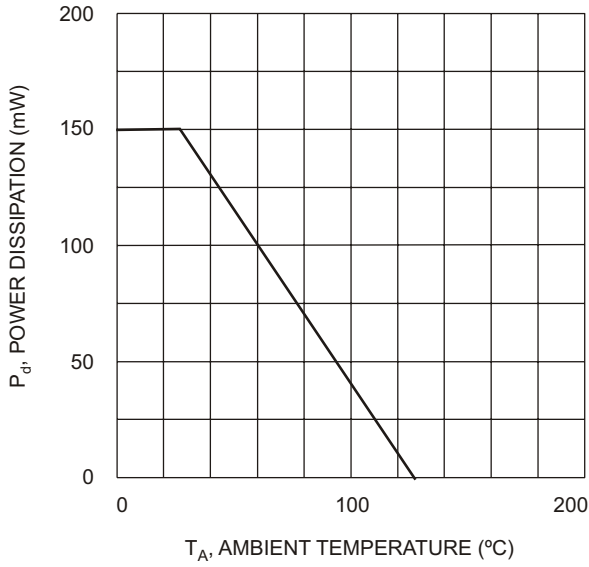

T_A , AMBIENT TEMPERATURE (°C)
Fig. 1 Power Derating Curve, Total Package

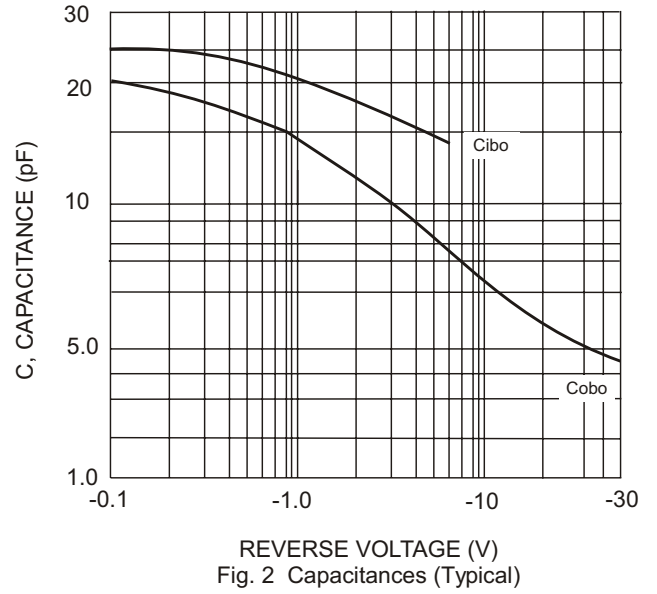

REVERSE VOLTAGE (V)
Fig. 2 Capacitances (Typical)

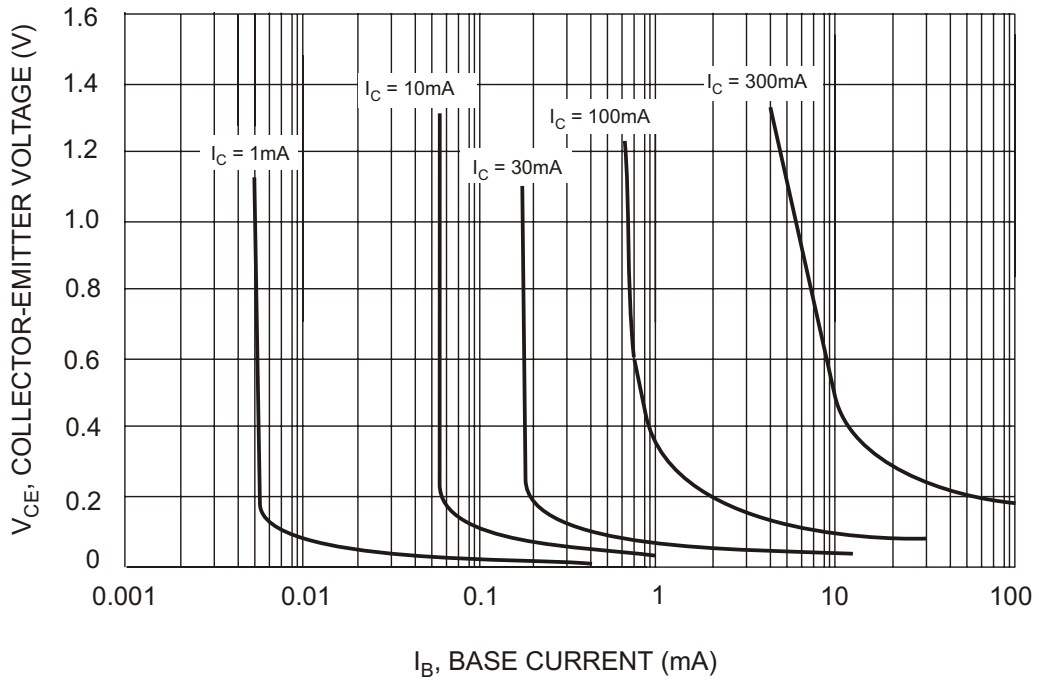

I_B , BASE CURRENT (mA)
Fig. 3 Typical Collector Saturation Region

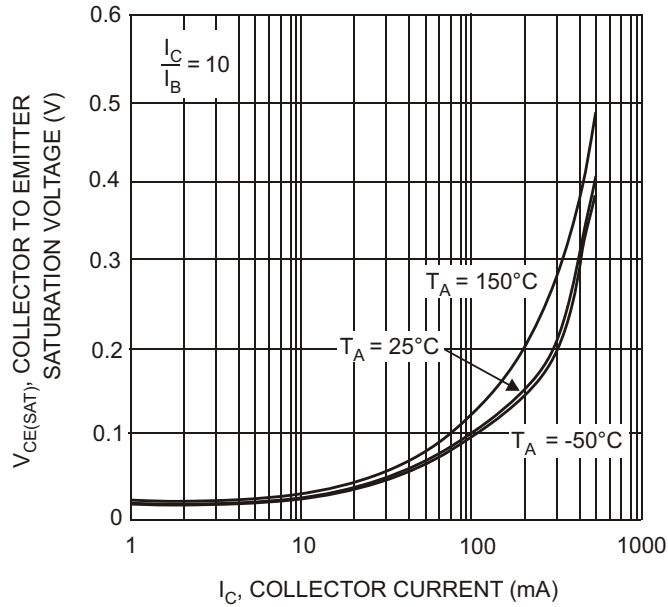

Fig. 4, Collector Emitter Saturation Voltage vs. Collector Current

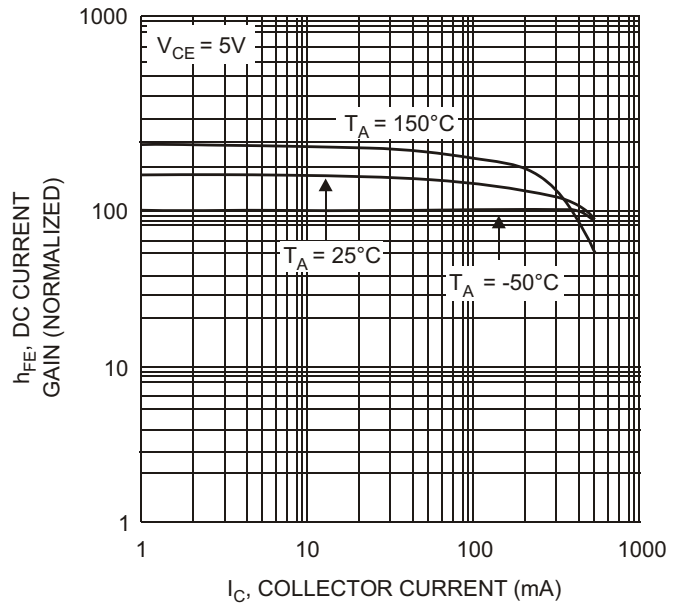

Fig. 5, DC Current Gain vs. Collector Current

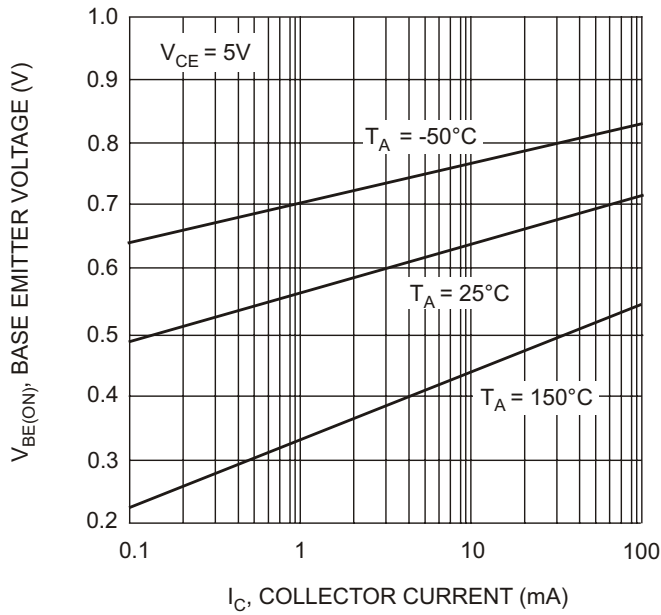

Fig. 6, Base Emitter Voltage vs. Collector Current

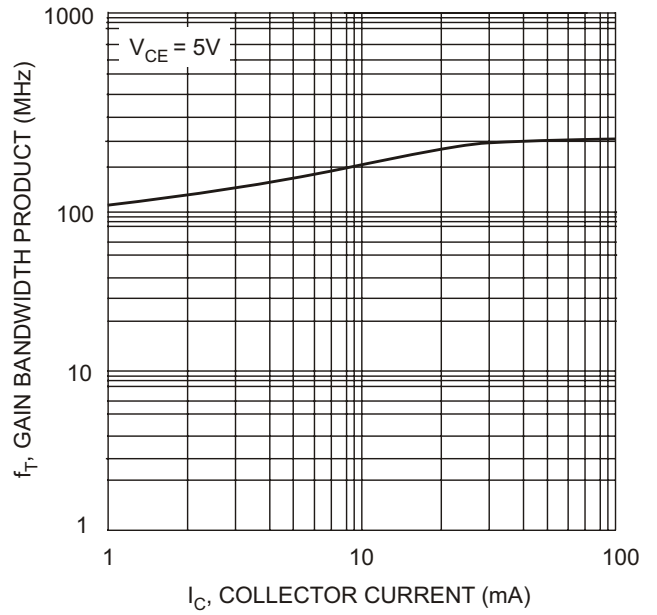

Fig. 7, Gain Bandwidth Product vs. Collector Current