

Optocoupler, Phototransistor Output (Single, Dual, Quad Channel)

Features

- IL74/ ILD74/ ILQ74 TTL Compatible
- Transfer Ratio, 35 % Typical
- Coupling Capacitance, 0.5 pF
- Single, Dual, & Quad Channel
- Industry Standard DIP Package

Agency Approvals

- UL - File No. E52744 System Code H or J
- CSA 93751
- BSI IEC60950 IEC60965
- DIN EN 60747-5-2(VDE0884)
DIN EN 60747-5-5 pending
Available with Option 1, X001 Suffix
- FIMKO

Description

The IL74/ ILD74/ ILQ74 is an optically coupled pair with a GaAlAs infrared LED and a silicon NPN phototransistor. Signal information, including a DC level, can be transmitted by the device while maintaining a high degree of electrical isolation between input and output. The IL74/ ILD74/ ILQ74 is especially for driving medium-speed logic, where it may be used to elimi-

nate troublesome ground loop and noise problems. Also it can be used to replace relays and transformers in many digital interface applications, as well as analog applications such as CTR modulation.

The ILD74 has two isolated channels in a single DIP package; the ILQ74 has four isolated channels per package.

Single Channel

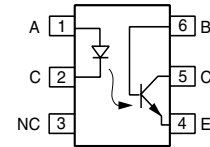
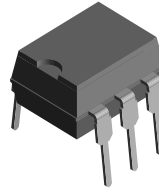

Dual Channel

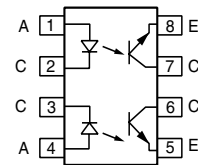
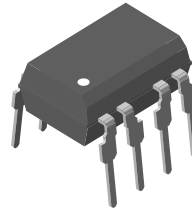

Quad Channel

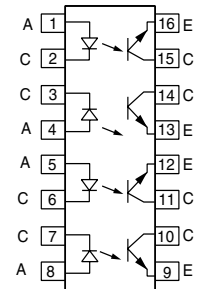
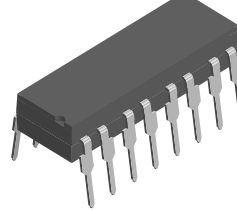

Order Information

Part	Remarks
IL74	CTR _{DC} 35 %, Single Channel DIP-6
ILD74	CTR _{DC} 35 %, Dual Channel DIP-8
ILQ74	CTR _{DC} 35 %, Quad Channel DIP-16
IL74-X006	CTR _{DC} 35 %, Single Channel DIP-6 400 mil (option 6)
ILD74-X006	CTR _{DC} 35 %, Dual Channel DIP-8 400 mil (option 6)
ILD74-X007	CTR _{DC} 35 %, Dual Channel SMD-8 (option 7)
ILD74-X009	CTR _{DC} 35 %, Dual Channel SMD-8 (option 9)
ILQ74-X009	CTR _{DC} 35 %, Quad Channel SMD-16 (option 9)

For additional information on the available options refer to Option Information.

Absolute Maximum Ratings

$T_{amb} = 25\text{ }^{\circ}\text{C}$, unless otherwise specified

Stresses in excess of the absolute Maximum Ratings can cause permanent damage to the device. Functional operation of the device is not implied at these or any other conditions in excess of those given in the operational sections of this document. Exposure to absolute Maximum Rating for extended periods of the time can adversely affect reliability.

Input

(each channel)

Parameter	Test condition	Symbol	Value	Unit
Peak reverse voltage		V_R	3.0	V
Forward continuous current		I_F	60	mA
Power dissipation		P_{diss}	100	mW
Derate linearly from 55 %			1.33	mW/ $^{\circ}\text{C}$

Output

Parameter	Test condition	Symbol	Value	Unit
Collector-emitter breakdown voltage		BV_{CEO}	20	V
Emitter-collector breakdown voltage		BV_{ECO}	5.0	V
Collector-base breakdown voltage		BV_{CBO}	70	V
Power dissipation		P_{diss}	150	mW
Derate linearly from 25 $^{\circ}\text{C}$			2.0	mW/ $^{\circ}\text{C}$

Coupler

Parameter	Test condition	Part	Symbol	Value	Unit
Isolation test voltage	$t = 1.0\text{ sec.}$		V_{ISO}	5300	V_{RMS}
Isolation resistance	$V_{IO} = 500\text{ V, } T_A = 25\text{ }^{\circ}\text{C}$		R_{IO}	$\geq 10^{12}$	Ω
	$V_{IO} = 500\text{ V, } T_A = 100\text{ }^{\circ}\text{C}$		R_{IO}	$\geq 10^{11}$	Ω
Total package dissipation		IL74	P_{tot}	200	mW
		ILD74	P_{tot}	400	mW
		ILQ74	P_{tot}	500	mW
Derate linearly from 25 $^{\circ}\text{C}$		IL74		2.7	mW/ $^{\circ}\text{C}$
		ILD74		5.33	mW/ $^{\circ}\text{C}$
		ILQ74		6.67	mW/ $^{\circ}\text{C}$
Creepage				≥ 7.0	mm
Clearance				≥ 7.0	mm
Storage temperature			T_{stg}	- 55 to + 150	$^{\circ}\text{C}$
Operating temperature			T_{amb}	- 55 to + 100	$^{\circ}\text{C}$
Lead soldering time at 260 $^{\circ}\text{C}$				10	sec.



Electrical Characteristics

$T_{amb} = 25\text{ }^{\circ}\text{C}$, unless otherwise specified

Minimum and maximum values are testing requirements. Typical values are characteristics of the device and are the result of engineering evaluation. Typical values are for information only and are not part of the testing requirements.

Input

Parameter	Test condition	Symbol	Min	Typ.	Max	Unit
Forward voltage	$I_F = 20\text{ mA}$	V_F		1.3	1.5	V
Reverse current	$V_R = 3.0\text{ V}$	I_R		0.1	100	μA
Capacitance	$V_R = 0\text{ V}$	C_O		25		pF

Output

Parameter	Test condition	Symbol	Min	Typ.	Max	Unit
Collector-emitter breakdown voltage	$I_C = 1.0\text{ mA}$	BV_{CEO}	20	50		V
Collector-emitter leakage current	$V_{CE} = 5.0\text{ V}$, $I_F = 0$	I_{CEO}		5.0	500	nA
Collector-emitter capacitance	$V_{CE} = 0$, $f = 1.0\text{ MHz}$	C_{CE}		10.0		pF

Coupler

Parameter	Test condition	Symbol	Min	Typ.	Max	Unit
Saturation voltage collector-emitter	$I_C = 2.0\text{ mA}$, $I_F = 16\text{ mA}$	V_{CEsat}		0.3	0.5	V
Resistance, input to output		R_{IO}		100		$\text{G}\Omega$
Capacitance (input-output)		C_{IO}		0.5		pF

Current Transfer Ratio

Parameter	Test condition	Symbol	Min	Typ.	Max	Unit
DC Current Transfer Ratio	$I_F = 16\text{ mA}$, $V_{CE} = 5.0\text{ V}$	CTR_{DC}	12.5	35		%

Switching Characteristics

Parameter	Test condition	Symbol	Min	Typ.	Max	Unit
Switching times	$R_L = 100 \Omega$, $V_{CE} = 10 \text{ V}$, $I_C = 2.0 \text{ mA}$	t_{on} , t_{off}		3.0		μs

Typical Characteristics ($T_{amb} = 25^\circ\text{C}$ unless otherwise specified)

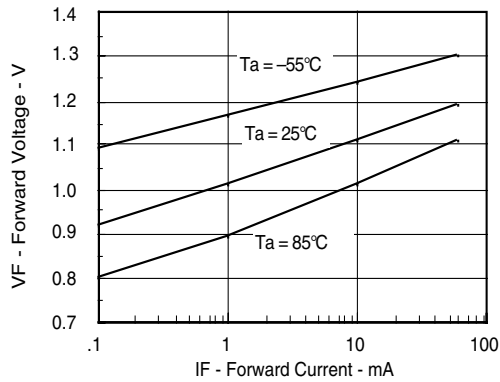

#74_01

Fig. 1 Forward Voltage vs. Forward Current

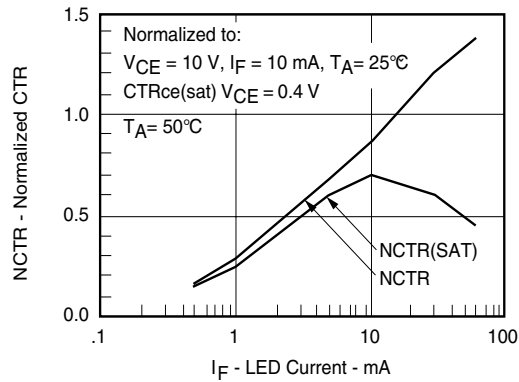

#74_03

Fig. 3 Normalized Non-Saturated and Saturated CTR vs. LED Current

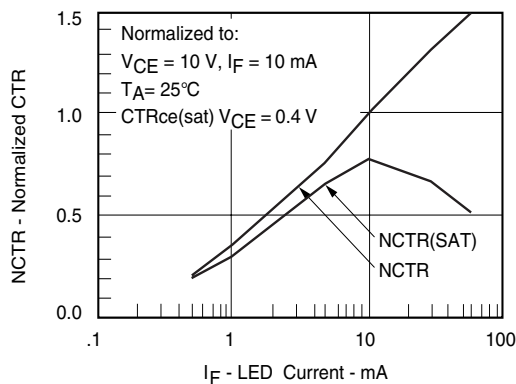

#74_02

Fig. 2 Normalized Non-Saturated and Saturated CTR vs. LED Current

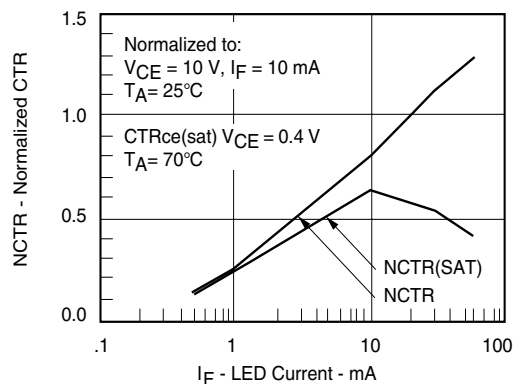

#74_04

Fig. 4 Normalized Non-Saturated and Saturated CTR vs. LED Current

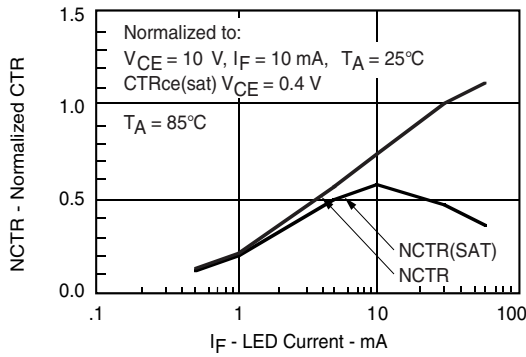

#74_05

Fig. 5 Normalized Non-Saturated and Saturated CTR vs. LED Current

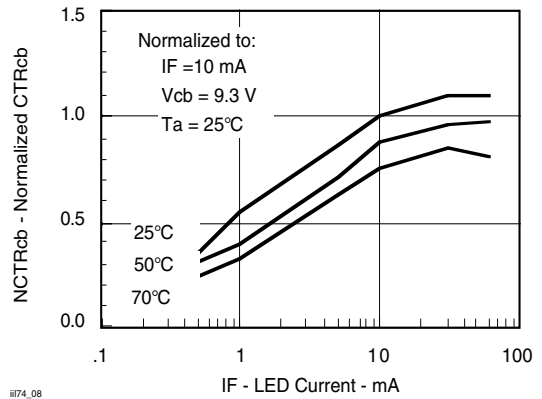

#74_08

Fig. 8 Normalized CTRcb vs. LED Current and Temp.

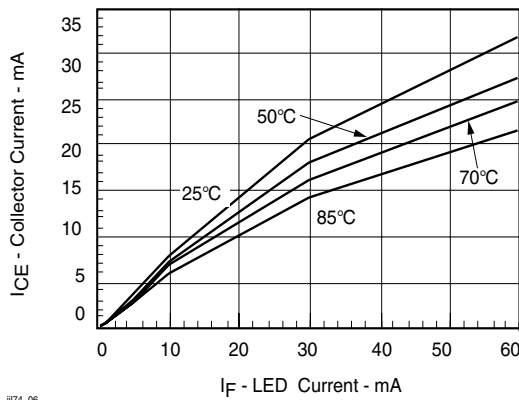

#74_06

Fig. 6 Collector-Emitter Current vs. Temperature and LED Current

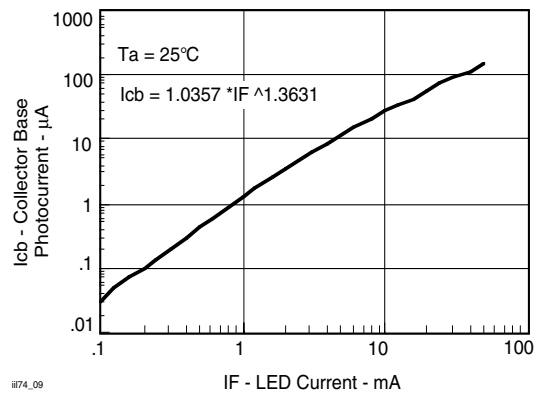

#74_09

Fig. 9 Collector Base Photocurrent vs. LED Current

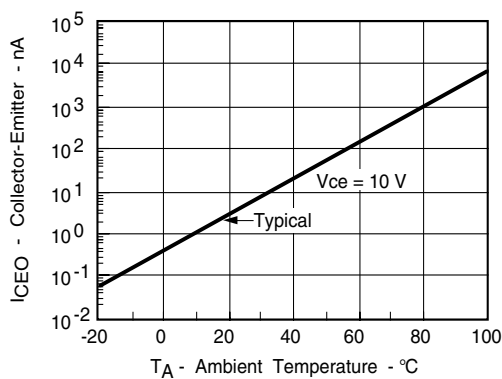

#74_07

Fig. 7 Collector-Emitter Leakage Current vs. Temp.

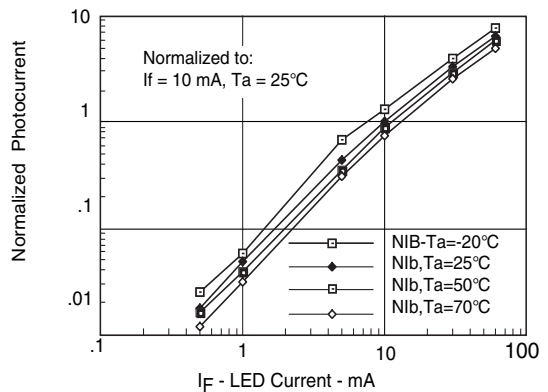

#74_10

Fig. 10 Normalized Photocurrent vs. I_F and Temp.

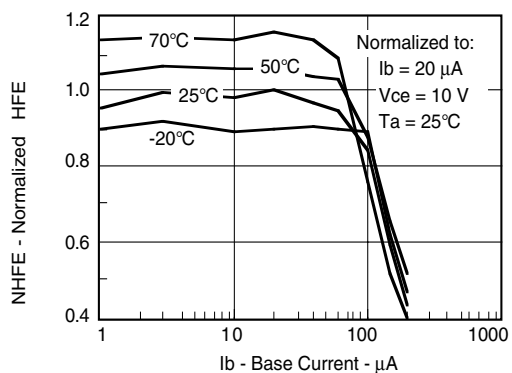

#74_11

Fig. 11 Normalized Non-saturated HFE vs. Base Current and Temperature

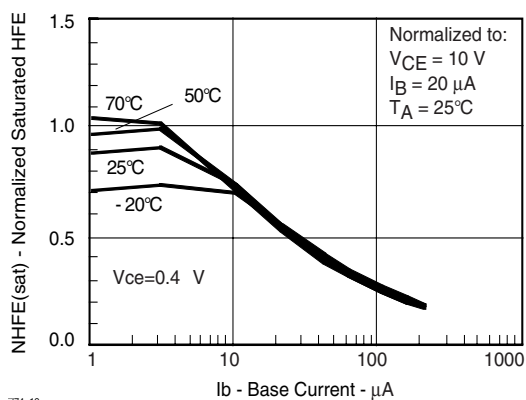

#74_12

Fig. 12 Normalized Saturated HFE vs. Base Current and Temperature

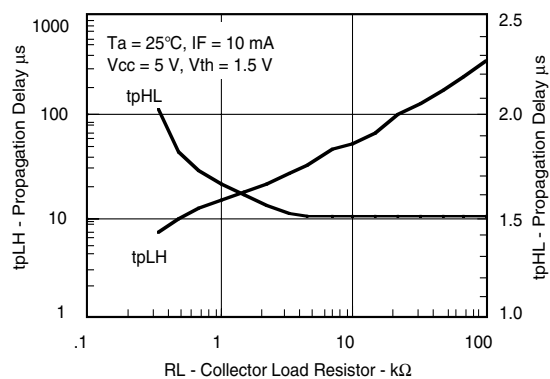

#74_13

Fig. 13 Propagation Delay vs. Collector Load Resistor

Package Dimensions in mm

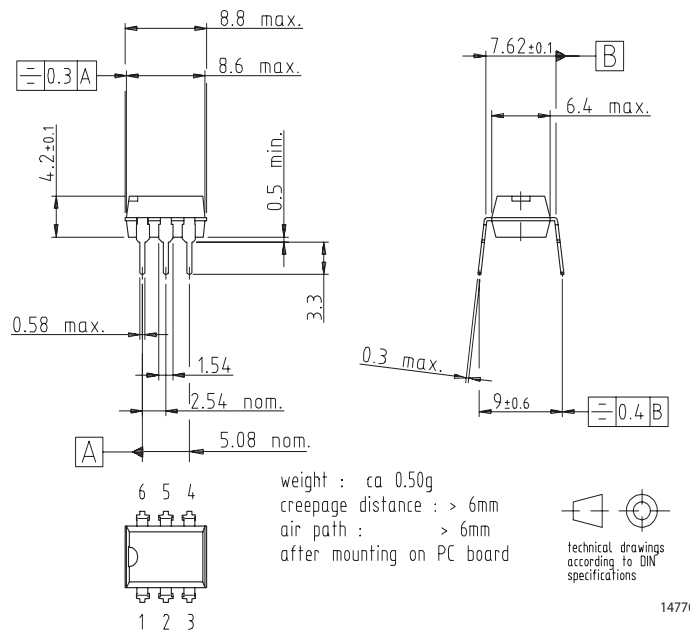

Package Dimensions in Inches (mm)

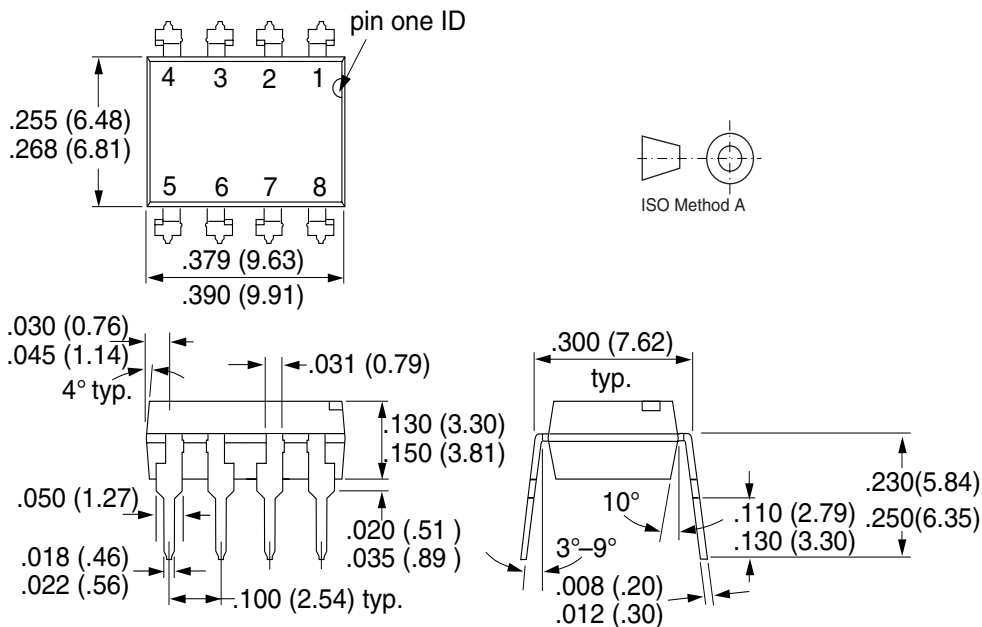

IL74/ ILD74/ ILQ74



Vishay Semiconductors

Package Dimensions in Inches (mm)

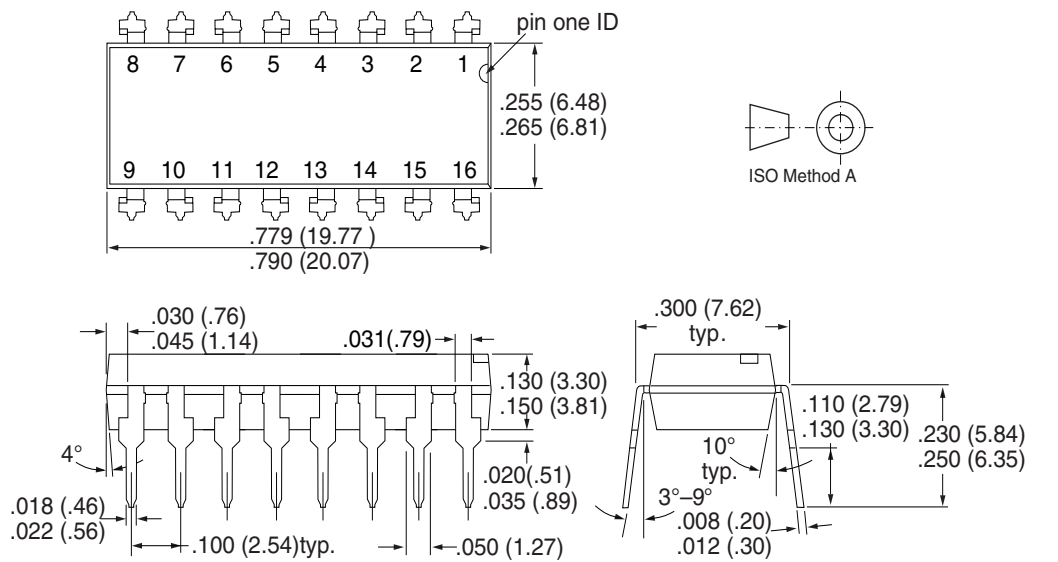

i178007

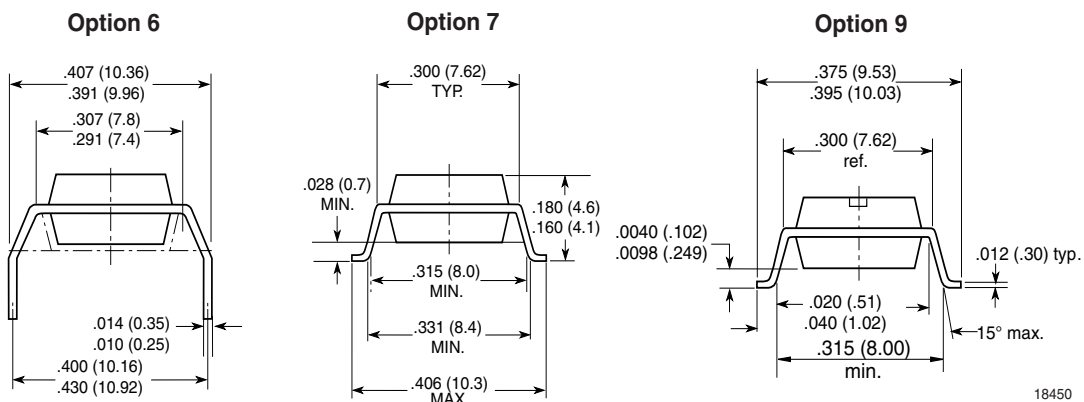



Ozone Depleting Substances Policy Statement

It is the policy of **Vishay Semiconductor GmbH** to

1. Meet all present and future national and international statutory requirements.
2. Regularly and continuously improve the performance of our products, processes, distribution and operating systems with respect to their impact on the health and safety of our employees and the public, as well as their impact on the environment.

It is particular concern to control or eliminate releases of those substances into the atmosphere which are known as ozone depleting substances (ODSs).

The Montreal Protocol (1987) and its London Amendments (1990) intend to severely restrict the use of ODSs and forbid their use within the next ten years. Various national and international initiatives are pressing for an earlier ban on these substances.

Vishay Semiconductor GmbH has been able to use its policy of continuous improvements to eliminate the use of ODSs listed in the following documents.

1. Annex A, B and list of transitional substances of the Montreal Protocol and the London Amendments respectively
2. Class I and II ozone depleting substances in the Clean Air Act Amendments of 1990 by the Environmental Protection Agency (EPA) in the USA
3. Council Decision 88/540/EEC and 91/690/EEC Annex A, B and C (transitional substances) respectively.

Vishay Semiconductor GmbH can certify that our semiconductors are not manufactured with ozone depleting substances and do not contain such substances.

**We reserve the right to make changes to improve technical design
and may do so without further notice.**

Parameters can vary in different applications. All operating parameters must be validated for each customer application by the customer. Should the buyer use Vishay Semiconductors products for any unintended or unauthorized application, the buyer shall indemnify Vishay Semiconductors against all claims, costs, damages, and expenses, arising out of, directly or indirectly, any claim of personal damage, injury or death associated with such unintended or unauthorized use.

Vishay Semiconductor GmbH, P.O.B. 3535, D-74025 Heilbronn, Germany
Telephone: 49 (0)7131 67 2831, Fax number: 49 (0)7131 67 2423