

FEATURES

- InGaP HBT Technology
- -50 dBc ACPR @ ± 5 MHz, +27 dBm
- 29 dB Gain
- High Efficiency
- Low Transistor Junction Temperature
- Matched for a 50 Ω System
- Low Profile Miniature Surface Mount Package; RoHS Compliant
- Multi-Carrier Capability

APPLICATIONS

- WCDMA, HSDPA and LTE Air Interfaces
- Picocell, Femtocell, Home Nodes
- Customer Premises Equipment (CPE)
- Data Cards and Terminals

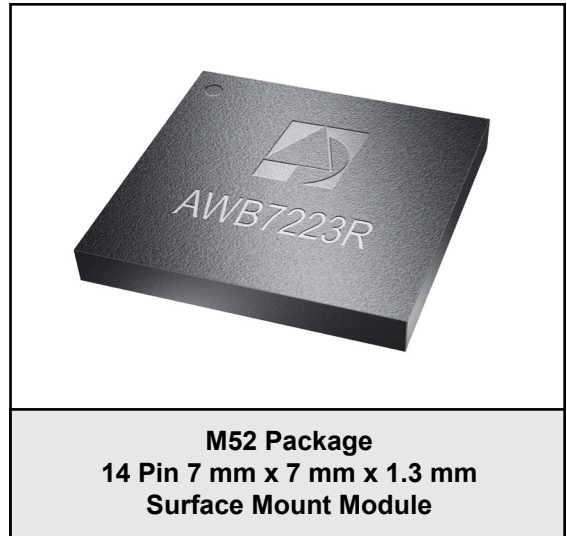

PRODUCT DESCRIPTION

The AWB7223 is a fully matched, Multi-Chip-Module (MCM) designed for picocell, femtocell, and customer premises equipment (CPE) applications. Its high linearity and efficiency meet the extremely demanding needs of small cell infrastructure architectures. Designed for WCDMA, HSDPA, and LTE air interfaces operating in the 1.930 GHz to 1.995 GHz band, the AWB7223 delivers up to +27 dBm of WCDMA (64 DPCH) power with an ACPR better than -50 dBc. It

operates from a convenient +4.5 V supply and provides 29 dB of gain. The device is manufactured using an advanced InGaP HBT MMIC technology offering state-of-the-art reliability, temperature stability, and ruggedness. The self-contained 7 mm x 7 mm x 1.3 mm surface mount package incorporates RF matching networks optimized for output power, efficiency, and linearity in a 50 Ω system.

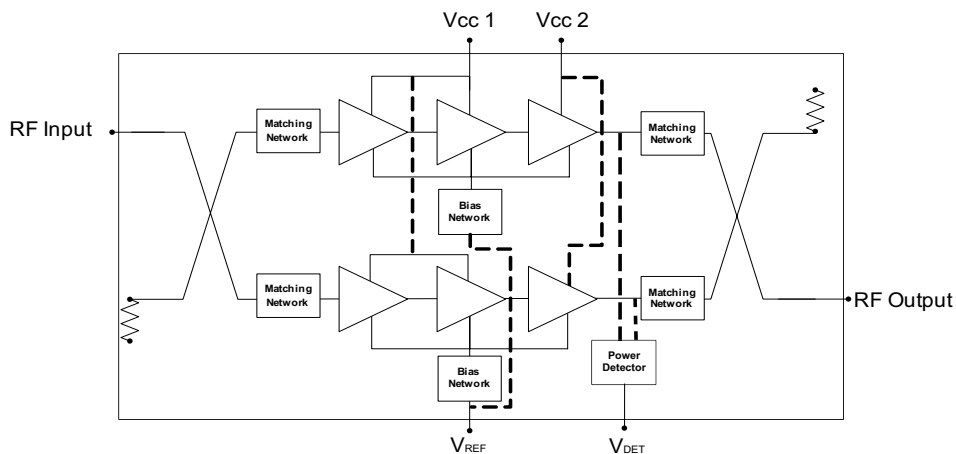

Figure 1: Block Diagram

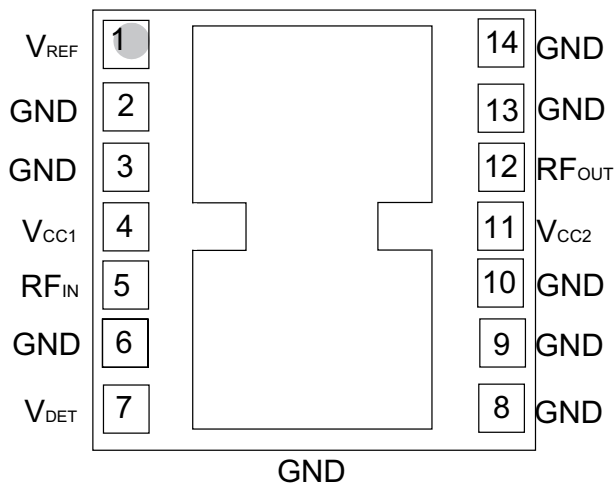

Figure 2: Pinout (X-ray Top View)

Table 1: Pin Description

PIN	NAME	DESCRIPTION
1	V_{REF}	Reference Voltage
2	GND	Ground
3	GND	Ground
4	V_{CC1}	Supply Voltage
5	RF_{IN}	RF Input
6	GND	Ground
7	V_{DET}	Detector Output
8	GND	Ground
9	GND	Ground
10	GND	Ground
11	V_{CC2}	Supply Voltage
12	RF_{OUT}	RF Output
13	GND	Ground
14	GND	Ground

ELECTRICAL CHARACTERISTICS

Table 2: Absolute Minimum and Maximum Ratings

PARAMETER	MIN	MAX	UNIT
Supply Voltage (V_{CC})	0	+5	V
Reference Voltage (V_{REF})	0	+3.5	V
RF Output Power (P_{OUT})	-	+30	dBm
ESD Rating Human Body Model ⁽¹⁾ Charged Device Model ⁽²⁾	Class 1C Class IV	- -	
MSL Rating ⁽³⁾	4	-	
Junction Temperature (T_j)	-	+150	°C
Storage Temperature (T_{STG})	-40	+150	°C

Stresses in excess of the absolute ratings may cause permanent damage. Functional operation is not implied under these conditions. Exposure to absolute ratings for extended periods of time may adversely affect reliability.

Notes:

(1) JEDEC JS-001-2010.

(2) JEDEC JESD22-C101D.

(3) 260 °C peak reflow.

Table 3: Operating Ranges

PARAMETER	MIN	TYP	MAX	UNIT	COMMENTS
Operating Frequency (f)	1930	-	1995	MHz	
Supply Voltage (V_{CC})	+3.6	+4.5	+4.65	V	
Reference Voltage (V_{REF})	+2.75 0	+2.85 -	+2.95 +0.5	V	PA "on" PA "shut down"
RF Output Power (P_{OUT})	-	+27	-	dBm	
Case Temperature (T_C)	-40	-	+85	°C	

The device may be operated safely over these conditions; however, parametric performance is guaranteed only over the conditions defined in the electrical specifications.

Table 4: Electrical Specifications
 (T_C = +25 °C, V_{CC} = +4.5 V, V_{REF} = +2.85 V, 50 Ω system)

PARAMETER	MIN	TYP	MAX	UNIT	COMMENTS
Gain ⁽²⁾	27	29	34	dB	1930 - 1995 MHz
ACPR ^{(1), (2), (3)} @ 5 MHz @ 10 MHz	- -	-50 -63	-47 -60	dBc	
Power-Added Efficiency ^{(1), (2), (3)}	12	14	-	%	
Thermal Resistance (R _{JC}) ⁽⁴⁾	-	12	-	°C/W	Junction to Case
Supply Current ^{(1), (2), (3)}	-	795	-	mA	total through V _{CC} pins
Quiescent Current (I _q)	200	275	330	mA	
Reference Current	12	14	19	mA	through V _{REF} pin
Leakage Current	-	3	10	μA	V _{CC} = +5 V, V _{REF} = 0 V
Harmonics 2f _o 3f _o , 4f _o	- -	-50 -54	-45 -50	dBc	
Input Return Loss	15	20	-	dB	
Output Return Loss	15	20	-	dBm	
P1dB	-	+35	-	dBm	CW tone
Spurious Output Level (all spurious outputs)	-	-	-60	dBc	P _{OUT} ≤ +27 dBm In-band load VSWR < 5:1 Out-of-band load VSWR < 10:1 Applies over all voltage and temperature operating ranges
Load mismatch stress with no permanent degradation or failure	8:1	-	-	VSWR	V _{CC} = +4.5 V, P _{OUT} = +27 dBm Applies over full operating temperature range

Notes:

(1) ACPR and Efficiency measured at 1960 MHz.

(2) P_{OUT} = +27 dBm.

(3) TM1 WCDMA 64 DPCH.

(4) Use only V_{CC2} (pin 11) current when calculating device junction temperature.

APPLICATION INFORMATION

To ensure proper performance, refer to all related Application Notes on the ANADIGICS web site: <http://www.anadigics.com>

Shutdown Mode

The power amplifier may be placed in a shutdown mode by applying logic low levels (see Operating Ranges table) to the V_{REF} voltage.

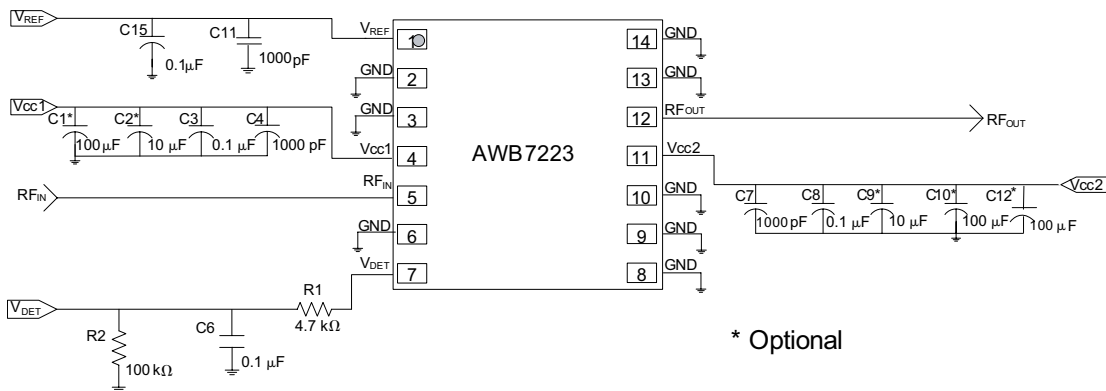
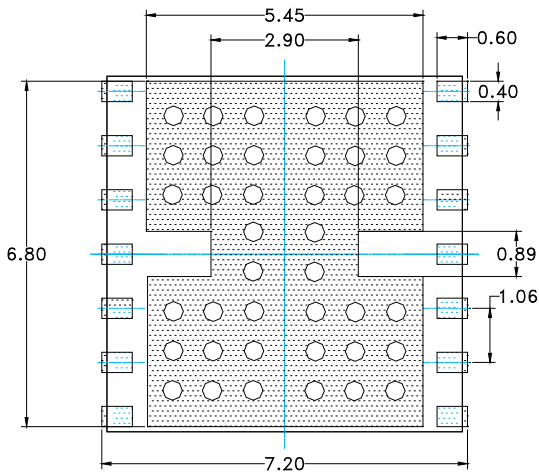
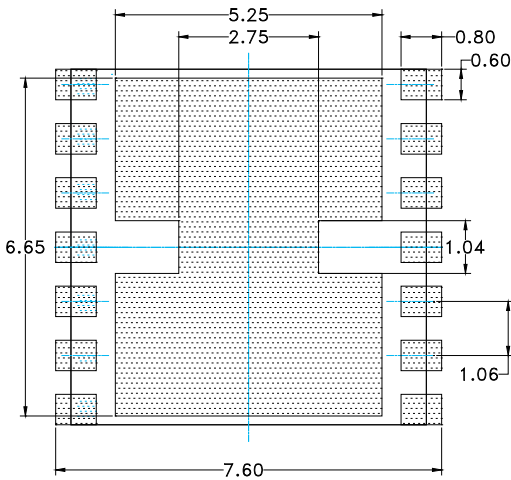

Figure 3: Application Circuit Schematic



PCB METAL
TOP (X-RAY) VIEW
ONLY PACKAGE I/O's AND
GROUND REQUIREMENTS
SHOWN.



PCB SOLDER MASK
TOP (X-RAY) VIEW

NOTES:

- (1) UNLESS SPECIFIED DIMENSIONS ARE SYMMETRICAL ABOUT CENTER LINES SHOWN.
- (2) DIMENSIONS IN MILLIMETERS.
- (3) VIAS SHOWN IN PCB METAL VIEW ARE FOR REFERENCE ONLY. NUMBER & SIZE OF THERMAL VIAS REQUIRED DEPENDENT ON HEAT DISSIPATION REQUIREMENT AND THE PCB PROCESS CAPABILITY.

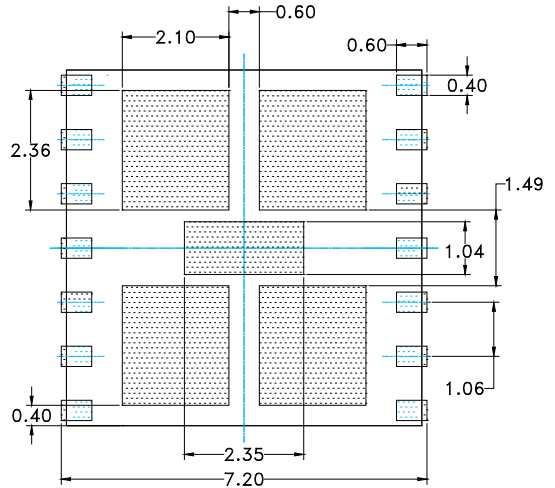

STENCIL APERTURE
TOP (X-RAY) VIEW

Figure 4: PCB Footprint

PACKAGE OUTLINE

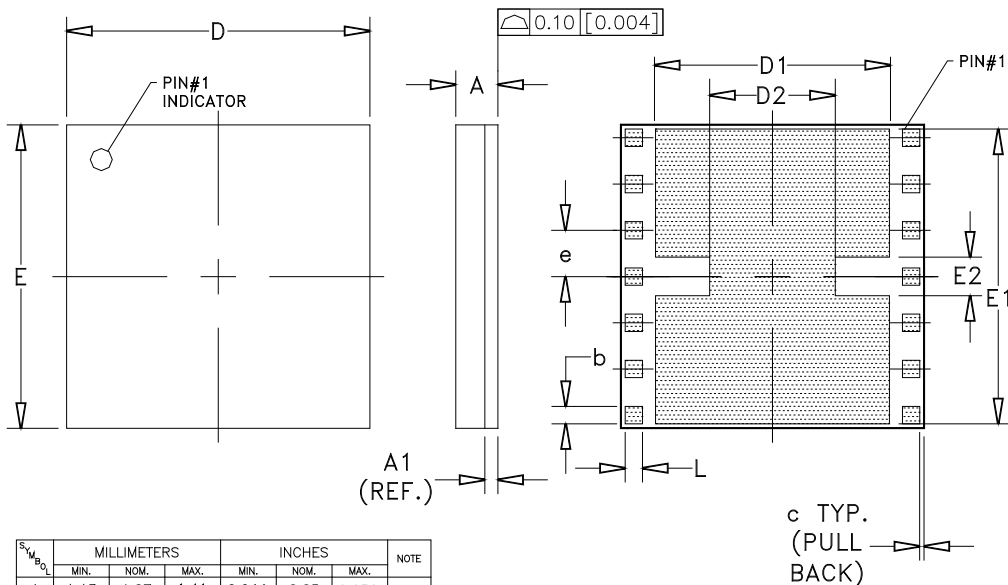

SYMBOL	MILLIMETERS			INCHES			NOTE
	MIN.	NOM.	MAX.	MIN.	NOM.	MAX.	
A	1.13	1.27	1.41	0.044	0.05	0.056	—
A1	0.27 (REF)			0.011 (REF)			—
b	0.387	0.400	0.413	0.0152	0.0157	0.0162	14X
c	—	0.10	—	—	0.004	—	—
D	6.88	7.00	7.12	0.270	0.275	0.280	—
D1	5.30	5.45	5.60	0.208	0.214	0.220	—
D2	2.87	2.90	2.93	0.113	0.114	0.115	—
E	6.88	7.00	7.12	0.270	0.275	0.280	—
E1	6.78	6.80	6.82	0.266	0.267	0.268	—
E2	0.86	0.89	0.92	0.034	0.035	0.036	—
e	1.07			0.0421			6X
L	0.387	0.400	0.413	0.0152	0.0157	0.0162	14X

NOTES:

1. CONTROLLING DIMENSIONS: MILLIMETERS
2. UNLESS SPECIFIED TOLERANCE=±0.076[0.003].
3. PADS (INCLUDING CENTER) SHOWN UNIFORM SIZE FOR REFERENCE ONLY. ACTUAL PAD SIZE AND LOCATION WILL VARY WITHIN MIN. AND MAX. DIMENSIONS ACCORDING TO SPECIFIC LAMINATE DESIGN.

Figure 5: M52 Package Outline - 14 Pin 7 mm x 7 mm x 1.3 mm Surface Mount Module

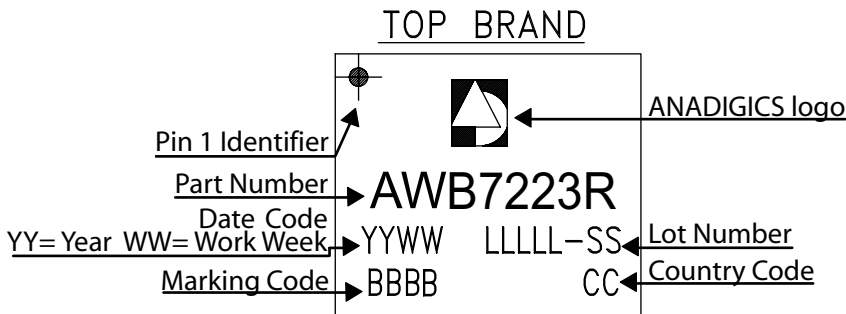

Figure 6: Branding Specification

COMPONENT PACKAGING

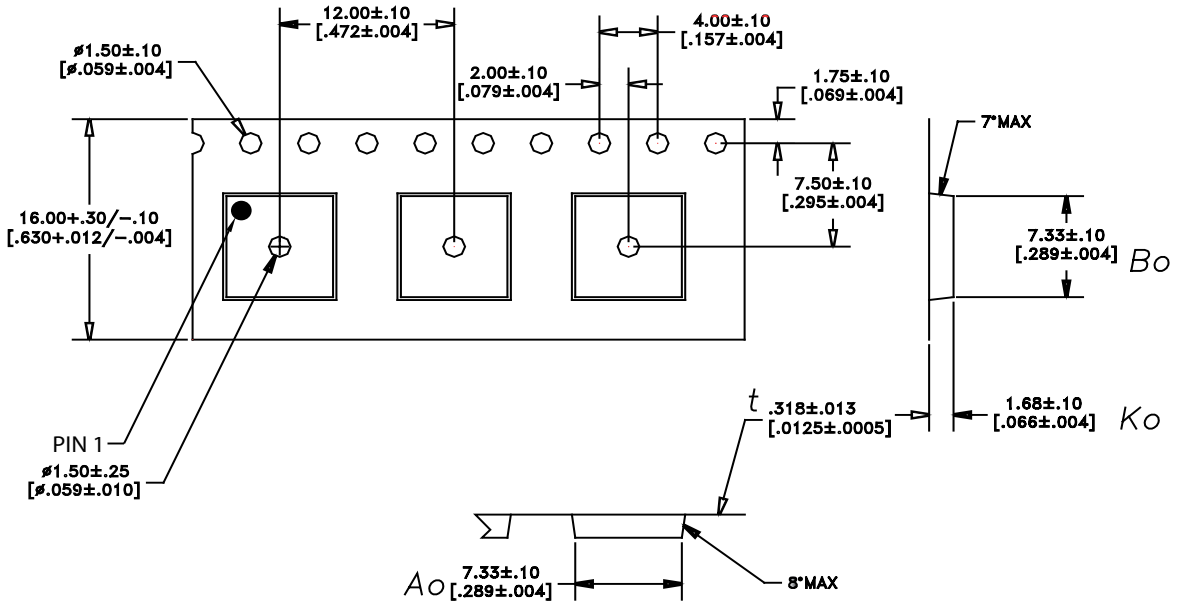

Figure 7: Tape & Reel Packaging

Table 5: Tape & Reel Dimensions

PACKAGE TYPE	TAPE WIDTH	POCKET PITCH	REEL CAPACITY	MAX REEL DIA
7 mm x 7 mm x 1.3 mm	16 mm	12 mm	2500	13"

ORDER NUMBER	TEMPERATURE RANGE	PACKAGE DESCRIPTION	COMPONENT PACKAGING
AWB7223RM52P8	-40 °C to +85 °C	RoHS-compliant 14 Pin 7 mm x 7 mm x 1.3 mm Surface Mount Module	Tape and Reel, 2500 pieces per Reel



ANADIGICS, Inc.
141 Mount Bethel Road
Warren, New Jersey 07059, U.S.A.
Tel: +1 (908) 668-5000
Fax: +1 (908) 668-5132

URL: <http://www.anadigics.com>

IMPORTANT NOTICE

ANADIGICS, Inc. reserves the right to make changes to its products or to discontinue any product at any time without notice. The product specifications contained in Advanced Product Information sheets and Preliminary Data Sheets are subject to change prior to a product's formal introduction. Information in Data Sheets have been carefully checked and are assumed to be reliable; however, ANADIGICS assumes no responsibilities for inaccuracies. ANADIGICS strongly urges customers to verify that the information they are using is current before placing orders.

WARNING

ANADIGICS products are not intended for use in life support appliances, devices or systems. Use of an ANADIGICS product in any such application without written consent is prohibited.