

500 WATT MULTI-LINE LOW CAPACITANCE TVS ARRAY



DESCRIPTION

The PLCDAxxC-6 Series are low capacitance multi-line transient voltage suppressor arrays that provides board level protection for standard TTL and CMOS bus line applications against the damaging effects of ESD, tertiary lightning and switching transients.

The PLCDAxxC-6 Series has a peak pulse power rating of 500 Watts for an 8/20 μ s waveshape. This device series meets the IEC 61000-4-2, IEC 61000-4-4 and IEC 61000-4-5 requirements.

FEATURES

- Compatible with IEC 61000-4-2 (ESD): Air - 15kV, Contact - 8kV
- Compatible with IEC 61000-4-4 (EFT): 40A - 5/50ns
- Compatible with IEC 61000-4-5 (Surge): 24A, 8/20 μ s - Level 2(Line-Gnd) & Level 3(Line-Line)
- 500 Watts Peak Pulse Power per Line (tp = 8/20 μ s)
- Bidirectional Configuration
- Available in Multiple Voltages Ranging from 3V to 15V
- Protects Up to Six Lines
- Low Capacitance: 8pF
- RoHS Compliant
- REACH Compliant

APPLICATIONS

- Computer Interface Protection
- Ethernet - 10/100/1000 Base T
- Bluetooth & RF

MECHANICAL CHARACTERISTICS

- Molded JEDEC SO-8 Package
- Approximate Weight: 70 milligrams
- Lead-Free Pure-Tin Plating (Annealed)
- Solder Reflow Temperature:
Pure-Tin - Sn, 100: 260-270°C
- 12mm Tape and Reel Per EIA Standard 481
- Flammability Rating UL 94V-0

PIN CONFIGURATION

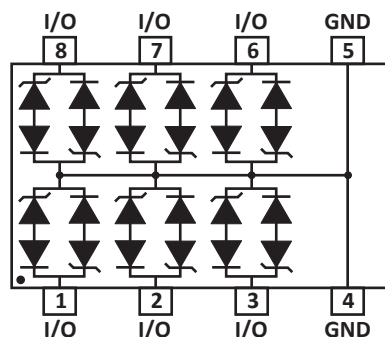

TYPICAL DEVICE CHARACTERISTICS
MAXIMUM RATINGS @ 25°C Unless Otherwise Specified

PARAMETER	SYMBOL	VALUE	UNITS
Operating Temperature	T_L	-55 to 150	°C
Storage Temperature	T_{STG}	-55 to 150	°C
Peak Pulse Power ($t_p = 8/20\mu s$) - See Figure 1	P_{PP}	500	Watts

ELECTRICAL CHARACTERISTICS PER LINE @ 25°C Unless Otherwise Specified

PART NUMBER	DEVICE MARKING	RATED STAND-OFF VOLTAGE	MINIMUM BREAKDOWN VOLTAGE	MAXIMUM CLAMPING VOLTAGE (Fig. 2)	MAXIMUM LEAKAGE CURRENT	MAXIMUM CAPACITANCE (Note 1)
		V_{WM} VOLTS	@1mA $V_{(BR)}$ VOLTS	@ $I_p = 1A$ V_C VOLTS	@ V_{WM} I_D μA	@0V, 1MHz C pF
PLCDA03C-6	PRS	3.3	4.5	7.0	125	8
PLCDA05C-6	PRT	5.0	6.0	9.8	20	8
PLCDA08C-6	PRW	8.0	8.5	13.4	10	8
PLCDA12C-6	PRV	12.0	13.3	19.0	2	8
PLCDA15C-6	PRU	15.0	16.7	24.0	2	8

NOTES

1. Capacitance between I/O pins and ground (pins 4 and 5) is typically 8pF. Capacitance between I/O pins is typically 4pF.

FIGURE 1
PEAK PULSE POWER VS PULSE TIME

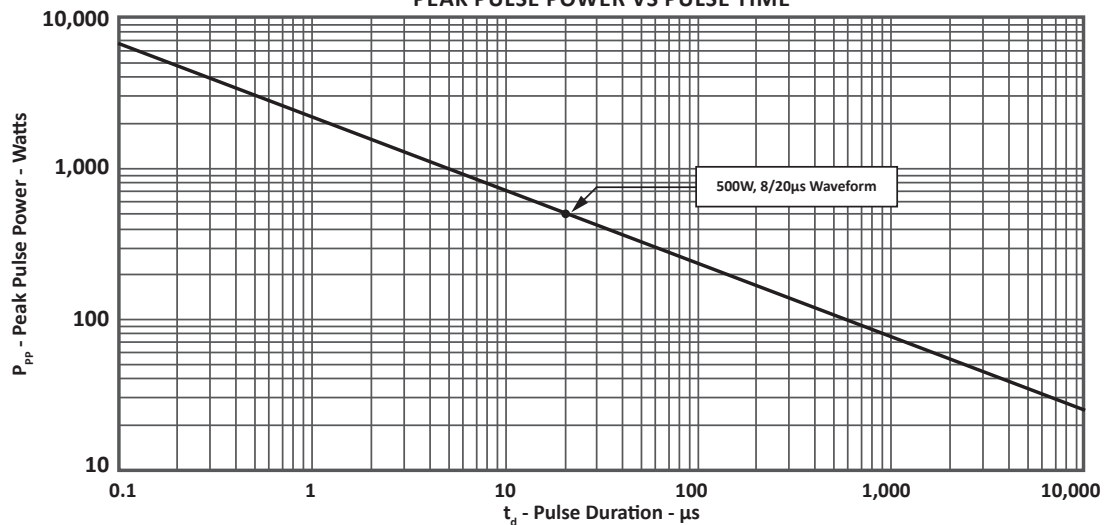

TYPICAL DEVICE CHARACTERISTICS

FIGURE 2
PULSE WAVE FORM

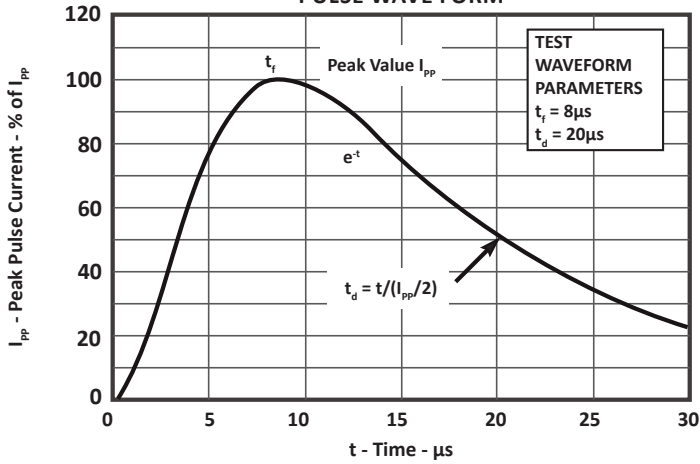

FIGURE 3
POWER DERATING CURVE

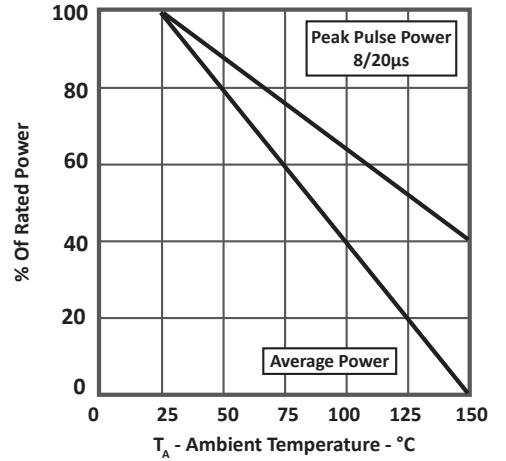
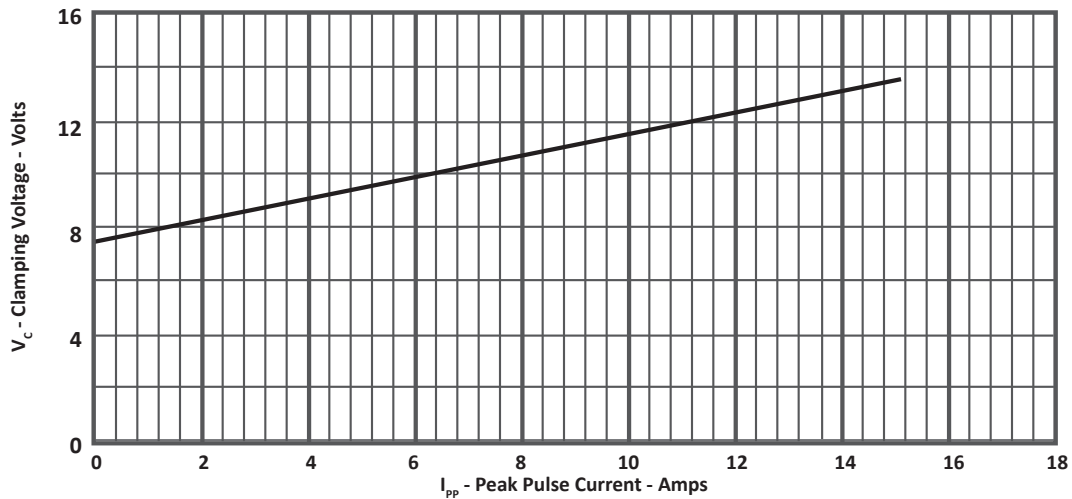
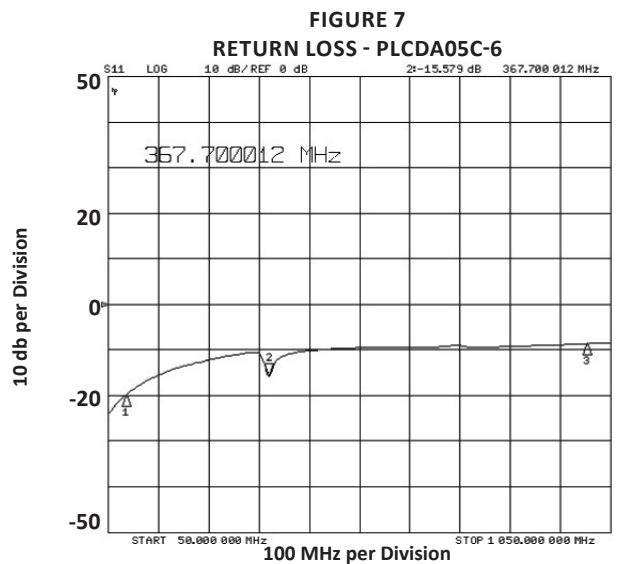
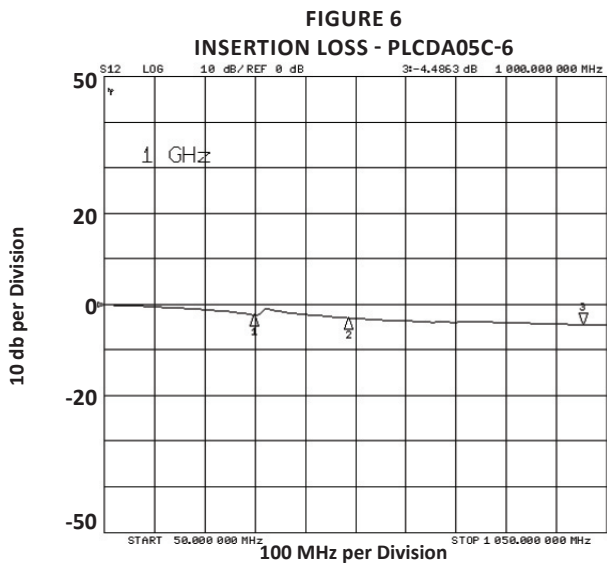
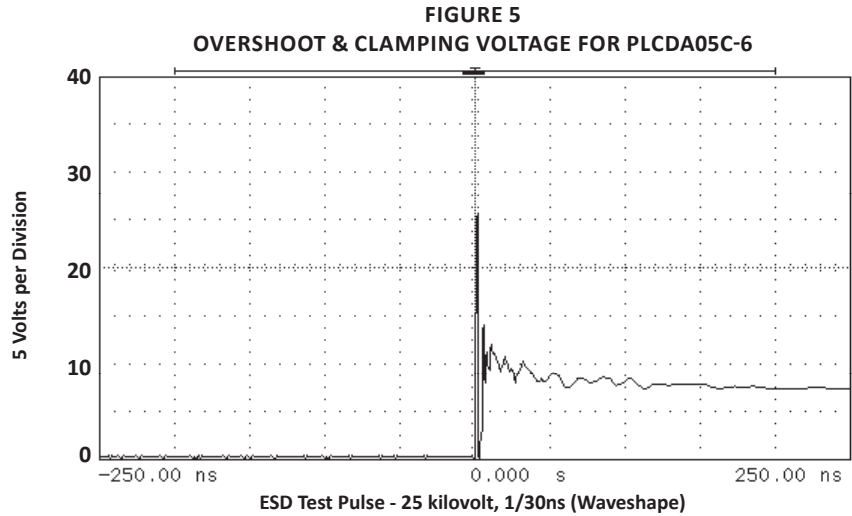

FIGURE 4
TYPICAL CLAMPING VOLTAGE VS PEAK PULSE CURRENT FOR PLCDA05C-6



TYPICAL DEVICE CHARACTERISTICS



SPICE MODEL

FIGURE 1
SPICE MODEL

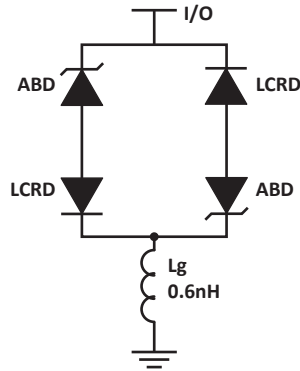

ABD - Avalanche Breakdown Diode (TVS)
 LCRD: Low Capacitance Rectifier Diode
 Lg - Lead Inductance

TABLE 1 - SPICE PARAMETERS

PARAMETER	UNIT	ABD(TVS)	LCRD
BV	V	See Table 2	200
IBV	μA	1	0.01
C_{jo}	pF	See Table 2	5
I_s	A	See Table 2	1E-13
Vj	V	0.6	0.6
M	-	0.33	0.33
N	-	1	1
R_s	Ohms	See Table 2	0.31
TT	s	1E-8	1E-9
EG	eV	1.11	1.11

TABLE 2 - ABD SPECIFIC SPICE PARAMETERS

PART NUMBER	B_v (VOLTS)	C_{jo} (pF)	I_s (AMPS)	R_s (OHMS)
PLCDA03	4.5	438	1E-11	0.21
PLCDA05	6.0	284	1E-11	0.14
PLCDA15	16.7	102	1E-13	0.52

APPLICATION INFORMATION

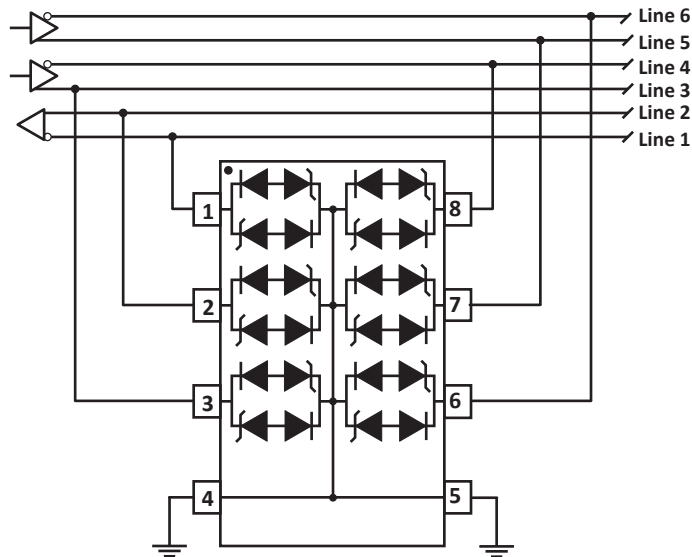

FIGURE 1 - BIDIRECTIONAL COMMON-MODE PROTECTION FOR A TRANSCEIVER

Circuit connectivity is as follows:

- Line 1 connected to Pin 1.
- Line 2 connected to Pin 2.
- Line 3 connected to Pin 3.
- Line 4 connected to Pin 8.
- Line 5 connected to Pin 7.
- Line 6 connected to Pin 6.
- Pins 4 and 5 connected to ground.

CIRCUIT BOARD RECOMMENDATIONS

Circuit board layout is critical for electromagnetic compatibility protection. The following guidelines are recommended:

- The protection device should be placed near the input terminals or connectors, the device will divert the transient current immediately before it can be coupled into the nearby traces.
- The path length between the TVS device and the protected line should be minimized.
- All conductive loops including power and ground loops should be minimized.
- The transient current return path to ground should be kept as short as possible to reduce parasitic inductance.
- Ground planes should be used whenever possible. For multilayer PCBs, use ground vias.

SO-8 PACKAGE INFORMATION

OUTLINE DIMENSIONS

DIM	MILLIMETERS		INCHES	
	MIN	MAX	MIN	MAX
A	4.80	5.00	0.189	0.196
B	3.80	4.00	0.150	0.157
C	1.35	1.75	0.054	0.068
D	0.35	0.49	0.014	0.019
F	0.40	1.25	0.016	0.049
G	1.27 BSC		0.05 BSC	
J	0.18	0.25	0.007	0.009
K	0.10	0.25	0.004	0.008
P	5.80	6.20	0.229	0.244
R	0.25	0.50	0.010	0.019

NOTES

- T = Seating plane and datum surface.
- Dimensions "A" and "B" are datum.
- Dimensions "A" and "B" do not include mold protrusion.
- Maximum mold protrusion is 0.015" (0.380mm) per side.
- Dimensioning and tolerances per ANSI Y14.5M, 1982.
- Dimensions are exclusive of mold flash and metal burrs.

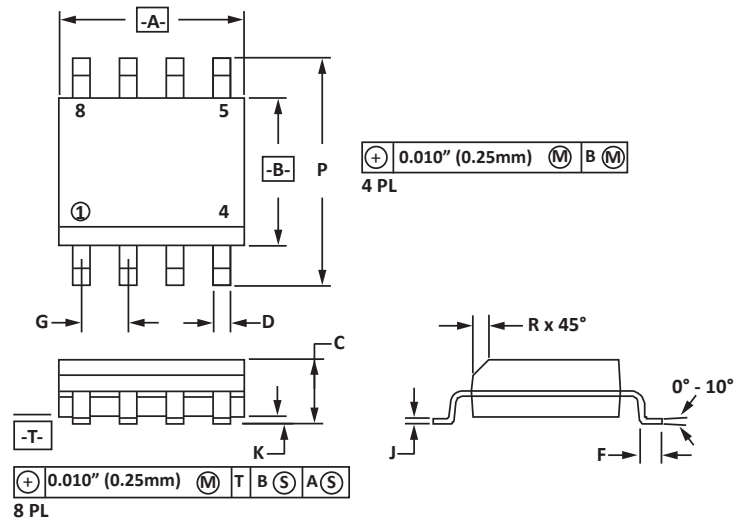

PAD LAYOUT DIMENSIONS

DIM	MILLIMETERS		INCHES	
	MIN	MAX	MIN	MAX
A	1.14	1.40	0.045	0.055
B	0.64	0.89	0.025	0.035
C	6.22	-	0.245	-
D	3.94	4.17	0.155	0.165
E	1.02	1.27	0.040	0.050

NOTES

- Controlling dimension: inches.

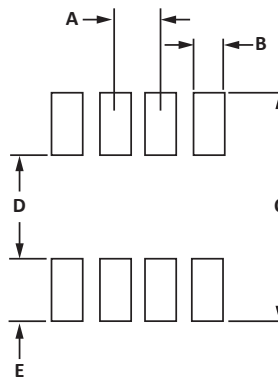

TAPE AND REEL

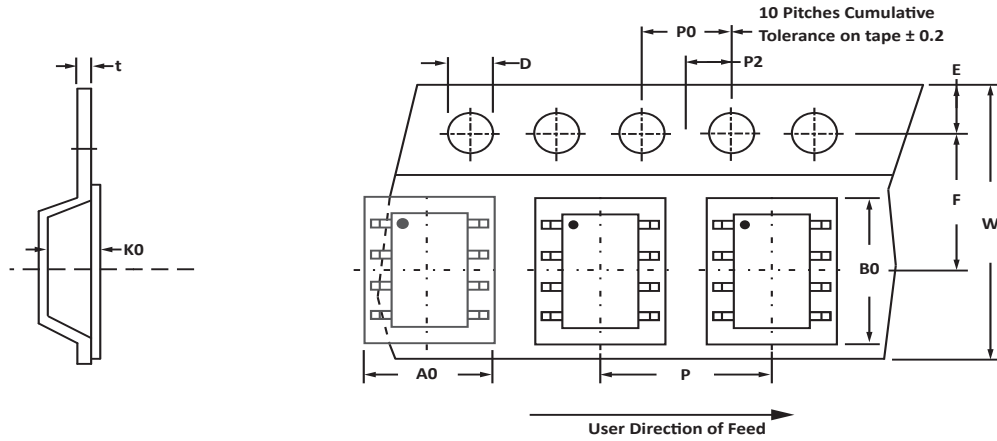

SPECIFICATIONS

REEL DIA.	TAPE WIDTH	A0	B0	K0	D	E	F	W	P0	P2	P	tmax
178mm (7")	12mm	6.50 ± 0.10	5.40 ± 0.10	2.00 ± 0.10	1.50 ± 0.10	1.75 ± 0.10	5.50 ± 0.05	12.00 ± 0.30	4.00 ± 0.12	2.00 ± 0.10	4.00 ± 0.10	0.25

NOTES

- Dimensions are in millimeters.
- Surface mount product is taped and reeled in accordance with EIA-481.
- Suffix - T7 = 7" Reel - 1,000 pieces per 12mm tape.
- Suffix - T13 = 13" Reel - 2,500 pieces per 12mm tape.
- Bulk product shipped in tubes of 98 pieces per tube.
- Marking on Part - marking code (see page 2), date code, logo and pin one defined by dot on top of package.

Package outline, pad layout and tape specifications per document number 06009.R3 9/10.

ORDERING INFORMATION

BASE PART NUMBER (xx = Voltage)	LEADFREE SUFFIX	TAPE SUFFIX	QTY/REEL	REEL SIZE	TUBE QTY
PLCDAxxC-6	-LF	-T7	1,000	7"	98
PLCDAxxC-6	-LF	-T13	2,500	13"	98

This device is only available in a Lead-Free configuration.

COMPANY INFORMATION

COMPANY PROFILE

In business more than 20 years, ProTek Devices™ is a privately-held company located in Tempe, Arizona, that offers a product line of transient voltage suppressors (TVS); avalanche breakdown diodes; steering diode TVS arrays and other surge suppressor component products. These TVS devices protect electronic systems from the effects of lightning, electrostatic discharge (ESD), nuclear electromagnetic pulses (NEMP), inductive switching and EMI / RFI. ProTek Devices also offers high performance interface and linear products that include analog switches; multiplexers; LED drivers; audio control ICs; RF and related high frequency products. The analog devices work in a host of consumer; industrial; automotive and other applications.

CONTACT US

Corporate Headquarters

2929 South Fair Lane
Tempe, Arizona 85282
USA

By Telephone

General: 602-431-8101
Sales: & Marketing: 602-414-5109
Customer Service: 602-414-5114
Product Technical Support: 602-414-5107

By Fax

General: 602-431-2288

By E-mail:

Sales: sales@protekdevices.com
Customer Service: service@protekdevices.com
Technical Support: support@protekdevices.com

ProTek Devices (Asia Pacific) Pte. Ltd.

8 Ubi Road 2, #06-19
Zervex
Singapore - 408538
Tel: +65-67488312
Fax: +65-67488313

Web

www.protekdevices.com

COPYRIGHT © ProTek Devices 2007 - This literature is subject to all applicable copyright laws and is not for resale in any manner.

SPECIFICATIONS: ProTek reserves the right to change the electrical and or mechanical characteristics described herein without notice.

DESIGN CHANGES: ProTek reserves the right to discontinue product lines without notice and that the final judgement concerning selection and specifications is the buyer's and that in furnishing engineering and technical assistance. ProTek assumes no responsibility with respect to the selection or specifications of such products. ProTek makes no warranty, representation or guarantee regarding the suitability of its products for any particular purpose, nor does ProTek assume any liability arising out of the application or use of any product or circuit and specifically disclaims any and all liability without limitation special, consequential or incidental damages.

LIFE SUPPORT POLICY: ProTek Devices products are not authorized for use in life support systems without written consent from the factory.