

## FRACTIONAL-N PLL WITH INTEGRATED VCO 1310 - 1415, 2620 - 2830, 5240 - 5660 MHz

### Features

- RF Bandwidth: 1310-1415, 2620-2830, 5240-5660 MHz
- Ultra Low Phase Noise -110 dBc/Hz in Band Typ.
- Figure of Merit (FOM) -227 dBc/Hz
- <180 fs RMS Jitter
- 24-bit Step Size, Resolution 3 Hz typ
- Exact Frequency Mode
- Built in Digital Self Test
- 40 Lead 6x6 mm SMT Package: 36 mm<sup>2</sup>

### Typical Applications

- Cellular/4G Infrastructure
- Repeaters and Femtocells
- Communications Test Equipment
- CATV Equipment
- Phased Array Applications
- DDS Replacement
- Very High Data Rate Radios

### Functional Diagram

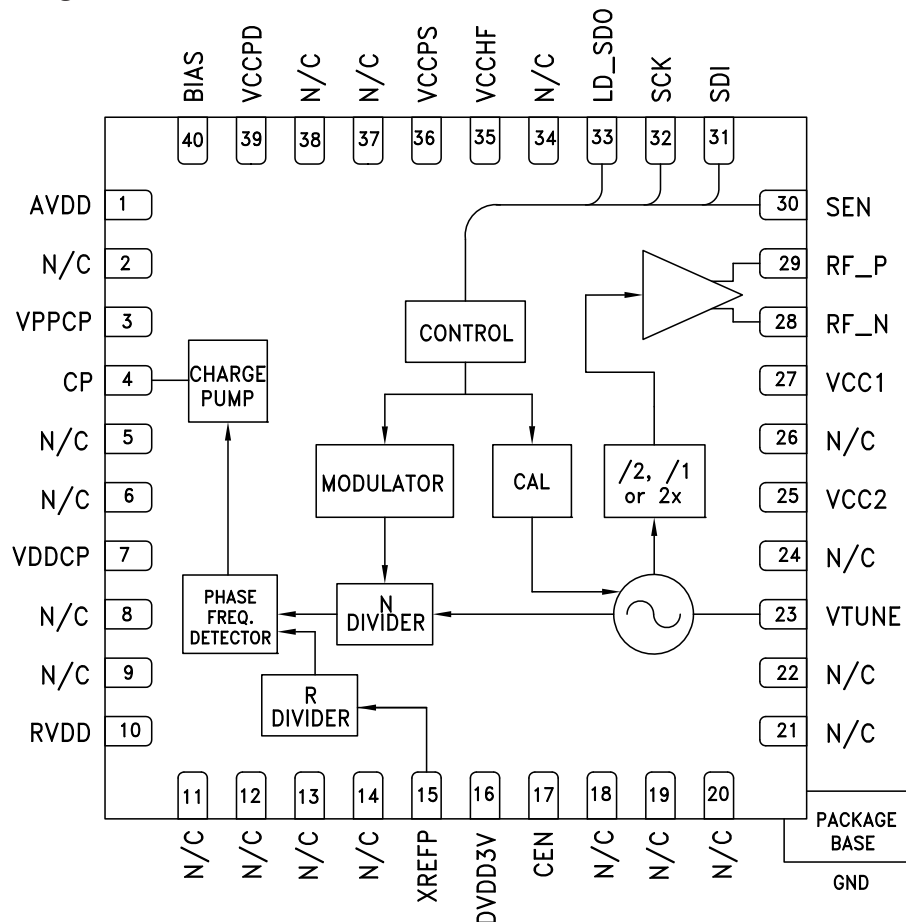



## FRACTIONAL-N PLL WITH INTEGRATED VCO

### 1310 - 1415, 2620 - 2830, 5240 - 5660 MHz

### General Description

The HMC840LP6CE is a fully featured Fractional-N Phase-Locked-Loop (PLL) Frequency Synthesizer with an Integrated Voltage Controlled Oscillator (VCO). The synthesizer consists of an integrated low noise VCO with a tri-band output, an autocalibration subsystem for low voltage VCO tuning, a very low noise digital Phase Detector (PD), a precision controlled charge pump, a low noise reference path divider and a fractional divider.

The fractional synthesizer features an advanced delta-sigma modulator design that allows both ultra-fine step sizes and low spurious products. The phase detector (PD) features cycle slip prevention (CSP) technology to allow faster frequency hopping times. Ultra low in-close phase noise and low spurious also allows wider loop bandwidths for faster frequency hopping and low micro-phonics.

For theory of operation and register map refer to the “[PLLs with Integrated VCOs - RF VCOs Operating Guide](#)”. To view the Operating Guide, please visit [www.hittite.com](http://www.hittite.com) and choose HMC840LP6CE from the “Search by Part Number” pull down menu.

### Electrical Specifications

**VPPCP, VDDCP, VCC1, VCC2 = 5V; RVDD, AVDD, DVDD3V, VCCPD, VCCHF, VCCPS = 3.3V**  
**GNDCP = GNDLS = Ground Paddle = 0V, Min and Max Specified across Temp**

Parameter	Condition	Min.	Typ.	Max.	Units
<b>RF Output Characteristics</b>					
VCO Frequency at PLL Input		2620		2830	MHz
RF Output Frequency at $f_{VCO}/2$		1310		1415	MHz
RF Output Frequency at $f_{VCO}$		2620		2830	MHz
RF Output Frequency at $2f_{VCO}$		5240		5660	MHz
<b>Output Power</b>					
RF Output Power at $f_{VCO}/2$	matched at the frequency of interest, vs temperature	8.5	10	11.5	dBm
RF Output Power at $f_{VCO}$		7	9	11	dBm
RF Output Power at $2f_{VCO}$		-5.5	-3	0.5	dBm
VCO Tuning Sensitivity	Measured at $f_o$ , 2V	10.5	12.6	15.6	MHz/V
VCO Supply Pushing	Measured at $f_o$ , 2V		1.5		MHz/V
<b>Harmonics</b>					
RF Output $F_{out}/2$ Harmonic	Doubler Mode		-26		dBc
RF Output $3F_{out}/2$ Harmonic	Doubler Mode		-27		dBc
RF Output 2nd Harmonic	$f_o/2/f_o/2f_o$		-19 / -20 / -25		dBc
RF Output $5F_{out}/2$ Harmonic	Doubler Mode		-41		dBc
RF Output 3rd Harmonic	$f_o/2/f_o/2f_o$		-26 / -34 / -42		dBc
RF Output $7F_{out}/2$ Harmonic	Doubler Mode		-66		dBc
RF Output 4th Harmonic	$f_o/2/f_o/2f_o$		-28 / -48 / -61		dBc
<b>RF Divider Characteristics</b>					
19-Bit N-Divider Range (Integer)	Max = $2^{19} - 1$			524,287	
19-Bit N-Divider Range (Fractional)	Fractional nominal divide ratio varies (-3 / +4) dynamically max			524,283	
<b>REF Input Characteristics</b>					
Max Ref Input Frequency			50	200	MHz
Ref Input Range	AC Coupled	1	2	3.3	Vp-p
Ref Input Capacitance				5	pF
14-Bit R-Divider Range		1		16,383	

**FRACTIONAL-N PLL WITH INTEGRATED VCO**  
**1310 - 1415, 2620 - 2830, 5240 - 5660 MHz**
**Electrical Specifications (Continued)**

Parameter	Condition	Min.	Typ.	Max.	Units
<b>Phase Detector (PD)</b>					
PD Frequency Fractional Feedback Mode	[1]	0.1		100	MHz
PD Frequency Fractional Feedforward Mode (and Register 6 [17:16] = 10)		0.1		80	MHz
PD Frequency Integer Mode		0.1		125	MHz
<b>Charge Pump</b>					
Output Current		0.02		2.54	mA
Charge Pump Gain Step Size			20		μA
PD/Charge Pump SSB Phase Noise	50 MHz Ref, Input Referred				
1 kHz			-143		dBc/Hz
10 kHz	Add 1 dB for Fractional		-150		dBc/Hz
100 kHz	Add 3 dB for Fractional		-153		dBc/Hz
<b>Logic Inputs</b>					
VIH Input High Voltage		DVDD3V-0.4		DVDD3V	V
VIL Input Low Voltage		0		0.4	V
<b>Logic Outputs</b>					
VOH Output High Voltage		DVDD3V-0.4		DVDD3V	V
VOL Output Low Voltage		0		0.4	V
<b>Power Supply Voltages</b>					
Analog 3.3V Supplies	AVDD, VCCHF, VCCPS, VCCPD, RVDD	3.0	3.3	3.5	V
Digital Supply	DVDD3V	3.0	3.3	3.5	V
Analog 5V Supplies	VPPCP, VDDCP, VCC1, VCC2	4.8	5	5.2	V
<b>Power Supply Currents</b>					
+5V Analog Charge Pump	VPPCP, VDDCP		5.3		mA
+5V VCO Core and PLL Buffer	VCC2		56		mA
+5V VCO Divider and RF Buffer	VCC1		36		mA
+3.3V Analog	AVDD, VCCHF, VCCPS, VCCPD, RVDD		41		mA
+3.3V Digital	DVDD3V		6.5		mA
Power Down - Crystal Off	Reg 01h=0, Crystal Not Clocked		10		μA
Power Down - Crystal On, 100 MHz	Reg 01h=0, Crystal Clocked 100 MHz		10	200	μA
<b>Power on Reset</b>					
Typical Reset Voltage on DVDD			700		mV
Min DVDD Voltage for No Reset		1.5			V
Power on Reset Delay			250		μs
<b>VCO Open Loop Phase Noise at fo/2</b>					
10 kHz Offset			-88		dBc/Hz
100 kHz Offset			-117		dBc/Hz
1 MHz Offset			-145		dBc/Hz

[1] This maximum phase detector frequency can only be achieved if the minimum N value is respected. eg. In the case of fractional feedback mode, the maximum PFD rate =  $f_{vco}/20$  or 100 MHz, whichever is less.

**FRACTIONAL-N PLL WITH INTEGRATED VCO  
1310 - 1415, 2620 - 2830, 5240 - 5660 MHz**
**Electrical Specifications (Continued)**

Parameter	Condition	Min.	Typ.	Max.	Units
10 MHz Offset			-162		dBc/Hz
100 MHz Offset			-165		dBc/Hz
<b>VCO Open Loop Phase Noise at fo</b>					
10 kHz Offset			-82		dBc/Hz
100 kHz Offset			-111		dBc/Hz
1 MHz Offset			-139		dBc/Hz
10 MHz Offset			-158		dBc/Hz
100 MHz Offset			-171		dBc/Hz
<b>VCO Open Loop Phase Noise at 2fo</b>					
10 kHz Offset			-76		dBc/Hz
100 kHz Offset			-105		dBc/Hz
1 MHz Offset			-133		dBc/Hz
10 MHz Offset			-152		dBc/Hz
100 MHz Offset			-158		dBc/Hz
<b>Closed Loop Phase Noise PLL + VCO at f<sub>vco</sub> with 100 KHz BW Loop Filter Design<sup>[3]</sup></b>					
Integer, 100 MHz PD	1 kHz Offset		-112		dBc/Hz
Integer, 100 MHz PD	10 kHz Offset		-110		dBc/Hz
Integer, 100 MHz PD	100 kHz Offset		-111		dBc/Hz
Integer, 100 MHz PD	1 MHz Offset		-139		dBc/Hz
Integer, 100 MHz PD	10 MHz Offset		-161		dBc/Hz
Integer, 100 MHz PD	100 MHz Offset		-171		dBc/Hz
Integrated Phase Noise	from 10KHz to 100MHz		-56.5		dBc
RMS Jitter			129.5		fsec
Fractional, 100 MHz PD	1 kHz Offset		-111		dBc/Hz
Fractional, 100 MHz PD	10 kHz Offset		-110		dBc/Hz
Fractional, 100 MHz PD	100 kHz Offset		-110		dBc/Hz
Fractional, 100 MHz PD	1 MHz Offset		-139		dBc/Hz
Fractional, 100 MHz PD	10 MHz Offset		-160		dBc/Hz
Fractional, 100 MHz PD	100 MHz Offset		-171		dBc/Hz
Integrated Phase Noise	from 10KHz to 100MHz		-56.8		dBc
RMS Jitter			123.8		fsec
<b>Closed Loop Phase Noise PLL + VCO at f<sub>vco</sub> with 178 KHz BW Loop Filter Design<sup>[4]</sup></b>					
Integer, 100 MHz PD	1 kHz Offset		-113		dBc/Hz
Integer, 100 MHz PD	10 kHz Offset		-118		dBc/Hz
Integer, 100 MHz PD	100 kHz Offset		-112		dBc/Hz
Integer, 100 MHz PD	1 MHz Offset		-138		dBc/Hz
Integer, 100 MHz PD	10 MHz Offset		-160		dBc/Hz
Integer, 100 MHz PD	100 MHz Offset		-171		dBc/Hz
Integrated Phase Noise	from 10KHz to 100MHz		-59.7		dBc
RMS Jitter			89		fsec
Fractional, 100 MHz PD	1 kHz Offset		-111		dBc/Hz
Fractional, 100 MHz PD	10 kHz Offset		-115		dBc/Hz
Fractional, 100 MHz PD	100 kHz Offset		-109		dBc/Hz

**FRACTIONAL-N PLL WITH INTEGRATED VCO  
1310 - 1415, 2620 - 2830, 5240 - 5660 MHz**
**Electrical Specifications (Continued)**

Parameter	Condition	Min.	Typ.	Max.	Units
Fractional, 100 MHz PD	1 MHz Offset		-138		dBc/Hz
Fractional, 100 MHz PD	10 MHz Offset		-160		dBc/Hz
Fractional, 100 MHz PD	100 MHz Offset		-171		dBc/Hz
Integrated Phase Noise	from 10KHz to 100MHz		-58		dBc
RMS Jitter			108.7		fsec
<b>Closed Loop Phase Noise PLL + VCO at fvco with 71 KHz Loop Filter Design<sup>[5]</sup></b>					
Integer, 50 MHz PD	1 kHz Offset		-110		dBc/Hz
Integer, 50 MHz PD	10 kHz Offse		-105		dBc/Hz
Integer, 50 MHz PD	100 kHz Offset		-109		dBc/Hz
Integer, 50 MHz PD	1 MHz Offset		-139		dBc/Hz
Integer, 50 MHz PD	10 MHz Offset		-160		dBc/Hz
Integer, 50 MHz PD	100 MHz Offset		-171		dBc/Hz
Integrated Phase Noise	from 10KHz to 100MHz		-54.2		dBc
RMS Jitter			169.8		fsec
Fractional, 50 MHz PD	1 kHz Offset		-108		dBc/Hz
Fractional, 50 MHz PD	10 kHz Offset		-104		dBc/Hz
Fractional, 50 MHz PD	100 kHz Offset		-109		dBc/Hz
Fractional, 50 MHz PD	1 MHz Offset		-139		dBc/Hz
Fractional, 50 MHz PD	10 MHz Offset		-160		dBc/Hz
Fractional, 50 MHz PD	100 MHz Offset		-171		dBc/Hz
Integrated Phase Noise	from 10KHz to 100MHz		-53		dBc
RMS Jitter			193.7		fsec
<b>Closed Loop Phase Noise PLL + VCO at fvco with 127 KHz BW Loop Filter Design<sup>[6]</sup></b>					
Integer, 50 MHz PD	1 kHz Offset		-112		dBc/Hz
Integer, 50 MHz PD	10 kHz Offse		-110		dBc/Hz
Integer, 50 MHz PD	100 kHz Offset		-111		dBc/Hz
Integer, 50 MHz PD	1 MHz Offset		-138		dBc/Hz
Integer, 50 MHz PD	10 MHz Offset		-160		dBc/Hz
Integer, 50 MHz PD	100 MHz Offset		-171		dBc/Hz
Integrated Phase Noise	from 10KHz to 100MHz		-57.3		dBc
RMS Jitter			118		fsec
Fractional, 50 MHz PD	1 kHz Offset		-109		dBc/Hz
Fractional, 50 MHz PD	10 kHz Offse		-107		dBc/Hz
Fractional, 50 MHz PD	100 kHz Offset		-110		dBc/Hz
Fractional, 50 MHz PD	1 MHz Offset		-136		dBc/Hz
Fractional, 50 MHz PD	10 MHz Offset		-157		dBc/Hz
Fractional, 50 MHz PD	100 MHz Offset		-171		dBc/Hz
Integrated Phase Noise	from 10KHz to 100MHz		-55.55		dBc
RMS Jitter			144.1		fsec
<b>Figure of Merit</b>					
Normalized 1 Hz					
Floor Integer Mode			-230		dBc/Hz
Floor Fractional Mode			-227		dBc/Hz

For price, delivery, and to place orders: Hittite Microwave Corporation, 20 Alpha Road, Chelmsford, MA 01824

 Phone: 978-250-3343 Fax: 978-250-3373 Order On-line at [www.hittite.com](http://www.hittite.com)

 Application Support: Phone: 978-250-3343 or [apps@hittite.com](mailto:apps@hittite.com)

**FRACTIONAL-N PLL WITH INTEGRATED VCO**  
**1310 - 1415, 2620 - 2830, 5240 - 5660 MHz**
**Electrical Specifications (Continued)**

Parameter	Condition	Min.	Typ.	Max.	Units
Flicker (Both Modes)			-268		dBc/Hz

[2] The closed loop phase noise PLL+VCO at  $f_{vco}/2$  can be calculated by subtracting 6dB. The closed loop phase noise PLL+VCO at  $2f_{vco}$  can be calculated by adding 6dB.

**Loop Filter Configuration Table**

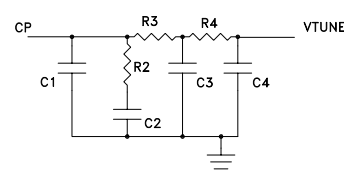
Loop Filter Configuration	C1 (pF)	C2 (nF)	C3 (pF)	C4 (pF)	R2 (kΩ)	R3 (kΩ)	R4 (kΩ)	Loop Filter Design
[3]	470	10	82	82	0.51	1	1	
[4]	120	2.7	33	33	0.91	2	2	
[5]	330	10	180	180	0.75	1	1	
[6]	120	4.7	33	33	1.3	2	2	

## FRACTIONAL-N PLL WITH INTEGRATED VCO 1310 - 1415, 2620 - 2830, 5240 - 5660 MHz

**Closed Loop Integer Phase Noise**

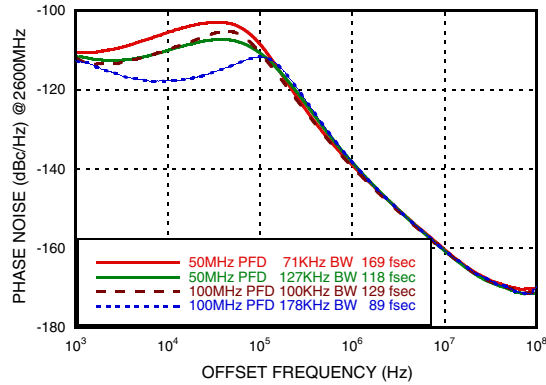

**Typical Closed Loop Fractional Phase Noise [1]**

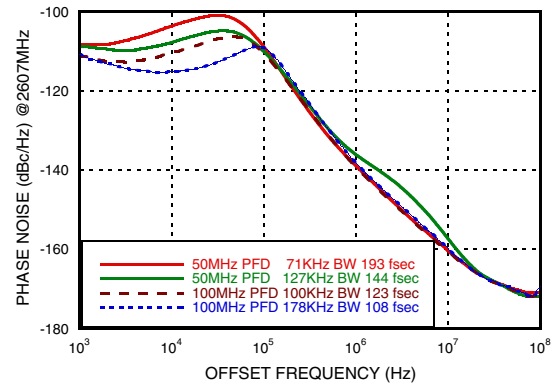

**Free Running Phase Noise**

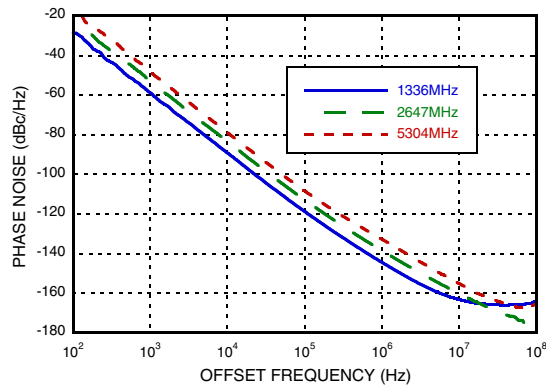

**Typical Tuning Curves vs. Switch Position**

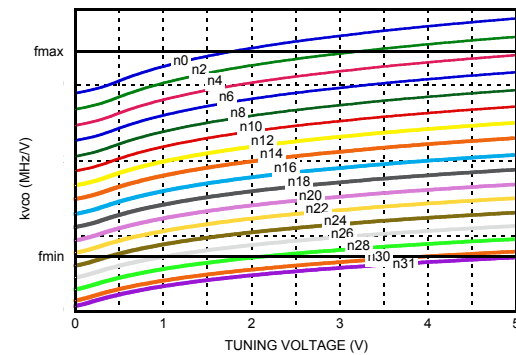

**Free Running VCO Phase Noise Over Temperature**

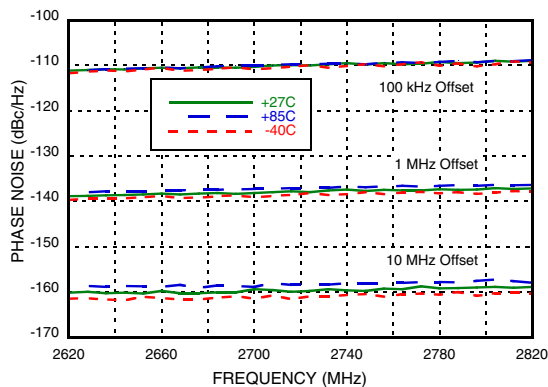

**Typical VCO Tuning Voltage After Calibration**

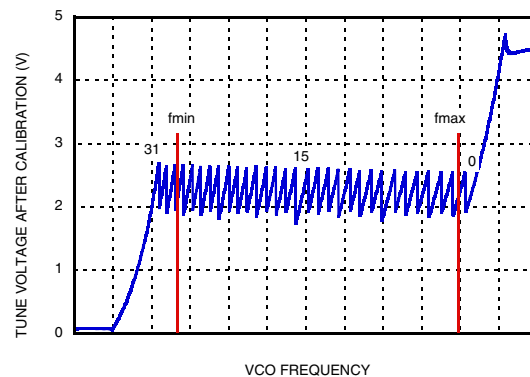

[1] RMS Jitter data is measured from 10KHz to 100MHz bandwidth.

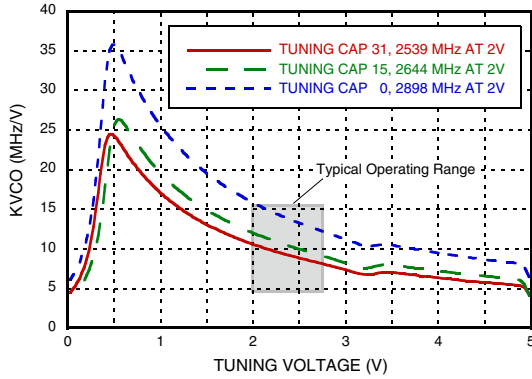
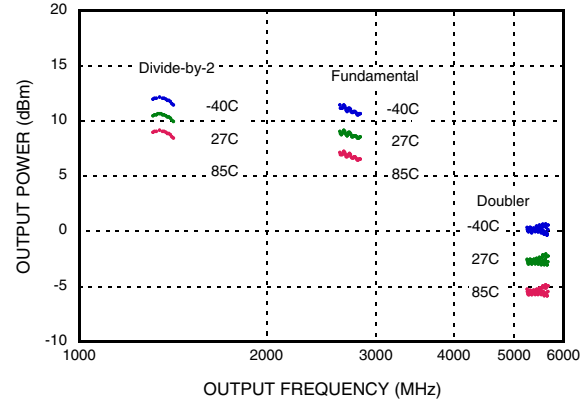
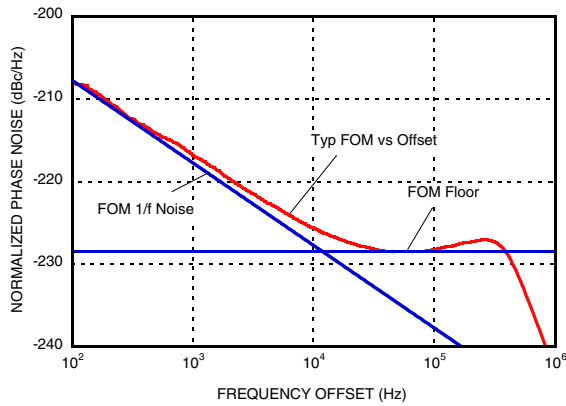
**FRACTIONAL-N PLL WITH INTEGRATED VCO**  
**1310 - 1415, 2620 - 2830, 5240 - 5660 MHz**
**Typical VCO Sensitivity vs. Cap @ Fo Voltage**

**Typical Output Power - Narrow Band Match**

**Figure of Merit**





**FRACTIONAL-N PLL WITH INTEGRATED VCO  
1310 - 1415, 2620 - 2830, 5240 - 5660 MHz**
**Pin Descriptions**

Pin Number	Function	Description
1	AVDD	DC Power Supply for analog circuitry.
2, 5, 6, 8, 9, 11 - 14, 18 - 22, 24, 26, 34, 37, 38	N/C	The pins are not connected internally; however, all data shown herein was measured with these pins connected to RF/DC ground externally.
3	VPPCP	Power Supply for charge pump analog section
4	CP	Charge Pump Output
7	VDDCP	Power Supply for the charge pump digital section
10	RVDD	Reference Supply
15	XREFP	Reference Oscillator Input
16	DVDD3V	DC Power Supply for Digital (CMOS) Circuitry
17	CEN	Chip Enable. Connect to logic high for normal operation.
23	VTUNE	VCO Varactor. Tuning Port Input.
25	VCC2	VCO Analog Supply 2
27	VCC1	VCO Analog Supply 1
28	RF_N <sup>[1]</sup>	RF Positive Output
29	RF_P <sup>[1]</sup>	RF Negative Output
30	SEN	PLL Serial Port Enable (CMOS) Logic Input
31	SDI	PLL Serial Port Data (CMOS) Logic Input
32	SCK	PLL Serial Port Clock (CMOS) Logic Input
33	LD_SDO	Lock Detect, or Serial Data, or General Purpose (CMOS) Logic Output (GPO)
35	VCCHF	DC Power Supply for Analog Circuitry
36	VCCPS	DC Power Supply for Analog Prescaler
39	VCCPD	DC Power Supply for Phase Detector
40	BIAS	External bypass decoupling for precision bias circuits. Note: 1.920V $\pm$ 20mV reference voltage (BIAS) is generated internally and cannot drive an external load. Must be measured with 10G $\Omega$ meter such as Agilent 34410A, normal 10M $\Omega$ DVM will read erroneously.

[1] For doubler mode of operation, pin 28 (RF\_N) and pin 29 (RF\_P) outputs must be shorted together.



## FRACTIONAL-N PLL WITH INTEGRATED VCO

### 1310 - 1415, 2620 - 2830, 5240 - 5660 MHz

### Absolute Maximum Ratings

AVDD, RVDD, DVDD3V, VCCPD, VCCHF, VCCPS	-0.3V to +3.6V
VPPCP, VDDCP, VCC1	-0.3V to +5.8V
VCC2	-0.3V to +5.5V
Operating Temperature	-40°C to +85°C
Storage Temperature	-65°C to 125°C
Maximum Junction Temperature	125 °C
Thermal Resistance (R <sub>TH</sub> ) (junction to ground paddle)	20 °C/W
Reflow Soldering	
Peak Temperature	260°C
Time at Peak Temperature	40 sec
ESD Sensitivity (HBM)	Class 1B

Stresses above those listed under Absolute Maximum Ratings may cause permanent damage to the device. This is a stress rating only; functional operation of the device at these or any other conditions above those indicated in the operational section of this specification is not implied. Exposure to absolute maximum rating conditions for extended periods may affect device reliability.

### Outline Drawing

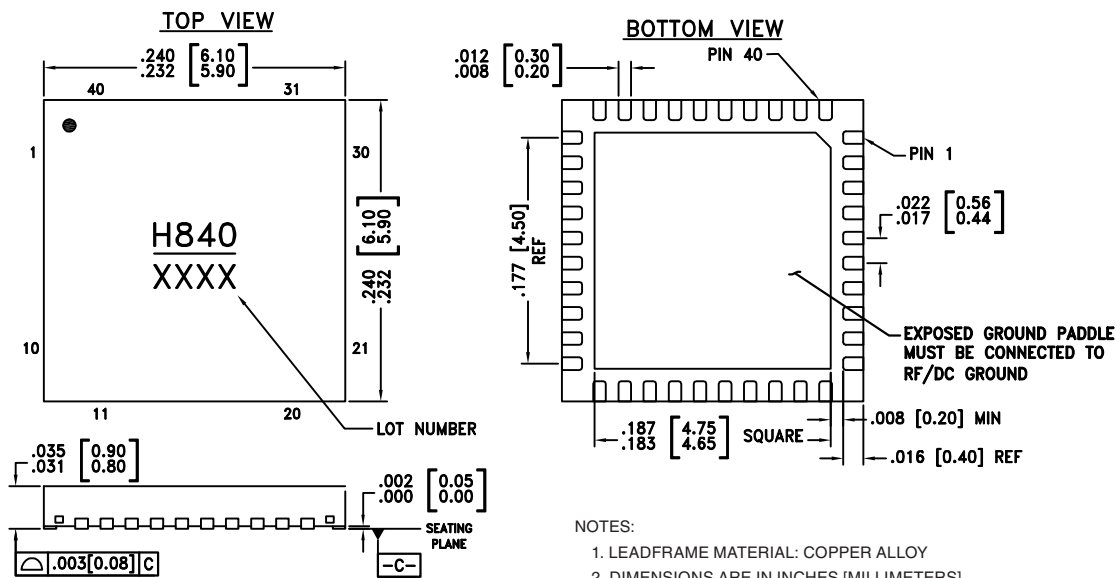

### Package Information

Part Number	Package Body Material	Lead Finish	MSL Rating	Package Marking <sup>[1]</sup>
HMC840LP6CE	RoHS-compliant Low Stress Injection Molded Plastic	100% matte Sn	MSL1	H840 XXXX

[1] 4-Digit lot number XXXX

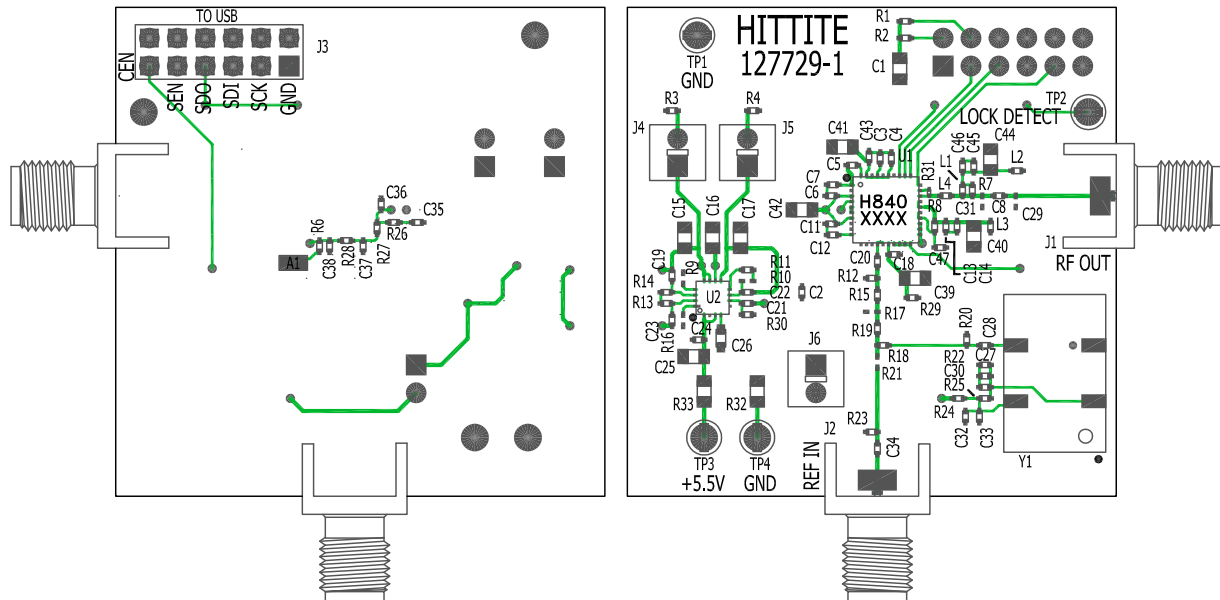
**Evaluation PCB**

The circuit board used in the application should use RF circuit design techniques. Signal lines should have 50 Ohm impedance while the package ground leads and exposed paddle should be connected directly to the ground plane similar to that shown. A sufficient number of via holes should be used to connect the top and bottom ground planes. The evaluation circuit board shown is available from Hittite upon request.

**Evaluation PCB Schematic**

To view this [Evaluation PCB Schematic](http://www.hittite.com) please visit [www.hittite.com](http://www.hittite.com) and choose HMC840LP6CE from the "Search by Part Number" pull down menu to view the product splash page.

**Evaluation Order Information**

Item	Contents	Part Number
Evaluation PCB Only	HMC840LP6CE $F_o/2$ & $F_o$ Evaluation PCB	129515-HMC840LP6CE
	HMC840LP6CE $2xF_o$ Evaluation PCB	129516-HMC840LP6CE
Evaluation Kit	HMC840LP6CE $F_o/2$ & $F_o$ Evaluation PCB USB Interface Board 6' USB A Male to USB B Female Cable CD ROM (Contains User Manual, Evaluation PCB Schematic, Evaluation Software, Hittite PLL Design Software)	129075-HMC840LP6CE
	HMC840LP6CE $2xF_o$ Evaluation PCB USB Interface Board 6' USB A Male to USB B Female Cable CD ROM (Contains User Manual, Evaluation PCB Schematic, Evaluation Software, Hittite PLL Design Software)	129076-HMC840LP6CE



MICROWAVE CORPORATION v00.1210



# HMC840LP6CE

**FRACTIONAL-N PLL WITH INTEGRATED VCO**  
**1310 - 1415, 2620 - 2830, 5240 - 5660 MHz**

**Notes:**