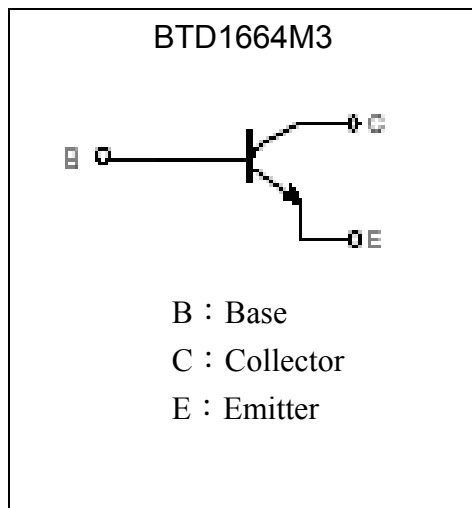
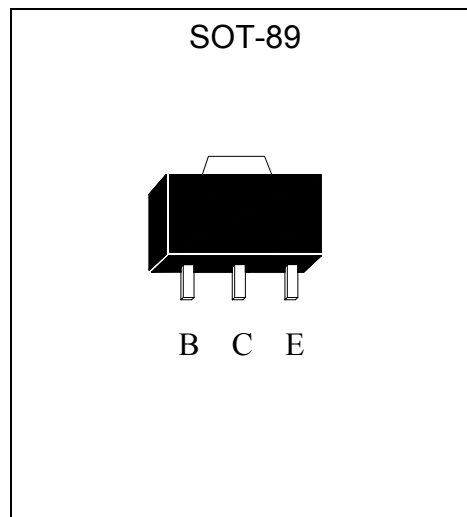

Low Vcesat NPN Epitaxial Planar Transistor

BTD1664M3

Features

- The BTD1664M3 is designed for general purpose low frequency power amplifier applications.
- Low $V_{CE(sat)}$, $V_{CE(sat)}=0.15V$ (typical), at $I_C / I_B = 400mA / 20mA$
- Complementary to BTB1132M3

Symbol

Outline

Absolute Maximum Ratings ($T_a=25^{\circ}C$)

Parameter	Symbol	Limits	Unit
Collector-Base Voltage	V_{CB0}	40	V
Collector-Emitter Voltage	V_{CEO}	20	V
Emitter-Base Voltage	V_{EB0}	5	V
Collector Current (DC)	I_C	800	mA
Collector Current (Pulse)	I_{CP}	1.5 (Note 1)	A
Power Dissipation	P_d	0.5	W
Power Dissipation	P_d	2 (Note 2)	W
Junction Temperature	T_j	150	$^{\circ}C$
Storage Temperature	T_{stg}	-55~+150	$^{\circ}C$

Note : 1. Single pulse, $P_w = 20ms$, duty $\leq 2\%$.

2. When mounted on a 40 × 40 × 0.7 mm ceramic board.



Characteristics (Ta=25°C)

Symbol	Min.	Typ.	Max.	Unit	Test Conditions
BV _{CBO}	40	-	-	V	I _C =10μA, I _E =0
BV _{CEO}	20	-	-	V	I _C =1mA, I _B =0
BV _{EBO}	5	-	-	V	I _E =10μA, I _C =0
I _{CBO}	-	-	0.5	μA	V _{CB} =20V, I _E =0
I _{EBO}	-	-	0.5	μA	V _{EB} =4V, I _C =0
*V _{CE(sat)1}	-	0.15	0.3	V	I _C =400mA, I _B =20mA
*V _{CE(sat)2}	-	0.2	0.4	V	I _C =500mA, I _B =50mA
*V _{CE(sat)3}	-	0.25	0.5	V	I _C =800mA, I _B =80mA
*V _{BE(on)}	-	-	1	V	V _{CE} =2V, I _C =500mA
*h _{FE1}	82	-	560	-	V _{CE} =2V, I _C =100mA
*h _{FE2}	82	-	560	-	V _{CE} =2V, I _C =500mA
*h _{FE3}	80	-	-	-	V _{CE} =2V, I _C =800mA
f _T	-	150	-	MHZ	V _{CE} =5V, I _E =50mA, f=100MHZ
Cob	-	15	-	pF	V _{CB} =10V, f=1MHZ

*Pulse Test : Pulse Width ≤380us, Duty Cycle ≤2%

Classification Of hFE2

Rank	P	Q	R	S
Range	82~180	120~270	180~390	270~560

Characteristic Curves

Current Gain vs Collector Current

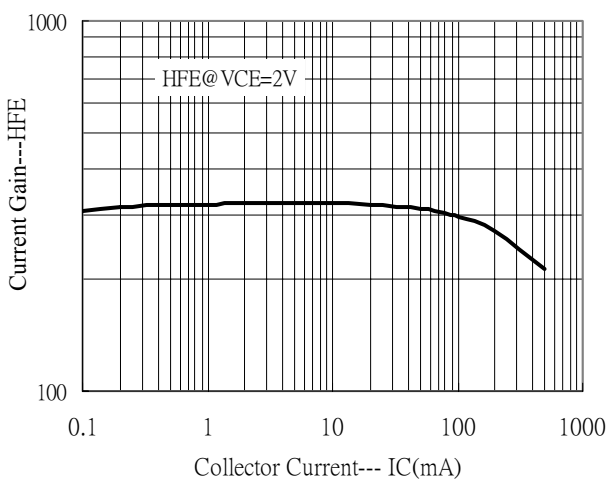

Saturation Voltage vs Collector Current

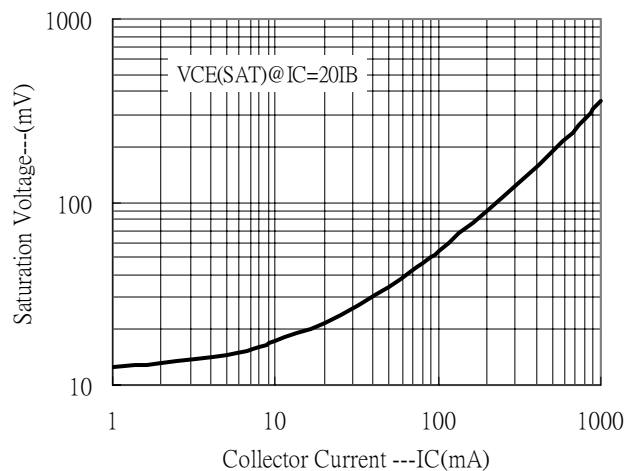



Saturation Voltage vs Collector Current

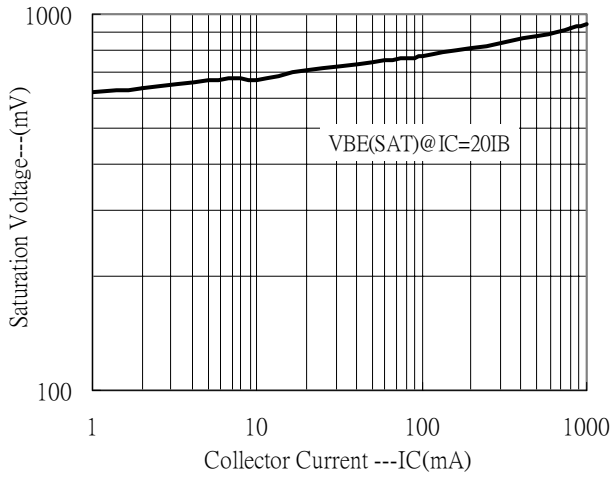

Cutoff Frequency vs Collector Current

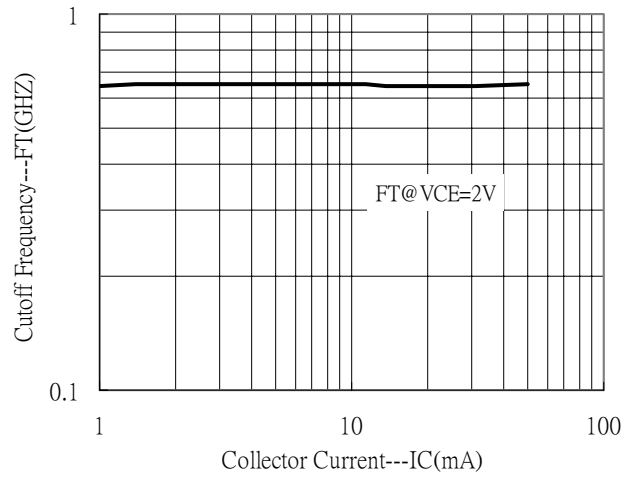

Power Derating Curve

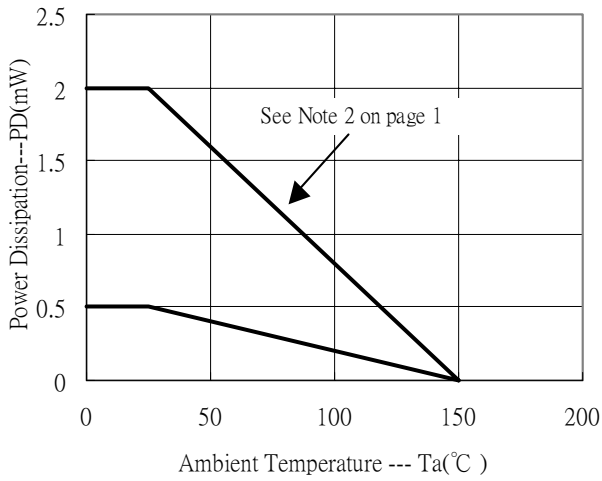

SOT-89 Dimension

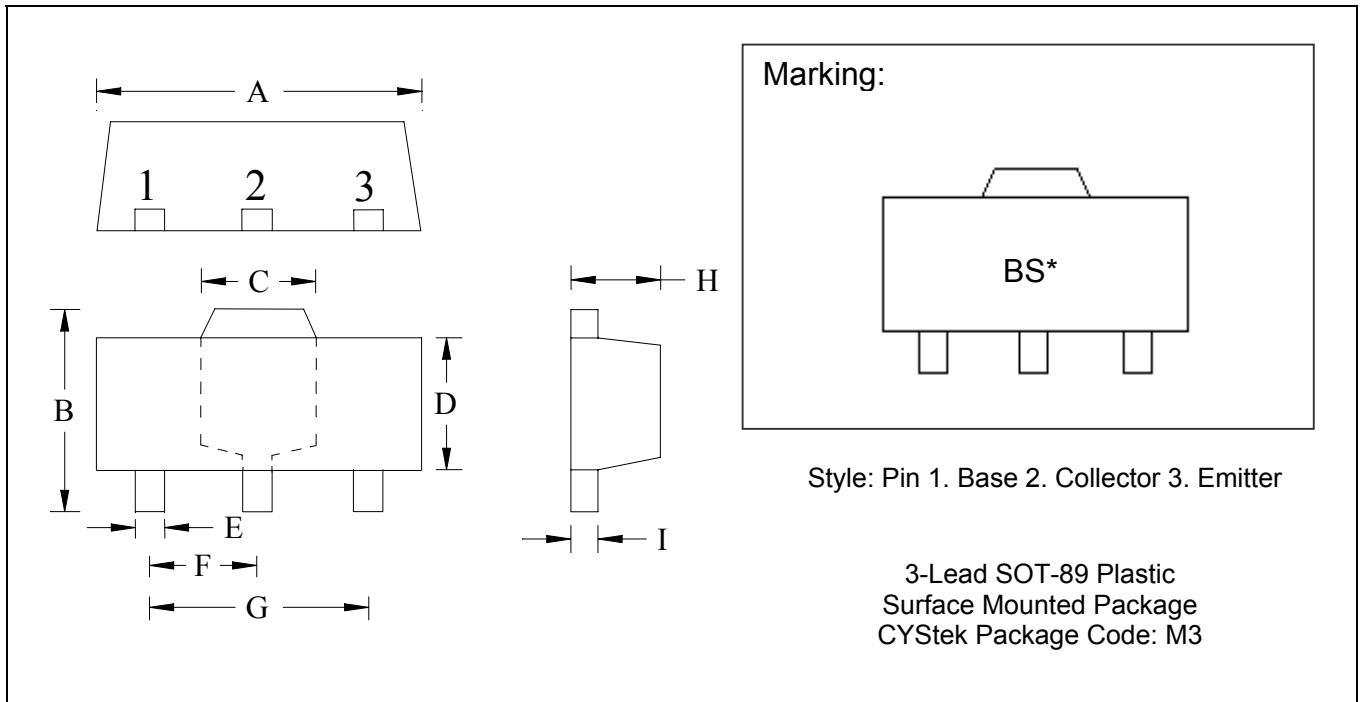

*: Typical

DIM	Inches		Millimeters		DIM	Inches		Millimeters	
	Min.	Max.	Min.	Max.		Min.	Max.	Min.	Max.
A	0.1732	0.1811	4.40	4.60	F	0.0583	0.0598	1.48	1.527
B	0.1594	0.1673	4.05	4.25	G	0.1165	0.1197	2.96	3.04
C	0.0591	0.0663	1.50	1.70	H	0.0551	0.0630	1.40	1.60
D	0.0945	0.1024	2.40	2.60	I	0.0138	0.0161	0.35	0.41
E	0.01417	0.0201	0.36	0.51					

- Notes: 1.Controlling dimension: millimeters.
 2.Maximum lead thickness includes lead finish thickness, and minimum lead thickness is the minimum thickness of base material.
 3.If there is any question with packing specification or packing method, please contact your local CYStek sales office.

Material:

- Lead: 42 Alloy ; solder plating
- Mold Compound: Epoxy resin family, flammability solid burning class: UL94V-0

Important Notice:

- All rights are reserved. Reproduction in whole or in part is prohibited without the prior written approval of CYStek.
- CYStek reserves the right to make changes to its products without notice.
- CYStek **semiconductor products are not warranted to be suitable for use in Life-Support Applications, or systems.**
- CYStek assumes no liability for any consequence of customer product design, infringement of patents, or application assistance.