

Silicon NPN Power Transistors

2SD669 2SD669A

DESCRIPTION

www.datasheet4u.com

- With TO-126 package
- Complement to type 2SB649/649A
- High breakdown voltage V_{CE0} :120/160V
- High current 1.5A
- Low saturation voltage,excellent h_{FE} linearity

APPLICATIONS

- For low-frequency power amplifier applications

PINNING

PIN	DESCRIPTION
1	Emitter
2	Collector;connected to mounting base
3	Base

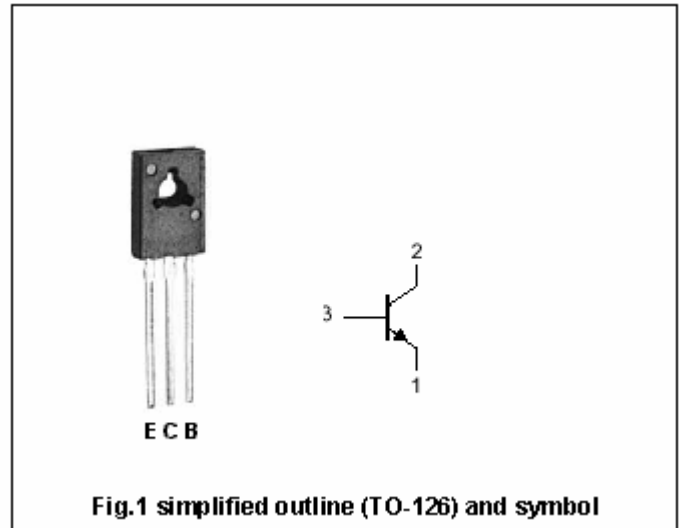
Absolute maximum ratings($T_a=25^\circ$)

SYMBOL	PARAMETER	CONDITIONS	VALUE	UNIT
V_{CBO}	Collector-base voltage	2SD669	180	V
		2SD669A	180	
V_{CEO}	Collector-emitter voltage	2SD669	120	V
		2SD669A	160	
V_{EBO}	Emitter-base voltage	Open collector	5	V
I_C	Collector current (DC)		1.5	A
I_{CM}	Collector current-peak		3	A
P_D	Total power dissipation	$T_a=25^\circ$	1	W
		$T_C=25^\circ$	20	
T_j	Junction temperature		150	$^\circ$
T_{stg}	Storage temperature		-55~150	$^\circ$

Silicon NPN Power Transistors

2SD669 2SD669A

CHARACTERISTICS

T_j=25 °C unless otherwise specified

www.datasheet4u.com

SYMBOL	PARAMETER	CONDITIONS	MIN	TYP.	MAX	UNIT	
V _{(BR)CEO}	Collector-emitter breakdown voltage	2SD669	I _C =10mA; R _{BE} =∞	120			V
		2SD669A		160			
V _{(BR)CBO}	Collector-base breakdown voltage	2SD669	I _C =1mA; I _E =0	180			V
		2SD669A		180			
V _{(BR)EBO}	Emitter-base breakdown voltage	I _E =1mA; I _C =0	5			V	
V _{CEsat}	Collector-emitter saturation voltage	I _C =0.5A; I _B =50mA			1.0	V	
V _{BE}	Base-emitter on voltage	I _C =150mA; V _{CE} =5V			1.5	V	
I _{CBO}	Collector cut-off current	V _{CB} =160V; I _E =0			10	μA	
h _{FE-1}	DC current gain	2SD669	I _C =150mA; V _{CE} =5V	60		320	
		2SD669A		60	200		
h _{FE-2}	DC current gain	I _C =0.5A; V _{CE} =5V	30				
f _T	Transition frequency	I _C =150mA; V _{CE} =5V		140		MHz	
C _{OB}	Collector output capacitance	f=1MHz; V _{CB} =10V		14		pF	

◆ h_{FE} Classifications

h _{FE-1}	B	C	D
2SB649	60-120	100-200	160-320
2SB649A	60-120	100-200	

PACKAGE OUTLINE

www.datasheet4u.com

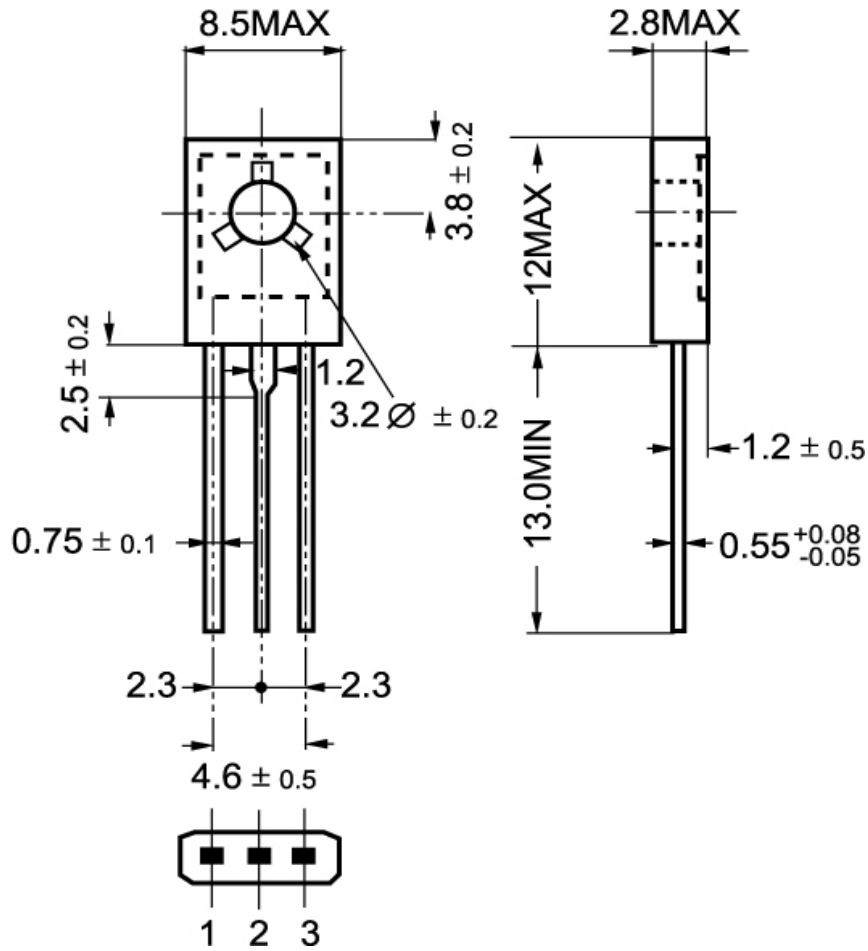
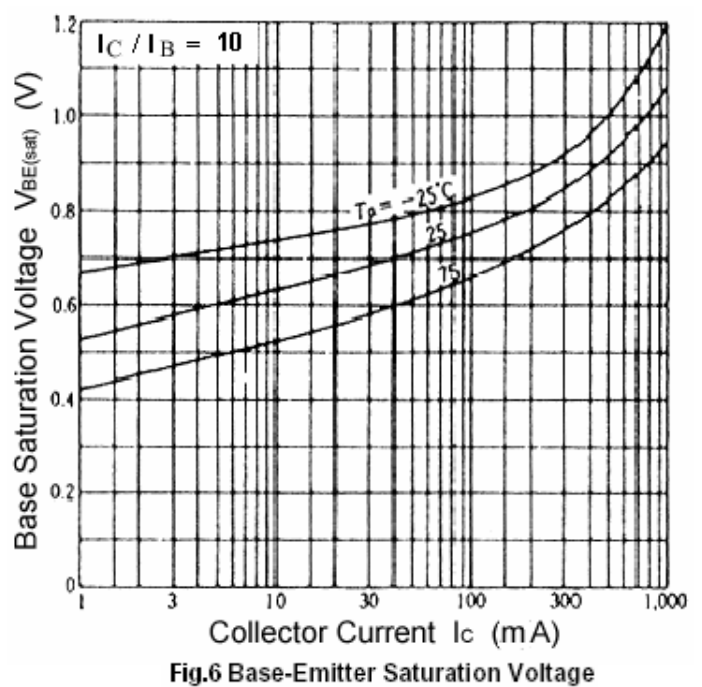
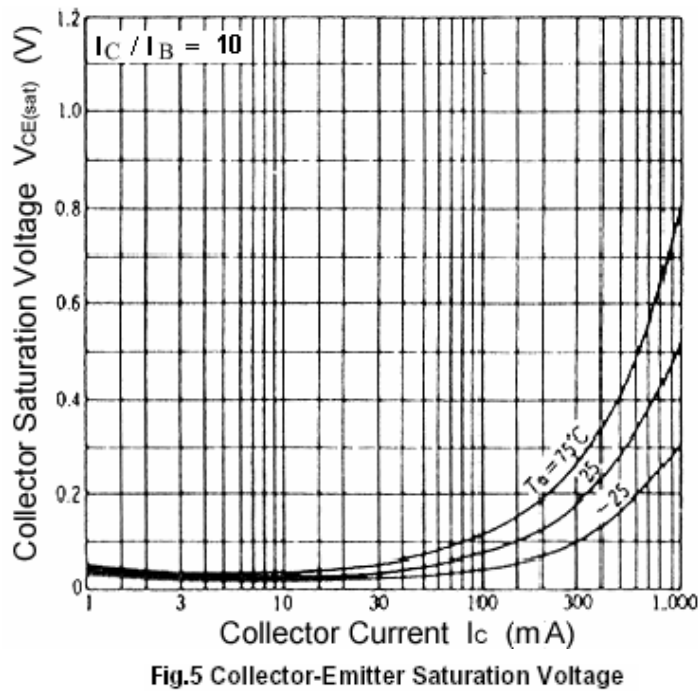
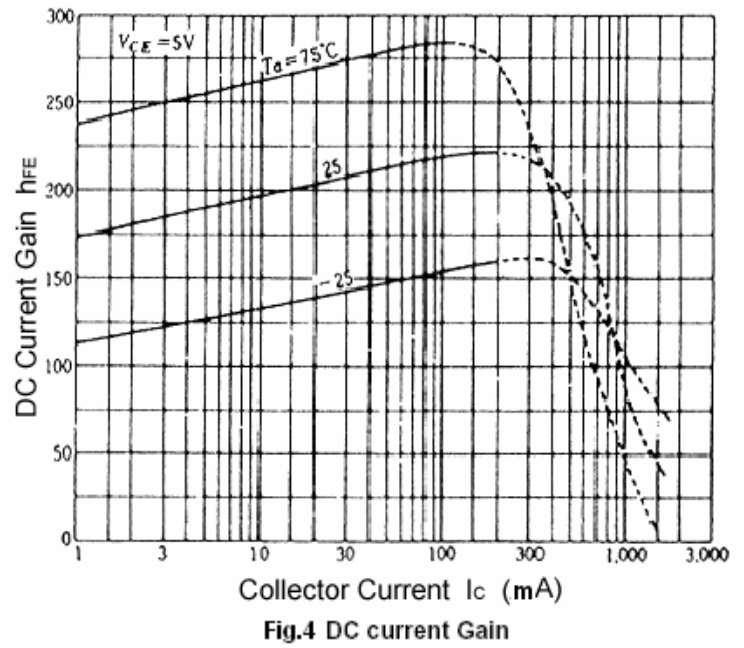
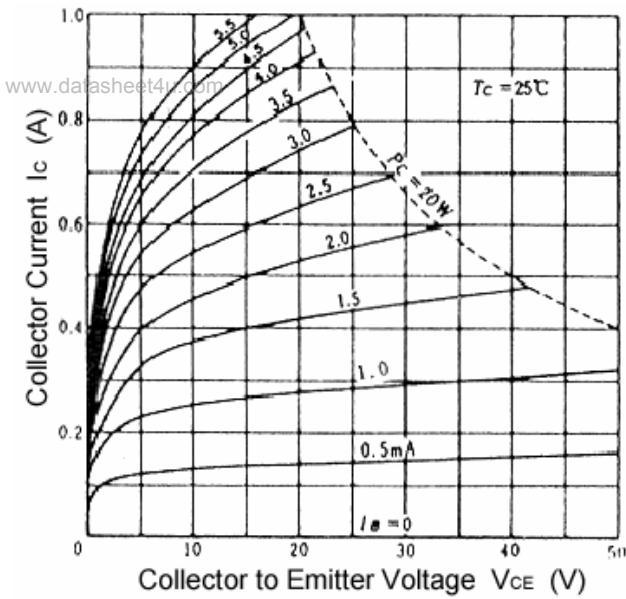

Fig.2 Outline dimensions

Silicon NPN Power Transistors

2SD669 2SD669A



Silicon NPN Power Transistors

2SD669 2SD669A

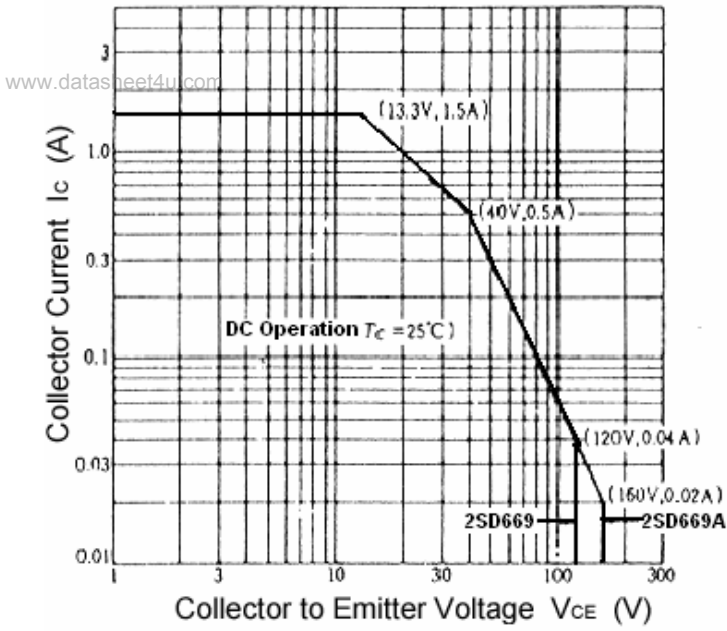

Fig.7 Safe Operating Area