



STU/D6025NL

N-Channel Logic Level Enhancement Mode Field Effect Transistor

PRODUCT SUMMARY

V _{DS}	I _D	R _{DS(ON)} (mΩ) Typ
30V	60A	5.5 @ V _{GS} = 10V
		8 @ V _{GS} = 4.5V

FEATURES

- Super high dense cell design for low R_{DS(ON)}.
- Rugged and reliable.
- TO-252 and TO-251 Package.

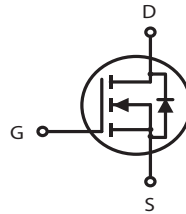

ABSOLUTE MAXIMUM RATINGS (T_A=25°C unless otherwise noted)

Parameter	Symbol	Limit	Unit
Drain-Source Voltage	V _{DS}	30	V
Gate-Source Voltage	V _{GS}	±20	V
Drain Current-Continuous ^a @ T _c =25°C -Pulsed ^b	I _D	60	A
	I _{DM}	100	A
Drain-Source Diode Forward Current	I _S	20	A
Maximum Power Dissipation @ T _c =25°C	P _D	50	W
Operating and Storage Temperature Range	T _J , T _{STG}	-55 to 175	°C

THERMAL CHARACTERISTICS

Thermal Resistance, Junction-to-Case	R _{θJC}	3	°C/W
Thermal Resistance, Junction-to-Ambient	R _{θJA}	50	°C/W

STU/D6025NL

ELECTRICAL CHARACTERISTICS (T_A=25 °C unless otherwise noted)

Parameter	Symbol	Condition	Min	Typ ^c	Max	Unit
OFF CHARACTERISTICS						
Drain-Source Breakdown Voltage	BV _{DSS}	V _{GS} =0V, I _D =250uA	30			V
Zero Gate Voltage Drain Current	I _{DSS}	V _{DS} =24V, V _{GS} =0V			1	uA
Gate-Body Leakage	I _{GSS}	V _{GS} = ± 20V, V _{DS} =0V			±100	nA
ON CHARACTERISTICS^b						
Gate Threshold Voltage	V _{GS(th)}	V _{DS} =V _{GS} , I _D = 250uA	1	1.6	3	V
Drain-Source On-State Resistance	R _{DS(ON)}	V _{GS} =10V, I _D =14A		5.5	7	m ohm
		V _{GS} =4.5V, I _D = 10A		8	10	m ohm
On-State Drain Current	I _{D(ON)}	V _{DS} = 10V, V _{GS} = 10V	85			A
Forward Transconductance	g _{FS}	V _{DS} = 10V, I _D = 14A		24.5		S
DYNAMIC CHARACTERISTICS^c						
Input Capacitance	C _{ISS}	V _{DS} =15V, V _{GS} = 0V f=1.0MHz		3270		pF
Output Capacitance	C _{OSS}			590		pF
Reverse Transfer Capacitance	C _{RSS}			420		pF
SWITCHING CHARACTERISTICS^c						
Turn-On Delay Time	t _{D(ON)}	V _{DD} = 15V I _D = 1A V _{GS} = 10V R _{GEN} = 6 ohm		37.3		ns
Rise Time	t _r			65.6		ns
Turn-Off Delay Time	t _{D(OFF)}			94.7		ns
Fall Time	t _f			44.5		ns
Total Gate Charge	Q _g	V _{DS} =15V, I _D =14A, V _{GS} =10V		59.6		nC
		V _{DS} =15V, I _D =14A, V _{GS} =4.5V		28.3		nC
Gate-Source Charge	Q _{gs}	V _{DS} = 15V, I _D =14A		8.5		nC
Gate-Drain Charge	Q _{gd}	V _{GS} = 10V		12.6		nC

STU/D6025NL

ELECTRICAL CHARACTERISTICS ($T_c=25^{\circ}\text{C}$ unless otherwise noted)

Parameter	Symbol	Condition	Min	Typ	Max	Unit
DRAIN-SOURCE DIODE CHARACTERISTICS ^a						
Diode Forward Voltage	V_{SD}	$V_{GS} = 0V, I_s = 20A$		0.86	1.3	V

Notes

- a. Surface Mounted on FR4 Board, $t \leq 10\text{sec}$.
- b. Pulse Test: Pulse Width $\leq 300\mu\text{s}$, Duty Cycle $\leq 2\%$.
- c. Guaranteed by design, not subject to production testing.

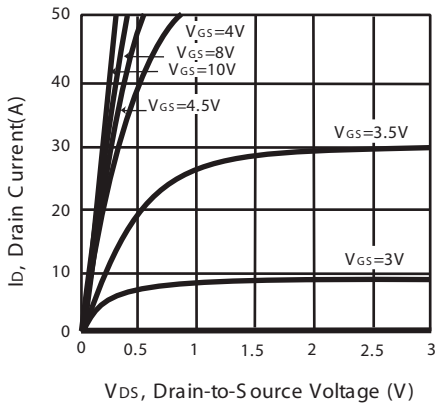

Figure 1. Output Characteristics

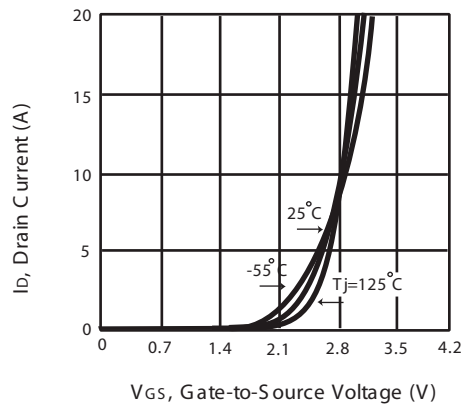

Figure 2. Transfer Characteristics

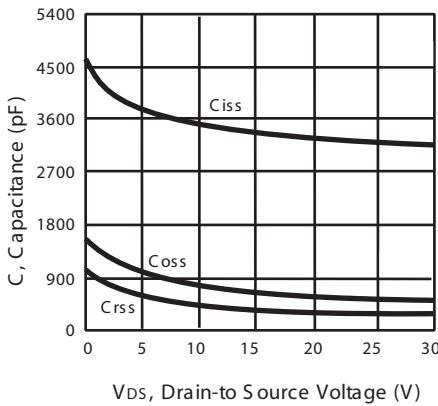

Figure 3. Capacitance

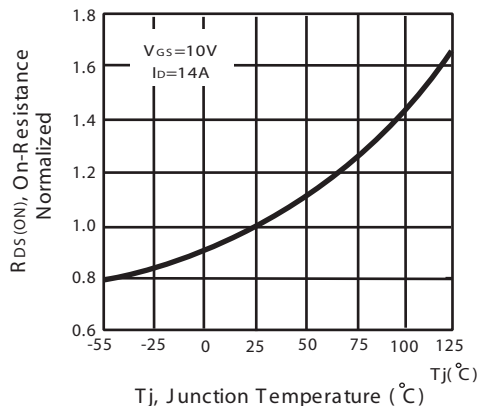

Figure 4. On-Resistance Variation with Drain Current and Temperature

STU/D6025NL

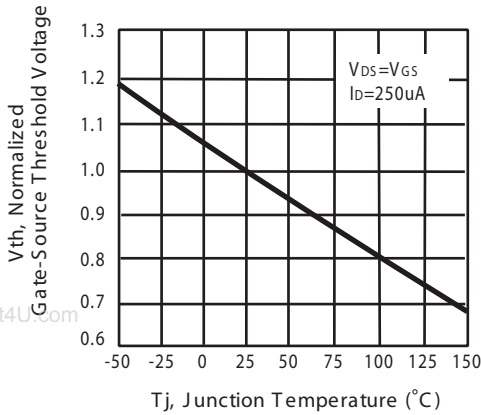

Figure 5. Gate Threshold Variation with Temperature

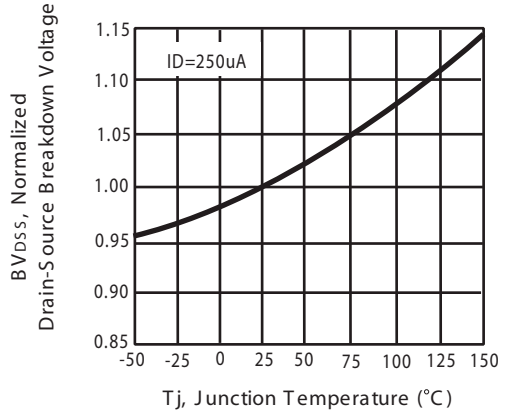

Figure 6. Breakdown Voltage Variation with Temperature

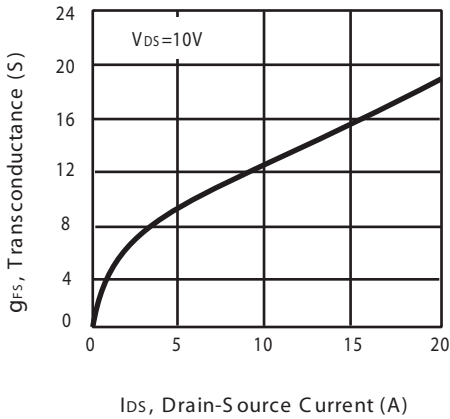

Figure 7. Transconductance Variation with Drain Current

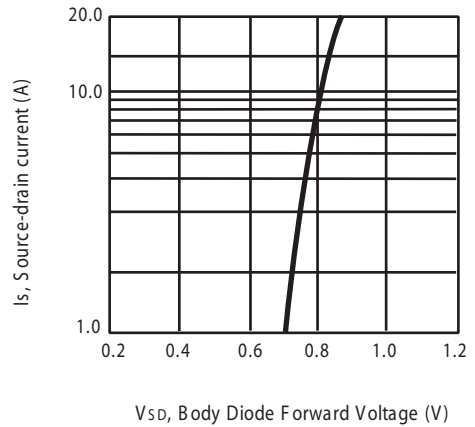

Figure 8. Body Diode Forward Voltage Variation with Source Current

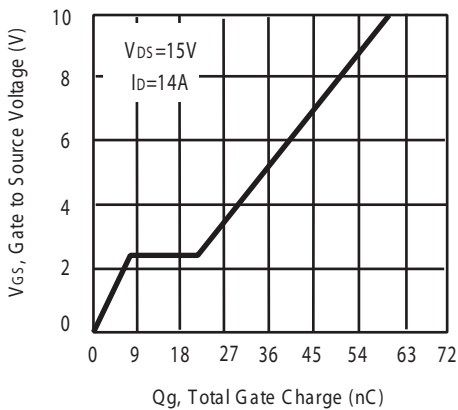

Figure 9. Gate Charge

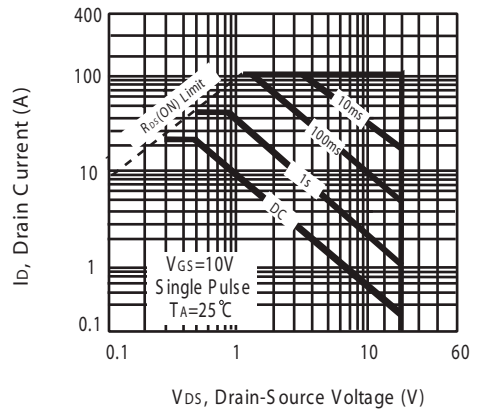

Figure 10. Maximum Safe Operating Area

STU/D6025NL

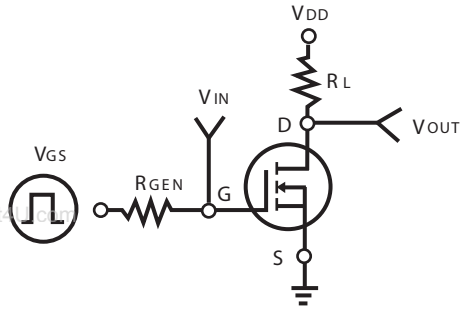

Figure 11. Switching Test Circuit

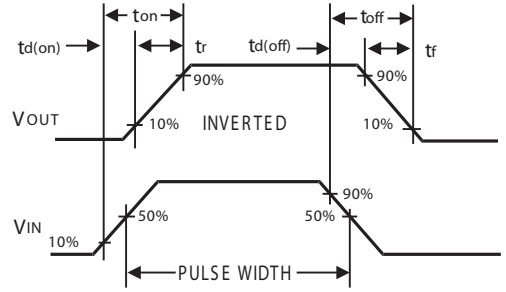
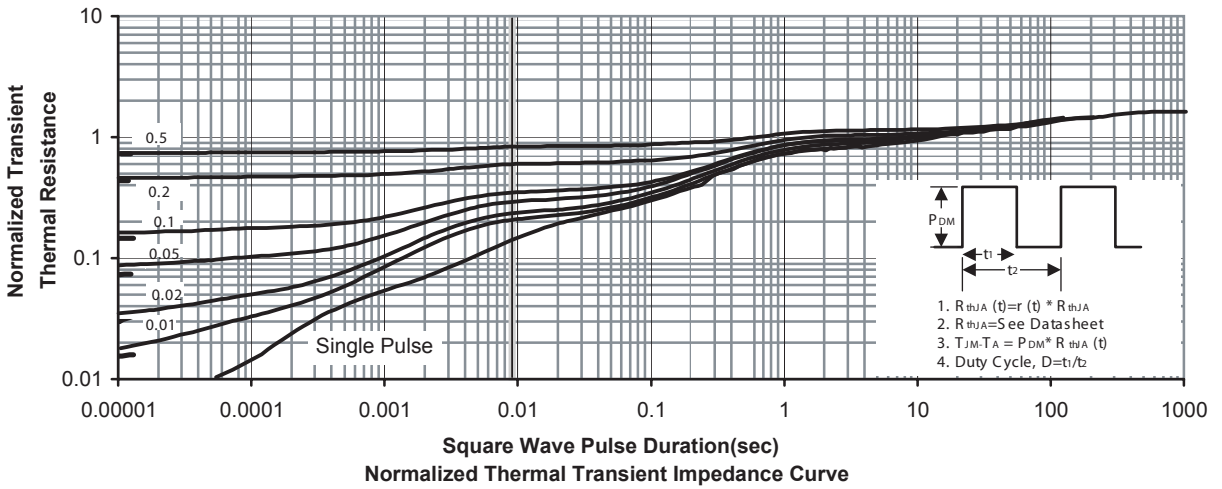

Figure 12. Switching Waveforms



STU/D6025NL

PACKAGE OUTLINE DIMENSIONS

TO-251

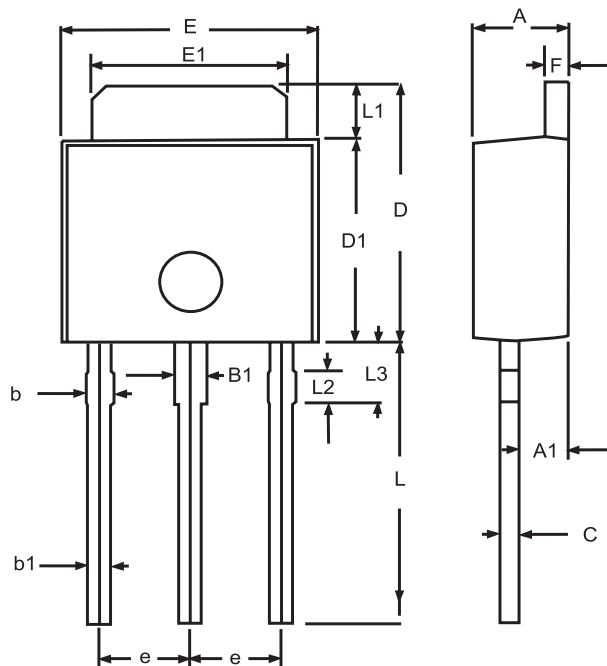

SYMBOLS	MILLIMETERS		INCHES	
	MIN	MAX	MIN	MAX
A	2.20	2.40	0.087	0.095
A1	1.100	1.300	0.043	0.051
B1	0.650	1.050	0.026	0.041
b	0.500	0.900	0.020	0.035
b1	0.400	0.800	0.016	0.32
C	0.400	0.600	0.016	0.024
D	6.700	7.300	0.264	0.287
D1	5.400	5.650	0.213	0.222
E	6.40	6.650	0.252	0.262
e	2.100	2.500	0.083	0.098
F	0.400	0.600	0.016	0.024
L	7.000	8.000	0.276	0.315
L1	1.300	1.700	0.051	0.067
L2	0.700	0.900	0.028	0.035
L3	1.400	1.800	0.055	0.071

STU/D6025NL

PACKAGE OUTLINE DIMENSIONS

TO-252

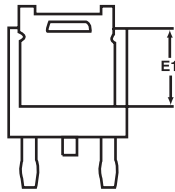
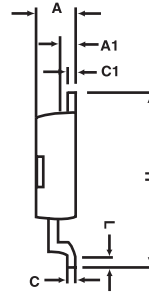
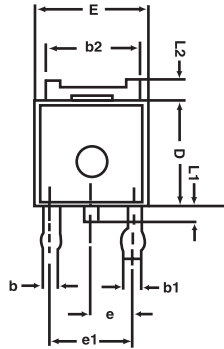

SYMBOLS	MILLIMETERS		INCHES	
	MIN	MAX	MIN	MAX
A	2.25	2.35	0.089	0.093
A1	0.95	1.05	0.037	0.041
b	0.77	0.85	0.030	0.033
b1	0.84	0.94	0.033	0.037
b2	5.30	5.45	0.209	0.215
C	0.49	0.53	0.019	0.021
D	6.00	6.20	0.236	0.244
E	6.40	6.60	0.252	0.260
E1	3.18	3.67	0.125	0.145
e	2.29	BSC	0.090	BSC
H	9.70	10.10	0.382	0.398
L	1.425	1.625	0.056	0.064
L1	0.650	0.850	0.026	0.033
L2	0.600	REF.	0.024	REF.

STU/D6025NL

TO251 Tube/TO-252 Tape and Reel Data

TO-251 Tube



TO-252 Carrier Tape



UNIT:mm

PACKAGE	A0	B0	K0	D0	D1	E	E1	E2	P0	P1	P2	T
TO-252 (16 mm)	6.80 ±0.1	10.3 ±0.1	2.50 ±0.1	φ 2	φ 1.5 + 0.1 - 0	16.0 0.3±	1.75 0.1±	7.5 ±0.15	8.0 ±0.1	4.0 ±0.1	2.0 ±0.15	0.3 ±0.05

TO-252 Reel



UNIT:mm

TAPE SIZE	REEL SIZE	M	N	W	T	H	K	S	G	R	V
16 mm	φ 330	φ 330 ± 0.5	φ 97 ± 1.0	17.0 + 1.5 - 0	2.2	φ 13.0 + 0.5 - 0.2	10.6	2.0 ± 0.5	---	---	---