



SANYO Semiconductors

DATA SHEET

55GN01CA

NPN Epitaxial Planar Silicon Transistor

UHF Wide-band Low-noise Amplifier Applications

Features

- High cutoff frequency : $f_T = 5.5\text{GHz}$ typ.
- High gain : $|S_{21e}|^2 = 9.5\text{dB}$ typ ($f = 1\text{GHz}$).

Specifications

Absolute Maximum Ratings at $T_a = 25^\circ\text{C}$

Parameter	Symbol	Conditions	Ratings	Unit
Collector-to-Base Voltage	V_{CBO}		20	V
Collector-to-Emitter Voltage	V_{CEO}		10	V
Emitter-to-Base Voltage	V_{EBO}		3	V
Collector Current	I_C		70	mA
Collector Dissipation	P_C		200	mW
Junction Temperature	T_j		150	$^\circ\text{C}$
Storage Temperature	T_{stg}		-55 to +150	$^\circ\text{C}$

Electrical Characteristics at $T_a = 25^\circ\text{C}$

Parameter	Symbol	Conditions	Ratings			Unit
			min	typ	max	
Collector Cutoff Current	I_{CBO}	$V_{CB} = 10\text{V}, I_E = 0\text{A}$			0.1	μA
Emitter Cutoff Current	I_{EBO}	$V_{EB} = 2\text{V}, I_C = 0\text{A}$			1	μA
DC Current Gain	h_{FE}	$V_{CE} = 5\text{V}, I_C = 10\text{mA}$	100		180	
Gain-Bandwidth Product	f_{T1}	$V_{CE} = 3\text{V}, I_C = 5\text{mA}$	3.0	4.5		GHz
	f_{T2}	$V_{CE} = 5\text{V}, I_C = 20\text{mA}$		5.5		GHz
Output Capacitance	C_{ob}	$V_{CB} = 10\text{V}, f = 1\text{MHz}$		1.1	1.3	pF
Reverse Transfer Capacitance	C_{re}	$V_{CB} = 10\text{V}, f = 1\text{MHz}$		0.7		pF
Forward Transfer Gain	$ S_{21e} ^2$	$V_{CE} = 5\text{V}, I_C = 20\text{mA}, f = 1\text{GHz}$	6.5	9.5		dB
Noise Figure	NF	$V_{CE} = 3\text{V}, I_C = 5\text{mA}, f = 1\text{GHz}, Z_S = Z_L = 50\Omega$		1.9		dB

Marking : ZW

■ Any and all SANYO Semiconductor Co.,Ltd. products described or contained herein are, with regard to "standard application", intended for the use as general electronics equipment (home appliances, AV equipment, communication device, office equipment, industrial equipment etc.). The products mentioned herein shall not be intended for use for any "special application" (medical equipment whose purpose is to sustain life, aerospace instrument, nuclear control device, burning appliances, transportation machine, traffic signal system, safety equipment etc.) that shall require extremely high level of reliability and can directly threaten human lives in case of failure or malfunction of the product or may cause harm to human bodies, nor shall they grant any guarantee thereof. If you should intend to use our products for applications outside the standard applications of our customer who is considering such use and/or outside the scope of our intended standard applications, please consult with us prior to the intended use. If there is no consultation or inquiry before the intended use, our customer shall be solely responsible for the use.

■ Specifications of any and all SANYO Semiconductor Co.,Ltd. products described or contained herein stipulate the performance, characteristics, and functions of the described products in the independent state, and are not guarantees of the performance, characteristics, and functions of the described products as mounted in the customer's products or equipment. To verify symptoms and states that cannot be evaluated in an independent device, the customer should always evaluate and test devices mounted in the customer's products or equipment.

SANYO Semiconductor Co., Ltd.

www.semiconductor-sanyo.com/network

Package Dimensions

unit : mm (typ)

7013A-009

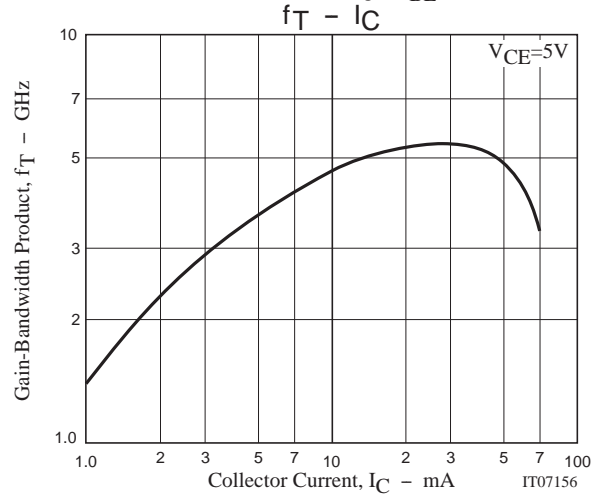
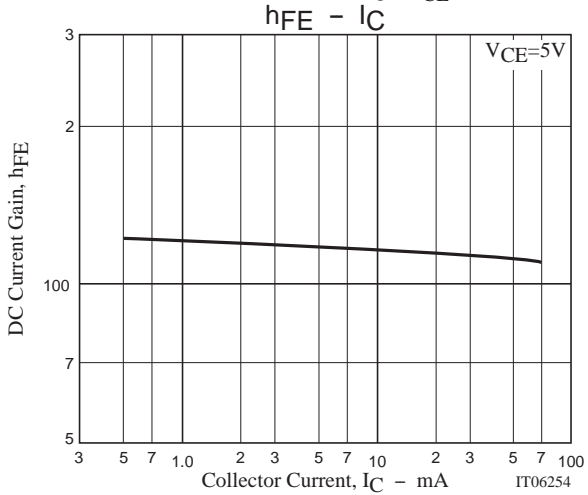
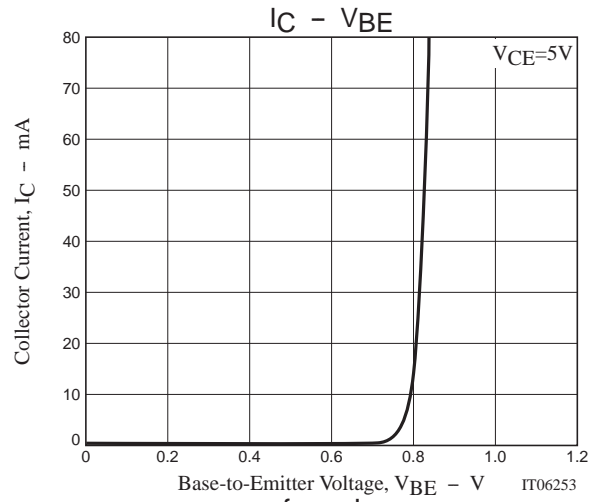
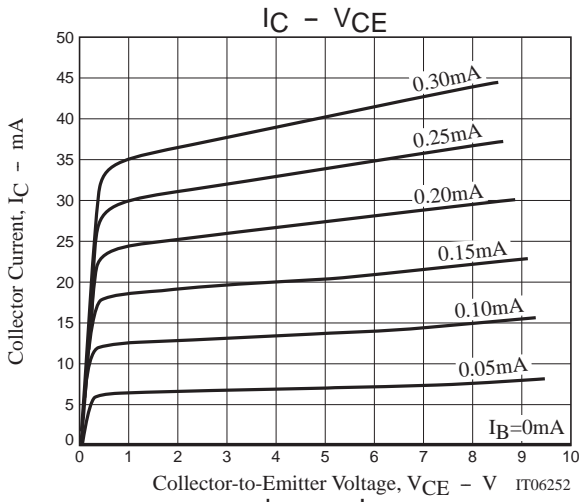
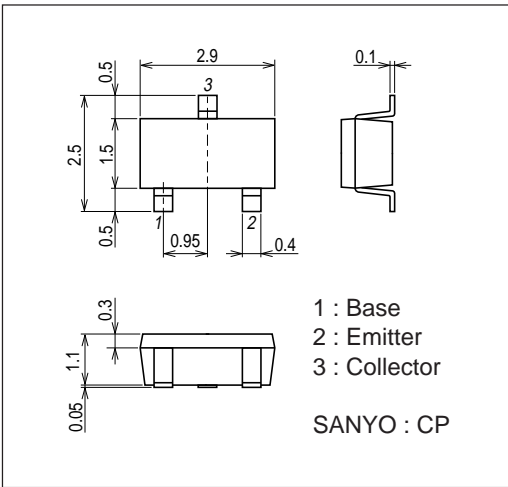

55GN01CA

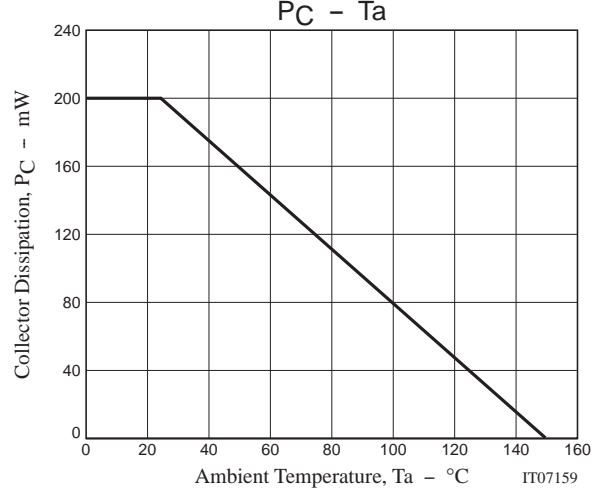
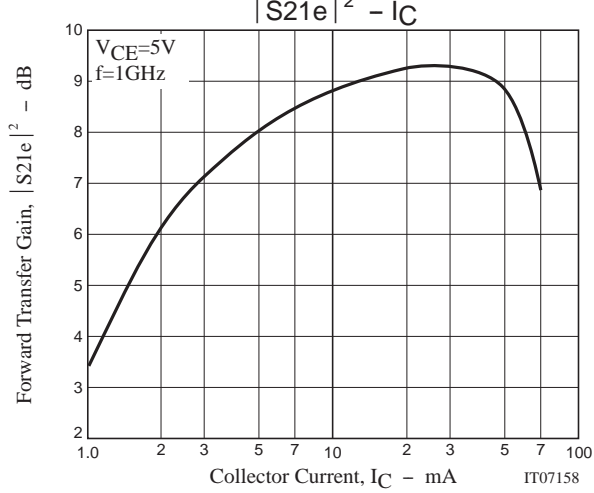
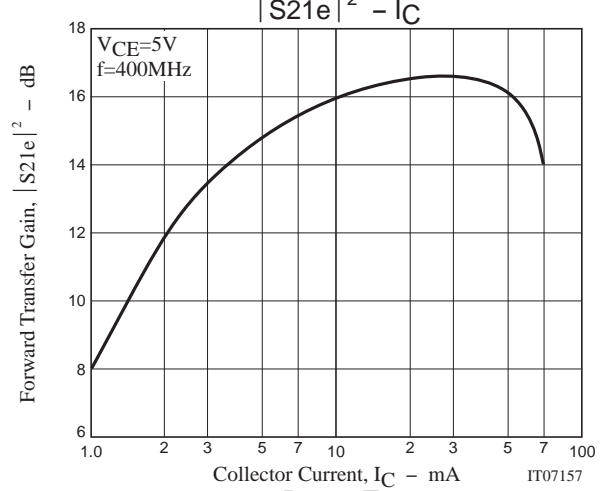
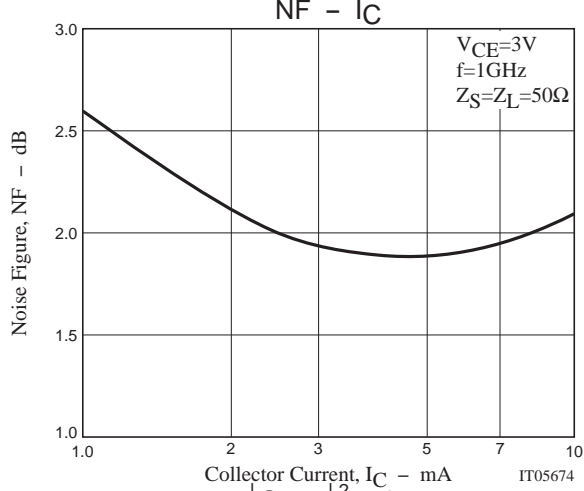
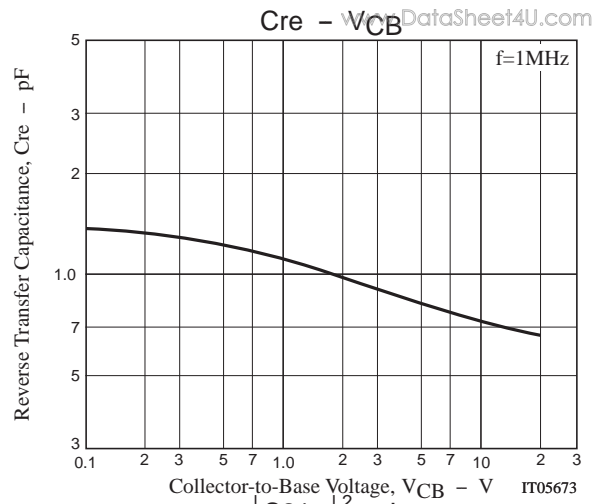
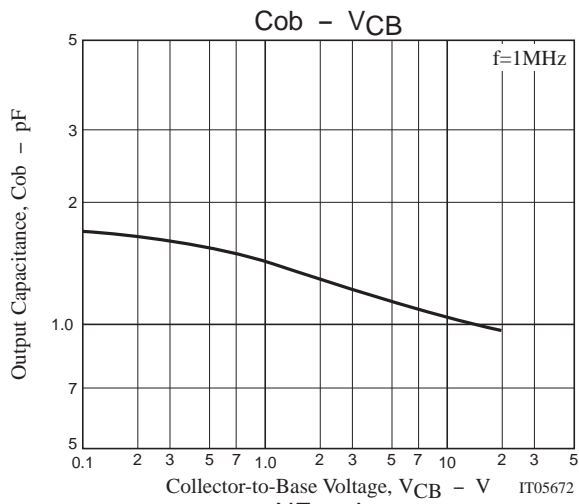

55GN01CA

S Parameters (Common emitter)

www.DataSheet4U.com

$V_{CE}=5V, I_C=1mA, Z_O=50\Omega$

Freq(MHz)	$ S_{11} $	$\angle S_{11}$	$ S_{21} $	$\angle S_{21}$	$ S_{12} $	$\angle S_{12}$	$ S_{22} $	$\angle S_{22}$
100	0.949	-22.44	3.333	161.77	0.051	76.83	0.974	-10.27
200	0.896	-42.53	3.106	145.66	0.096	64.91	0.926	-19.70
400	0.771	-76.67	2.521	119.93	0.149	47.18	0.801	-32.90
600	0.679	-102.20	2.043	101.07	0.167	38.13	0.714	-40.64
800	0.622	-122.03	1.712	86.82	0.169	34.45	0.661	-46.50
1000	0.585	-138.21	1.490	75.34	0.164	35.98	0.642	-51.94
1200	0.566	-152.02	1.321	65.79	0.158	41.97	0.633	-56.73
1400	0.555	-163.57	1.192	57.95	0.167	51.00	0.636	-62.43
1600	0.550	-173.92	1.101	51.64	0.189	57.12	0.653	-68.80
1800	0.545	176.42	1.027	45.83	0.209	64.08	0.665	-74.79
2000	0.543	167.94	0.963	41.62	0.262	70.03	0.683	-80.37

$V_{CE}=5V, I_C=3mA, Z_O=50\Omega$

Freq(MHz)	$ S_{11} $	$\angle S_{11}$	$ S_{21} $	$\angle S_{21}$	$ S_{12} $	$\angle S_{12}$	$ S_{22} $	$\angle S_{22}$
100	0.849	-36.58	8.604	151.45	0.047	69.52	0.908	-19.05
200	0.719	-65.72	7.078	130.50	0.077	58.46	0.768	-32.07
400	0.543	-104.50	4.701	105.14	0.109	49.29	0.576	-42.71
600	0.466	-128.63	3.425	90.40	0.126	50.26	0.500	-47.19
800	0.434	-145.01	2.697	79.88	0.141	53.53	0.463	-51.04
1000	0.417	-157.80	2.265	71.34	0.162	57.40	0.455	-55.89
1200	0.414	-167.96	1.951	63.80	0.183	60.44	0.454	-60.20
1400	0.415	-176.38	1.735	57.35	0.214	63.33	0.460	-65.55
1600	0.418	175.97	1.591	51.56	0.245	61.95	0.473	-71.92
1800	0.421	169.02	1.462	45.89	0.266	63.26	0.487	-77.11
2000	0.426	163.03	1.370	41.27	0.313	65.05	0.508	-81.84

$V_{CE}=5V, I_C=5mA, Z_O=50\Omega$

Freq(MHz)	$ S_{11} $	$\angle S_{11}$	$ S_{21} $	$\angle S_{21}$	$ S_{12} $	$\angle S_{12}$	$ S_{22} $	$\angle S_{22}$
100	0.765	-46.98	12.335	143.95	0.044	67.33	0.845	-24.79
200	0.598	-80.18	9.191	121.62	0.066	56.98	0.662	-37.77
400	0.442	-118.84	5.505	99.01	0.093	54.34	0.476	-45.43
600	0.392	-140.14	3.887	86.64	0.118	58.30	0.418	-48.57
800	0.374	-154.61	3.029	77.50	0.143	61.09	0.392	-52.48
1000	0.367	-165.56	2.520	70.15	0.169	63.39	0.389	-57.19
1200	0.367	-174.16	2.162	63.07	0.197	64.83	0.391	-61.75
1400	0.373	179.13	1.916	57.27	0.232	65.23	0.398	-67.63
1600	0.378	172.36	1.749	51.58	0.263	62.63	0.412	-74.04
1800	0.384	166.49	1.606	46.28	0.284	62.94	0.424	-79.34
2000	0.391	161.65	1.501	41.77	0.331	63.69	0.445	-83.92

$V_{CE}=5V, I_C=10mA, Z_O=50\Omega$

Freq(MHz)	$ S_{11} $	$\angle S_{11}$	$ S_{21} $	$\angle S_{21}$	$ S_{12} $	$\angle S_{12}$	$ S_{22} $	$\angle S_{22}$
100	0.604	-65.10	17.802	131.98	0.037	62.29	0.725	-33.04
200	0.444	-100.60	11.395	111.07	0.056	60.51	0.514	-43.72
400	0.347	-135.89	6.264	92.91	0.085	63.77	0.367	-46.89
600	0.325	-153.23	4.335	82.90	0.117	66.77	0.332	-49.51
800	0.319	-164.36	3.342	75.17	0.148	67.58	0.321	-54.09
1000	0.321	-173.02	2.760	68.51	0.181	67.37	0.321	-59.12
1200	0.326	-179.73	2.364	62.39	0.211	67.45	0.327	-64.26
1400	0.336	174.71	2.089	57.19	0.249	66.65	0.337	-70.42
1600	0.343	169.12	1.904	51.75	0.280	62.79	0.350	-77.67
1800	0.349	164.16	1.741	46.76	0.300	62.41	0.361	-82.73
2000	0.358	160.18	1.629	42.30	0.347	62.24	0.382	-87.25

55GN01CA

S Parameters (Common emitter)

$V_{CE}=5V, I_C=15mA, Z_O=50\Omega$

Freq(MHz)	$ S_{11} $	$\angle S_{11}$	$ S_{21} $	$\angle S_{21}$	$ S_{12} $	$\angle S_{12}$	$ S_{22} $	$\angle S_{22}$
100	0.511	-75.82	20.333	125.66	0.034	62.58	0.649	-37.05
200	0.379	-111.32	12.202	106.68	0.051	63.43	0.445	-45.58
400	0.315	-144.06	6.538	90.52	0.084	68.22	0.326	-47.13
600	0.302	-158.98	4.489	81.46	0.118	69.82	0.299	-49.32
800	0.301	-168.64	3.455	74.33	0.153	69.70	0.290	-54.83
1000	0.307	-176.32	2.857	67.93	0.186	68.77	0.296	-60.27
1200	0.314	177.94	2.433	62.00	0.217	68.37	0.302	-65.94
1400	0.322	172.88	2.153	57.01	0.256	66.71	0.311	-71.94
1600	0.329	167.84	1.961	51.67	0.286	62.74	0.325	-79.69
1800	0.337	163.07	1.792	46.79	0.308	61.86	0.337	-84.37
2000	0.348	159.32	1.676	42.28	0.355	61.87	0.359	-88.78

$V_{CE}=5V, I_C=20mA, Z_O=50\Omega$

Freq(MHz)	$ S_{11} $	$\angle S_{11}$	$ S_{21} $	$\angle S_{21}$	$ S_{12} $	$\angle S_{12}$	$ S_{22} $	$\angle S_{22}$
100	0.461	-82.96	21.657	121.91	0.031	64.47	0.600	-39.22
200	0.346	-118.63	12.582	104.09	0.049	64.74	0.406	-46.06
400	0.299	-149.09	6.669	89.15	0.084	70.72	0.302	-46.24
600	0.293	-162.67	4.554	80.67	0.118	71.64	0.283	-49.39
800	0.295	-171.32	3.503	73.57	0.153	70.77	0.275	-54.70
1000	0.299	-178.25	2.900	67.59	0.187	69.56	0.282	-60.94
1200	0.307	176.25	2.468	61.65	0.221	68.70	0.290	-66.45
1400	0.316	172.08	2.178	56.76	0.260	66.77	0.300	-72.89
1600	0.325	166.77	1.988	51.53	0.290	62.70	0.316	-80.43
1800	0.333	162.69	1.813	46.81	0.310	62.12	0.325	-85.59
2000	0.343	158.91	1.692	42.30	0.357	61.46	0.347	-89.65

$V_{CE}=5V, I_C=30mA, Z_O=50\Omega$

Freq(MHz)	$ S_{11} $	$\angle S_{11}$	$ S_{21} $	$\angle S_{21}$	$ S_{12} $	$\angle S_{12}$	$ S_{22} $	$\angle S_{22}$
100	0.399	-93.89	22.859	117.43	0.029	65.09	0.537	-40.85
200	0.317	-127.93	12.830	101.25	0.045	68.93	0.364	-45.35
400	0.289	-154.90	6.712	87.64	0.082	71.95	0.281	-44.97
600	0.288	-166.40	4.587	79.56	0.119	72.93	0.266	-48.17
800	0.293	-174.03	3.524	72.71	0.155	72.01	0.262	-54.35
1000	0.298	179.55	2.904	66.80	0.190	70.26	0.269	-60.45
1200	0.306	174.88	2.478	61.04	0.223	69.29	0.279	-66.19
1400	0.318	170.70	2.188	56.20	0.261	66.98	0.289	-73.12
1600	0.327	165.85	1.992	50.94	0.292	63.01	0.305	-80.46
1800	0.336	161.66	1.815	46.08	0.313	62.10	0.318	-85.63
2000	0.347	158.15	1.699	41.95	0.358	61.22	0.337	-90.00

$V_{CE}=5V, I_C=50mA, Z_O=50\Omega$

Freq(MHz)	$ S_{11} $	$\angle S_{11}$	$ S_{21} $	$\angle S_{21}$	$ S_{12} $	$\angle S_{12}$	$ S_{22} $	$\angle S_{22}$
100	0.362	-108.51	22.521	112.91	0.026	65.35	0.481	-39.63
200	0.317	-140.52	12.288	98.38	0.044	72.35	0.338	-40.74
400	0.307	-162.72	6.363	85.74	0.080	73.69	0.278	-40.44
600	0.310	-172.48	4.352	77.92	0.119	74.51	0.271	-44.11
800	0.316	-178.74	3.340	71.23	0.153	72.84	0.270	-50.45
1000	0.324	175.82	2.762	65.12	0.189	71.55	0.280	-57.21
1200	0.333	171.21	2.353	59.35	0.220	70.16	0.289	-63.53
1400	0.345	167.33	2.077	54.36	0.260	68.28	0.300	-70.35
1600	0.354	162.55	1.888	49.16	0.289	63.88	0.317	-78.50
1800	0.363	158.67	1.725	44.33	0.313	63.21	0.330	-83.35
2000	0.376	155.01	1.615	39.70	0.361	62.47	0.352	-88.07

- SANYO Semiconductor Co.,Ltd. assumes no responsibility for equipment failures that result from using products at values that exceed, even momentarily, rated values (such as maximum ratings, operating condition ranges, or other parameters) listed in products specifications of any and all SANYO Semiconductor Co.,Ltd. products described or contained herein.
- SANYO Semiconductor Co.,Ltd. strives to supply high-quality high-reliability products, however, any and all semiconductor products fail or malfunction with some probability. It is possible that these probabilistic failures or malfunction could give rise to accidents or events that could endanger human lives, trouble that could give rise to smoke or fire, or accidents that could cause damage to other property. When designing equipment, adopt safety measures so that these kinds of accidents or events cannot occur. Such measures include but are not limited to protective circuits and error prevention circuits for safe design, redundant design, and structural design.
- In the event that any or all SANYO Semiconductor Co.,Ltd. products described or contained herein are controlled under any of applicable local export control laws and regulations, such products may require the export license from the authorities concerned in accordance with the above law.
- No part of this publication may be reproduced or transmitted in any form or by any means, electronic or mechanical, including photocopying and recording, or any information storage or retrieval system, or otherwise, without the prior written consent of SANYO Semiconductor Co.,Ltd.
- Any and all information described or contained herein are subject to change without notice due to product/technology improvement, etc. When designing equipment, refer to the "Delivery Specification" for the SANYO Semiconductor Co.,Ltd. product that you intend to use.
- Information (including circuit diagrams and circuit parameters) herein is for example only; it is not guaranteed for volume production.
- Upon using the technical information or products described herein, neither warranty nor license shall be granted with regard to intellectual property rights or any other rights of SANYO Semiconductor Co.,Ltd. or any third party. SANYO Semiconductor Co.,Ltd. shall not be liable for any claim or suits with regard to a third party's intellectual property rights which has resulted from the use of the technical information and products mentioned above.

This catalog provides information as of October, 2008. Specifications and information herein are subject to change without notice.