

G3U78XX

3-TERMINAL POSITIVE VOLTAGE REGULATORS

Description

The G3U78XX series of fixed-voltage monolithic integrated-circuit voltage regulators designed for a wide range of applications. These applications include on-card regulation for elimination of noise and distribution problems associated with single-point regulation. Each of these regulators can deliver up to 1 amperes of output current. The internal current limiting and thermal shutdown features of these regulators make them essentially immune to overload.

Features

- 5V, 6V, 8V, 9V, 10V, 12V, 15V, 18V, 24V output voltage available
- Internal Thermal Overload Protection
- High Power Dissipation Capability
- Internal Short-Circuit Current Limiting
- No External Components
- Output Transistor Safe-Area Compensation

Package Dimensions

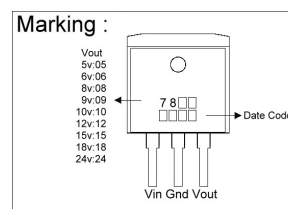
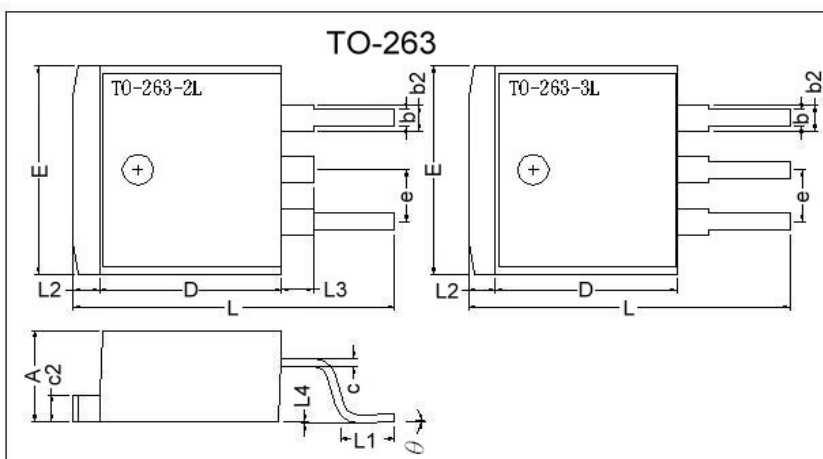

REF.	Millimeter		REF.	Millimeter	
	Min.	Max.		Min.	Max.
A	4.40	4.80	c2	1.25	1.45
b	0.76	1.00	b2	1.17	1.47
L4	0.00	0.30	D	8.6	9.0
c	0.36	0.5	e	2.54 REF.	
L3	1.50 REF.		L	14.6	15.8
L1	2.29	2.79	theta	0°	8°
E	9.80	10.4	L2	1.27 REF.	

Absolute Maximum Ratings

Parameter		Ratings	Unit
Input voltage	G3U7805 ~ 18	35V	V
	G3U7824	40V	V
Output current		1	A
Operating junction temperature range		0 ~ 150	°C
Storage temperature range		-55 ~ 150	°C
Thermal resistance junction-air (RθJA)		65	°C/W
Thermal resistance junction-cases (RθJC)		5	°C/W

Electrical Characteristics

G3U7805 (Refer to the test circuits, $T_j=0\sim 125^\circ\text{C}$, $I_o=500\text{mA}$, $V_{in}=10\text{V}$, $C_{in}=0.33\mu\text{F}$, $C_o=0.1\mu\text{F}$ unless otherwise specified)

Symbol		Min.	Typ.	Max.	Unit	Test Conditions
VO	A-Rank (3%)	4.85	5.0	5.15	V	$V_{in}=10\text{V}$, $I_o=500\text{mA}$, $T_j=25^\circ\text{C}$ $7.5\text{V} \leq V_{in} \leq 20\text{V}$, $5\text{mA} \leq I_o \leq 1\text{A}$, $PD \leq 15\text{W}$
	B-Rank (5%)	4.75	-	5.25		
ΔVO (Line Regulation)		-	3	50	mV	$7\text{V} \leq V_{in} \leq 25\text{V}$, $I_o=500\text{mA}$, $T_j=25^\circ\text{C}$
		-	1	25		$8\text{V} \leq V_{in} \leq 12\text{V}$, $I_o=500\text{mA}$, $T_j=25^\circ\text{C}$
ΔVO (Load Regulation)		-	-	100	mV	$V_{in}=10\text{V}$, $5\text{mA} \leq I_o \leq 1\text{A}$, $T_j=25^\circ\text{C}$
		-	-	50		$V_{in}=10\text{V}$, $250\text{mA} \leq I_o \leq 750\text{mA}$, $T_j=25^\circ\text{C}$
IQ		-	-	8.0	mA	$V_{in}=10\text{V}$, $I_o=500\text{mA}$, $T_j=25^\circ\text{C}$
ΔIQ		-	-	0.5	mA	$V_{in}=10\text{V}$, $5\text{mA} \leq I_o \leq 1\text{A}$
		-	-	1.3		$7\text{V} \leq V_{in} \leq 25\text{V}$, $I_o=500\text{mA}$
Vn		-	40	-	μV	$10\text{Hz} \leq f \leq 100\text{KHz}$, $T_j=25^\circ\text{C}$
RR		-	80	-	dB	$8\text{V} \leq V_{in} \leq 18\text{V}$, $f=120\text{Hz}$, $T_j=25^\circ\text{C}$
VD		-	2	-	V	$I_o=1\text{A}$, $T_j=25^\circ\text{C}$
Isc		-	250	-	mA	$V_{in}=35\text{V}$, $T_j=25^\circ\text{C}$
Ipk		-	1.8	-	A	$T_j=25^\circ\text{C}$
$\Delta Vo / \Delta Tj$		-	-0.6	-	$\text{mV}/^\circ\text{C}$	$I_o=5\text{mA}$, $0^\circ\text{C} \leq T_j \leq 125^\circ\text{C}$

G3U7806 (Refer to the test circuits, $T_j=0\sim 125^\circ\text{C}$, $I_o=500\text{mA}$, $V_{in}=11\text{V}$, $C_{in}=0.33\mu\text{F}$, $C_o=0.1\mu\text{F}$ unless otherwise specified)

Symbol		Min.	Typ.	Max.	Unit	Test Conditions
VO	A-Rank (3%)	5.82	6.0	6.18	V	$V_{in}=11\text{V}$, $I_o=500\text{mA}$, $T_j=25^\circ\text{C}$ $8\text{V} \leq V_{in} \leq 21\text{V}$, $5\text{mA} \leq I_o \leq 1\text{A}$, $PD \leq 15\text{W}$
	B-Rank (5%)	5.70	-	6.30		
ΔVO (Line Regulation)		-	3	60	mV	$8\text{V} \leq V_{in} \leq 25\text{V}$, $I_o=500\text{mA}$, $T_j=25^\circ\text{C}$
		-	1	25		$9\text{V} \leq V_{in} \leq 13\text{V}$, $I_o=500\text{mA}$, $T_j=25^\circ\text{C}$
ΔVO (Load Regulation)		-	-	100	mV	$V_{in}=11\text{V}$, $5\text{mA} \leq I_o \leq 1\text{A}$, $T_j=25^\circ\text{C}$
		-	-	50		$V_{in}=11\text{V}$, $250\text{mA} \leq I_o \leq 750\text{mA}$, $T_j=25^\circ\text{C}$
IQ		-	-	8.0	mA	$V_{in}=11\text{V}$, $I_o=500\text{mA}$, $T_j=25^\circ\text{C}$
ΔIQ		-	-	0.5	mA	$V_{in}=11\text{V}$, $5\text{mA} \leq I_o \leq 1\text{A}$
		-	-	1.3		$8\text{V} \leq V_{in} \leq 25\text{V}$, $I_o=500\text{mA}$
Vn		-	45	-	μV	$10\text{Hz} \leq f \leq 100\text{KHz}$, $T_j=25^\circ\text{C}$
RR		-	75	-	dB	$9\text{V} \leq V_{in} \leq 19\text{V}$, $f=120\text{Hz}$, $T_j=25^\circ\text{C}$
VD		-	2	-	V	$I_o=1\text{A}$, $T_j=25^\circ\text{C}$
Isc		-	250	-	mA	$V_{in}=35\text{V}$, $T_j=25^\circ\text{C}$
Ipk		-	1.8	-	A	$T_j=25^\circ\text{C}$
$\Delta Vo / \Delta Tj$		-	-0.7	-	$\text{mV}/^\circ\text{C}$	$I_o=5\text{mA}$, $0^\circ\text{C} \leq T_j \leq 125^\circ\text{C}$

G3U7808 (Refer to the test circuits, $T_j=0\sim 125^\circ\text{C}$, $I_o=500\text{mA}$, $V_{in}=14\text{V}$, $C_{in}=0.33\mu\text{F}$, $C_o=0.1\mu\text{F}$ unless otherwise specified)

Symbol		Min.	Typ.	Max.	Unit	Test Conditions
VO	A-Rank (3%)	7.76	8.0	8.24	V	$V_{in}=14\text{V}$, $I_o=500\text{mA}$, $T_j=25^\circ\text{C}$ $10.5\text{V} \leq V_{in} \leq 23\text{V}$, $5\text{mA} \leq I_o \leq 1\text{A}$, $PD \leq 15\text{W}$
	B-Rank (5%)	7.60	-	8.40		
ΔVO (Line Regulation)		-	3	80	mV	$10.5\text{V} \leq V_{in} \leq 25\text{V}$, $I_o=500\text{mA}$, $T_j=25^\circ\text{C}$
		-	1	40		$11\text{V} \leq V_{in} \leq 17\text{V}$, $I_o=500\text{mA}$, $T_j=25^\circ\text{C}$
ΔVO (Load Regulation)		-	-	100	mV	$V_{in}=14\text{V}$, $5\text{mA} \leq I_o \leq 1\text{A}$, $T_j=25^\circ\text{C}$
		-	-	50		$V_{in}=14\text{V}$, $250\text{mA} \leq I_o \leq 750\text{mA}$, $T_j=25^\circ\text{C}$
IQ		-	-	8.0	mA	$V_{in}=14\text{V}$, $I_o=500\text{mA}$, $T_j=25^\circ\text{C}$
ΔIQ		-	-	0.5	mA	$V_{in}=14\text{V}$, $5\text{mA} \leq I_o \leq 1\text{A}$
		-	-	1.3		$10.5\text{V} \leq V_{in} \leq 25\text{V}$, $I_o=500\text{mA}$
Vn		-	58	-	μV	$10\text{Hz} \leq f \leq 100\text{KHz}$, $T_j=25^\circ\text{C}$
RR		-	72	-	dB	$11.5\text{V} \leq V_{in} \leq 21.5\text{V}$, $f=120\text{Hz}$, $T_j=25^\circ\text{C}$
VD		-	2	-	V	$I_o=1\text{A}$, $T_j=25^\circ\text{C}$
Isc		-	250	-	mA	$V_{in}=35\text{V}$, $T_j=25^\circ\text{C}$
Ipk		-	1.8	-	A	$T_j=25^\circ\text{C}$
$\Delta\text{Vo} / \Delta\text{Tj}$		-	-0.9	-	$\text{mV}/^\circ\text{C}$	$I_o=5\text{mA}$, $0^\circ\text{C} \leq T_j \leq 125^\circ\text{C}$

G3U7809 (Refer to the test circuits, $T_j=0\sim 125^\circ\text{C}$, $I_o=500\text{mA}$, $V_{in}=15\text{V}$, $C_{in}=0.33\mu\text{F}$, $C_o=0.1\mu\text{F}$ unless otherwise specified)

Symbol		Min.	Typ.	Max.	Unit	Test Conditions
VO	A-Rank (3%)	8.73	9.0	9.27	V	$V_{in}=15\text{V}$, $I_o=500\text{mA}$, $T_j=25^\circ\text{C}$ $11.5\text{V} \leq V_{in} \leq 24\text{V}$, $5\text{mA} \leq I_o \leq 1\text{A}$, $PD \leq 15\text{W}$
	B-Rank (5%)	8.55	-	9.45		
ΔVO (Line Regulation)		-	5	90	mV	$11.5\text{V} \leq V_{in} \leq 25\text{V}$, $I_o=500\text{mA}$, $T_j=25^\circ\text{C}$
		-	3	45		$13\text{V} \leq V_{in} \leq 19\text{V}$, $I_o=500\text{mA}$, $T_j=25^\circ\text{C}$
ΔVO (Load Regulation)		-	-	100	mV	$V_{in}=15\text{V}$, $5\text{mA} \leq I_o \leq 1\text{A}$, $T_j=25^\circ\text{C}$
		-	-	50		$V_{in}=15\text{V}$, $250\text{mA} \leq I_o \leq 750\text{mA}$, $T_j=25^\circ\text{C}$
IQ		-	-	8.0	mA	$V_{in}=15\text{V}$, $I_o=500\text{mA}$, $T_j=25^\circ\text{C}$
ΔIQ		-	-	0.5	mA	$V_{in}=15\text{V}$, $5\text{mA} \leq I_o \leq 1\text{A}$
		-	-	1.3		$11.5\text{V} \leq V_{in} \leq 26\text{V}$, $I_o=500\text{mA}$
Vn		-	58	-	μV	$10\text{Hz} \leq f \leq 100\text{KHz}$, $T_j=25^\circ\text{C}$
RR		-	72	-	dB	$12.5\text{V} \leq V_{in} \leq 22.5\text{V}$, $f=120\text{Hz}$, $T_j=25^\circ\text{C}$
VD		-	2	-	V	$I_o=1\text{A}$, $T_j=25^\circ\text{C}$
Isc		-	250	-	mA	$V_{in}=35\text{V}$, $T_j=25^\circ\text{C}$
Ipk		-	1.8	-	A	$T_j=25^\circ\text{C}$
$\Delta\text{Vo} / \Delta\text{Tj}$		-	-1.1	-	$\text{mV}/^\circ\text{C}$	$I_o=5\text{mA}$, $0^\circ\text{C} \leq T_j \leq 125^\circ\text{C}$

G3U7810 (Refer to the test circuits, $T_j=0\sim 125^\circ\text{C}$, $I_o=500\text{mA}$, $V_{in}=16\text{V}$, $C_{in}=0.33\mu\text{F}$, $C_o=0.1\mu\text{F}$ unless otherwise specified)

Symbol		Min.	Typ.	Max.	Unit	Test Conditions
VO	A-Rank (3%)	9.70	10.0	10.30	V	$V_{in}=16\text{V}$, $I_o=500\text{mA}$, $T_j=25^\circ\text{C}$ $12.5\text{V} \leq V_{in} \leq 25\text{V}$, $5\text{mA} \leq I_o \leq 1\text{A}$, $PD \leq 15\text{W}$
	B-Rank (5%)	9.50	-	10.50		
ΔVO (Line Regulation)		-	-	100	mV	$13\text{V} \leq V_{in} \leq 25\text{V}$, $I_o=500\text{mA}$, $T_j=25^\circ\text{C}$
		-	-	50		$14\text{V} \leq V_{in} \leq 20\text{V}$, $I_o=500\text{mA}$, $T_j=25^\circ\text{C}$
ΔVO (Load Regulation)		-	-	100	mV	$V_{in}=16\text{V}$, $5\text{mA} \leq I_o \leq 1\text{A}$, $T_j=25^\circ\text{C}$
		-	-	50		$V_{in}=16\text{V}$, $250\text{mA} \leq I_o \leq 750\text{mA}$, $T_j=25^\circ\text{C}$
IQ		-	-	8.0	mA	$V_{in}=16\text{V}$, $I_o=500\text{mA}$, $T_j=25^\circ\text{C}$
ΔIQ		-	-	0.5	mA	$V_{in}=16\text{V}$, $5\text{mA} \leq I_o \leq 1\text{A}$
		-	-	1.0		$12.5\text{V} \leq V_{in} \leq 25\text{V}$, $I_o=500\text{mA}$
Vn		-	58	-	μV	$10\text{Hz} \leq f \leq 100\text{KHz}$, $T_j=25^\circ\text{C}$
RR		-	72	-	dB	$13\text{V} \leq V_{in} \leq 23\text{V}$, $f=120\text{Hz}$, $T_j=25^\circ\text{C}$
VD		-	2	-	V	$I_o=1\text{A}$, $T_j=25^\circ\text{C}$
Isc		-	250	-	mA	$V_{in}=35\text{V}$, $T_j=25^\circ\text{C}$
Ipk		-	1.8	-	A	$T_j=25^\circ\text{C}$
$\Delta VO / \Delta T_j$		-	-1.1	-	$\text{mV}/^\circ\text{C}$	$I_o=5\text{mA}$, $0^\circ\text{C} \leq T_j \leq 125^\circ\text{C}$

G3U7812 (Refer to the test circuits, $T_j=0\sim 125^\circ\text{C}$, $I_o=500\text{mA}$, $V_{in}=19\text{V}$, $C_{in}=0.33\mu\text{F}$, $C_o=0.1\mu\text{F}$ unless otherwise specified)

Symbol		Min.	Typ.	Max.	Unit	Test Conditions
VO	A-Rank (3%)	11.64	12.0	12.36	V	$V_{in}=19\text{V}$, $I_o=500\text{mA}$, $T_j=25^\circ\text{C}$ $14.5\text{V} \leq V_{in} \leq 27\text{V}$, $5\text{mA} \leq I_o \leq 1\text{A}$, $PD \leq 15\text{W}$
	B-Rank (5%)	11.40	-	12.60		
ΔVO (Line Regulation)		-	10	120	mV	$14.5\text{V} \leq V_{in} \leq 30\text{V}$, $I_o=500\text{mA}$, $T_j=25^\circ\text{C}$
		-	3	60		$16\text{V} \leq V_{in} \leq 22\text{V}$, $I_o=500\text{mA}$, $T_j=25^\circ\text{C}$
ΔVO (Load Regulation)		-	-	100	mV	$V_{in}=19\text{V}$, $5\text{mA} \leq I_o \leq 1\text{A}$, $T_j=25^\circ\text{C}$
		-	-	60		$V_{in}=19\text{V}$, $250\text{mA} \leq I_o \leq 750\text{mA}$, $T_j=25^\circ\text{C}$
IQ		-	-	8.0	mA	$V_{in}=19\text{V}$, $I_o=500\text{mA}$, $T_j=25^\circ\text{C}$
ΔIQ		-	-	0.5	mA	$V_{in}=19\text{V}$, $5\text{mA} \leq I_o \leq 1\text{A}$
		-	-	1.3		$14.5\text{V} \leq V_{in} \leq 30\text{V}$, $I_o=500\text{mA}$
Vn		-	75	-	μV	$10\text{Hz} \leq f \leq 100\text{KHz}$, $T_j=25^\circ\text{C}$
RR		-	72	-	dB	$15\text{V} \leq V_{in} \leq 25\text{V}$, $f=120\text{Hz}$, $T_j=25^\circ\text{C}$
VD		-	2	-	V	$I_o=1\text{A}$, $T_j=25^\circ\text{C}$
Isc		-	250	-	mA	$V_{in}=35\text{V}$, $T_j=25^\circ\text{C}$
Ipk		-	1.8	-	A	$T_j=25^\circ\text{C}$
$\Delta VO / \Delta T_j$		-	-1.5	-	$\text{mV}/^\circ\text{C}$	$I_o=5\text{mA}$, $0^\circ\text{C} \leq T_j \leq 125^\circ\text{C}$

G3U7815 (Refer to the test circuits, $T_j=0\sim 125^\circ\text{C}$, $I_o=500\text{mA}$, $V_{in}=23\text{V}$, $C_{in}=0.33\mu\text{F}$, $C_o=0.1\mu\text{F}$ unless otherwise specified)

Symbol		Min.	Typ.	Max.	Unit	Test Conditions
VO	A-Rank (3%)	14.55	15.0	15.45	V	$V_{in}=23\text{V}$, $I_o=500\text{mA}$, $T_j=25^\circ\text{C}$ $17.5\text{V} \leq V_{in} \leq 30\text{V}$, $5\text{mA} \leq I_o \leq 1\text{A}$, $PD \leq 15\text{W}$
	B-Rank (5%)	14.25	-	15.75		
ΔVO (Line Regulation)		-	-	150	mV	$17.5\text{V} \leq V_{in} \leq 30\text{V}$, $I_o=500\text{mA}$, $T_j=25^\circ\text{C}$
		-	-	75		$18.5\text{V} \leq V_{in} \leq 30\text{V}$, $I_o=500\text{mA}$, $T_j=25^\circ\text{C}$
ΔVO (Load Regulation)		-	-	150	mV	$V_{in}=23\text{V}$, $5\text{mA} \leq I_o \leq 1\text{A}$, $T_j=25^\circ\text{C}$
		-	-	75		$V_{in}=23\text{V}$, $250\text{mA} \leq I_o \leq 750\text{mA}$, $T_j=25^\circ\text{C}$
IQ		-	-	8.0	mA	$V_{in}=23\text{V}$, $I_o=500\text{mA}$, $T_j=25^\circ\text{C}$
ΔIQ		-	-	0.5	mA	$V_{in}=23\text{V}$, $5\text{mA} \leq I_o \leq 1\text{A}$
		-	-	1.3		$17.5\text{V} \leq V_{in} \leq 30\text{V}$, $I_o=500\text{mA}$
Vn		-	90	-	μV	$10\text{Hz} \leq f \leq 100\text{KHz}$, $T_j=25^\circ\text{C}$
RR		-	70	-	dB	$18.5\text{V} \leq V_{in} \leq 28.5\text{V}$, $f=120\text{Hz}$, $T_j=25^\circ\text{C}$
VD		-	2	-	V	$I_o=1\text{A}$, $T_j=25^\circ\text{C}$
Isc		-	250	-	mA	$V_{in}=35\text{V}$, $T_j=25^\circ\text{C}$
Ipk		-	1.8	-	A	$T_j=25^\circ\text{C}$
$\Delta VO / \Delta T_j$		-	-1.8	-	$\text{mV}/^\circ\text{C}$	$I_o=5\text{mA}$, $0^\circ\text{C} \leq T_j \leq 125^\circ\text{C}$

G3U7818 (Refer to the test circuits, $T_j=0\sim 125^\circ\text{C}$, $I_o=500\text{mA}$, $V_{in}=27\text{V}$, $C_{in}=0.33\mu\text{F}$, $C_o=0.1\mu\text{F}$ unless otherwise specified)

Symbol		Min.	Typ.	Max.	Unit	Test Conditions
VO	A-Rank (3%)	17.46	18.0	18.54	V	$V_{in}=27\text{V}$, $I_o=500\text{mA}$, $T_j=25^\circ\text{C}$ $21\text{V} \leq V_{in} \leq 33\text{V}$, $5\text{mA} \leq I_o \leq 1\text{A}$, $PD \leq 15\text{W}$
	B-Rank (5%)	17.10	-	18.9		
ΔVO (Line Regulation)		-	-	180	mV	$21\text{V} \leq V_{in} \leq 33\text{V}$, $I_o=500\text{mA}$, $T_j=25^\circ\text{C}$
		-	-	90		$24\text{V} \leq V_{in} \leq 30\text{V}$, $I_o=500\text{mA}$, $T_j=25^\circ\text{C}$
ΔVO (Load Regulation)		-	-	180	mV	$V_{in}=27\text{V}$, $5\text{mA} \leq I_o \leq 1\text{A}$, $T_j=25^\circ\text{C}$
		-	-	90		$V_{in}=27\text{V}$, $250\text{mA} \leq I_o \leq 750\text{mA}$, $T_j=25^\circ\text{C}$
IQ		-	-	8.0	mA	$V_{in}=27\text{V}$, $I_o=500\text{mA}$, $T_j=25^\circ\text{C}$
ΔIQ		-	-	0.5	mA	$V_{in}=27\text{V}$, $5\text{mA} \leq I_o \leq 1\text{A}$
		-	-	1.0		$21\text{V} \leq V_{in} \leq 33\text{V}$, $I_o=500\text{mA}$
Vn		-	110	-	μV	$10\text{Hz} \leq f \leq 100\text{KHz}$, $T_j=25^\circ\text{C}$
RR		-	69	-	dB	$22\text{V} \leq V_{in} \leq 32\text{V}$, $f=120\text{Hz}$, $T_j=25^\circ\text{C}$
VD		-	2	-	V	$I_o=1\text{A}$, $T_j=25^\circ\text{C}$
Isc		-	250	-	mA	$V_{in}=35\text{V}$, $T_j=25^\circ\text{C}$
Ipk		-	1.8	-	A	$T_j=25^\circ\text{C}$
$\Delta VO / \Delta T_j$		-	-2.2	-	$\text{mV}/^\circ\text{C}$	$I_o=5\text{mA}$, $0^\circ\text{C} \leq T_j \leq 125^\circ\text{C}$

G3U7824 (Refer to the test circuits, $T_j=0\sim 125^\circ\text{C}$, $I_o=500\text{mA}$, $V_{in}=33\text{V}$, $C_{in}=0.33\mu\text{F}$, $C_o=0.1\mu\text{F}$ unless otherwise specified)

Symbol		Min.	Typ.	Max.	Unit	Test Conditions
VO	A-Rank (3%)	23.28	24.0	24.72	V	$V_{in}=33\text{V}$, $I_o=500\text{mA}$, $T_j=25^\circ\text{C}$ $27\text{V} \leq V_{in} \leq 38\text{V}$, $5\text{mA} \leq I_o \leq 1\text{A}$, $PD \leq 15\text{W}$
	B-Rank (5%)	22.80	-	25.20		
ΔVO (Line Regulation)		-	-	240	mV	$27\text{V} \leq V_{in} \leq 38\text{V}$, $I_o=500\text{mA}$, $T_j=25^\circ\text{C}$
		-	-	120		$30\text{V} \leq V_{in} \leq 36\text{V}$, $I_o=500\text{mA}$, $T_j=25^\circ\text{C}$
ΔVO (Load Regulation)		-	-	240	mV	$V_{in}=33\text{V}$, $5\text{mA} \leq I_o \leq 1\text{A}$, $T_j=25^\circ\text{C}$
		-	-	120		$V_{in}=33\text{V}$, $250\text{mA} \leq I_o \leq 750\text{mA}$, $T_j=25^\circ\text{C}$
IQ		-	-	8.0	mA	$V_{in}=33\text{V}$, $I_o=500\text{mA}$, $T_j=25^\circ\text{C}$
ΔIQ		-	-	0.5	mA	$V_{in}=33\text{V}$, $5\text{mA} \leq I_o \leq 1\text{A}$
		-	-	1.0		$28\text{V} \leq V_{in} \leq 38\text{V}$, $I_o=500\text{mA}$
Vn		-	170	-	μV	$10\text{Hz} \leq f \leq 100\text{KHz}$, $T_j=25^\circ\text{C}$
RR		-	66	-	dB	$28\text{V} \leq V_{in} \leq 38\text{V}$, $f=120\text{Hz}$, $T_j=25^\circ\text{C}$
VD		-	2	-	V	$I_o=1\text{A}$, $T_j=25^\circ\text{C}$
Isc		-	250	-	mA	$V_{in}=35\text{V}$, $T_j=25^\circ\text{C}$
Ipk		-	1.8	-	A	$T_j=25^\circ\text{C}$
$\Delta V_o / \Delta T_j$		-	-2.8	-	$\text{mV}/^\circ\text{C}$	$I_o=5\text{mA}$, $0^\circ\text{C} \leq T_j \leq 125^\circ\text{C}$

Typical Application

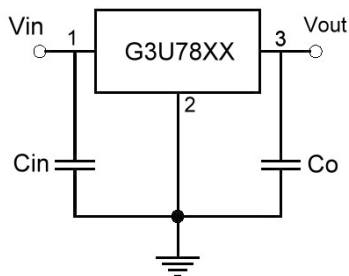

Characteristics Curve

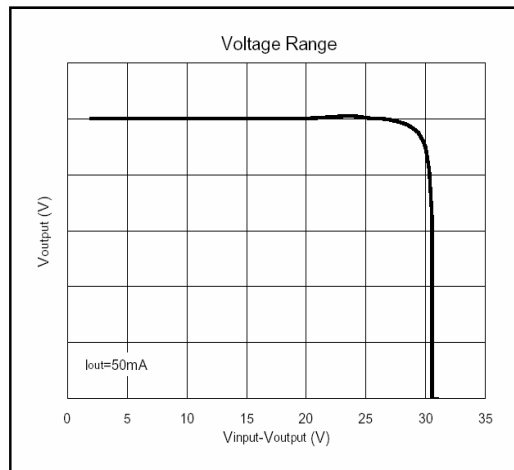
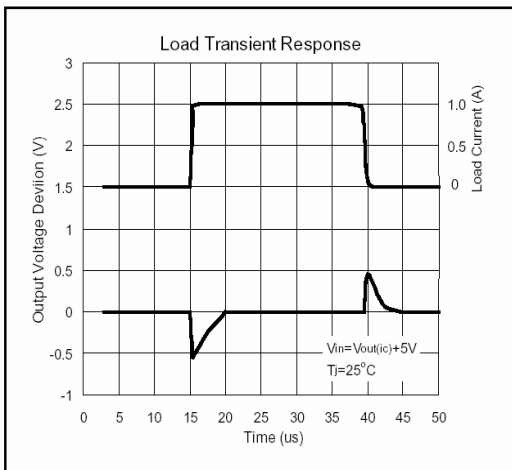
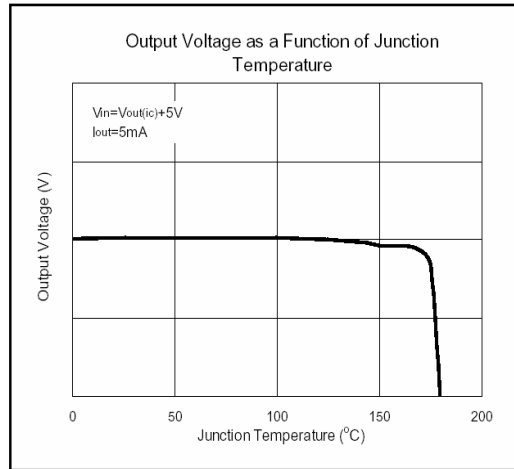
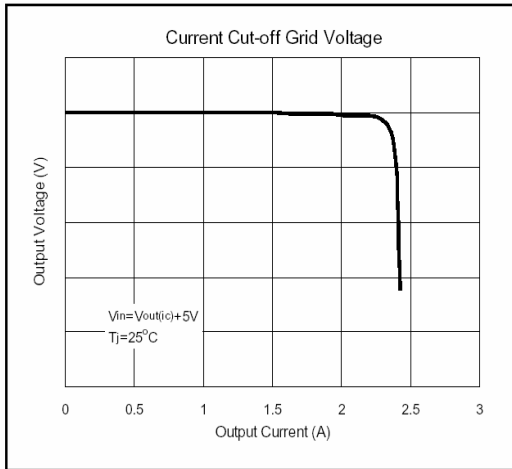

Important Notice:

- All rights are reserved. Reproduction in whole or in part is prohibited without the prior written approval of GTM.
- GTM reserves the right to make changes to its products without notice.
- GTM semiconductor products are not warranted to be suitable for use in life-support Applications, or systems.
- GTM assumes no liability for any consequence of customer product design, infringement of patents, or application assistance.

Head Office And Factory:

- **Taiwan:** No. 17-1 Tatung Rd. Fu Kou Hsin-Chu Industrial Park, Hsin-Chu, Taiwan, R. O. C.
- TEL : 886-3-597-7061 FAX : 886-3-597-9220, 597-0785
- **China:** (201203) No.255, Jang-Jiang Tsai-Lueng RD. , Pu-Dung-Hsin District, Shang-Hai City, China
- TEL : 86-21-5895-7671 ~ 4 FAX : 86-21-38950165