



TS7800B series

3-Terminal Fixed Positive Voltage Regulator

TO-220



ITO-220



Pin assignment:
 1. Input
 2. Ground
 3. Output
 (Heatsink surface connected to Pin 2)

Voltage Range 5V to 24V
Output Current up to 1.5A

General Description

These voltage regulators are monolithic integrated circuits designed as fixed-voltage regulators for a wide variety of applications including local, on-card regulation. These regulators employ internal current limiting, thermal shutdown, and safe-area compensation. With adequate heatsink they can deliver output currents up to 1.5 ampere.

Although designed primarily as a fixed voltage regulator, these devices can be used with external components to obtain adjustable voltages and currents.

This series is offered in 3-pin TO-220, ITO-220 package.

Features

- ◇ Output current up to 1.5A
- ◇ No external components required
- ◇ Internal thermal overload protection
- ◇ Internal short-circuit current limiting
- ◇ Output transistor safe-area compensation
- ◇ Output voltage offered in 4% tolerance

Standard Application

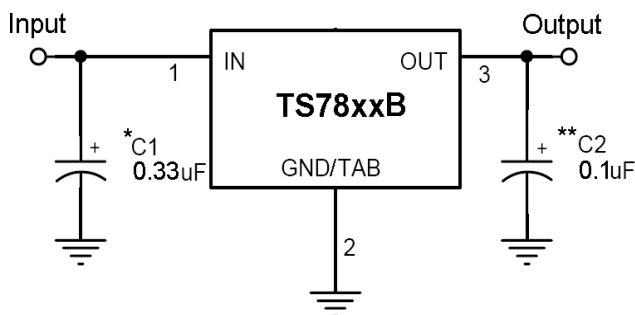

A common ground is required between the input and the output voltages. The input voltage must remain typically 2.0V above the output voltage even during the low point on the Input ripple voltage.

XX = these two digits of the type number indicate voltage.

* = Cin is required if regulator is located an appreciable distance from power supply filter.

** = Co is not needed for stability; however, it does improve transient response.

Ordering Information

Part No.	Operating Temp.	Package
TS78xxBCZ	0 ~ +125°C	TO-220
TS78xxBCI		ITO-220

Note: Where xx denotes voltage option.

Absolute Maximum Rating

Input Voltage	V _{in} *	35	V
Input Voltage	V _{in} **	40	V
Power Dissipation	TO-220	Without heatsink	2
	TO-220	P _t ***	15
	ITO-220	Without heatsink	10
Operating Junction Temperature Range	T _J	0 ~ +125	°C
Storage Temperature Range	T _{STG}	-65 ~ +150	°C

Note : * TS7805B to TS781B

** TS7824B

*** Follow the derating curve



TS7805B Electrical Characteristics

($V_{in}=10V$, $I_{out}=500mA$, $0^{\circ}C \leq T_j \leq 125^{\circ}C$, $C_{in}=0.33\mu F$, $C_{out}=0.1\mu F$; unless otherwise specified.)

Parameter	Symbol	Test Conditions	Min	Typ	Max	Unit	
Output voltage	V_{out}	$T_j=25^{\circ}C$	4.80	5	5.20	V	
		$7.5V \leq V_{in} \leq 20V$, $10mA \leq I_{out} \leq 1.5A$, $PD \leq 15W$	4.75	5	5.25		
Line Regulation	REGline	$T_j=25^{\circ}C$	$7.5V \leq V_{in} \leq 25V$	--	3	100	mV
			$8V \leq V_{in} \leq 12V$	--	1	50	
Load Regulation	REGload	$T_j=25^{\circ}C$	$10mA \leq I_{out} \leq 1.5A$	--	15	100	mV
			$250mA \leq I_{out} \leq 750mA$	--	5	50	
Quiescent Current	I_q	$I_{out}=0$, $T_j=25^{\circ}C$	--	4.2	8	mA	
Quiescent Current Change	ΔI_q	$7.5V \leq V_{in} \leq 25V$	--	--	1.3		
		$10mA \leq I_{out} \leq 1.5A$	--	--	0.5		
Output Noise Voltage	V_n	$10Hz \leq f \leq 100KHz$, $T_j=25^{\circ}C$	--	40	--	μV	
Ripple Rejection Ratio	RR	$f=120Hz$, $8V \leq V_{in} \leq 18V$	62	78	--	dB	
Voltage Drop	V_{drop}	$I_{out}=1.0A$, $T_j=25^{\circ}C$	--	2	--	V	
Output Resistance	R_{out}	$f=1KHz$	--	17	--	$m\Omega$	
Output Short Circuit Current	I_{os}	$T_j=25^{\circ}C$	--	750	--	mA	
Peak Output Current	$I_{o peak}$	$T_j=25^{\circ}C$	--	2.2	--	A	
Temperature Coefficient of Output Voltage	$\Delta V_{out} / \Delta T_j$	$I_{out}=10mA$, $0^{\circ}C \leq T_j \leq 125^{\circ}C$	--	-0.6	--	$mV / ^{\circ}C$	

TS7806B Electrical Characteristics

($V_{in}=11V$, $I_{out}=500mA$, $0^{\circ}C \leq T_j \leq 125^{\circ}C$, $C_{in}=0.33\mu F$, $C_{out}=0.1\mu F$; unless otherwise specified.)

Parameter	Symbol	Test Conditions	Min	Typ	Max	Unit	
Output Voltage	V_{out}	$T_j=25^{\circ}C$	5.76	6	6.24	V	
		$8.5V \leq V_{in} \leq 21V$, $10mA \leq I_{out} \leq 1.5A$, $PD \leq 15W$	6.70	6	6.30		
Line Regulation	REGline	$T_j=25^{\circ}C$	$8.5V \leq V_{in} \leq 25V$	--	5	120	mV
			$9V \leq V_{in} \leq 13V$	--	1.5	60	
Load Regulation	REGload	$T_j=25^{\circ}C$	$10mA \leq I_{out} \leq 1.5A$	--	14	120	mV
			$250mA \leq I_{out} \leq 750mA$	--	4	60	
Quiescent Current	I_q	$I_{out}=0$, $T_j=25^{\circ}C$	--	4.3	8	mA	
Quiescent Current Change	ΔI_q	$8.5V \leq V_{in} \leq 25V$	--	--	1.3		
		$10mA \leq I_{out} \leq 1.5A$	--	--	0.5		
Output Noise Voltage	V_n	$10Hz \leq f \leq 100KHz$, $T_j=25^{\circ}C$	--	45	--	μV	
Ripple Rejection Ratio	RR	$f=120Hz$, $9V \leq V_{in} \leq 19V$	59	75	--	dB	
Voltage Drop	V_{drop}	$I_{out}=1.0A$, $T_j=25^{\circ}C$	--	2	--	V	
Output Resistance	R_{out}	$f=1KHz$	--	19	--	$m\Omega$	
Output Short Circuit Current	I_{os}	$T_j=25^{\circ}C$	--	550	--	mA	
Peak Output Current	$I_{o peak}$	$T_j=25^{\circ}C$	--	2.2	--	A	
Temperature Coefficient of Output Voltage	$\Delta V_{out} / \Delta T_j$	$I_{out}=10mA$, $0^{\circ}C \leq T_j \leq 125^{\circ}C$	--	-0.7	--	$mV / ^{\circ}C$	

- Pulse testing techniques are used to maintain the junction temperature as close to the ambient temperature as possible, and thermal effects must be taken into account separately.
- This specification applies only for DC power dissipation permitted by absolute maximum ratings.



TS7808B Electrical Characteristics

($V_{in}=14V$, $I_{out}=500mA$, $0^{\circ}C \leq T_j \leq 125^{\circ}C$, $C_{in}=0.33\mu F$, $C_{out}=0.1\mu F$; unless otherwise specified.)

Parameter	Symbol	Test Conditions	Min	Typ	Max	Unit	
Output Voltage	V_{out}	$T_j=25^{\circ}C$	7.68	8	8.32	V	
		$10.5V \leq V_{in} \leq 23V$, $10mA \leq I_{out} \leq 1.5A$, $PD \leq 15W$	7.60	8	8.40		
Line Regulation	REG _{line}	$T_j=25^{\circ}C$	$10.5V \leq V_{in} \leq 25V$	--	6	160	mV
			$11V \leq V_{in} \leq 17V$	--	2	80	
Load Regulation	REG _{load}	$T_j=25^{\circ}C$	$10mA \leq I_{out} \leq 1.5A$	--	12	160	mV
			$250mA \leq I_{out} \leq 750mA$	--	4	80	
Quiescent Current	I_q	$I_{out}=0$, $T_j=25^{\circ}C$	--	4.3	8	mA	
Quiescent Current Change	ΔI_q	$10.5V \leq V_{in} \leq 25V$	--	--	1		
		$10mA \leq I_{out} \leq 1.5A$	--	--	0.5		
Output Noise Voltage	V_n	$10Hz \leq f \leq 100KHz$, $T_j=25^{\circ}C$	--	52	--	μV	
Ripple Rejection Ratio	RR	$f=120Hz$, $11V \leq V_{in} \leq 21V$	56	72	--	dB	
Voltage Drop	V_{drop}	$I_{out}=1.0A$, $T_j=25^{\circ}C$	--	2	--	V	
Output Resistance	R_{out}	$f=1KHz$	--	16	--	$m\Omega$	
Output Short Circuit Current	I_{os}	$T_j=25^{\circ}C$	--	450	--	mA	
Peak Output Current	$I_{o peak}$	$T_j=25^{\circ}C$	--	2.2	--	A	
Temperature Coefficient of Output Voltage	$\Delta V_{out} / \Delta T_j$	$I_{out}=10mA$, $0^{\circ}C \leq T_j \leq 125^{\circ}C$	--	-0.8	--	$mV/^{\circ}C$	

TS7809B Electrical Characteristics

($V_{in}=15V$, $I_{out}=500mA$, $0^{\circ}C \leq T_j \leq 125^{\circ}C$, $C_{in}=0.33\mu F$, $C_{out}=0.1\mu F$; unless otherwise specified.)

Parameter	Symbol	Test Conditions	Min	Typ	Max	Unit	
Output Voltage	V_{out}	$T_j=25^{\circ}C$	8.64	9	9.36	V	
		$11.5V \leq V_{in} \leq 23V$, $10mA \leq I_{out} \leq 1.5A$, $PD \leq 15W$	8.55	9	9.45		
Line Regulation	REG _{line}	$T_j=25^{\circ}C$	$11.5V \leq V_{in} \leq 26V$	--	6	180	mV
			$12V \leq V_{in} \leq 17V$	--	2	90	
Load Regulation	REG _{load}	$T_j=25^{\circ}C$	$10mA \leq I_{out} \leq 1.5A$	--	12	180	mV
			$250mA \leq I_{out} \leq 750mA$	--	4	90	
Quiescent Current	I_q	$I_{out}=0$, $T_j=25^{\circ}C$	--	4.3	8	mA	
Quiescent Current Change	ΔI_q	$11.5V \leq V_{in} \leq 26V$	--	--	1		
		$10mA \leq I_{out} \leq 1.5A$	--	--	0.5		
Output Noise Voltage	V_n	$10Hz \leq f \leq 100KHz$, $T_j=25^{\circ}C$	--	52	--	μV	
Ripple Rejection Ratio	RR	$f=120Hz$, $12V \leq V_{in} \leq 22V$	55	72	--	dB	
Voltage Drop	V_{drop}	$I_{out}=1.0A$, $T_j=25^{\circ}C$	--	2	--	V	
Output Resistance	R_{out}	$f=1KHz$	--	16	--	$m\Omega$	
Output Short Circuit Current	I_{os}	$T_j=25^{\circ}C$	--	450	--	mA	
Peak Output Current	$I_{o peak}$	$T_j=25^{\circ}C$	--	2.2	--	A	
Temperature Coefficient of Output Voltage	$\Delta V_{out} / \Delta T_j$	$I_{out}=10mA$, $0^{\circ}C \leq T_j \leq 125^{\circ}C$	--	-1	--	$mV/^{\circ}C$	

- Pulse testing techniques are used to maintain the junction temperature as close to the ambient temperature as possible, and thermal effects must be taken into account separately.
- This specification applies only for DC power dissipation permitted by absolute maximum ratings.



TS7810B Electrical Characteristics

($V_{in}=16V$, $I_{out}=500mA$, $0^{\circ}C \leq T_j \leq 125^{\circ}C$, $C_{in}=0.33\mu F$, $C_{out}=0.1\mu F$; unless otherwise specified.)

Parameter	Symbol	Test Conditions	Min	Typ	Max	Unit	
Output Voltage	V_{out}	$T_j=25^{\circ}C$	9.6	10	10.4	V	
		$12.5V \leq V_{in} \leq 25V$, $10mA \leq I_{out} \leq 1.5A$, $PD \leq 15W$	9.5	10	10.5		
Line Regulation	REG _{line}	$T_j=25^{\circ}C$	$12.5V \leq V_{in} \leq 28V$	--	7	200	mV
			$13V \leq V_{in} \leq 17V$	--	2	100	
Load Regulation	REG _{load}	$T_j=25^{\circ}C$	$10mA \leq I_{out} \leq 1.5A$	--	12	200	mV
			$250mA \leq I_{out} \leq 750mA$	--	4	100	
Quiescent Current	I_q	$I_{out}=0$, $T_j=25^{\circ}C$	--	4.3	8	mA	
Quiescent Current Change	ΔI_q	$12.5V \leq V_{in} \leq 28V$	--	--	1		
		$10mA \leq I_{out} \leq 1.5A$	--	--	0.5		
Output Noise Voltage	V_n	$10Hz \leq f \leq 100KHz$, $T_j=25^{\circ}C$	--	70	--	μV	
Ripple Rejection Ratio	RR	$f=120Hz$, $13V \leq V_{in} \leq 23V$	55	71	--	dB	
Voltage Drop	V_{drop}	$I_{out}=1.0A$, $T_j=25^{\circ}C$	--	2	--	V	
Output Resistance	R_{out}	$f=1KHz$	--	18	--	$m\Omega$	
Output Short Circuit Current	I_{os}	$T_j=25^{\circ}C$	--	400	--	mA	
Peak Output Current	$I_{o peak}$	$T_j=25^{\circ}C$	--	2.2	--	A	
Temperature Coefficient of Output Voltage	$\Delta V_{out} / \Delta T_j$	$I_{out}=10mA$, $0^{\circ}C \leq T_j \leq 125^{\circ}C$	--	-1	--	$mV / ^{\circ}C$	

TS7812B Electrical Characteristics

($V_{in}=19V$, $I_{out}=500mA$, $0^{\circ}C \leq T_j \leq 125^{\circ}C$, $C_{in}=0.33\mu F$, $C_{out}=0.1\mu F$; unless otherwise specified.)

Parameter	Symbol	Test Conditions	Min	Typ	Max	Unit	
Output Voltage	V_{out}	$T_j=25^{\circ}C$	11.52	12	12.48	V	
		$14.5V \leq V_{in} \leq 27V$, $10mA \leq I_{out} \leq 1.5A$, $PD \leq 15W$	11.40	12	12.60		
Line Regulation	REG _{line}	$T_j=25^{\circ}C$	$14.5V \leq V_{in} \leq 30V$	--	10	240	mV
			$15V \leq V_{in} \leq 19V$	--	3	120	
Load Regulation	REG _{load}	$T_j=25^{\circ}C$	$10mA \leq I_{out} \leq 1.5A$	--	12	240	mV
			$250mA \leq I_{out} \leq 750mA$	--	4	120	
Quiescent Current	I_q	$T_j=25^{\circ}C$, $I_{out}=0$	--	4.3	8	mA	
Quiescent Current Change	ΔI_q	$14.5V \leq V_{in} \leq 30V$	--	--	1		
		$10mA \leq I_{out} \leq 1.5A$	--	--	0.5		
Output Noise Voltage	V_n	$10Hz \leq f \leq 100KHz$, $T_j=25^{\circ}C$	--	75	--	μV	
Ripple Rejection Ratio	RR	$f=120Hz$, $15V \leq V_{in} \leq 25V$	55	71	--	dB	
Voltage Drop	V_{drop}	$I_{out}=1.0A$, $T_j=25^{\circ}C$	--	2	--	V	
Output Resistance	R_{out}	$f=1KHz$	--	18	--	$m\Omega$	
Output Short Circuit Current	I_{os}	$T_j=25^{\circ}C$	--	350	--	mA	
Peak Output Current	$I_{o peak}$	$T_j=25^{\circ}C$	--	2.2	--	A	
Temperature Coefficient of Output Voltage	$\Delta V_{out} / \Delta T_j$	$I_{out}=10mA$, $0^{\circ}C \leq T_j \leq 125^{\circ}C$	--	-1	--	$mV / ^{\circ}C$	

- Pulse testing techniques are used to maintain the junction temperature as close to the ambient temperature as possible, and thermal effects must be taken into account separately.
- This specification applies only for DC power dissipation permitted by absolute maximum ratings.



TS7815B Electrical Characteristics

($V_{in}=23V$, $I_{out}=500mA$, $0^{\circ}C \leq T_j \leq 125^{\circ}C$, $C_{in}=0.33\mu F$, $C_{out}=0.1\mu F$; unless otherwise specified.)

Parameter	Symbol	Test Conditions	Min	Typ	Max	Unit	
Output Voltage	V_{out}	$T_j=25^{\circ}C$	14.40	15	15.60	V	
		$17.5V \leq V_{in} \leq 30V$, $10mA \leq I_{out} \leq 1.5A$, $PD \leq 15W$	14.25	15	15.75		
Line Regulation	REG _{line}	$T_j=25^{\circ}C$	$17.5V \leq V_{in} \leq 30V$	--	12	300	mV
			$18V \leq V_{in} \leq 22V$	--	3	150	
Load Regulation	REG _{load}	$T_j=25^{\circ}C$	$10mA \leq I_{out} \leq 1.5A$	--	12	300	mV
			$250mA \leq I_{out} \leq 750mA$	--	4	150	
Quiescent Current	I_q	$T_j=25^{\circ}C$, $I_{out}=0$	--	4.3	8	mA	
Quiescent Current Change	ΔI_q	$17.5V \leq V_{in} \leq 30V$	--	--	1		
		$10mA \leq I_{out} \leq 1.5A$	--	--	0.5		
Output Noise Voltage	V_n	$10Hz \leq f \leq 100KHz$, $T_j=25^{\circ}C$	--	90	--	μV	
Ripple Rejection Ratio	RR	$f=120Hz$, $18V \leq V_{in} \leq 28V$	54	70	--	dB	
Voltage Drop	V_{drop}	$I_{out}=1.0A$, $T_j=25^{\circ}C$	--	2	--	V	
Output Resistance	R_{out}	$f=1KHz$	--	19	--	$m\Omega$	
Output Short Circuit Current	I_{os}	$T_j=25^{\circ}C$	--	230	--	mA	
Peak Output Current	$I_{o peak}$	$T_j=25^{\circ}C$	--	2.2	--	A	
Temperature Coefficient of Output Voltage	$\Delta V_{out} / \Delta T_j$	$I_{out}=10mA$, $0^{\circ}C \leq T_j \leq 125^{\circ}C$	--	-1	--	$mV / ^{\circ}C$	

TS7818B Electrical Characteristics

($V_{in}=27V$, $I_{out}=500mA$, $0^{\circ}C \leq T_j \leq 125^{\circ}C$, $C_{in}=0.33\mu F$, $C_{out}=0.1\mu F$; unless otherwise specified.)

Parameter	Symbol	Test Conditions	Min	Typ	Max	Unit	
Output Voltage	V_{out}	$T_j=25^{\circ}C$	17.28	18	18.72	V	
		$21V \leq V_{in} \leq 33V$, $10mA \leq I_{out} \leq 1.5A$, $PD \leq 15W$	17.10	18	18.90		
Line Regulation	REG _{line}	$T_j=25^{\circ}C$	$21V \leq V_{in} \leq 33V$	--	15	360	mV
			$22V \leq V_{in} \leq 26V$	--	5	180	
Load Regulation	REG _{load}	$T_j=25^{\circ}C$	$10mA \leq I_{out} \leq 1.5A$	--	12	360	mV
			$250mA \leq I_{out} \leq 750mA$	--	4	180	
Quiescent Current	I_q	$T_j=25^{\circ}C$, $I_{out}=0$	--	4.5	8	mA	
Quiescent Current Change	ΔI_q	$21V \leq V_{in} \leq 33V$	--	--	1		
		$10mA \leq I_{out} \leq 1.5A$	--	--	0.5		
Output Noise Voltage	V_n	$10Hz \leq f \leq 100KHz$, $T_j=25^{\circ}C$	--	110	--	μV	
Ripple Rejection Ratio	RR	$f=120Hz$, $21V \leq V_{in} \leq 31V$	54	70	--	dB	
Voltage Drop	V_{drop}	$I_{out}=1.0A$, $T_j=25^{\circ}C$	--	2	--	V	
Output Resistance	R_{out}	$f=1KHz$	--	22	--	$m\Omega$	
Output Short Circuit Current	I_{os}	$T_j=25^{\circ}C$	--	200	--	mA	
Peak Output Current	$I_{o peak}$	$T_j=25^{\circ}C$	--	2.2	--	A	
Temperature Coefficient of Output Voltage	$\Delta V_{out} / \Delta T_j$	$I_{out}=10mA$, $0^{\circ}C \leq T_j \leq 125^{\circ}C$	--	-1	--	$mV / ^{\circ}C$	

- Pulse testing techniques are used to maintain the junction temperature as close to the ambient temperature as possible, and thermal effects must be taken into account separately.
- This specification applies only for DC power dissipation permitted by absolute maximum ratings.



TS7824B Electrical Characteristics

($V_{in}=33V$, $I_{out}=500mA$, $0^{\circ}C \leq T_j \leq 125^{\circ}C$, $C_{in}=0.33\mu F$, $C_{out}=0.1\mu F$; unless otherwise specified.)

Parameter	Symbol	Test Conditions	Min	Typ	Max	Unit	
Output Voltage	V_{out}	$T_j=25^{\circ}C$	23.04	24	24.96	V	
		$27V \leq V_{in} \leq 38V$, $10mA \leq I_{out} \leq 1.5A$, $PD \leq 15W$	22.80	24	25.20		
Line Regulation	REG _{line}	$T_j=25^{\circ}C$	$27V \leq V_{in} \leq 38V$	--	18	480	mV
			$28V \leq V_{in} \leq 32V$	--	6	240	
Load Regulation	REG _{load}	$T_j=25^{\circ}C$	$10mA \leq I_{out} \leq 1.5A$	--	12	480	mV
			$250mA \leq I_{out} \leq 750mA$	--	4	240	
Quiescent Current	I_q	$I_{out}=0$, $T_j=25^{\circ}C$	--	4.6	8	mA	
Quiescent Current Change	ΔI_q	$27V \leq V_{in} \leq 38V$	--	--	1		
		$10mA \leq I_{out} \leq 1.5A$	--	--	0.5		
Output Noise Voltage	V_n	$10Hz \leq f \leq 100KHz$, $T_j=25^{\circ}C$	--	170	--	μV	
Ripple Rejection Ratio	RR	$f=120Hz$, $27V \leq V_{in} \leq 37V$	54	70	--	dB	
Voltage Drop	V_{drop}	$I_{out}=1.0A$, $T_j=25^{\circ}C$	--	2	--	V	
Output Resistance	R_{out}	$f=1KHz$	--	28	--	$m\Omega$	
Output Short Circuit Current	I_{os}	$T_j=25^{\circ}C$	--	150	--	mA	
Peak Output Current	$I_{o peak}$	$T_j=25^{\circ}C$	--	2.2	--	A	
Temperature Coefficient of Output Voltage	$\Delta V_{out} / \Delta T_j$	$I_{out}=10mA$, $0^{\circ}C \leq T_j \leq 125^{\circ}C$	--	-1.5	--	$mV / ^{\circ}C$	

- Pulse testing techniques are used to maintain the junction temperature as close to the ambient temperature as possible, and thermal effects must be taken into account separately.
- This specification applies only for DC power dissipation permitted by absolute maximum ratings.

Electrical Characteristics Curve

FIGURE 1 - Worst Case Power Dissipation v.s. Ambient Temperature

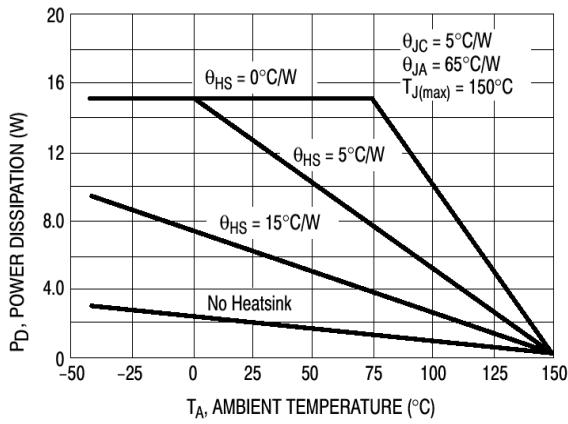

FIGURE 2 - Peak Output Current v.s. Input-Output Differential Voltage

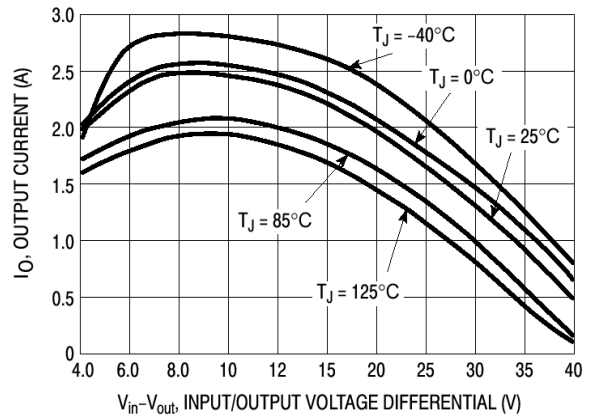

FIGURE 3 - Quiescent Current v.s. Junction Temperature

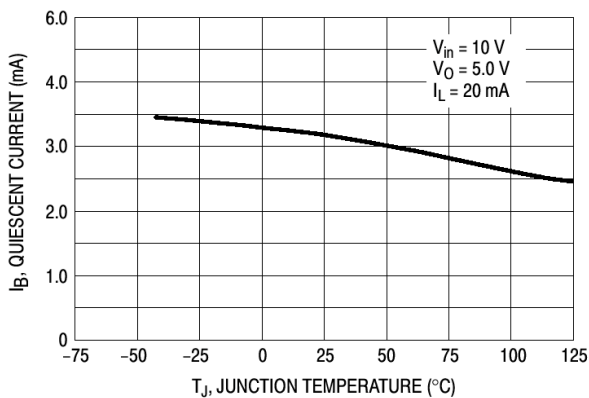

FIGURE 4 - Input Output Differential v.s. Junction Temperature

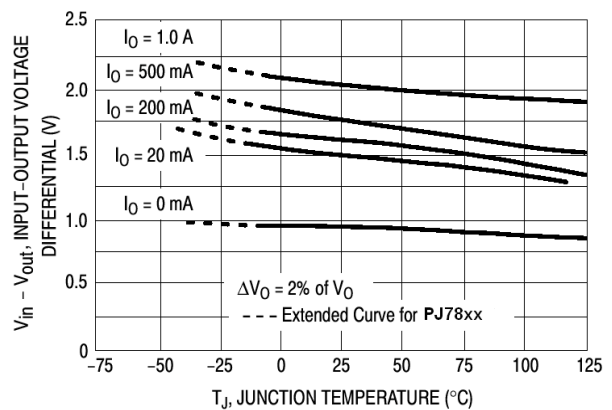

FIGURE 5 - Output Voltage v.s. Junction Temperature

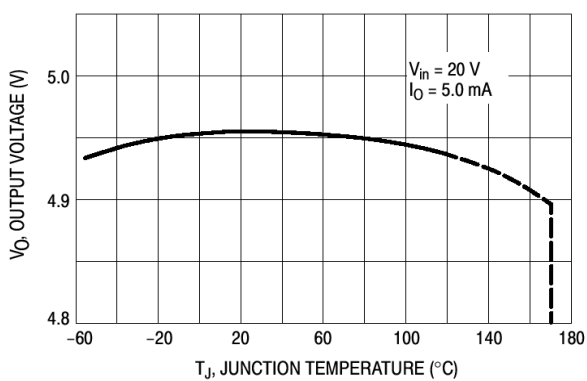
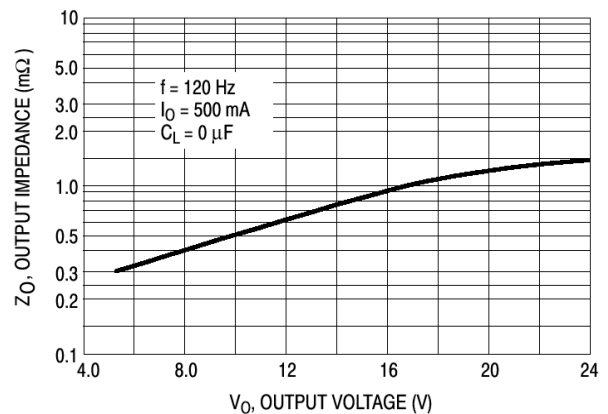
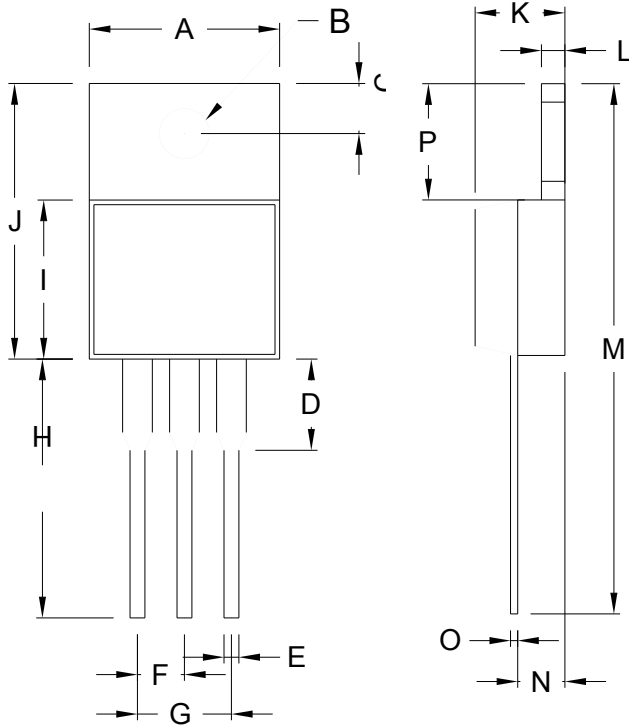

FIGURE 6 - Output Impedance v.s. Output Voltage



TO-220 Mechanical Drawing



TO-220 DIMENSION				
DIM	MILLIMETERS		INCHES	
	MIN	MAX	MIN	MAX
A	10.000	10.500	0.394	0.413
B	3.240	4.440	0.128	0.175
C	2.440	2.940	0.096	0.116
D	-	6.350	-	0.250
E	0.381	1.106	0.015	0.040
F	2.345	2.715	0.092	0.058
G	4.690	5.430	0.092	0.107
H	12.700	14.732	0.500	0.581
I	8.382	9.017	0.330	0.355
J	14.224	16.510	0.560	0.650
K	3.556	4.826	0.140	0.190
L	0.508	1.397	0.020	0.055
M	27.700	29.620	1.060	1.230
N	2.032	2.921	0.080	0.115
O	0.255	0.610	0.010	0.024
P	5.842	6.858	0.230	0.270

ITO-220 Mechanical Drawing

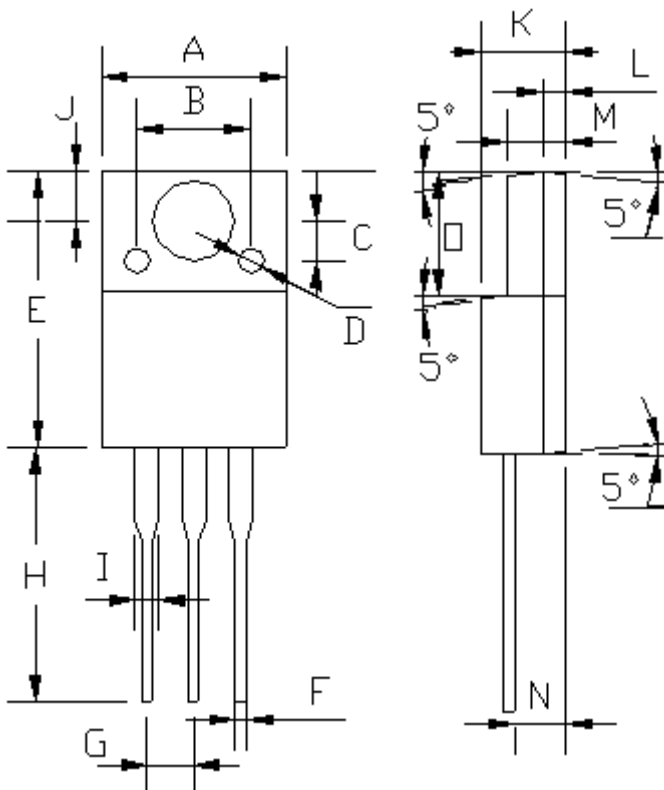

ITO-220 DIMENSION				
DIM	MILLIMETERS		INCHES	
	MIN	MAX	MIN	MAX
A	10.04	10.07	0.395	0.396
B	6.20 (typ.)		0.244 (typ.)	
C	2.20 (typ.)		0.087 (typ.)	
D	§ 1.40 (typ.)		§ 0.055 (typ.)	
E	15.0	15.20	0.591	0.598
F	0.52	0.54	0.020	0.021
G	2.35	2.73	0.093	0.107
H	13.50	13.55	0.531	0.533
I	1.11	1.49	0.044	0.058
J	2.60	2.80	0.102	0.110
K	4.49	4.50	0.176	0.177
L	1.15 (typ.)		0.045 (typ.)	
M	3.03	3.05	0.119	0.120
N	2.60	2.80	0.102	0.110
O	6.55	6.65	0.258	0.262