

## 6 AMP ULTRAFAST RECOVERY DIODES

### FEATURES

- Low switching noise
- Low forward voltage drop
- Low thermal resistance
- High switching capability
- High surge capability
- High reliability

**RoHS COMPLIANT**

### MECHANICAL DATA

- Case: Molded epoxy (U/L Flammability Rating 94V-0)
- Terminals: Plated axial leads
- Solderability: Per MIL-STD 202 Method 208 guaranteed
- Polarity: Color band denotes cathode
- Mounting Position: Any
- Weight: 0.07 Ounces (2.1 Grams)

### MECHANICAL SPECIFICATION

ACTUAL SIZE OF  
UFR600 PACKAGE



SERIES UFR600 - UFR608

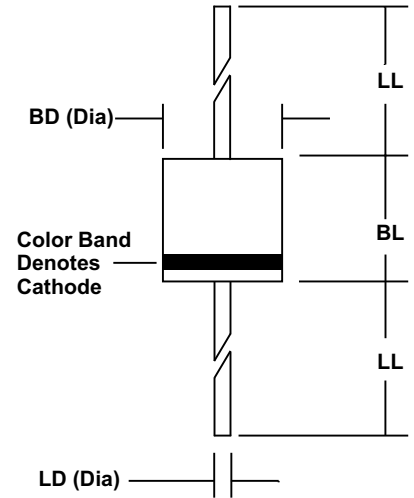

Sym	Minimum		Maximum	
	In	mm	In	mm
BL	0.340	8.6	0.360	9.1
BD	0.340	8.6	0.360	9.1
LL	1.00	25.4		
LD	0.048	1.2	0.052	1.3

### MAXIMUM RATINGS & ELECTRICAL CHARACTERISTICS

Ratings at 25 °C ambient temperature unless otherwise specified.  
 Single phase, half wave, 60Hz, resistive or inductive load.  
 For capacitive loads, derate current by 20%.

PARAMETER (TEST CONDITIONS)	SYMBOL	RATINGS								UNITS
		UFR 600	UFR 601	UFR 602	UFR 603	UFR 604	UFR 606	UFR 608		
Series Number										
Maximum DC Blocking Voltage	V <sub>RM</sub>	50	100	200	300	400	600	800		VOLTS
Maximum RMS Voltage	V <sub>RMS</sub>	35	70	140	210	280	420	560		
Maximum Peak Recurrent Reverse Voltage	V <sub>R</sub> RM	50	100	200	300	400	600	800		
Average Forward Rectified Current @ T <sub>A</sub> = 55 °C	I <sub>O</sub>	6								AMPS
Peak Forward Surge Current ( 8.3mS single half sine wave superimposed on rated load)	I <sub>FSM</sub>	300								
Maximum Forward Voltage at 6 Amps DC	V <sub>FM</sub>	1.25						1.4		VOLTS
Maximum Average DC Reverse Current @ T <sub>C</sub> = 25 °C At Rated DC Blocking Voltage @ T <sub>C</sub> = 100 °C	I <sub>RM</sub>	10 200								μA
Typical Thermal Resistance, Junction to Case	R <sub>θJC</sub>	10								°C/W
Typical Junction Capacitance (Note 1)	C <sub>J</sub>	100								pF
Maximum Reverse Recovery Time (I <sub>F</sub> =0.5A, I <sub>R</sub> =1A, I <sub>RR</sub> =0.25A)	T <sub>RR</sub>	60			75			90		nSec
Junction Operating and Storage Temperature Range	T <sub>J</sub> , T <sub>STG</sub>	-65 to +150								°C

NOTES: (1) Measured at 1 MHz and an applied reverse voltage of 4 volts.

01.00 / sss08

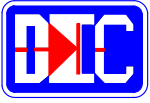

## 6 AMP ULTRAFAST RECOVERY DIODES

### RATING & CHARACTERISTIC CURVES FOR SERIES UFR600 - UFR608

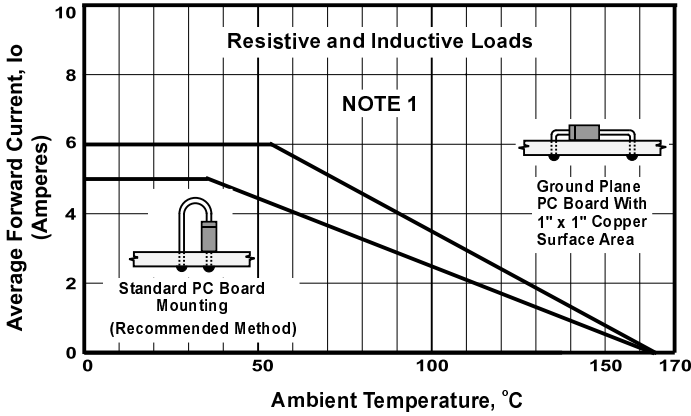

FIGURE 1. FORWARD CURRENT DERATING CURVE

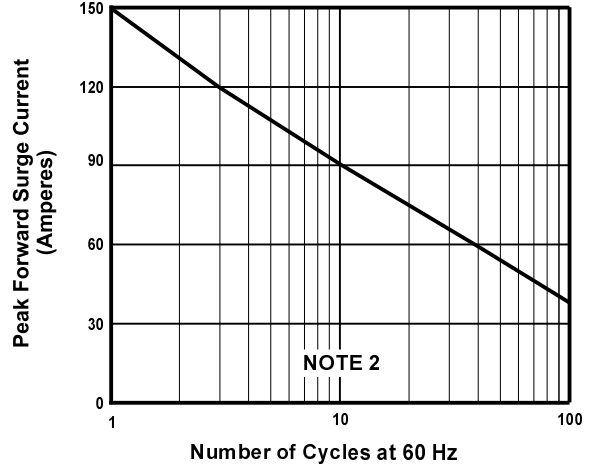

FIGURE 2. MAXIMUM NON-REPETITIVE SURGE CURRENT

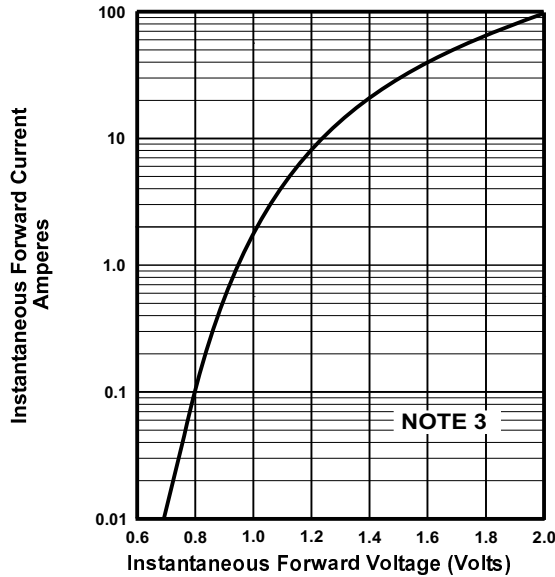

FIGURE 3. TYPICAL FORWARD CHARACTERISTICS

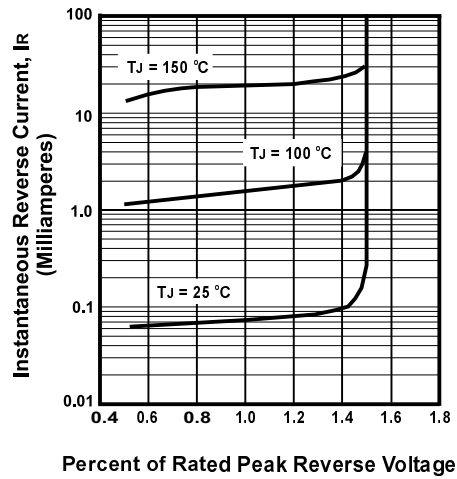

FIGURE 4. TYPICAL REVERSE CHARACTERISTICS

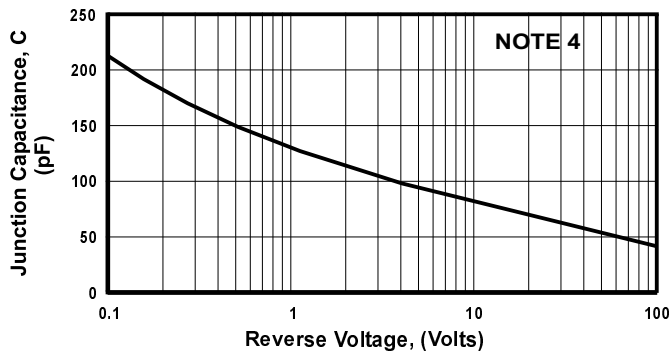

FIGURE 5. TYPICAL JUNCTION CAPACITANCE

#### NOTES

- (1) Single Phase, Half Wave, 60 Hz
- (2) JEDEC Method, 8.3 mSec. Single Half Sine Wave;
- (3)  $T_J = 25^\circ\text{C}$ , Pulse Width = 300  $\mu\text{Sec}$ , 2.0% Duty Cycle
- (4)  $T_J = 25^\circ\text{C}$ ,  $f = 1\text{ MHz}$ ,  $V_{\text{SIG}} = 50\text{ mV P-P}$