

### Features

- 17 dB Gain at 900 MHz
- 17 dBm P1dB at 900 MHz
- 30 dBm Output IP3 at 900 MHz
- 3.7 dB NF at 900 MHz
- MTTF > 100 Years
- Single Supply

### Description

The ASW103, a power amplifier MMIC, has a high linearity, high gain, and high efficiency over a wide range of frequency, being suitable for use in both receiver and transmitter of telecommunication systems up to 4 GHz. The amplifier is available in an SOT-89 package and passes through the stringent DC, RF, and reliability tests.



Package Style: SOT-89

### Typical Performance

Parameters	Units	Typical	
Frequency	MHz	900	2000
Gain	dB	17	11
S11	dB	-9	-9
S22	dB	-15	-15
Output IP3 <sup>1)</sup>	dBm	30	31
Noise Figure	dB	3.7	3.9
Output P1dB	dBm	17	18
Current	mA	44	44
Device Voltage	V	3.3	3.3

1) OIP3 is measured with two tones at an output power of +0 dBm/tone separated by 1 MHz.

### Product Specifications

Parameters	Units	Min	Typ	Max
Testing Frequency	MHz		900	
Gain	dB	16	17	
S11	dB		-9	
S22	dB		-15	
Output IP3	dBm	29	30	
Noise Figure	dB		3.7	4.0
Output P1dB	dBm	16	17	
Current	mA	39	44	49
Device Voltage	V		3.3	

### Absolute Maximum Ratings

Parameters	Rating
Operating Case Temperature	-40 to +85°C
Storage Temperature	-40 to +150°C
Device Voltage	+4 V
Operating Junction Temperature	+150°C
Input RF Power (CW, 50ohm matched)*	25 dBm

\* Please find the max. input power data from [http://www.asb.co.kr/pdf/Maximum\\_Input\\_Power\\_Analysis.pdf](http://www.asb.co.kr/pdf/Maximum_Input_Power_Analysis.pdf)

### Application Circuit

- IF
- IF (3.4 V)
- 500 ~ 2500 MHz

### Pin Configuration

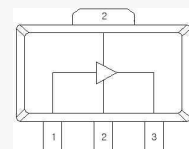

Pin No.	Function
1	RF IN
2	GND
3	RF OUT / Bias

### Outline Drawing

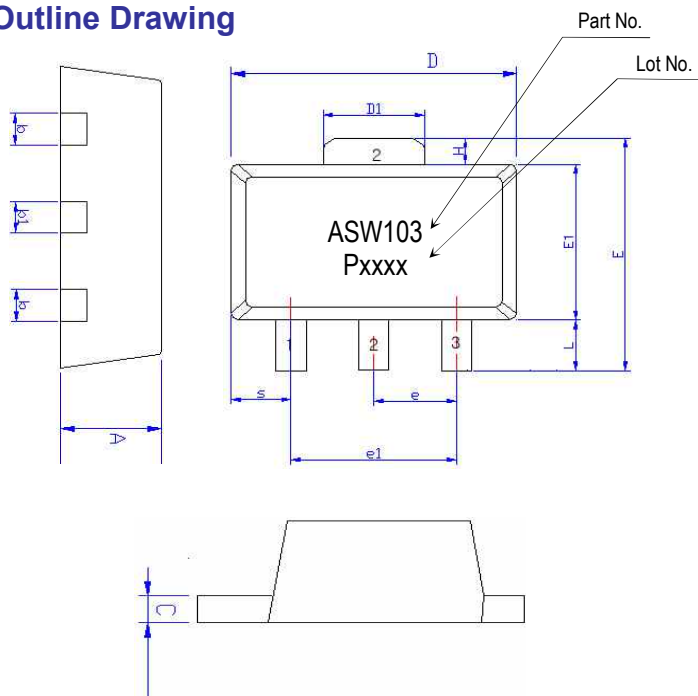

Symbols	Dimensions (In mm)		
	MIN	NOM	MAX
A	1.40	1.50	1.60
L	0.89	1.04	1.20
b	0.36	0.42	0.48
b1	0.41	0.47	0.53
C	0.38	0.40	0.43
D	4.40	4.50	4.60
D1	1.40	1.60	1.75
E	3.64	---	4.25
E1	2.40	2.50	2.60
e1	2.90	3.00	3.10
H	0.35	0.40	0.45
S	0.65	0.75	0.85
e	1.40	1.50	1.60

Pin No.	Function
1	RF IN
2	GND
3	RF OUT / Bias

### Mounting Recommendation (in mm)

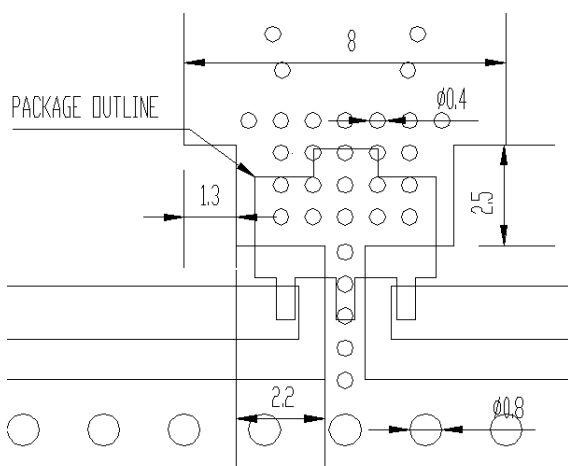

- Note:**
1. The number and size of ground via holes in a circuit board is critical for thermal and RF grounding considerations.
  2. We recommend that the ground via holes be placed on the bottom of the lead pin 2 and exposed pad of the device for better RF and thermal performance, as shown in the drawing at the left side.

### Ordering Information

Part Number	Description
-------------	-------------

**APPLICATION CIRCUIT**

---

**IF**

---

**5 ~ 450 MHz**

---

**+3.3 V**

Frequency (MHz)	5	150	300	450
Magnitude S21 (dB)	25	24	23	21
Magnitude S11 (dB)	-15	-14	-12	-11
Magnitude S22 (dB)	-13	-15	-14	-14
Output P1dB (dBm)	17	17	17	17
Output IP3 <sup>1)</sup> (dBm)	29	30	30.5	30
Noise Figure (dB)	3.5	3.8	4.0	3.7
Device Voltage (V)	3.3			
Current (mA)	44			

1) OIP3 is measured with two tones at an output power of +0 dBm/tone separated by 1 MHz.

### Schematic

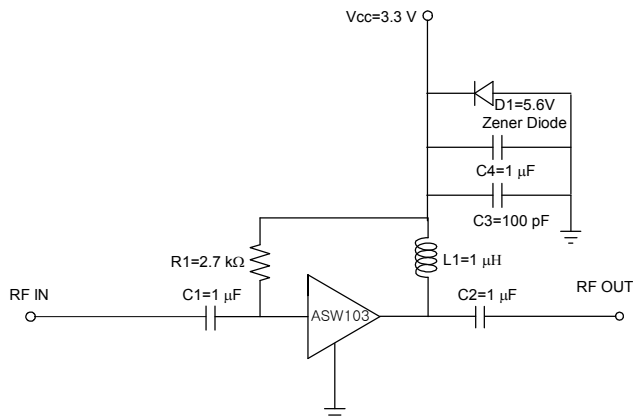

### Board Layout (FR4, 40x40 mm<sup>2</sup>, 0.8T)

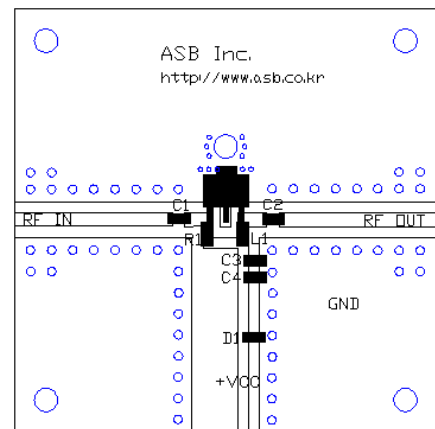

### S-parameters & K-factor

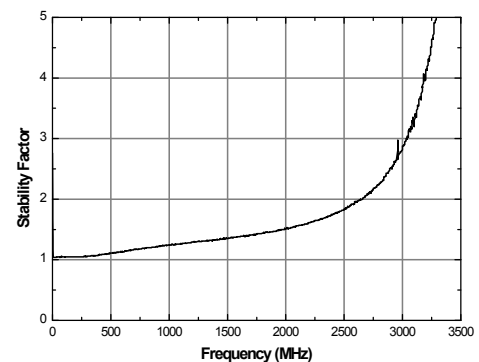
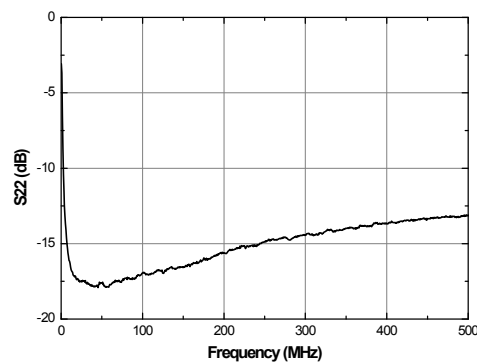
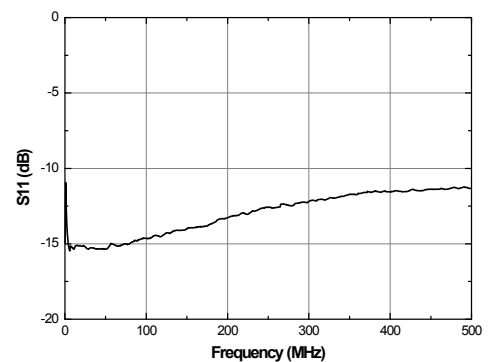
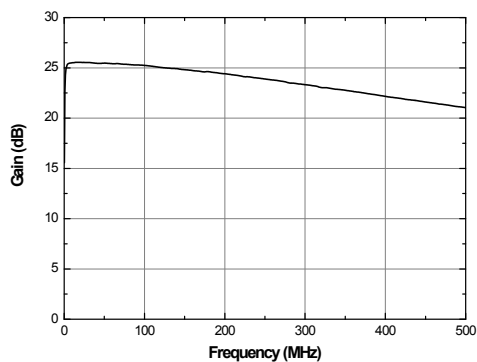

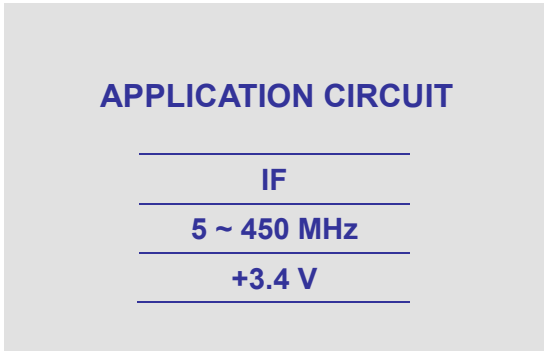

Frequency (MHz)	70	150
Magnitude S21 (dB)	25	24
Magnitude S11 (dB)	-14	-14
Magnitude S22 (dB)	-15	-15
Output P1dB (dBm)	17.5	18
Output IP3 <sup>1)</sup> (dBm)	30	31.5
Noise Figure (dB)	4.1	4.3
Device Voltage (V)	3.4	
Current (mA)	50	

1) OIP3 is measured with two tones at an output power of +0 dBm/tone separated by 1 MHz.

### Schematic

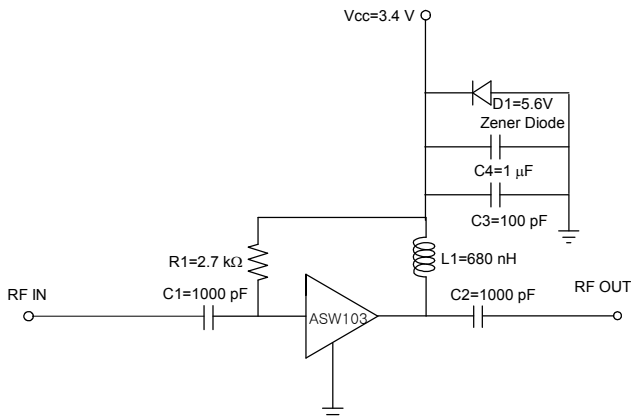

### Board Layout (FR4, 40x40 mm<sup>2</sup>, 0.8T)

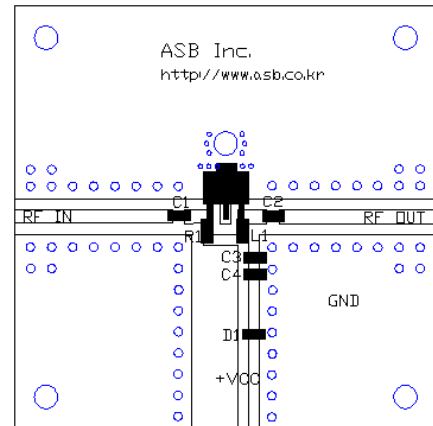

### S-parameters & K-factor

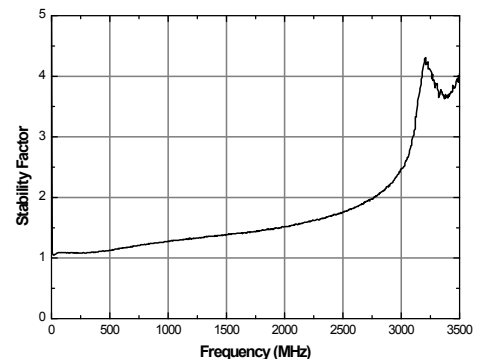
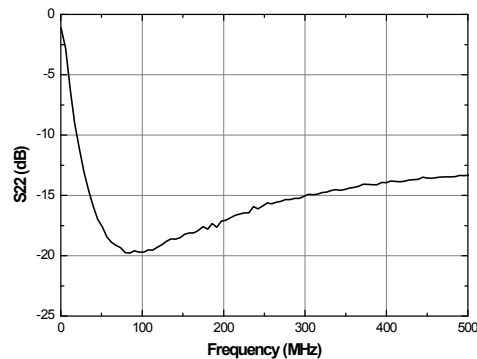
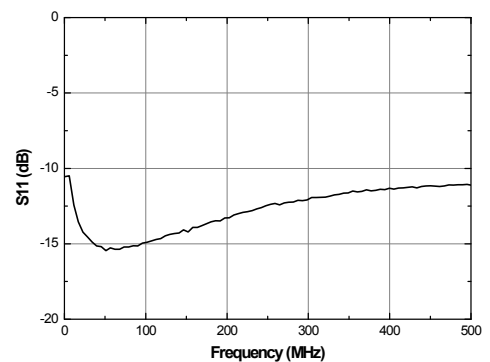
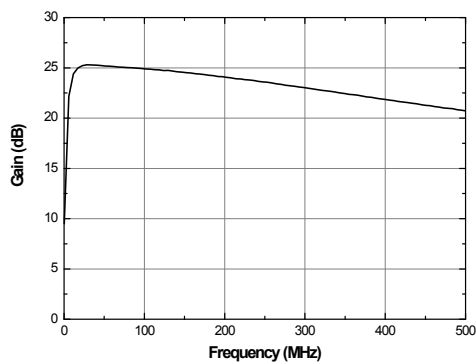

### APPLICATION CIRCUIT

500 ~ 2500 MHz

+3.3 V

Frequency (MHz)	500	900	1750	2000	2400
Magnitude S21 (dB)	21	17	12	11	9
Magnitude S11 (dB)	-8.5	-9	-9	-9	-7.5
Magnitude S22 (dB)	-18	-15	-15	-15	-13.5
Output P1dB (dBm)	17	17	18	18	19
Output IP3 <sup>1)</sup> (dBm)	30	30	31	31	31
Noise Figure (dB)	4.0	3.7	3.7	3.9	4.2
Device Voltage (V)	3.3				
Current (mA)	44				

1) OIP3 is measured with two tones at an output power of +0 dBm/tone separated by 1 MHz.

### Schematic

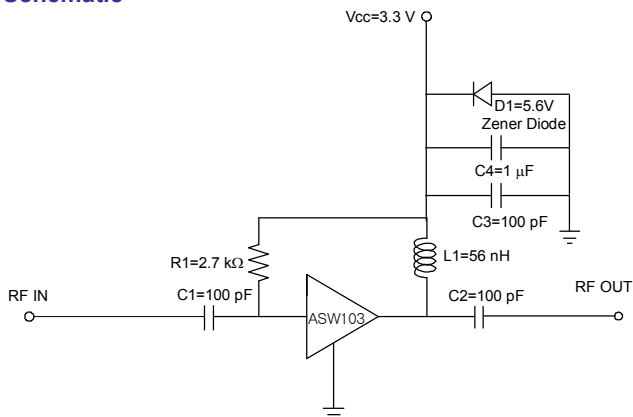

### Board Layout (FR4, 40x40 mm<sup>2</sup>, 0.8T)

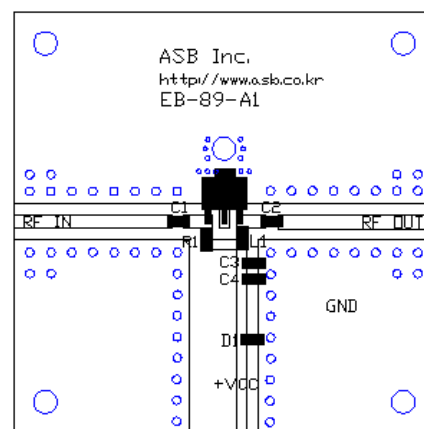

### S-parameters & K-factor

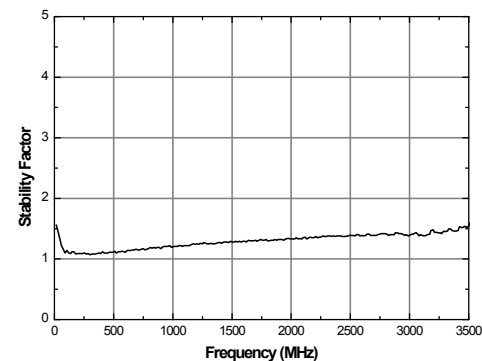
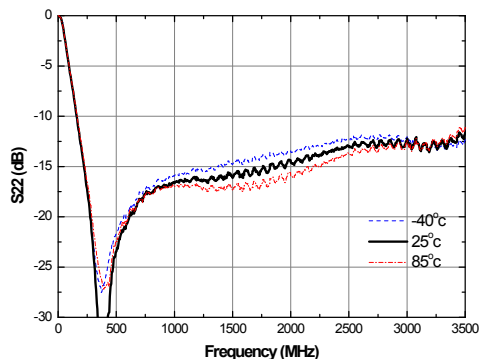
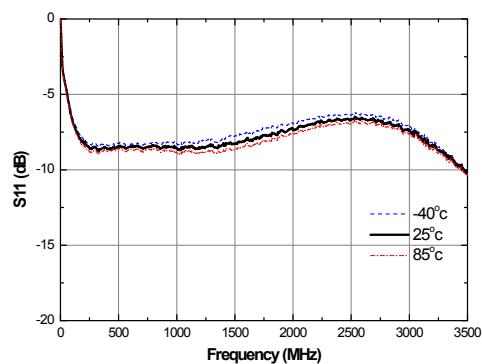
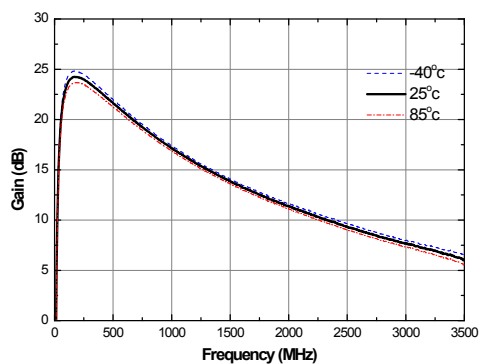

### Current vs. Temperature

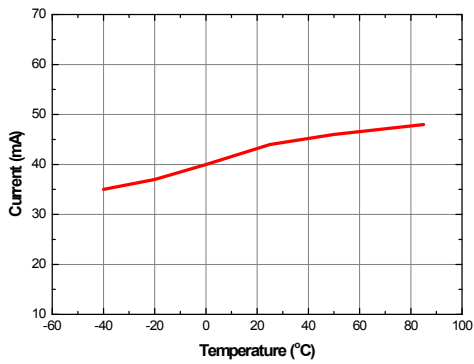

### Gain vs. Temperature

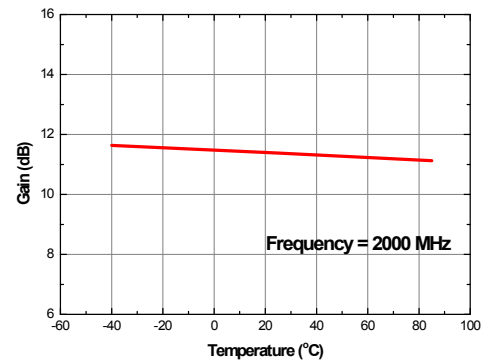

### P1dB vs. Temperature

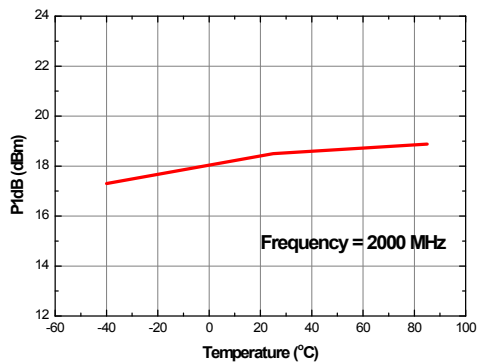

### Output IP3 vs. Temperature

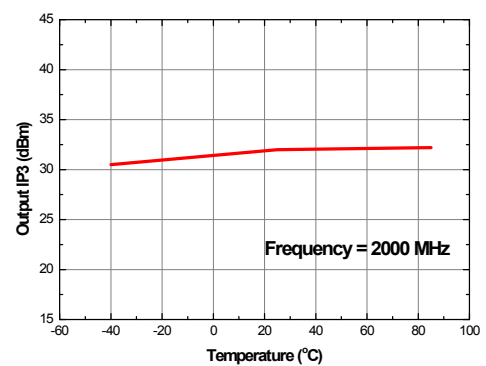

### Output IP3 vs. Tone Power (Frequency = 2000 MHz)

