



LCD Driver for 60 Display Units BL55024

1 General Description

The BL55024 is a general LCD driver IC for 60 units LCD panel. It features a wide operating supply voltage range, incorporates simple communication interface with microcomputer and is suitable for multiple application.

2 Features

- Advanced low power CMOS Technology
- Selection of 1/2 or 1/3 bias, selection of 1/2 or 1/3 or 1/4 duty.
- Operation voltage: 2.5~5.5V
- Serial data interface
- 60(15x4) Display Units
- Low power dissipation design: Power saving mode: Idd=14uA at 5V and Idd=9uA at 3.3V;
- On-chip RC oscillator
- VLCD for adjusting LCD operating voltage
- Excellent EMC immunity
- Compatible with general microcomputer
- SOP24 package

3 Pin Assignment

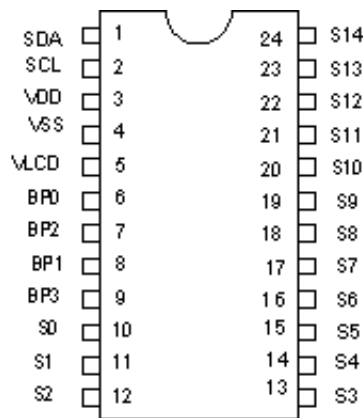

Fig 1

4 Pin Description

Pin No.	Pin name	Function
1	SDA	Serial data input/output
2	SCI	Serial clock input
3	Vdd	Supply voltage
4	Vss	ground
5	Vlcd	LCD supply voltage
6-9	Com0、Com2、Com1、Com3	Common terminal driving output
10-24	S0—S14	Segment terminal driving output

Tab.1



5 Function Description

1. function circuit

The BL550024 has all function circuits that can directly drive any static or multiplexed LCD containing up to four commons and up to 15 segments. The function circuits include: Power-on reset, LCD bias generator, LCD voltage selector, Oscillator, display RAM, Timing, Display latch, Shift register, Common/segment outputs, input/output bank selector, Blinker, Data pointer, etc.

2. display function description

The display RAM is a static 15x 4-bit RAM which stores LCD data. A logic 1 in the RAM bit-map indicates the on state of the corresponding LCD segment; similarly, a logic 0 indicates the off state. There is a one-to-one correspondence between the RAM addresses and the segment outputs, and between the individual bits of a RAM word and the common outputs. (see Fig.2).

Display RAM address and SEGMENT (S0-S14) output														
COM (Com0- Com3) 输出		0	1	2	3	11	12	13	14	
	0													
	1													
	2													
	3													

Fig2

When display data is transmitted to the BL55024, the display bytes received are stored in the display RAM in accordance with the selected LCD drive mode. To illustrate the filling order, an example of a 7-segment numeric display showing all drive modes is given in Fig.3; the RAM filling organization depicted applies equally to other LCD types.

drive mode	LCD segments	LCD backplanes	display RAM filling order	transmitted display byte																																																															
static			<table border="1"> <tr> <td></td> <td>n</td> <td>n+1</td> <td>n+2</td> <td>n+3</td> <td>n+4</td> <td>n+5</td> <td>n+6</td> <td>n+7</td> </tr> <tr> <td>bit/</td> <td>c</td> <td>b</td> <td>a</td> <td>f</td> <td>g</td> <td>e</td> <td>d</td> <td>DP</td> </tr> <tr> <td>BP</td> <td>1</td> <td>x</td> <td>x</td> <td>x</td> <td>x</td> <td>x</td> <td>x</td> <td>x</td> </tr> <tr> <td></td> <td>2</td> <td>x</td> <td>x</td> <td>x</td> <td>x</td> <td>x</td> <td>x</td> <td>x</td> </tr> <tr> <td></td> <td>3</td> <td>x</td> <td>x</td> <td>x</td> <td>x</td> <td>x</td> <td>x</td> <td>x</td> </tr> </table>		n	n+1	n+2	n+3	n+4	n+5	n+6	n+7	bit/	c	b	a	f	g	e	d	DP	BP	1	x	x	x	x	x	x	x		2	x	x	x	x	x	x	x		3	x	x	x	x	x	x	x	<table border="1"> <tr> <td colspan="7">MSB</td> <td colspan="2">LSB</td> </tr> <tr> <td>c</td> <td>b</td> <td>a</td> <td>f</td> <td>g</td> <td>e</td> <td>d</td> <td>DP</td> <td></td> </tr> </table>	MSB							LSB		c	b	a	f	g	e	d	DP	
	n	n+1	n+2	n+3	n+4	n+5	n+6	n+7																																																											
bit/	c	b	a	f	g	e	d	DP																																																											
BP	1	x	x	x	x	x	x	x																																																											
	2	x	x	x	x	x	x	x																																																											
	3	x	x	x	x	x	x	x																																																											
MSB							LSB																																																												
c	b	a	f	g	e	d	DP																																																												
1 : 2 multiplex			<table border="1"> <tr> <td></td> <td>n</td> <td>n+1</td> <td>n+2</td> <td>n+3</td> </tr> <tr> <td>bit/</td> <td>a</td> <td>f</td> <td>e</td> <td>d</td> </tr> <tr> <td>BP</td> <td>1</td> <td>b</td> <td>g</td> <td>c</td> </tr> <tr> <td></td> <td>2</td> <td>x</td> <td>x</td> <td>x</td> </tr> <tr> <td></td> <td>3</td> <td>x</td> <td>x</td> <td>x</td> </tr> </table>		n	n+1	n+2	n+3	bit/	a	f	e	d	BP	1	b	g	c		2	x	x	x		3	x	x	x	<table border="1"> <tr> <td colspan="4">MSB</td> <td colspan="4">LSB</td> </tr> <tr> <td>a</td> <td>b</td> <td>f</td> <td>g</td> <td>e</td> <td>c</td> <td>d</td> <td>DP</td> </tr> </table>	MSB				LSB				a	b	f	g	e	c	d	DP																						
	n	n+1	n+2	n+3																																																															
bit/	a	f	e	d																																																															
BP	1	b	g	c																																																															
	2	x	x	x																																																															
	3	x	x	x																																																															
MSB				LSB																																																															
a	b	f	g	e	c	d	DP																																																												
1 : 3 multiplex			<table border="1"> <tr> <td></td> <td>n</td> <td>n+1</td> <td>n+2</td> </tr> <tr> <td>bit/</td> <td>b</td> <td>a</td> <td>f</td> </tr> <tr> <td>BP</td> <td>1</td> <td>DP</td> <td>e</td> </tr> <tr> <td></td> <td>2</td> <td>c</td> <td>g</td> </tr> <tr> <td></td> <td>3</td> <td>x</td> <td>x</td> </tr> </table>		n	n+1	n+2	bit/	b	a	f	BP	1	DP	e		2	c	g		3	x	x	<table border="1"> <tr> <td colspan="2">MSB</td> <td colspan="5">LSB</td> </tr> <tr> <td>b</td> <td>DP</td> <td>c</td> <td>a</td> <td>d</td> <td>g</td> <td>f</td> <td>e</td> </tr> </table>	MSB		LSB					b	DP	c	a	d	g	f	e																												
	n	n+1	n+2																																																																
bit/	b	a	f																																																																
BP	1	DP	e																																																																
	2	c	g																																																																
	3	x	x																																																																
MSB		LSB																																																																	
b	DP	c	a	d	g	f	e																																																												
1 : 4 multiplex			<table border="1"> <tr> <td></td> <td>n</td> <td>n+1</td> </tr> <tr> <td>bit/</td> <td>a</td> <td>f</td> </tr> <tr> <td>BP</td> <td>1</td> <td>c</td> </tr> <tr> <td></td> <td>2</td> <td>b</td> </tr> <tr> <td></td> <td>3</td> <td>DP</td> </tr> </table>		n	n+1	bit/	a	f	BP	1	c		2	b		3	DP	<table border="1"> <tr> <td colspan="2">MSB</td> <td colspan="5">LSB</td> </tr> <tr> <td>a</td> <td>c</td> <td>b</td> <td>DP</td> <td>f</td> <td>e</td> <td>g</td> <td>d</td> </tr> </table>	MSB		LSB					a	c	b	DP	f	e	g	d																																	
	n	n+1																																																																	
bit/	a	f																																																																	
BP	1	c																																																																	
	2	b																																																																	
	3	DP																																																																	
MSB		LSB																																																																	
a	c	b	DP	f	e	g	d																																																												

x = data bit unchanged.

Fig 3



3. I²C-bus protocol

I²C-bus slave addresses (0111110) are reserved for the BL55024

The I2C-bus protocol is shown in Fig.4. The sequence is initiated with a START condition (S) from the I2C-bus master which is followed by the BL55024 slave addresses available. After acknowledgement, one or more command bytes (m) follow which define the status of the addressed BL55024. The last command byte is tagged with a cleared most significant bit, the continuation bit C. The command bytes are also acknowledged by the addressed BL55024 on the bus. After the last command byte, a series of display data bytes(n) may follow. These display bytes are stored in the display RAM at the address specified by the data pointer. Data pointer are automatically updated and the data is directed to the intended BL55024 device. After the last display byte, the I2C-bus master issues a STOP condition (P).

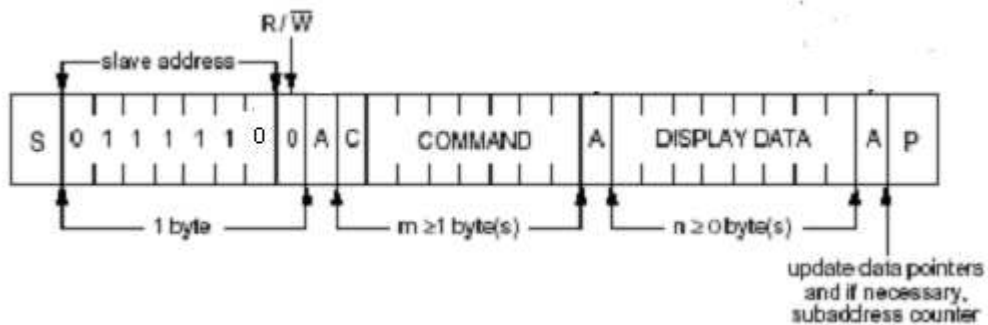
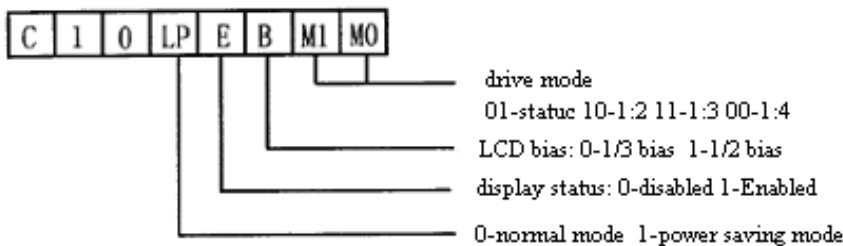

Fig 4

4. command decoder

The command decoder identifies command bytes that arrive on the I²C-bus. All available commands carry a continuation bit C in their most significant bit position. The four commands available to the BL55024 are defined in Fig 5.

A. Mode set



B. Load data pointer

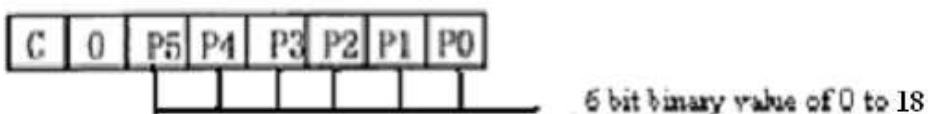

**C. Blink control****D. Device select**

Fig 5

6 Absolute Maximum Rating

Parameter	Symbol	Rating	Unit
Supply voltage	Vdd	-0.5~+6.0	V
LCD operating voltage	Vlcd	0~ Vdd	V
Input voltage	Vi	Vss-0.5~Vdd+0.5	V
Output voltage	Vo	Vlcd-0.5~Vdd+0.5	V
Vdd,Vss,Vlcd current	Idd,Iss,Ilcd	-50~+50	mA
Maximum power consumption	Ptot	400	mW
Operating temperature	Topr	-40~ +75	°C
Storage temperature	Tstg	-65~ +150	°C

7 DC Characteristic

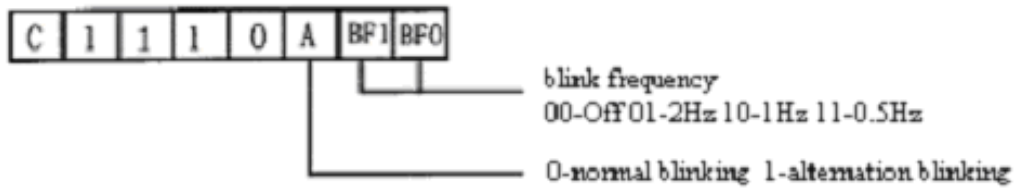
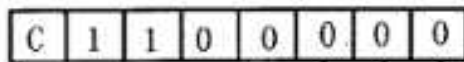
Symbol	Parameter	Test Condition	Min	Typ	Max	Unit
Vdd	IC Operating voltage		2.5	-	5.5	V
Vlcd	LCD operating voltage		0	-	Vdd-2	V
Idd1	Supply current	Vdd=5V, VLCD=0V, Normal mode, internal oscillator	-	25	50	uA
Idd2	Supply current	Vdd=5V, VLCD=0V, power saving mode, internal oscillator	-	14	30	uA
Idd3	Supply current	Vdd=3.3V, VLCD=0V, Normal mode, internal oscillator	-	16	30	uA
Idd4	Supply current	Vdd=3.3V, VLCD=0V, power saving mode, internal oscillator	-	9	15	uA
ViL	Low voltage input	SDA,SCL	Vss	-	0.3Vdd	V
ViH	High voltage input	SDA,SCL	0.7Vdd	-	6.0	V



8 AC Characteristic

Ta=25°C

Symbol	Parameter	Test Condition	Min	Typ	Max	Unit
Fclk	Oscillator frequency	Vdd=5V,normal mode	125	180	300	KHz
Fclk	Oscillator frequency	Vdd=3.3V, power saving mode	21	31	48	KHz
Tclk	Half oscillator cycle		1	-	3	uA
Tsh1	CS start hold time		5	-		us
Tsh2	SCL start hold time		5	-		us
tlow	High time		5	-		us
thig	Low time		4	-		us
thd	SCL hold time		250			ns

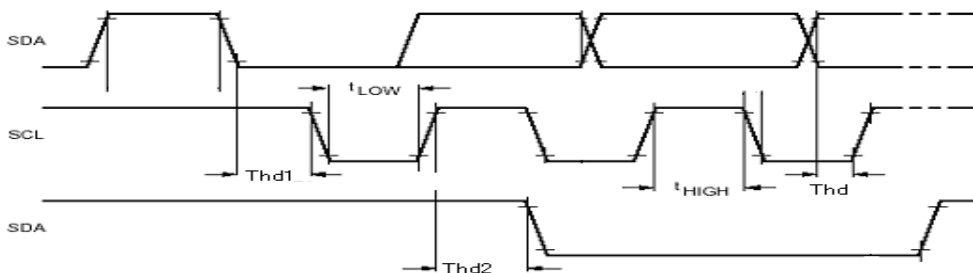

Fig 6

9 Typical Application Circuit

Note:1/ when I²C are idle mode,SDA and SCL must be connect to high level(by pull up resistor),otherwise the device maybe can not go into power saving mode.

2/ In power-saving mode, SCL frequency must be less than 21KHz.

3/ Work at 1/3 bias, Vdd – Vlcd must be more than 2.9V.

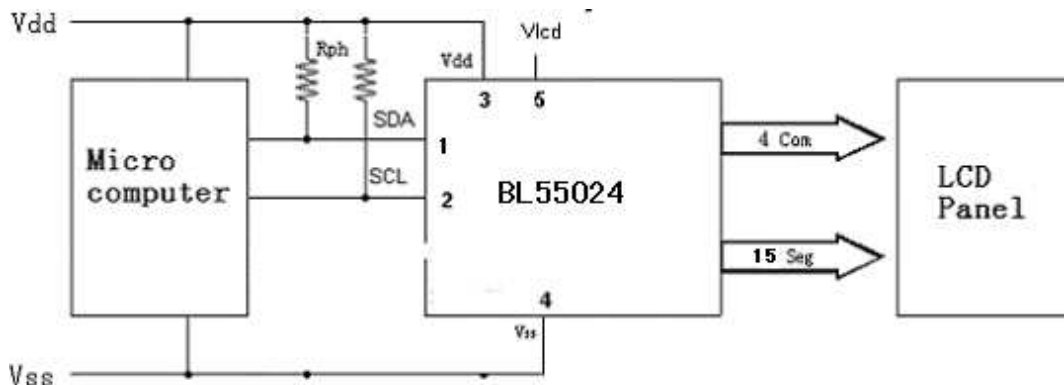

Fig 7



Shanghai Belling Corp., Ltd

BL55024

zip: 200233 Tel: 86-021-64850700 Fax: 86-021-64855865

10 Package Outline SOP24

Unit: inches (mm)

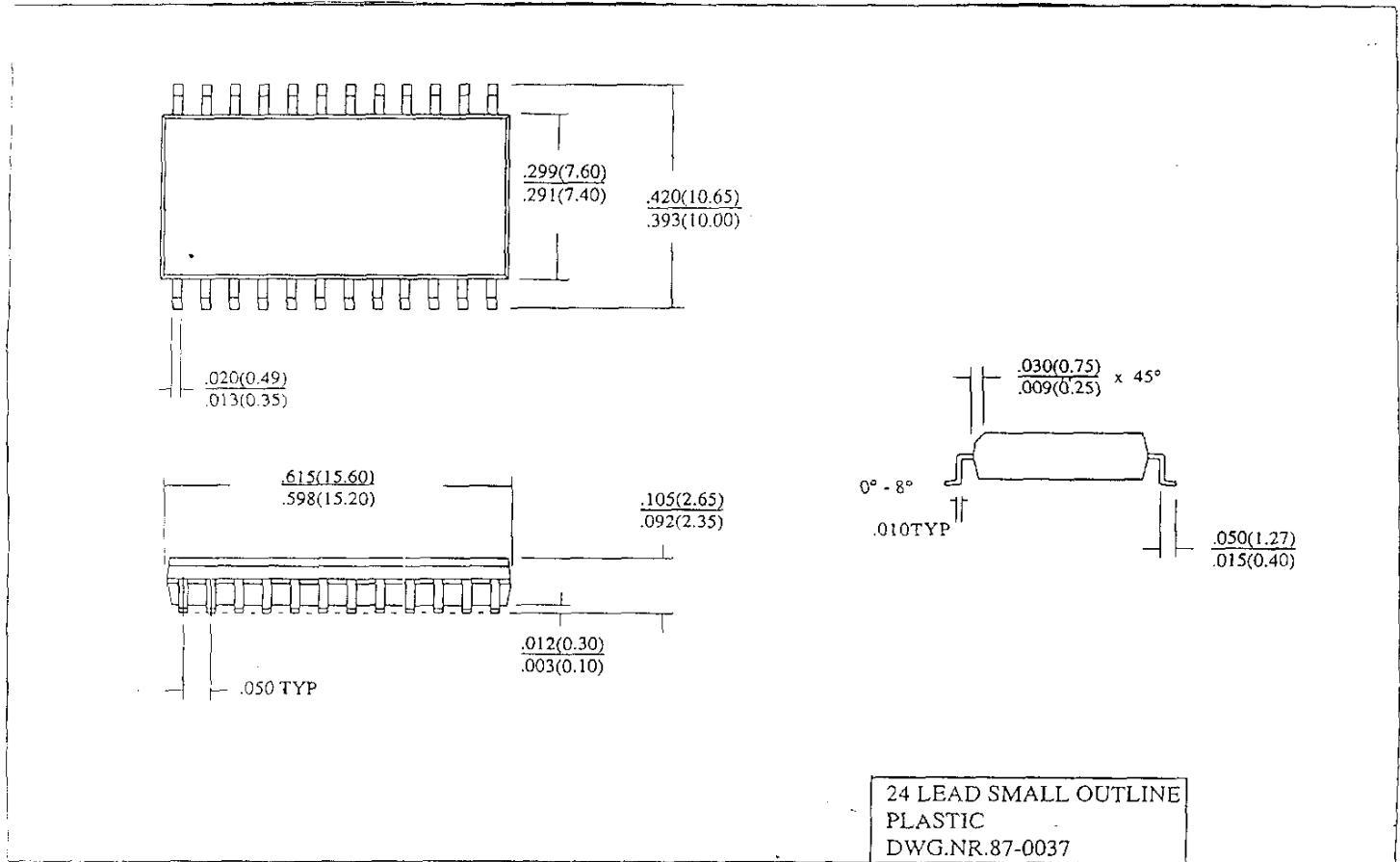

Fig 8