



Tunable Laser Module CORE

NUV614T

TEST Sample

Outline

NUV614T is Simple Tunable Single Longitudinal Mode Lasers for industrial use and R&D etc.

Features

- Single Longitudinal Mode Laser : SMSR 30dB
- Wavelength Tunable
- Flexibility

Absolute Maximum Ratings (Ta=23°C unless otherwise noted)

Item	Symbol	Absolute Maximum Ratings	Unit
Optical Output Power	P _o	65	mW
LD Reverse Voltage	V _r	2	V
Storage Temperature	T _{stg}	-20 ~ 60	deg.C
Operating Case Temperature	T _c	20 ~ 30	deg.C
Operating Relative Humidity	RH	85 *1	%

*1: Without dewfall.



Initial Electrical/Optical Characteristics

(Ta=23°C unless otherwise noted)

Item	Condition	Symbol	Min	Typ.	Max	Unit
Optical Output Power	CW, 417nm	P _o	-	-	45	mW
Threshold Current	CW, 417nm	I _{th}	-	30	-	mA
Forward Current	CW, 417nm	I _{op}	-	70	95	mA
Forward Voltage	CW, 417nm, I _F =70mA	VF	-	4.7	-	V
Spectral Side Modes	CW, I _F =70mA	SMSR	-	30	-	dB
Tuning Band Center Wavelength	CW, I _F =70mA	λ _c	416	418	420	nm
Tuning Range	CW, I _F =70mA	TR	λ _c ±5	λ _c ±6	-	nm

All figures in this specification are measured by Nichia's method and may contain measurement deviations. This model is TEST Sample for evaluation or design purpose only. Life time is not guaranteed. The above specifications are for reference purpose only and subjected to change without prior notice.

NICHIA CORPORATION

<http://www.nichia.co.jp>

◆ SALES CONTACT
TOKYO SALES OFFICE
13F Tamachi Center Building 34-7, Shiba 5-Chome, Minato-Ku, TOKYO 108-0014, JAPAN
PHONE: +81-3-3456-3108 FAX: +81-3-5440-7330

◆ TECHNICAL CONTACT
YOKOHAMA TECHNOLOGY CENTER
13-19, 3-Chome, Moriya-Cho, Kanagawa-Ku, Yokohama-shi, KANAGAWA 221-0022, JAPAN
PHONE: +81-45-444-0030 FAX: +81-45-444-0032

Typical Initial Electrical/Optical Characteristics

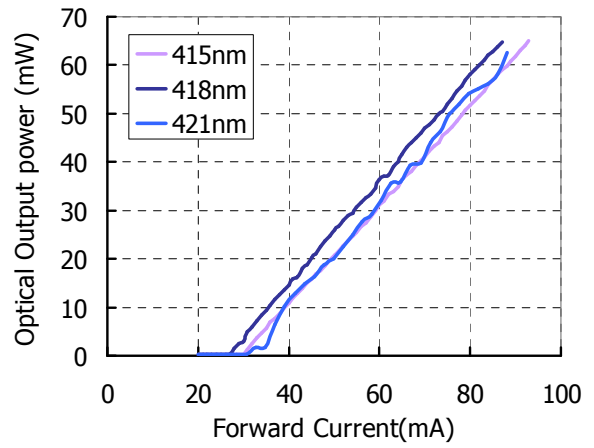
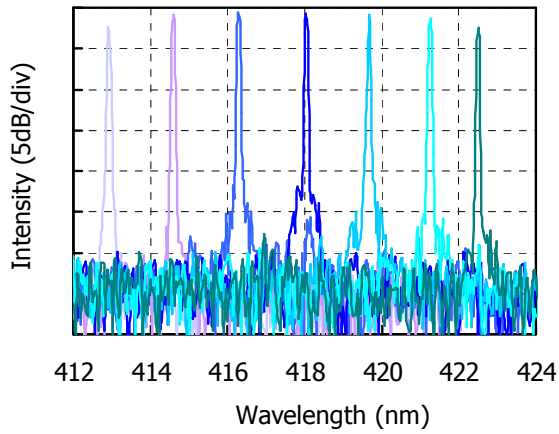

Outline Dimensions and Pin Connection

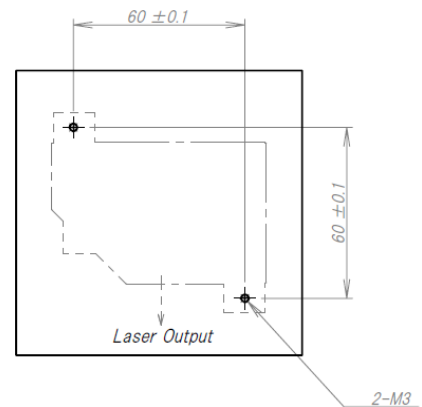
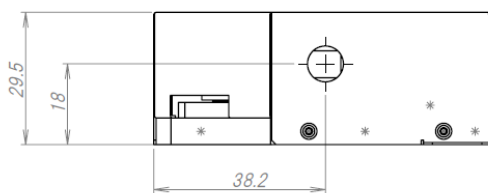
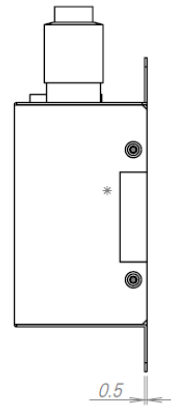
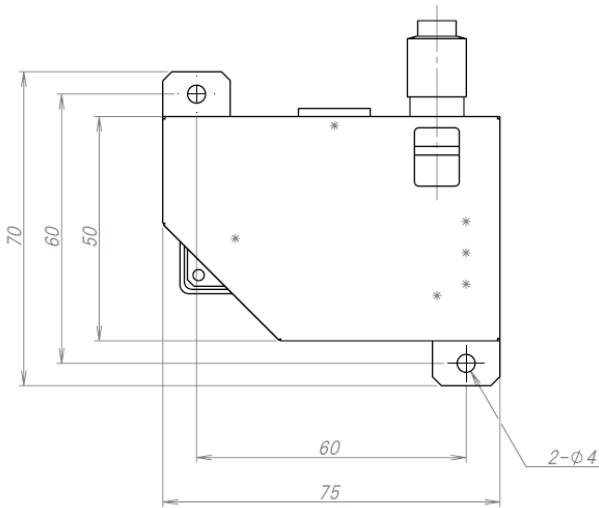
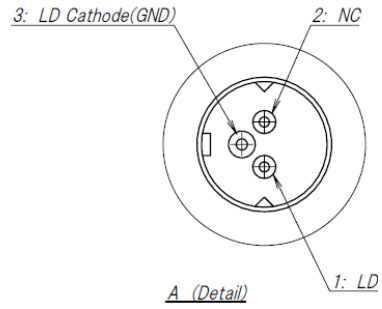
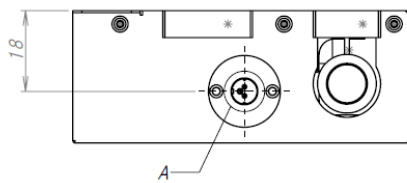

Recommended Mounting Dimension

■ Cautions

(1) Operating method

- The LD shall change its forward voltage requirement and optical output power according to temperature change. Also, the LD will require more operation current to maintain same output power as it degrades.
- The use of heat sink is strongly recommended to reduce increases in temperature.
- Confirm that electrical spike current generated by switching on and off does not exceed the maximum operating current level specified herein above as absolute max rating. Also, employ appropriate countermeasures to reduce chattering and/or overshooting in the Circuit.

VISIBLE AND INVISIBLE LASER RADIATION
AVOID EYE OR SKIN EXPOSURE TO
DIRECT OR SCATTERED RADIATION
CLASS 4 LASER PRODUCT
Wavelength 375-515nm / Maximum Power: CW >500mW
IEC60825-1: 2007

(2) Static Electricity

- Static electricity or electrical surges will reduce and degrade the reliability of the LDs. It is recommended to use a wrist strap or anti-electrostatic glove when handling the Product.

(3) Absolute Maximum Rating

- Active layer of LDs shall have high current density and generate high electric field during its operation. In order to prevent excessive damage, the LD must be operated strictly below Absolute Max Rating.

(4) Others

- Nichia LDs described in this brochure are intended to be used for ordinary electronic equipment (such as office equipment, communications equipment, measurement instruments and household appliances). Consult Nichia's sales staff in advance for information on the applications in which exceptional quality and reliability are required, particularly when the failure or malfunction of the LDs may directly jeopardize life or health (such as for airplanes, aerospace, submersible repeaters, nuclear reactor control systems, automobiles, traffic control equipment, life support systems and safety devices).
- The Purchaser must acknowledge that any LD can be failed statically and must design its equipments fail safe design. Prior to use of the LD, please confirm that the LD, as described in Nichia's specifications, meets the life expectancy needs of, and provides the features required by the Circuit and any related modules, equipment and/or systems.
- Nichia prohibit Purchaser from reverse engineering, disassembling, or taking any other steps to derive the structure or design of the LD.
- The appearance and specifications of the product may be modified for improvement without notice. The formal specifications must be exchanged and signed by both parties before large volume purchase begins.
- No unauthorized transmission or reproduction of this document, either in whole or in part, is permitted.