

High Performance Schottky Diode for Transient Suppression

Technical Data

**HSMS-2700/-2702
-270B/-270C**

Features

- Ultra-low Series Resistance for Higher Current Handling
- Picosecond Switching
- Low Capacitance
- Lead-free Option Available

Applications

RF and computer designs that require circuit protection, high-speed switching, and voltage clamping.

Package Lead Code Identification (Top View)

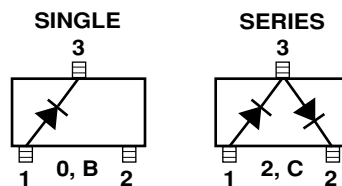

Description

The HSMS-2700 series of Schottky diodes, commonly referred to as clipping/clamping diodes, are optimal for circuit and waveshape preservation applications with high speed switching. Ultra-low series resistance, R_S , makes them ideal for protecting sensitive circuit elements against higher current transients carried on data lines. With picosecond switching, the HSMS-270x can respond to noise spikes with rise times as fast as 1 ns. Low capacitance minimizes waveshape loss that causes signal degradation.

HSMS-270x DC Electrical Specifications, $T_A = +25^\circ\text{C}^{[1]}$

Part Number HSMS-	Package Marking Code ^[2]	Lead Code	Configuration	Package	Maximum Forward Voltage V_F (mV)	Minimum Breakdown Voltage V_{BR} (V)	Typical Capacitance C_T (pF)	Typical Series Resistance R_S (Ω)	Maximum Eff. Carrier Lifetime τ (ps)
-2700	J0	0	Single	SOT-23	550 ^[3]	15 ^[4]	6.7 ^[5]	0.65	100 ^[6]
-270B		B		SOT-323 (3-lead SC-70)					
-2702	J2	2	Series	SOT-23					
-270C		C		SOT-323 (3-lead SC-70)					

Notes:

1. $T_A = +25^\circ\text{C}$, where T_A is defined to be the temperature at the package pins where contact is made to the circuit board.
2. Package marking code is laser marked.
3. $I_F = 100$ mA; 100% tested
4. $I_F = 100$ μA ; 100% tested
5. $V_F = 0$; $f = 1$ MHz
6. Measured with Karkauer method at 20 mA; guaranteed by design.

Absolute Maximum Ratings, $T_A = 25^\circ\text{C}$

Symbol	Parameter	Unit	Absolute Maximum ^[1]	
			HSMS-2700/-2702	HSMS-270B/-270C
I_F	DC Forward Current	mA	350	750
$I_{F\text{-peak}}$	Peak Surge Current (1 μs pulse)	A	1.0	1.0
P_T	Total Power Dissipation	mW	250	825
P_{INV}	Peak Inverse Voltage	V	15	15
T_J	Junction Temperature	$^\circ\text{C}$	150	150
T_{STG}	Storage Temperature	$^\circ\text{C}$	-65 to 150	-65 to 150
θ_{JC}	Thermal Resistance, junction to lead	$^\circ\text{C}/\text{W}$	500	150

Note:

1. Operation in excess of any one of these conditions may result in permanent damage to the device.

Linear and Non-linear SPICE Model

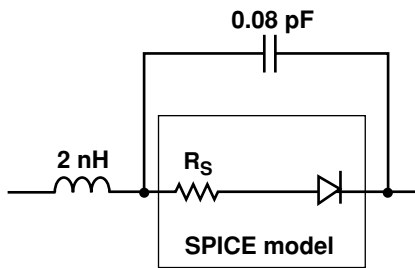

SPICE Parameters

Parameter	Unit	Value
BV	V	25
CJO	pF	6.7
EG	eV	0.55
IBV	A	10E-4
IS	A	1.4E-7
N		1.04
RS	Ω	0.65
PB	V	0.6
PT		2
M		0.5

Typical Performance

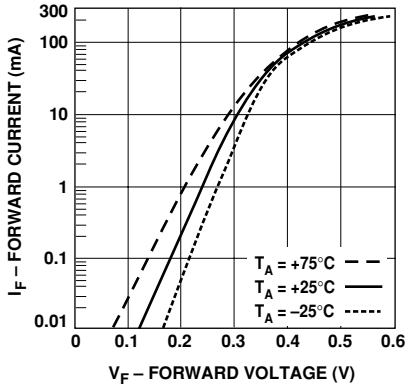

Figure 1. Forward Current vs. Forward Voltage at Temperature for HSMS-2700 and HSMS-2702.

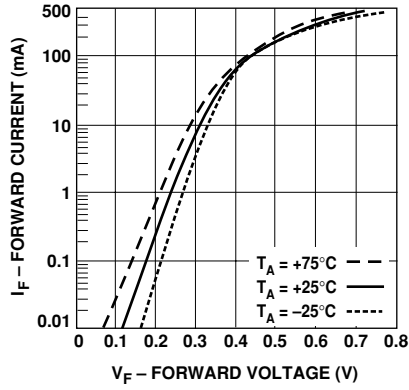

Figure 2. Forward Current vs. Forward Voltage at Temperature for HSMS-270B and HSMS-270C.

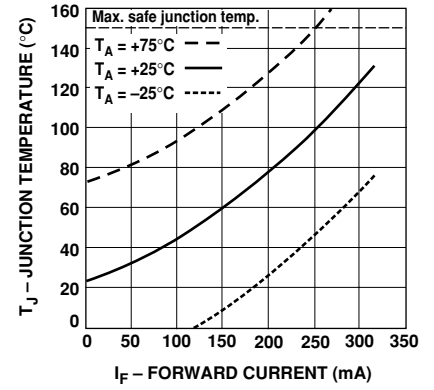

Figure 3. Junction Temperature vs. Forward Current as a Function of Heat Sink Temperature for the HSMS-2700 and HSMS-2702.
Note: Data is calculated from SPICE parameters.

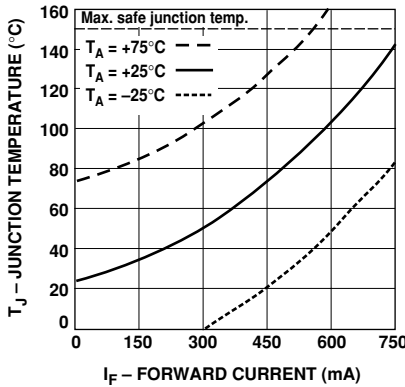

Figure 4. Junction Temperature vs. Current as a Function of Heat Sink Temperature for HSMS-270B and HSMS-270C.

Note: Data is calculated from SPICE parameters.

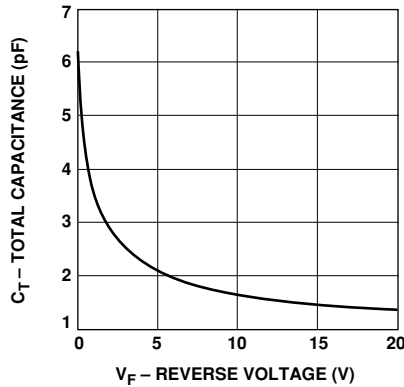
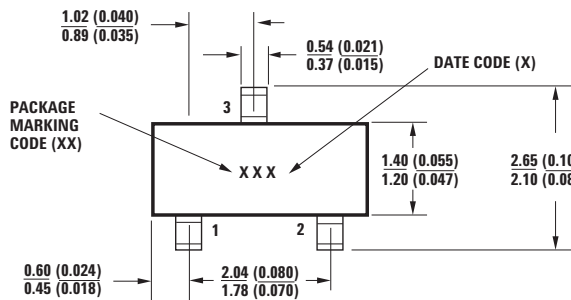
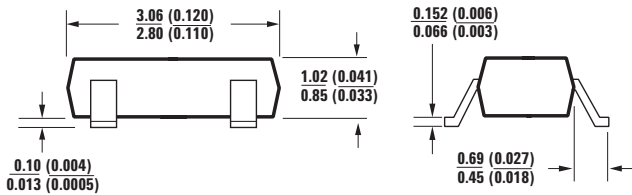

Figure 5. Total Capacitance vs. Reverse Voltage.

Package Dimensions Outline SOT-23



TOP VIEW



SIDE VIEW

END VIEW

DIMENSIONS ARE IN MILLIMETERS (INCHES)

Device Orientation For Outlines SOT-23/323

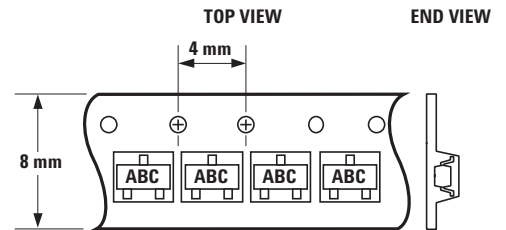
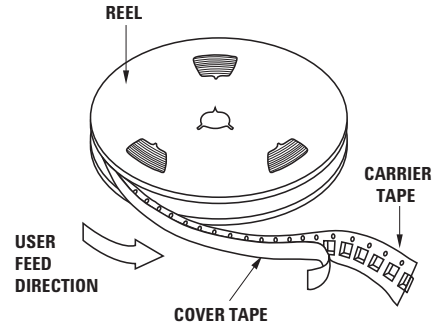

Note: "AB" represents package marking code.
"C" represents date code.

Tape Dimensions and Product Orientation For Outline SOT-23

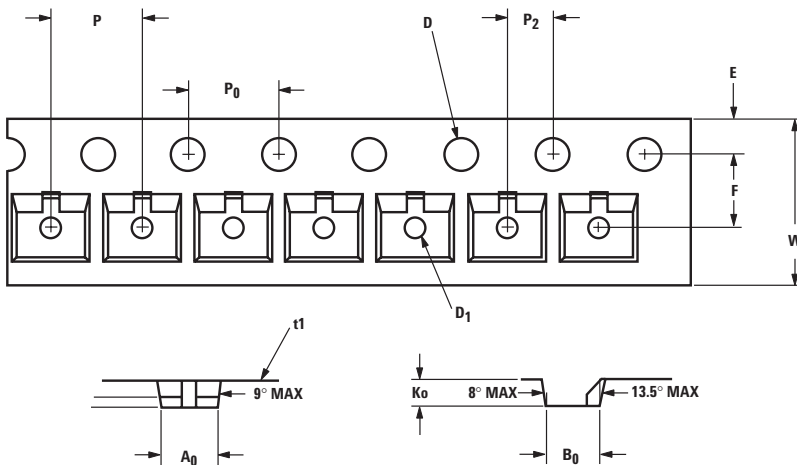

	DESCRIPTION	SYMBOL	SIZE (mm)	SIZE (INCHES)
CAVITY	LENGTH	A ₀	3.15 ± 0.10	0.124 ± 0.004
	WIDTH	B ₀	2.77 ± 0.10	0.109 ± 0.004
	DEPTH	K ₀	1.22 ± 0.10	0.048 ± 0.004
	PITCH	P	4.00 ± 0.10	0.157 ± 0.004
	BOTTOM HOLE DIAMETER	D ₁	1.00 + 0.05	0.039 ± 0.002
PERFORATION	DIAMETER	D	1.50 ± 0.10	0.059 ± 0.004
	PITCH	P ₀	4.00 ± 0.10	0.157 ± 0.004
	POSITION	E	1.75 ± 0.10	0.069 ± 0.004
CARRIER TAPE	WIDTH	W	8.00 + 0.30 - 0.10	0.315 + 0.012 - 0.004
	THICKNESS	t ₁	0.229 ± 0.013	0.009 ± 0.0005
DISTANCE BETWEEN CENTERLINE	CAVITY TO PERFORATION (WIDTH DIRECTION)	F	3.50 ± 0.05	0.138 ± 0.002
	CAVITY TO PERFORATION (LENGTH DIRECTION)	P ₂	2.00 ± 0.05	0.079 ± 0.002

Package Dimensions Outline SOT-323 (SC-70 3 Lead)

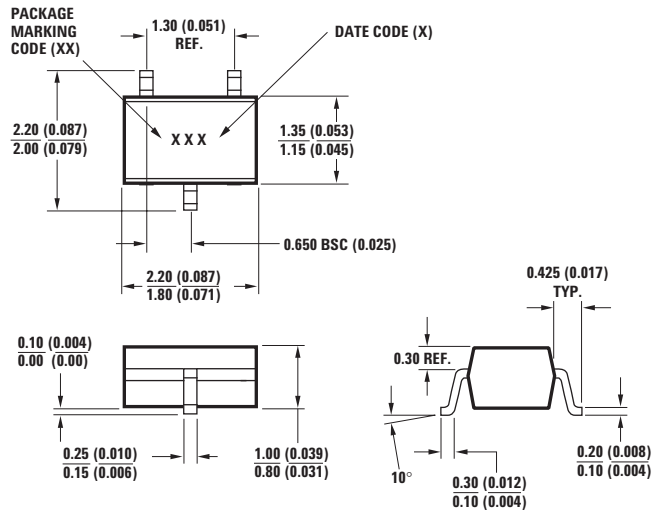

DIMENSIONS ARE IN MILLIMETERS (INCHES)

Tape Dimensions and Product Orientation For Outline SOT-323 (SC-70 3 Lead)

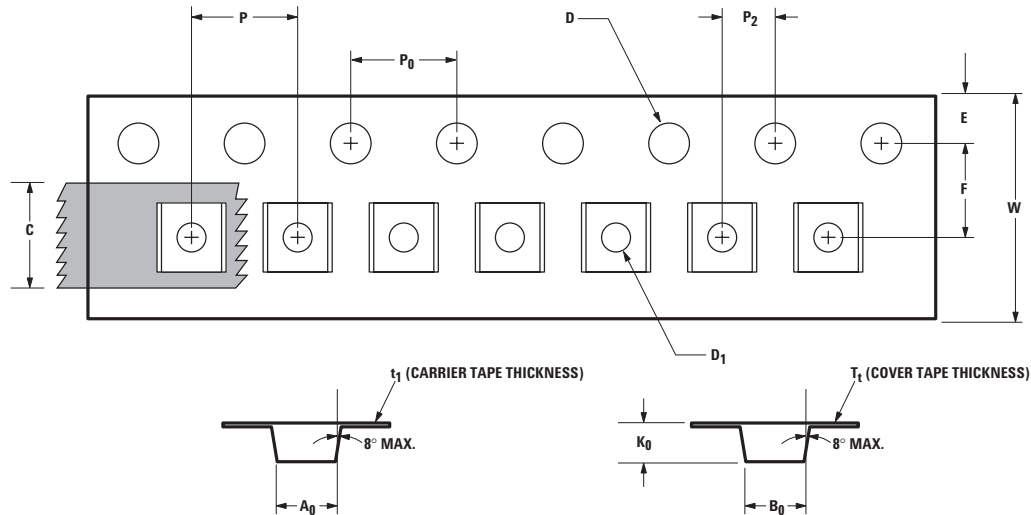

	DESCRIPTION	SYMBOL	SIZE (mm)	SIZE (INCHES)
CAVITY	LENGTH	A ₀	2.40 ± 0.10	0.094 ± 0.004
	WIDTH	B ₀	2.40 ± 0.10	0.094 ± 0.004
	DEPTH	K ₀	1.20 ± 0.10	0.047 ± 0.004
	PITCH	P	4.00 ± 0.10	0.157 ± 0.004
	BOTTOM HOLE DIAMETER	D ₁	1.00 + 0.25	0.039 + 0.010
	PERFORATION	DIAMETER	D	1.55 ± 0.05
PITCH		P ₀	4.00 ± 0.10	0.157 ± 0.004
POSITION		E	1.75 ± 0.10	0.069 ± 0.004
CARRIER TAPE	WIDTH	W	8.00 ± 0.30	0.315 ± 0.012
	THICKNESS	t ₁	0.254 ± 0.02	0.0100 ± 0.0008
COVER TAPE	WIDTH	C	5.4 ± 0.10	0.205 ± 0.004
	TAPE THICKNESS	T _t	0.062 ± 0.001	0.0025 ± 0.00004
DISTANCE	CAVITY TO PERFORATION (WIDTH DIRECTION)	F	3.50 ± 0.05	0.138 ± 0.002
	CAVITY TO PERFORATION (LENGTH DIRECTION)	P ₂	2.00 ± 0.05	0.079 ± 0.002

Applications Information

Schottky Diode Fundamentals

The HSMS-270x series of clipping/clamping diodes are Schottky devices. A Schottky device is a rectifying, metal-semiconductor contact formed between a metal and an n-doped or a p-doped semiconductor. When a metal-semiconductor junction is formed, free electrons flow across the junction from the semiconductor and fill the free-energy states in the metal. This flow of electrons creates a depletion or potential across the junction. The difference in energy levels between semiconductor and metal is called a Schottky barrier.

P-doped, Schottky-barrier diodes excel at applications requiring ultra low turn-on voltage (such as zero-biased RF detectors). But their very low, breakdown-voltage and high series-resistance make them unsuitable for the clipping and clamping applications involving high forward currents and high reverse voltages. Therefore, this discussion will focus entirely on n-doped Schottky diodes.

Under a forward bias (metal connected to positive in an n-doped Schottky), or forward voltage, V_F , there are many electrons with enough thermal energy to cross the barrier potential into the metal. Once the applied bias exceeds the built-in potential of the junction, the forward current, I_F , will increase rapidly as V_F increases.

When the Schottky diode is reverse biased, the potential barrier for electrons becomes large; hence, there is a small probability that an electron will have sufficient thermal energy to

cross the junction. The reverse leakage current will be in the nanoampere to microampere range, depending upon the diode type, the reverse voltage, and the temperature.

In contrast to a conventional p-n junction, current in the Schottky diode is carried only by majority carriers (electrons). Because no minority-carrier (hole) charge storage effects are present, Schottky diodes have carrier lifetimes of less than 100 ps. This extremely fast switching time makes the Schottky diode an ideal rectifier at frequencies of 50 GHz and higher.

Another significant difference between Schottky and p-n diodes is the forward voltage drop. Schottky diodes have a threshold of typically 0.3 V in comparison to that of 0.6 V in p-n junction diodes. See Figure 6.

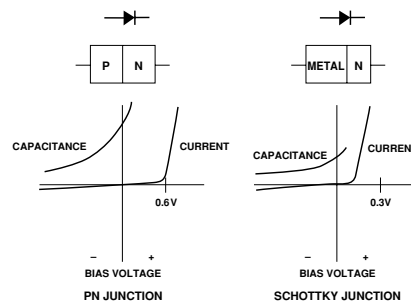

Figure 6.

Through the careful manipulation of the diameter of the Schottky contact and the choice of metal deposited on the n-doped silicon, the important characteristics of the diode (junction capacitance, C_J ; parasitic series resistance, R_S ; breakdown voltage, V_{BR} ; and forward voltage, V_F .) can be optimized for specific applications. The HSMS-270x series and HBAT-540x series of diodes are a case in point.

Both diodes have similar barrier heights; and this is indicated by corresponding values of saturation current, I_S . Yet, different contact diameters and epitaxial-layer thickness result in very different values of C_J and R_S . This is seen by comparing their SPICE parameters in Table 1.

Table 1. HSMS-270x and HBAT-540x SPICE Parameters.

Parameter	HSMS-270x	HBAT-540x
BV	25 V	40 V
CJ0	6.7 pF	3.0 pF
EG	0.55 eV	0.55 eV
IBV	10E-4 A	10E-4 A
IS	1.4E-7 A	1.0E-7 A
N	1.04	1.0
RS	0.65 Ω	2.4 Ω
PB	0.6 V	0.6 V
PT	2	2
M	0.5	0.5

At low values of $I_F \leq 1$ mA, the forward voltages of the two diodes are nearly identical. However, as current rises above 10 mA, the lower series resistance of the HSMS-270x allows for a much lower forward voltage. This gives the HSMS-270x a much higher current handling capability. The trade-off is a higher value of junction capacitance. The forward voltage and current plots illustrate the differences in these two Schottky diodes, as shown in Figure 7.

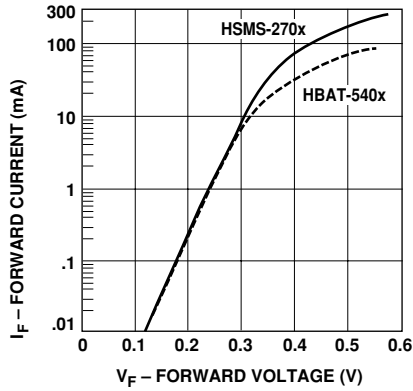

Figure 7. Forward Current vs. Forward Voltage at 25°C.

Because the automatic, pick-and-place equipment used to assemble these products selects dice from adjacent sites on the wafer, the two diodes which go into the HSMS-2702 or HSMS-270C (series pair) are closely matched — without the added expense of testing and binning.

Current Handling in Clipping/Clamping Circuits

The purpose of a clipping/clamping diode is to handle high currents, protecting delicate circuits downstream of the diode. Current handling capacity is determined by two sets of characteristics, those of the chip or device itself and those of the package into which it is mounted.

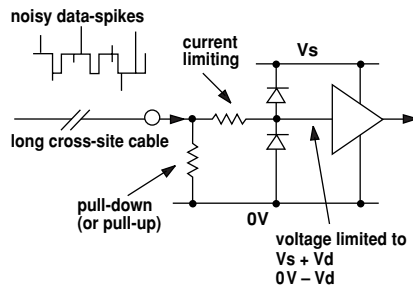

Figure 8. Two Schottky Diodes Are Used for Clipping/Clamping in a Circuit.

Consider the circuit shown in Figure 8, in which two Schottky diodes are used to protect a circuit from noise spikes on a stream of digital data. The ability of the diodes to limit the voltage spikes is related to their ability to sink the associated current spikes. The importance of current handling capacity is shown in Figure 9, where the forward voltage generated by a forward current is compared in two diodes.

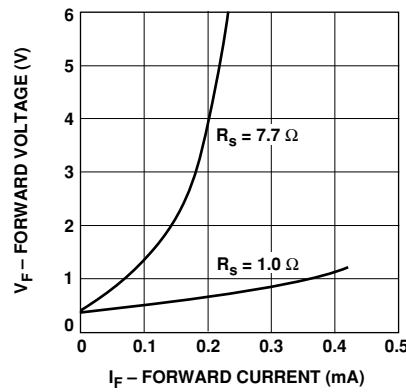

Figure 9. Comparison of Two Diodes.

The first is a conventional Schottky diode of the type generally used in RF circuits, with an R_S of 7.7 Ω . The second is a Schottky diode of identical characteristics, save the R_S of 1.0 Ω . For the conventional diode, the relatively high value of R_S causes the voltage across the diode's terminals to rise as current increases. The power dissipated in the diode heats the junction, causing R_S to climb, giving rise to a runaway thermal condition. In the second diode with low R_S , such heating does not take place and the voltage across the diode terminals is maintained at a low limit even at high values of current.

Maximum reliability is obtained in a Schottky diode when the steady state junction temperature is maintained at or below 150°C, although brief excursions to higher junction temperatures can be tolerated with no significant impact upon mean-time-to-failure, MTTF. In order to compute the junction temperature, Equations (1) and (3) below must be simultaneously solved.

$$I_F = I_S \left[e^{\frac{11600 (V_F - I_F R_S)}{n T_J}} - 1 \right] \quad (1)$$

$$I_S = I_0 \left(\frac{T_J}{298} \right)^{\frac{2}{n}} e^{-4060 \left(\frac{1}{T_J} - \frac{1}{298} \right)} \quad (2)$$

$$T_J = V_F I_F \theta_{JC} + T_A \quad (3)$$

where:

I_F = forward current

I_S = saturation current

V_F = forward voltage

R_S = series resistance

T_J = junction temperature

I_0 = saturation current at 25°C

n = diode ideality factor

θ_{JC} = thermal resistance from junction to case (diode lead)

= $\theta_{\text{package}} + \theta_{\text{chip}}$

T_A = ambient (diode lead) temperature

Equation (1) describes the forward V-I curve of a Schottky diode. Equation (2) provides the value for the diode's saturation current, which value is plugged into (1). Equation (3) gives the value of junction temperature as a function of power dissipated in the diode and ambient (lead) temperature.

The key factors in these equations are: R_S , the series resistance of the diode where heat is generated under high current conditions; θ_{chip} , the chip thermal resistance of the Schottky die; and $\theta_{package}$, or the package thermal resistance.

R_S for the HSMS-270x family of diodes is typically 0.7Ω and is the lowest of any Schottky diode available from Agilent. Chip thermal resistance is typically $40^\circ\text{C}/\text{W}$; the thermal resistance of the iron-alloy-leadframe, SOT-23 package is typically $460^\circ\text{C}/\text{W}$; and the thermal resistance of the copper-leadframe, SOT-323 package is typically $110^\circ\text{C}/\text{W}$. The impact of package thermal

resistance on the current handling capability of these diodes can be seen in Figures 3 and 4. Here the computed values of junction temperature vs. forward current are shown for three values of ambient temperature. The SOT-323 products, with their copper leadframes, can safely handle almost twice the current of the larger SOT-23 diodes. Note that the term "ambient temperature" refers to the temperature of the diode's leads, not the air around the circuit board. It can be seen that the HSMS-270B and HSMS-270C products in the SOT-323 package will safely withstand a steady-state forward current of 550 mA when the

diode's terminals are maintained at 75°C .

For pulsed currents and transient current spikes of less than one microsecond in duration, the junction does not have time to reach thermal steady state. Moreover, the diode junction may be taken to temperatures higher than 150°C for short time-periods without impacting device MTTF. Because of these factors, higher currents can be safely handled. The HSMS-270x family has the highest current handling capability of any Agilent diode.

Part Number Ordering Information

Part Number	No. of Devices	Container
HSMS-2700-BLK	100	Antistatic Bag
HSMS-2700-TR1	3,000	7" Reel
HSMS-2700-TR2	10,000	13" Reel
HSMS-2702-BLK	100	Antistatic Bag
HSMS-2702-TR1	3,000	7" Reel
HSMS-2702-TR2	10,000	13" Reel
HSMS-270B-BLK	100	Antistatic Bag
HSMS-270B-TR1	3,000	7" Reel
HSMS-270B-TR2	10,000	13" Reel
HSMS-270C-BLK	100	Antistatic Bag
HSMS-270C-TR1	3,000	7" Reel
HSMS-270C-TR2	10,000	13" Reel

Note: For lead-free option, the part number will have the character "G" at the end, eg. HSMS-270x-TR2G for a 10,000 lead-free reel.

www.agilent.com/semiconductors

For product information and a complete list of distributors, please go to our web site.

For technical assistance call:

Americas/Canada: +1 (800) 235-0312 or (916) 788-6763

Europe: +49 (0) 6441 92460

China: 10800 650 0017

Hong Kong: (65) 6756 2394

India, Australia, New Zealand: (65) 6755 1939

Japan: (+81 3) 3335-8152(Domestic/International), or 0120-61-1280(Domestic Only)

Korea: (65) 6755 1989

Singapore, Malaysia, Vietnam, Thailand, Philippines, Indonesia: (65) 6755 2044

Taiwan: (65) 6755 1843

Data subject to change.

Copyright © 2004 Agilent Technologies, Inc.

Obsoletes 5968-2351E

March 24, 2004

5989-0473EN