

AP.10H.01

Specification

Part No.	AP.10H.01
Product Name	10mm SMT 25dB Active GPS Patch Antenna With Front End Saw Filter
Feature	<ul style="list-style-type: none"> Unique SMT GPS active patch Wide Input Voltage 1.8V to 3.3V Ultra low power consumption RoHS compliant

1. Introduction

The AP.10H.01 two stage 25dB active GPS patch antenna is the smallest SMT GPS high performance embedded antenna currently available in the world. Using extremely sensitive high dielectric constant powder formulation and tight process control the 10mm x 10mm x 4mm patch antenna is accurately tuned to have

its frequency band right at 1575.42MHz for GPS systems.

A patented SMT structure gives high reliability in integration. With an ultra low power consumption two stage LNA with Saw Filter , this small active patch has the performance of an ordinary active

patch, but at only a quarter of the size. This product is suited to small form factor mobile devices such as GPS Smartphones, Personal Location, Medical devices, Telematic devices and Automotive navigation and tracking. Custom gain, connector and cable versions are available.

The AP.10H consists of 2 functional blocks – the LNA and also the patch antenna.

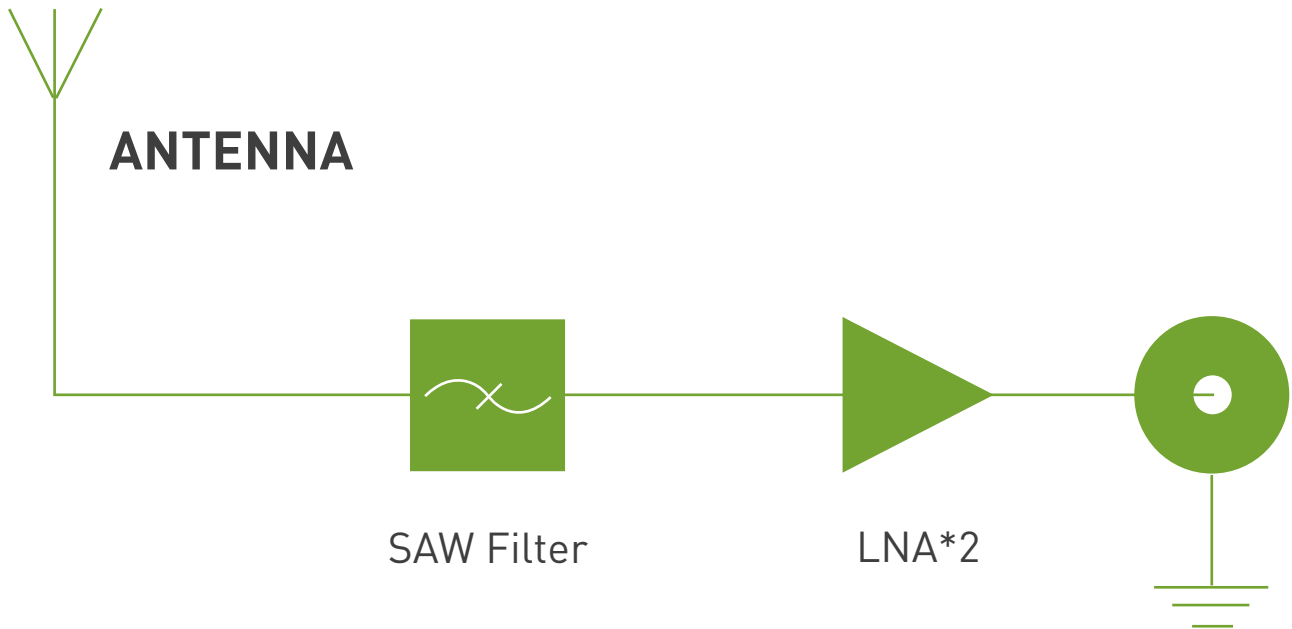

2. Specification

2.1 Patch Antenna

Parameter	Specification
Frequency	1575.42 ± 1.023MHz
Gain	Typ -10dBic @ Zenith
Impedance	50Ω
Polarization	RHCP
Axial Ratio	Max 4.0dB @ Zenith
Dimension	10mm x 10mm x 4mm (add 7.3mm depth for vertical PCB)

2.2 LNA

Parameter	Specification
Frequency	1575.42 ± 1.023MHz
Outer Band Attenuation	F0=1575.42MHz F0±30MHz 5dB min. F0±50MHz 20dB min. F0±100MHz 25dB min.
Output Impedance	50Ω
Output VSWR	2.0 Max
Pout at 1dB Gain	Min. 8dBm
Compression point	Typ. 11dBm

LNA Gain, Power Consumption and Noise Figure

Voltage	LNA Gain (Typ)	Power Consumption(mA) Typ	Noise Figure Typ
Min. 1.8V	20dB	5mA	2.7dB
Typ. 3.0V	25dB	10mA	2.5dB
Max. 3.3V	25dB	23mA	1.8dB
Input Voltage	Min. 1.8V	Typ. 3.0V	Max. 3.3V

2.3 Connection

Connection SMT via solder pads

3. LNA Gain and Out Band Rejection @3.0V

1 Active Ch/Trace 2 Response 3 Stimulus 4 Mkr/Analysis 5 Instr State

▶ Tr1 S21 Log Mag 10.00dB/ Ref -40.00dB (F2)



Cg1	Tr1	S21	>1	1.5754200 GHz	27.754 dB
Cg1	Tr1	S21	2	1.6054200 GHz	- 2.2291 dB
Cg1	Tr1	S21	3	1.5454200 GHz	20.458 dB
Cg1	Tr1	S21	4	1.6254200 GHz	- 32.691 dB
Cg1	Tr1	S21	5	1.5254200 GHz	- 10.283 dB
Cg1	Tr1	S21	6	1.6754200 GHz	- 23.132 dB
Cg1	Tr1	S21	7	1.4754200 GHz	- 21.485 dB

4. LNA Noise Figure @3.0V

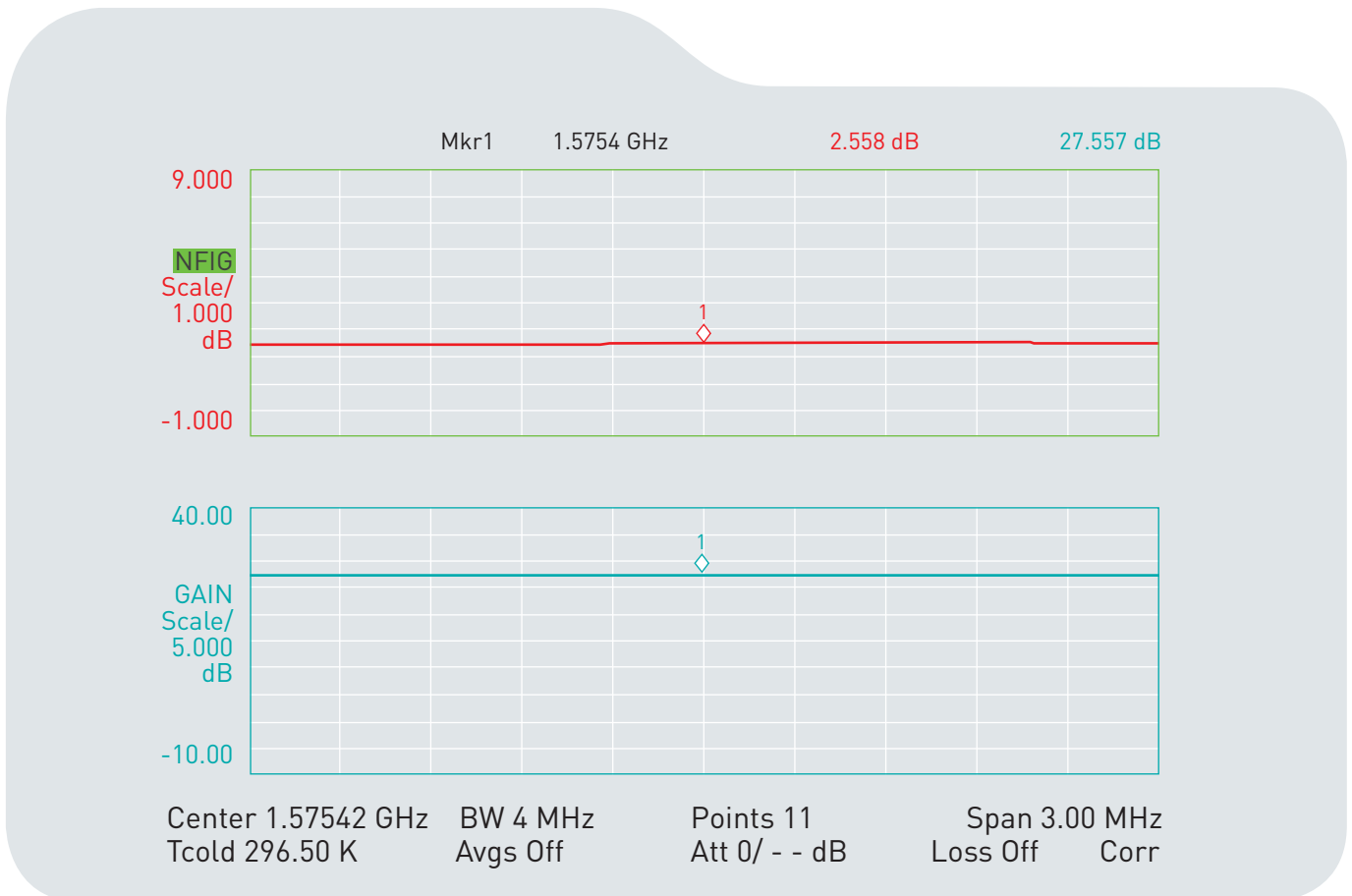

5. Total Specification (through Antenna, LNA)

Parameter	Specification
Frequency	1575.42 ± 1.023MHz
Gain @ 3.0V	15 ± 4dBic @ 90°
Output Impedance	50Ω
Polarization	RHCP
Output VSWR	Max 2.0
Operation Temperature	-40°C to + 85°C
Storage Temperature	-40°C to + 85°C
Relative Humidity	40% to 95%
Input Voltage	Min. 1.8V, Typ. 3.0V, Max. 5.5V
ESD Capability	Direct Discharge: 4KV Min.

6. Radiation Patterns

6.1 XZ Plane

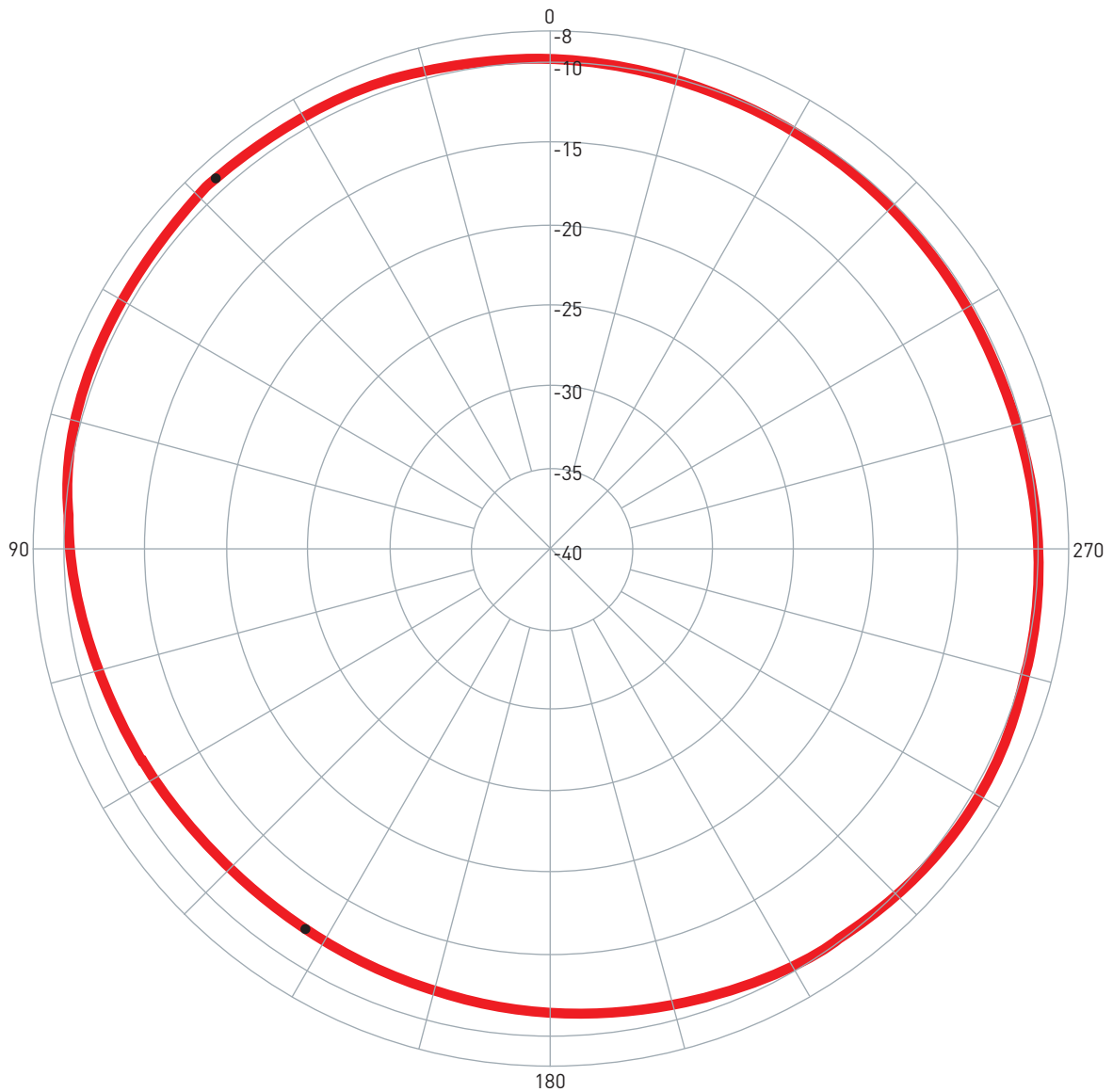

Pattern	Model No.	Test Mode	Freq (MHz)	Max Gain(dBi)	Min Gain(dBi)	Avg. Gain(dBi)	Source Polar.	Date
1	AP.10H.01	XZ	1620.00	-9.20 / 42.00	-11.99 / 147.00	-10.24	RHCP	2010/4/29

6.2 YZ Plane

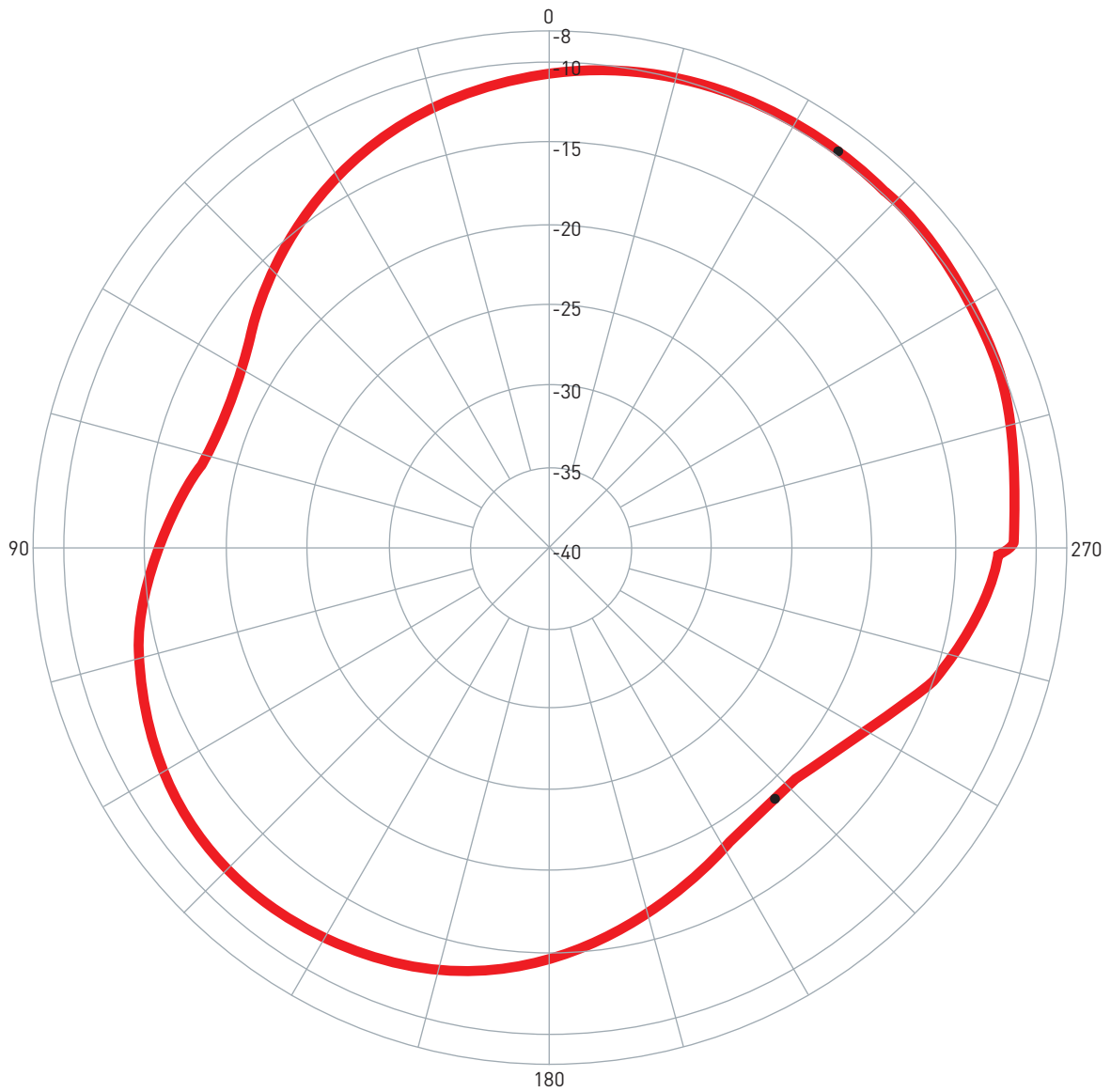

Pattern	Model No.	Test Mode	Freq (MHz)	Max Gain(dBi)	Min Gain(dBi)	Avg. Gain(dBi)	Source Polar.	Date
1	AP.10H.01	YZ	1620.00	-9.73 / 324.00	-19.18 / 222.00	-12.80	RHCP	2010/4/29

6.3 XY Plane

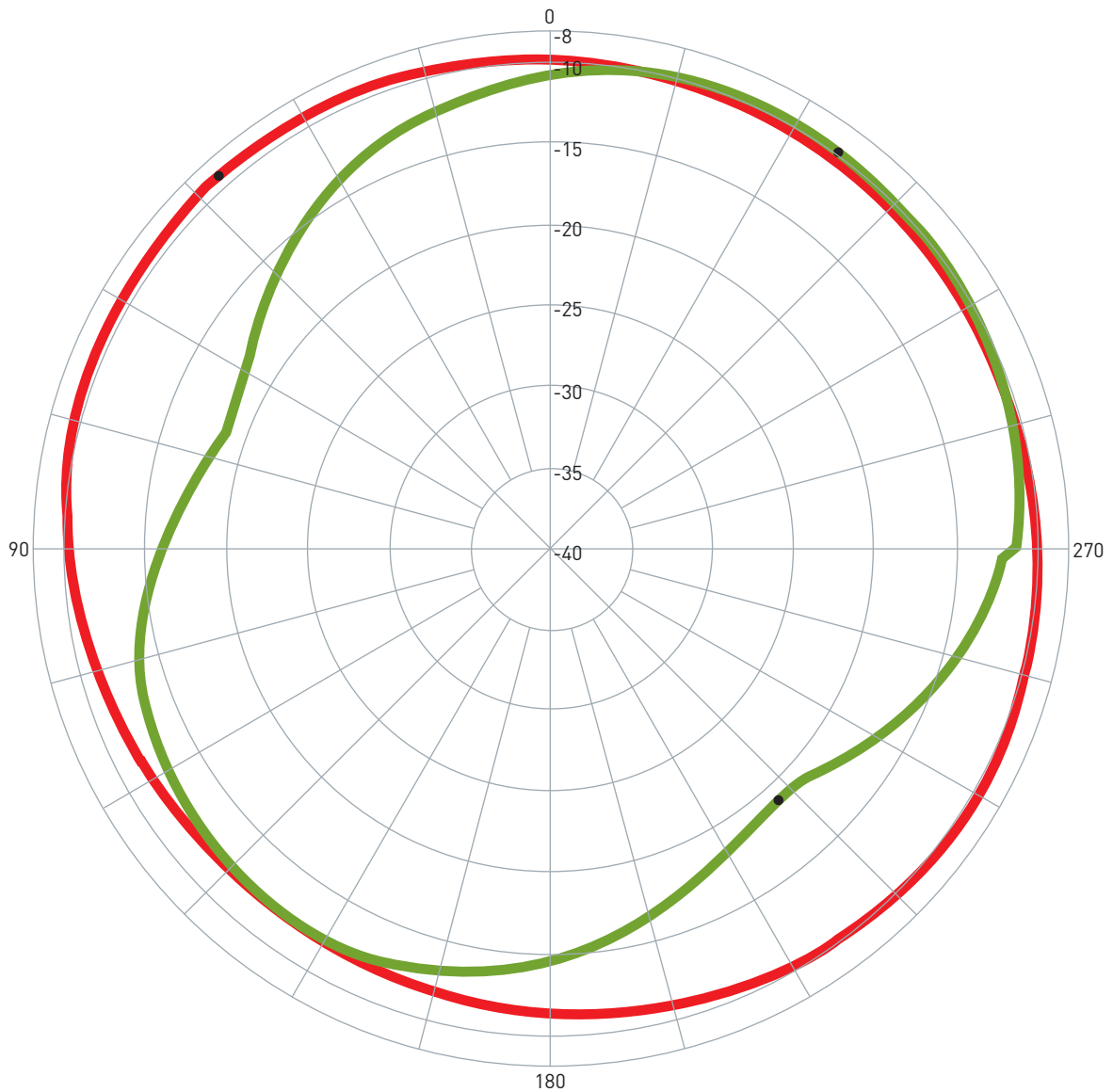



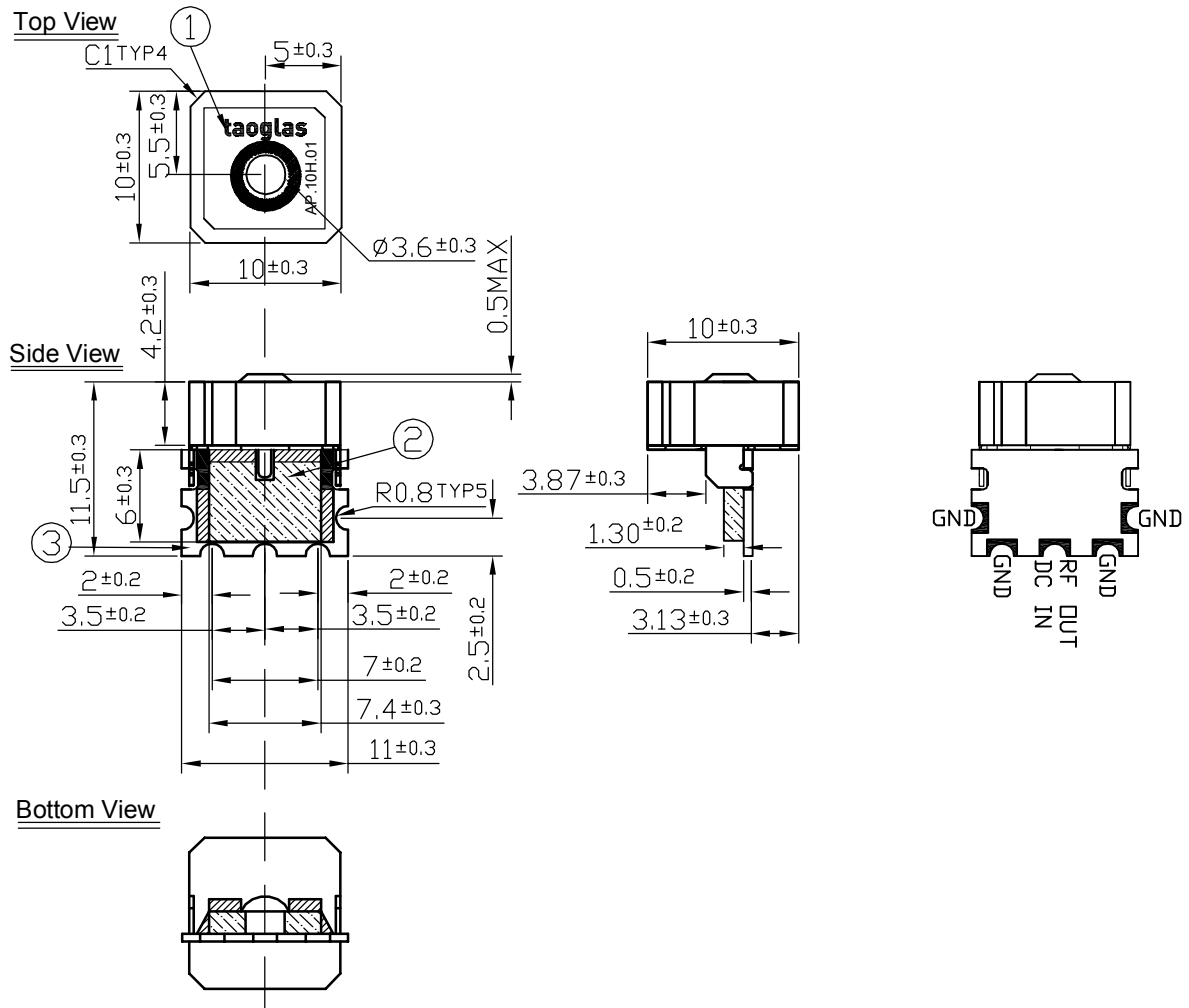

Pattern	Model No.	Test Mode	Freq (MHz)	Max Gain(dBi)	Min Gain(dBi)	Avg. Gain(dBi)	Source Polar.	Date
1	AP.10H.01	XZ	1620.00	-9.20 / 42.00	-11.99 / 147.00	-10.24	RHCP	2010/4/29
2	AP.10H.01	YZ	1620.00	-9.73 / 324.00	-19.18 / 222.00	-12.80	RHCP	2010/4/29

7. Technical Drawing



Name	P/N	Material	Finish	QTY
1 Patch (10mm x 10mm x 4.2mm)	AP.10H	Ceramic	Clear	1
2 Shielding Case		Tin (SPTE)	Tin Plated	1
3 PCB		FR4 0.6t	Green	1

NOTE:

	1. Soldered area
	2. Solder Mask Area (Green)
	3. Clearance Area
	4. Shielding Case Area
	5. Area to be solder (Pad)

7.1 PCB Footprint

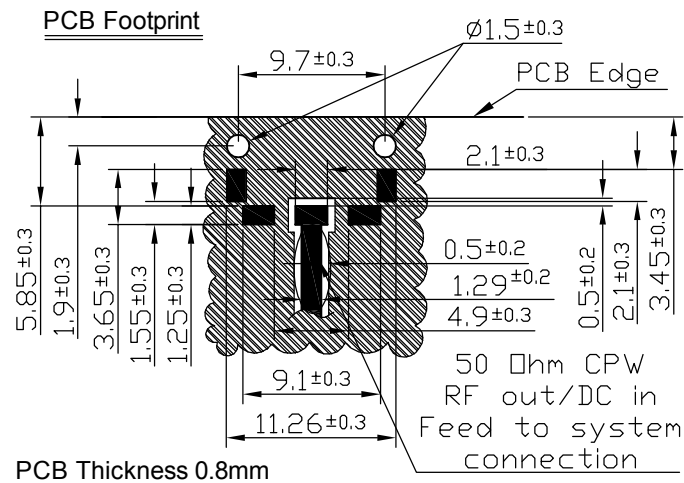

Application Assembly

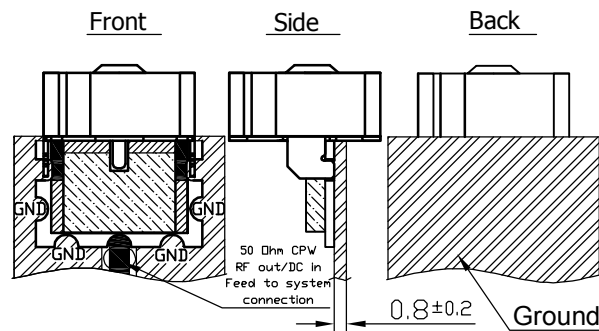

Name	P/N	Material	Finish	QTY
1 Patch (10mm x 10mm x 4.2mm)	AP.10H	Ceramic	Clear	1
2 Shielding Case		Tin (SPTE)	Tin Plated	1
3 PCB		FR4 0.6t	Green	1

NOTE:

1. Soldered area
2. Solder Mask Area (Green)
3. Clearance Area
4. Shielding Case Area
5. Area to be solder (Pad)

8. Packaging

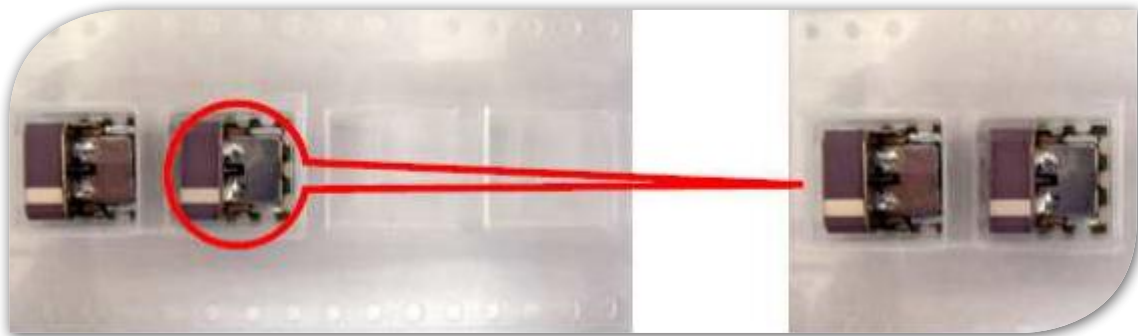

Packaged on Tape and Reel

Each Reel is packaged

Outer Carton contains 5 Reels

250 pieces per reel

Inner Carton

1250 pieces per Carton

Taoglas makes no warranties based on the accuracy or completeness of the contents of this document and reserves the right to make changes to specifications and

product descriptions at any time without notice.

Taoglas reserves all rights to this document and the information

contained herein. Reproduction, use or disclosure to third parties without express permission is strictly prohibited. Copyright © 2012, Taoglas Ltd.