



FEATURES

- ◆ Ultrawide 4 : 1 Input Range 9 – 36 VDC and 18 – 75 VDC
- ◆ Full SMD-Design
- ◆ Input Filter meets EN 55022, Class A and FCC, Level A without external Components
- ◆ Indefinite Short-Circuit Protection
- ◆ Overvoltage Protection
- ◆ I/O-Isolation 1500 VDC
- ◆ 2" x 1" Metal Package
- ◆ Insulated Baseplate
- ◆ MTBF>1000Khours
- ◆ Industry Standard Pinout
- ◆ 2 Year Product Warranty

MODEL SELECTION

WRB^①24^②12^③Z^④M^⑤D^⑥-12W(1000)^⑦

- ① Product Series
- ② Input Voltage
- ③ Output Voltage
- ④ Wide (4:1) Input Range
- ⑤ Metal Shield
- ⑥ 2" x 1" DIP Package Style
- ⑦ Rated Power(Output current)

APPLICATIONS

The WRA-ZMD-12W & WRB-ZMD-12W Series series of DC/DC converters has been designed for a wide range of applications including communications, industrial systems and battery powered mobile equipments. Key features are high power density (12W in a 2"x1"x0.4" package) and ultrawide input ranges of 9 – 36 VDC and 18 –75 VDC. Other features of this converter are internal filtering according to EN 55022, level A, safety approval to EN 60950 and UL 1950, wide operating temperature range and remote on/off (opt.).



MICRODC reserves the copyright

SELECTION GUIDE

Ordercode	Input voltage range	Output voltage	Output current max.	Efficiency typ.
WRB2403ZMD-2400	9 – 36 VDC	3,3 VDC	2400 mA	78 %
WRB2412ZMD-12W	9 – 36 VDC	12 VDC	1000 mA	84 %
WRB2415ZMD-12W	9 – 36 VDC	15 VDC	800 mA	84 %
WRA2412ZMD-12W	9 – 36 VDC	± 12 VDC	± 500 mA	84 %
WRA2415ZMD-12W	9 – 36 VDC	±15 VDC	± 400 mA	84 %
WRB4803ZMD-2400	18 – 75 VDC	3,3 VDC	2400 mA	s
WRB4812ZMD-12W	18 – 75 VDC	12 VDC	1000 mA	84 %
WRB4815ZMD-12W	18 – 75 VDC	15 VDC	800 mA	84 %
WRA4812ZMD-12W	18 – 75 VDC	± 12 VDC	± 500 mA	84 %
WRA4815ZMD-12W	18 – 75 VDC	±15 VDC	± 400 mA	84 %

Input Specifications

Input current(no load)	24 Vin models	40 mA typ.
	48 Vin models	20 mA typ.
Input current(full load)	24 Vin; 3.3 Vout models:	425 mA typ.
	24 Vin; 5 & ±5 Vout models:	510 mA typ.
	24 Vin; other output models:	600 mA typ.
	48 Vin; 3.3 Vout models:	215 mA typ.
	48 Vin; 5 & ±5 Vout models:	255 mA typ.
	48 Vin; other output models:	300 mA typ.
Surge voltage(1 sec. max.)	24 Vin models	42 V max.
	48 Vin models	84 V max.
Reverse voltage protection		1.0 A max.
Conducted noise (input)		EN 55022 level A, FCC part 15, level A

General Specifications

Temperature ranges	– Operating	– 40 °C ... + 60 °C
	– Case temperature	+ 95 °C max.
	– Storage	– 40 °C ... + 125 °C
Derating		above 60°C: 3% /°C
Humidity	non condensing	95 % rel H max.
Reliability, calculated MTBF	MIL-HDBK-217 E	> 700'000 h @ +25 °C
Isolation voltage	Input/Output	1500 VDC
Isolation capacity	Input/Output	200 pF typ
Isolation resistance	Input/Output (500 VDC)	> 1000 M Ohm
Switching frequency	fixed	400 kHz typ. (Pulse width modulation PWM)
Remote ON/OFF (optional):	ON:	2.5 ... 5.5 VDC or open circuit.
	OFF:	0 ... 0.8 VDC or short circuit pin 2 and pin 6
	OFF idle current:	10 mA max.
Safety standards:		UL 1950, EN 60950, IEC 60950 Compliance up to 60 VDC input voltage (SELV limit)
Safety approvals:		cUL/UL File E188913

Output Specifications

Voltage set accuracy		± 1 %
Regulation	- Input variation Vin min. to Vin max.	± 0.5 % max.
	- Load variation 10 – 90 %	± 0.5 % max.
Ripple and noise	20 MHz Bandwidth	50 mVpk-pk typ.
Temperature coefficient		± 0.02 % / °C
Output current limitation		>110% of Iout max. foldback
Short circuit protection		Hiccup mode, indefinite (automatic recovery)
Capacitive load	- single output models	470 µF max.
	- dual output models	100 µF max.

Physical Specifications

Case material	Steel chrome-nickel plated
Baseplate	Epoxy
Potting material	Silicon rubber (flammability to UL 94 V-0)
Weight	30 g (1.2 oz)
Soldering temperature	max. 250 °C / 10 sec.

APPLICATION NOTE

Requirement on output load

In order to ensure the product operate efficiently and reliably, in addition to a max load (namely full load), a minimum load is specified for this kind of DC/DC converter. Make sure the specified range of input voltage is not exceeded, the minimum output load no less than 10% load. If the actual load is less than the specified minimum load, the output ripple may increase sharply while its efficiency and reliability will reduce greatly. If the actual output power is very small, please add an appropriate resistor as extra loading, or contact our company for other lower output power products.

Recommended Circuit

All the WRA_ZMD-12W & WRB_ZMD-12W Series have been tested according to the following recommended testing circuit before leaving factory. This series should be tested under load (see Figure 1). If you want to further decrease the input/output ripple, you can increase capacitance properly or choose capacitors with low ESR. However, the capacitance of the output filter capacitor must be proper. If the capacitance is too big, a startup problem might arise. For every channel of output, provided the safe and reliable operation is ensured, the greatest capacitance of its filter capacitor sees (Table 1). General:

Cin: 10µF-47µF
Cout: 10µF/100mA

CTRL Terminal

When open or high impedance, the converter work well; When this pin is 'high'; the converter shutdown; It should be note that the input current (Ic) should between 5-10mA, exceeding the maximum 20mA will cause permanence damage to the converter.

The value of R Can be derived as follows :

$$R = \frac{Vc - Vd - 1.0}{Ic}$$

Input current

While using unstable power source, please ensure the output voltage and ripple voltage do not exceed indexes of the converter. The preceding power source must be able to provide for converter sufficient starting current Ip (Figure 2).

General: $I_p \leq 1.6 * I_{in-max}$

No parallel connection or plug and play

TYPICAL CHARACTERISTICS

Temperature Derating Graph

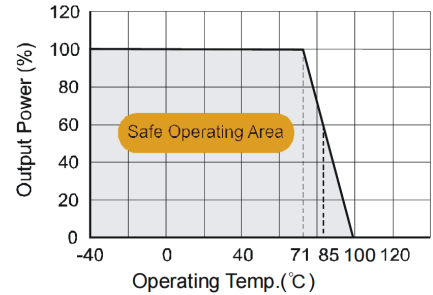

RECOMMENDED CIRCUIT

Output Graph

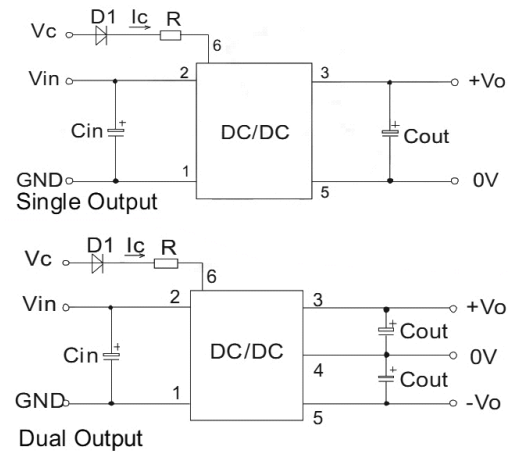

(Figure 1)

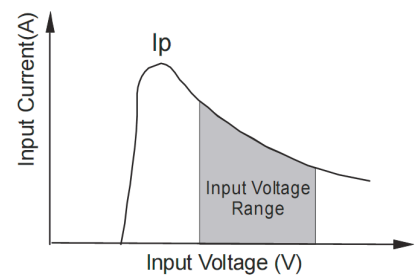

(Figure 2)

Output External Capacitor Table (Table 1)

Single Vout (VDC)	Cout (µF)	Dual Vout (VDC)	Cout (µF)
5	680	± 5	680
12	470	± 12	330
15	330	± 15	220

OUTLINE DIMENSIONS & FOOTPRINT DETAILS

MECHANICAL DIMENSIONS

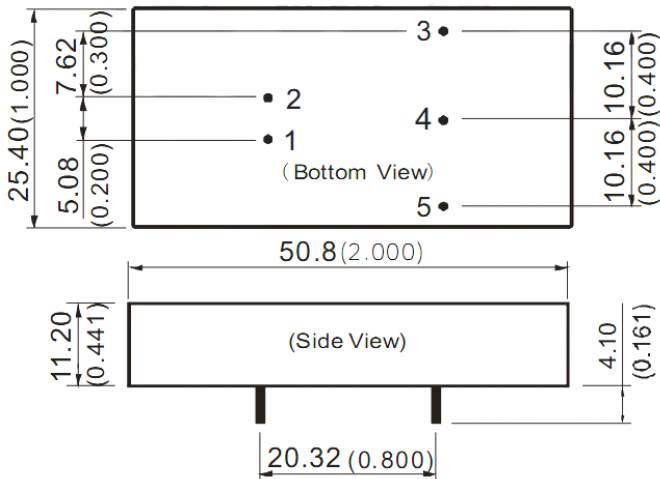

Note:
 Unit:mm[inch]
 Pin section tolerances:±0.10mm[±0.004inch]
 General tolerances:±0.25mm[±0.010inch]

FOOTPRINT DETAILS

Pin	Single	Dual
1	GND	GND
2	Vin	Vin
3	+Vo	+Vo
4	NC	0V
5	0V	-Vo

NC:No connection

When the environment temperature is higher than 71°C, the product output power should be less than 60% of the rated power.

No parallel connection or plug and play.

Use dual output simultaneously,forbid pening output pin (0V) to use as single output.

Note:

1. The load shouldn't be less than 10%, otherwise ripple will increase dramatically.
2. Operation under 10% load will not damage the converter; However, they may not meet all specification listed.
3. All specifications measured at Ta=25°C, humidity<75%, nominal input voltage and rated output load unless otherwise specified.
4. In this datasheet, all the test methods of indications are based on corporate standards.
5. Only typical models listed, other models may be different, please contact our technical person for more details.

RECOMMENDED FOOTPRINT

Dual Output

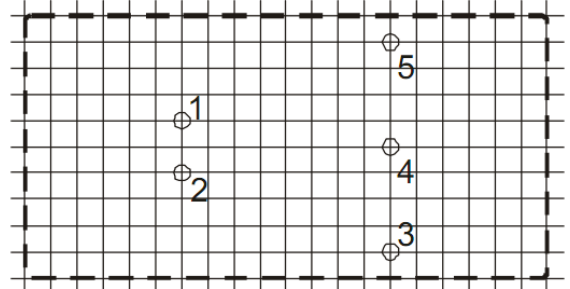

Single Output

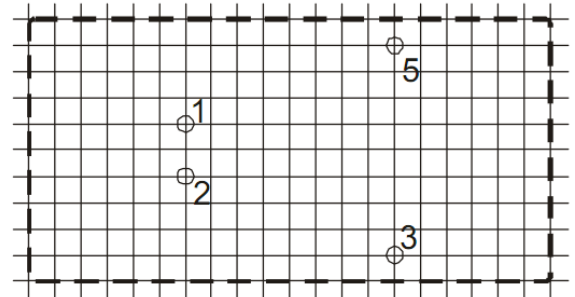

RECOMMENDED FOOTPRINT
 Top view,grid:2.54mm(0.1inch)
 diameter:1.00mm(0.039inch)

TUBE OUTLINE DIMENSIONS

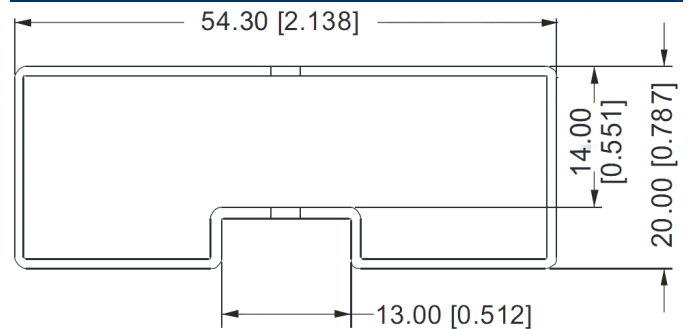

Unit :mm[inch]

General tolerances:±0.50mm[±0.020inch]

L=230mm[9.055inch] Tube Quantity: 7pcs