

**Major Ratings and Characteristics**

Characteristics	MBR340	Units
$I_{F(AV)}$ Rectangular waveform	3.0	A
$V_{RRM}$	30/40	V
$I_{FSM}$ @ $t_p = 5 \mu s$ sine	430	A
$V_F$ @ 3 Apk, $T_J = 25^\circ C$	0.6	V
$T_J$	-40 to 150	$^\circ C$

**Description/ Features**

The MBR340 axial leaded Schottky rectifier has been optimized for very low forward voltage drop, with moderate leakage. Typical applications are in switching power supplies, converters, free-wheeling diodes, and reverse battery protection.

- Low profile, axial leaded outline
- High purity, high temperature epoxy encapsulation for enhanced mechanical strength and moisture resistance
- Very low forward voltage drop
- High frequency operation
- Guard ring for enhanced ruggedness and long term reliability

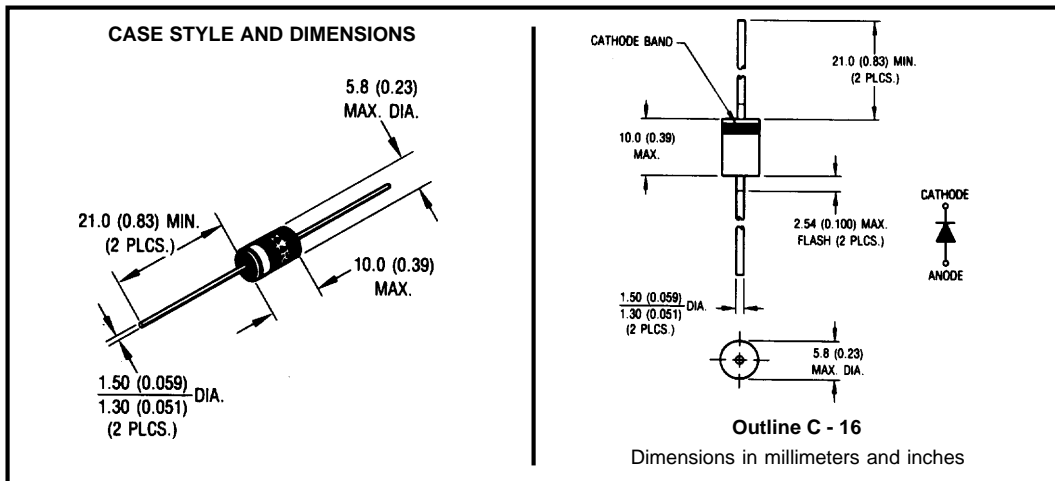

Voltage Ratings

Part number	MBR340
V <sub>R</sub> Max. DC Reverse Voltage (V)	40
V <sub>RWM</sub> Max. Working Peak Reverse Voltage (V)	

Absolute Maximum Ratings

Parameters	MBR340	Units	Conditions
I <sub>F(AV)</sub> Max. Average Forward Current * See Fig. 4	3.0	A	50% duty cycle @ T <sub>C</sub> = 92°C, rectangular wave form
I <sub>FSM</sub> Max. Peak One Cycle Non-Repetitive Surge Current * See Fig. 6	430	A	5µs Sine or 3µs Rect. pulse
	80		10ms Sine or 6ms Rect. pulse
E <sub>AS</sub> Non-Repetitive Avalanche Energy	6.0	mJ	T <sub>J</sub> = 25 °C, I <sub>AS</sub> = 1 Amps, L = 12 mH
I <sub>AR</sub> Repetitive Avalanche Current	1.0	A	Current decaying linearly to zero in 1 µsec Frequency limited by T <sub>J</sub> max. V <sub>A</sub> = 1.5 x V <sub>R</sub> typical

Electrical Specifications

Parameters	MBR340	Units	Conditions
V <sub>FM</sub> Max. Forward Voltage Drop * See Fig. 1 (1)	0.5	V	@ 1.0A
	0.6	V	@ 3.0A
	0.85	V	@ 9.4A
	0.37	V	@ 1.0A
	0.49	V	@ 3.0A
	0.72	V	@ 9.4A
I <sub>RM</sub> Max. Reverse Leakage Current * See Fig. 2 (1)	0.6	mA	T <sub>J</sub> = 25 °C
	8	mA	T <sub>J</sub> = 100 °C
	20	mA	T <sub>J</sub> = 125 °C
C <sub>T</sub> Typical Junction Capacitance	190	pF	V <sub>R</sub> = 5V <sub>DC</sub> (test signal range 100Khz to 1Mhz) 25°C
L <sub>S</sub> Typical Series Inductance	9.0	nH	Measured lead to lead 5mm from package body
dv/dt Max. Voltage Rate of Change	10000	V/µs	(Rated V <sub>R</sub> )

(1) Pulse Width < 300µs, Duty Cycle <2%

Thermal-Mechanical Specifications

Parameters	MBR340	Units	Conditions
T <sub>J</sub> Max. Junction Temperature Range(*)	-40 to 150	°C	
T <sub>stg</sub> Max. Storage Temperature Range	-40 to 150	°C	
R <sub>thJL</sub> Typical Thermal Resistance Junction to Lead (**)	28	°C/W	DC operation (* See Fig. 4)
wt Approximate Weight	1.2 (0.042)	g (oz.)	
Case Style	C - 16		

(\*)  $\frac{dP_{tot}}{dT_J} < \frac{1}{R_{th(j-a)}}$  thermal runaway condition for a diode on its own heatsink

(\*\*) Mounted 1 inch square PCB, thermal probe connected to lead 2mm from package

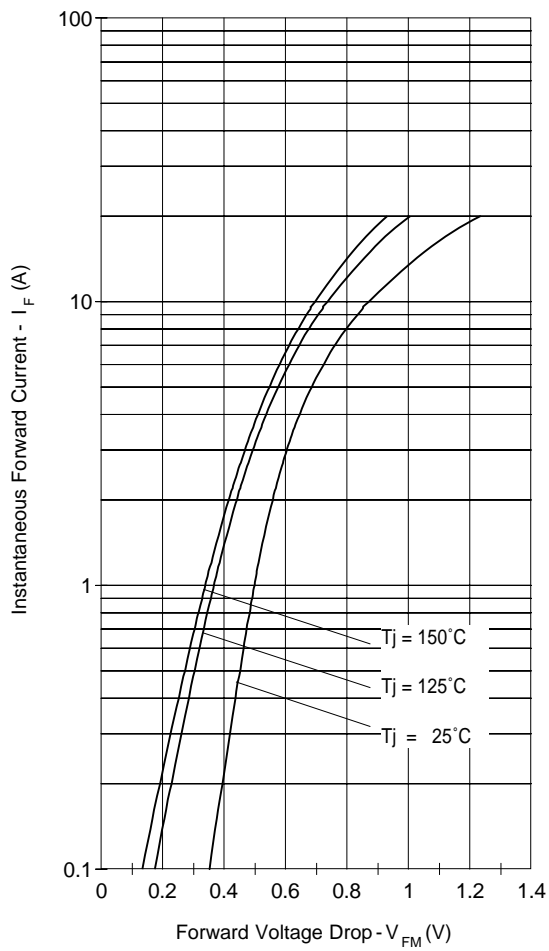

**Fig. 1 - Max. Forward Voltage Drop Characteristics**

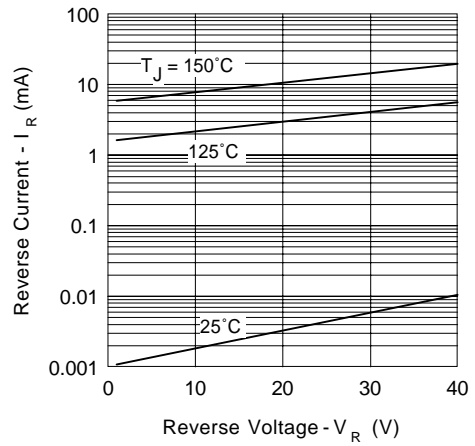

**Fig. 2 - Typical Values Of Reverse Current Vs. Reverse Voltage**

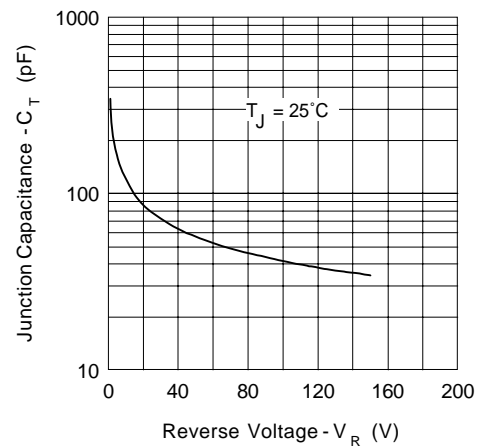

**Fig. 3 - Typical Junction Capacitance Vs. Reverse Voltage**

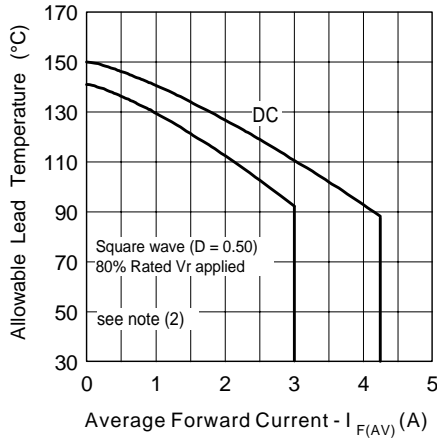

**Fig. 4 - Max. Allowable Lead Temperature Vs. Average Forward Current**

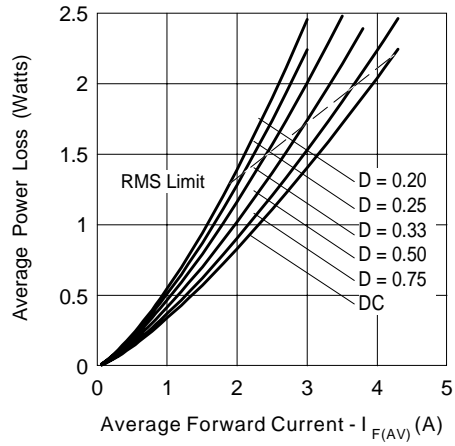

**Fig. 5 - Forward Power Loss Characteristics**

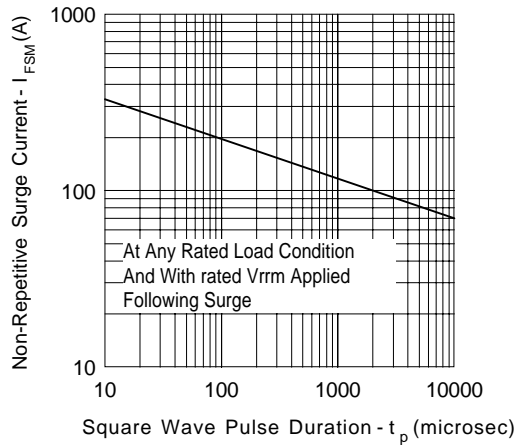

**Fig. 6 - Max. Non-Repetitive Surge Current**

(2) Formula used:  $T_C = T_J - (Pd + Pd_{REV}) \times R_{thJC}$

$Pd = \text{Forward Power Loss} = I_{F(AV)} \times V_{FM} @ (I_{F(AV)}/D)$  (see Fig. 6);

$Pd_{REV} = \text{Inverse Power Loss} = V_{R1} \times I_R (1 - D); I_R @ V_{R1} = 80\% \text{ rated } V_R$

### Ordering Information Table

<b>Device Code</b>	<b>MBR</b>	<b>3</b>	<b>40</b>	<b>TR</b>
	①	②	③	④
<b>1</b>	-	Schottky MBR Series		
<b>2</b>	-	Current Rating: 3 = 3A		
<b>3</b>	-	Voltage Rating: 40 = 40V		
<b>4</b>	-	TR = Tape & Reel package (1200 pcs)		
	-	= Box package (500 pcs)		

Data and specifications subject to change without notice.  
This product has been designed and qualified for Industrial Level.  
Qualification Standards can be found on IR's Web site.