

REPETITIVE AVALANCHE AND dv/dt RATED HEXFET® TRANSISTOR

IRHN9150
IRHN93150
JANSR2N7244U
JANSF2N7422U
(REF:MIL-PRF-19500/662)
P-CHANNEL
RAD HARD

-100 Volt, 0.073Ω, RAD HARD HEXFET

International Rectifier's P-Channel RAD HARD technology HEXFETs demonstrate excellent threshold voltage stability and breakdown voltage stability at total radiation doses as high as 3×10^5 Rads (Si). Under **identical** pre- and post-radiation test conditions, International Rectifier's P-Channel RAD HARD HEXFETs retain **identical** electrical specifications up to 1×10^5 Rads (Si) total dose. No compensation in gate drive circuitry is required. These devices are also capable of surviving transient ionization pulses as high as 1×10^{12} Rads (Si)/Sec, and return to normal operation within a few microseconds. Single Event Effect (SEE) testing of International Rectifier P-Channel RAD HARD HEXFETs has demonstrated virtual immunity to SEE failure. Since the P-Channel RAD HARD process utilizes International Rectifier's patented HEXFET technology, the user can expect the highest quality and reliability in the industry.

P-Channel RAD HARD HEXFET transistors also feature all of the well-established advantages of MOSFETs, such as voltage control, very fast switching, ease of paralleling and temperature stability of the electrical parameters. They are well-suited for applications such as switching power supplies, motor controls, inverters, choppers, audio amplifiers and high-energy pulse circuits in space and weapons environments.

Product Summary

Part Number	BV _{DSS}	R _{DS(on)}	I _D
IRHN9150	-100V	0.080Ω	-22A
IRHN93150	-100V	0.080Ω	-22A

Features:

- Radiation Hardened up to 3×10^5 Rads (Si)
- Single Event Burnout (SEB) Hardened
- Single Event Gate Rupture (SEGR) Hardened
- Gamma Dot (Flash X-Ray) Hardened
- Neutron Tolerant
- Identical Pre- and Post-Electrical Test Conditions
- Repetitive Avalanche Rating
- Dynamic dv/dt Rating
- Simple Drive Requirements
- Ease of Paralleling
- Hermetically Sealed
- Surface Mount
- Lightweight

Absolute Maximum Ratings

Pre-Irradiation

	Parameter	IRHN9150, IRHN93150	Units
I _D @ V _{GS} = -12V, T _C = 25°C	Continuous Drain Current	-22	A
I _D @ V _{GS} = -12V, T _C = 100°C	Continuous Drain Current	-14	
I _{DM}	Pulsed Drain Current ①	- 88	
P _D @ T _C = 25°C	Max. Power Dissipation	150	W
	Linear Derating Factor	1.2	W/°C
V _{GS}	Gate-to-Source Voltage	± 20	V
EAS	Single Pulse Avalanche Energy ②	500	mJ
I _{AR}	Avalanche Current ①	-22	A
EAR	Repetitive Avalanche Energy ①	15	mJ
dv/dt	Peak Diode Recovery dv/dt ③	-23	V/ns
T _J	Operating Junction	-55 to 150	
T _{STG}	Storage Temperature Range		
	Lead Temperature	300 (0.063 in. (1.6mm) from case for 10s	°C
	Weight	2.6 (typical)	g

Electrical Characteristics @ T_j = 25°C (Unless Otherwise Specified)

	Parameter	Min	Typ	Max	Units	Test Conditions
BV _{DSS}	Drain-to-Source Breakdown Voltage	-100	—	—	V	V _{GS} = 0V, I _D = -1.0mA
ΔBV _{DSS} /ΔT _J	Temperature Coefficient of Breakdown Voltage	—	-0.093	—	V/°C	Reference to 25°C, I _D = -1.0mA
R _{DS(on)}	Static Drain-to-Source On-State Resistance	—	—	0.080	Ω	V _{GS} = -12V, I _D = -14A ④
		—	—	0.085		V _{GS} = -12V, I _D = -22A
V _{GS(th)}	Gate Threshold Voltage	-2.0	—	-4.0	V	V _{DS} = V _{GS} , I _D = -1.0mA
g _{fs}	Forward Transconductance	11	—	—	S (τ)	V _{DS} > -15V, I _{DS} = -14A ④
I _{DSS}	Zero Gate Voltage Drain Current	—	—	-25	μA	V _{DS} = 0.8 x Max Rating, V _{GS} = 0V
		—	—	-250		V _{DS} = 0.8 x Max Rating V _{GS} = 0V, T _J = 125°C
I _{GSS}	Gate-to-Source Leakage Forward	—	—	-100	nA	V _{GS} = -20V
I _{GSS}	Gate-to-Source Leakage Reverse	—	—	100		V _{GS} = 20V
Q _g	Total Gate Charge	—	—	200	nC	V _{GS} = -12V, I _D = -22A
Q _{gs}	Gate-to-Source Charge	—	—	35		V _{DS} = Max Rating x 0.5
Q _{gd}	Gate-to-Drain ('Miller') Charge	—	—	48		
t _{d(on)}	Turn-On Delay Time	—	—	40	ns	V _{DD} = -50V, I _D = -22A, R _G = 2.35Ω
t _r	Rise Time	—	—	170		
t _{d(off)}	Turn-Off Delay Time	—	—	190		
t _f	Fall Time	—	—	190		
L _D	Internal Drain Inductance	—	2.0	—	nH	Measured from drain lead, 6mm (0.25 in) from package to center of die.
L _S	Internal Source Inductance	—	4.1	—		Measured from source lead, 6mm (0.25 in) from package to source bonding pad.
C _{iss}	Input Capacitance	—	4300	—	pF	V _{GS} = 0V, V _{DS} = -25V f = 1.0MHz
C _{oss}	Output Capacitance	—	1100	—		
C _{rss}	Reverse Transfer Capacitance	—	310	—		



Source-Drain Diode Ratings and Characteristics

	Parameter	Min	Typ	Max	Units	Test Conditions
I _S	Continuous Source Current (Body Diode)	—	—	-22	A	Modified MOSFET symbol showing the integrated reverse pn junction rectifier.
I _{SM}	Pulse Source Current (Body Diode) ①	—	—	-88		
V _{SD}	Diode Forward Voltage	—	—	-3.0	V	T _J = 25°C, I _S = -22A, V _{GS} = 0V ④
t _{rr}	Reverse Recovery Time	—	—	300	ns	T _J = 25°C, I _F = -22A, di/dt ≤ -100A/μs
Q _{RR}	Reverse Recovery Charge	—	—	1.5	μC	V _{DD} ≤ -50V ④
t _{on}	Forward Turn-On Time	Intrinsic turn-on time is negligible. Turn-on speed is substantially controlled by L _S + L _D .				



Thermal Resistance

	Parameter	Min	Typ	Max	Units	Test Conditions
R _{thJC}	Junction-to-Case	—	—	0.83	°C/W	soldered to a 1" square copper-clad board
R _{thJ-PCB}	Junction-to-PC board	—	6.6	—		

Radiation Performance of Rad Hard HEXFETs

International Rectifier Radiation Hardened HEXFETs are tested to verify their hardness capability. The hardness assurance program at International Rectifier comprises three radiation environments.

Every manufacturing lot is tested in a low dose rate (total dose) environment per MIL-STD-750, test method 1019 condition A. International Rectifier has imposed a standard gate condition of -12 volts per note 5 and a V_{DS} bias condition equal to 80% of the device rated voltage per note 6. Pre- and post- irradiation limits of the devices irradiated to 1×10^5 Rads (Si) are identical and are presented in Table 1, column 1, IRHN9150. Post-irradiation limits of the devices irradiated to 3×10^5 Rads (Si) are presented in Table 1, column 2, IRHN93150. The values in Table 1 will be met for either of the two low dose rate test circuits that are used. Both pre- and post-irradiation performance

are tested and specified using the same drive circuitry and test conditions in order to provide a direct comparison. It should be noted that at a radiation level of 3×10^5 Rads (Si) the only parametric limit change is $V_{GS(th)}$ maximum.

High dose rate testing may be done on a special request basis using a dose rate up to 1×10^{12} Rads (Si)/Sec (See Table 2). International Rectifier radiation hardened P-Channel HEXFETs are considered to be neutron-tolerant, as stated in MIL-PRF-19500 Group D.

International Rectifier radiation hardened P-Channel HEXFETs have been characterized in heavy ion Single Event Effects (SEE) environments. Single Event Effects characterization is shown in Table 3.

Table 1. Low Dose Rate ⑤ ⑥

Parameter	Description	IRHN9150		IRHN93150		Units	Test Conditions ⑧
		100K Rads (Si)		300K Rads (Si)			
		Min	Max	Min	Max		
BV_{DSS}	Drain-to-Source Breakdown Voltage	-100	—	-100	—	V	$V_{GS} = 0V, I_D = -1.0mA$
$V_{GS(th)}$	Gate Threshold Voltage ④	-2.0	-4.0	-2.0	-5.0		$V_{GS} = V_{DS}, I_D = -1.0mA$
I_{GSS}	Gate-to-Source Leakage Forward	—	-100	—	-100	nA	$V_{GS} = -20V$
I_{GSS}	Gate-to-Source Leakage Reverse	—	100	—	100		$V_{GS} = 20V$
I_{DSS}	Zero Gate Voltage Drain Current	—	-25	—	-25	μA	$V_{DS} = 0.8 \times \text{Max Rating}, V_{GS} = 0V$
$R_{DS(on)1}$	Static Drain-to-Source On-State Resistance One ④	—	0.080	—	0.080	Ω	$V_{GS} = -12V, I_D = -14A$
V_{SD}	Diode Forward Voltage ④	—	-3.0	—	-3.0	V	$T_C = 25^\circ C, I_S = -22A, V_{GS} = 0V$

Table 2. High Dose Rate ⑦

Parameter	Description	10^{11} Rads (Si)/sec			10^{12} Rads (Si)/sec			Units	Test Conditions
		Min	Typ	Max	Min	Typ	Max		
V_{DSS}	Drain-to-Source Voltage	—	—	-80	—	—	-80	V	Applied drain-to-source voltage during gamma-dot
I_{PP}		—	-100	—	—	100	—	A	Peak radiation induced photo-current
di/dt		—	—	-800	—	—	-160	A/ μ sec	Rate of rise of photo-current
L_1		0.1	—	—	0.5	—	—	μH	Circuit inductance required to limit di/dt

Table 3. Single Event Effects

Ion	LET (Si) (MeV/mg/cm ²)	Fluence (ions/cm ²)	Range (μm)	V_{DS} Bias (V)	V_{GS} Bias (V)
Ni	28	1×10^5	~41	-100	5

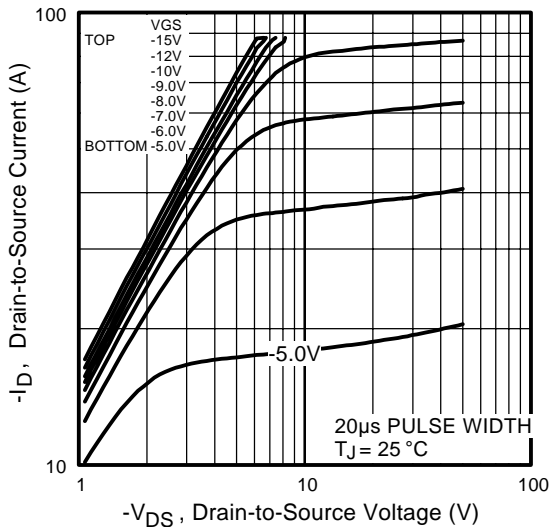

Fig 1. Typical Output Characteristics

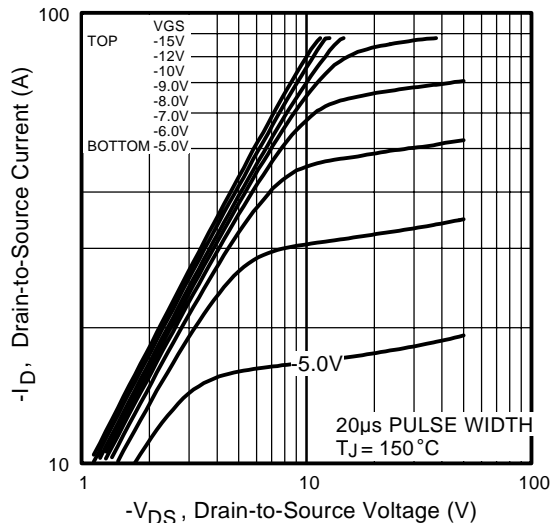

Fig 2. Typical Output Characteristics

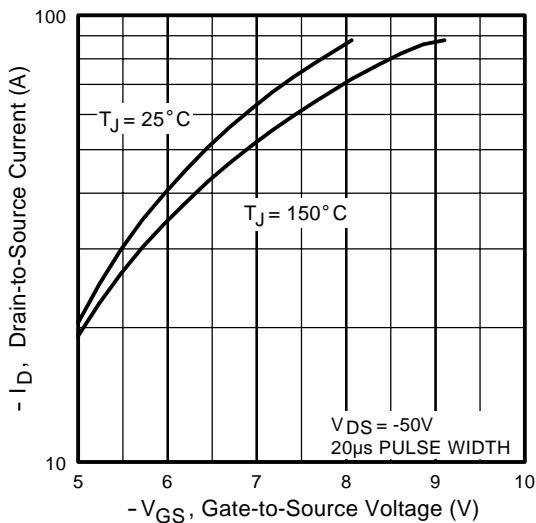

Fig 3. Typical Transfer Characteristics

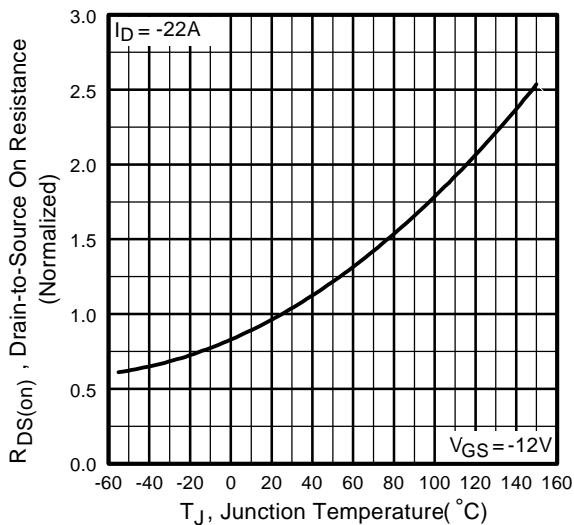

Fig 4. Normalized On-Resistance Vs. Temperature

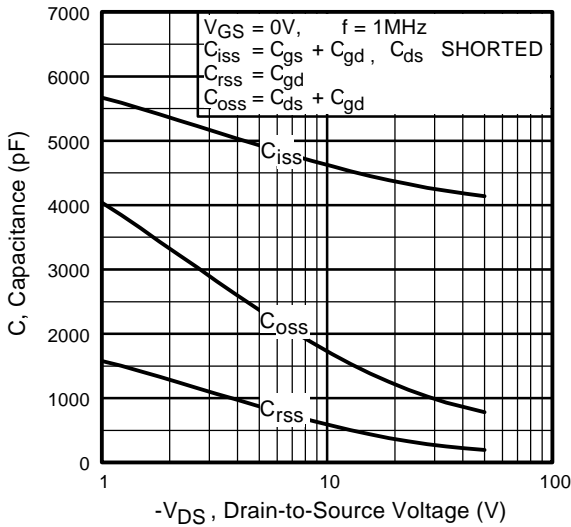

Fig 5. Typical Capacitance Vs. Drain-to-Source Voltage

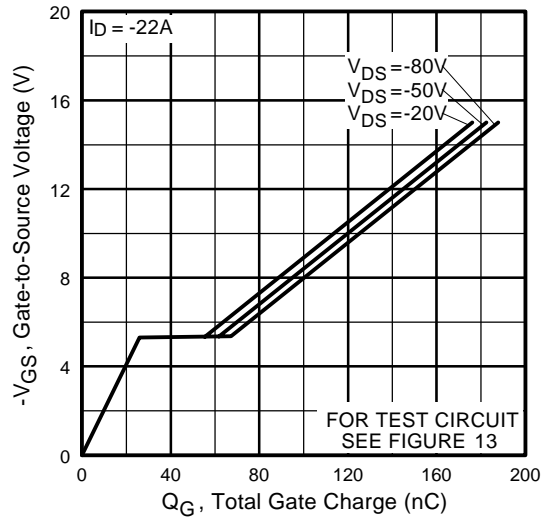

Fig 6. Typical Gate Charge Vs. Gate-to-Source Voltage

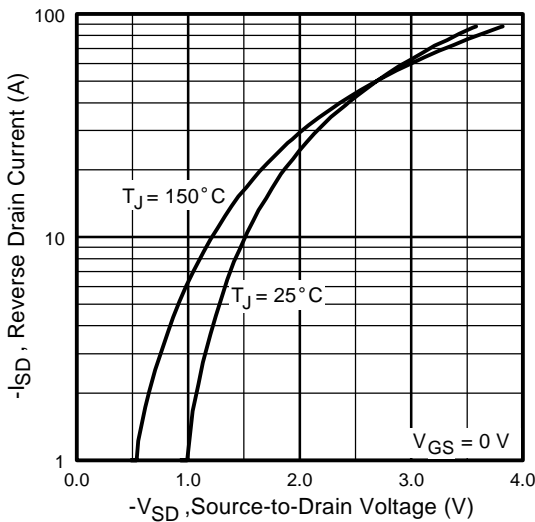

Fig 7. Typical Source-Drain Diode Forward Voltage

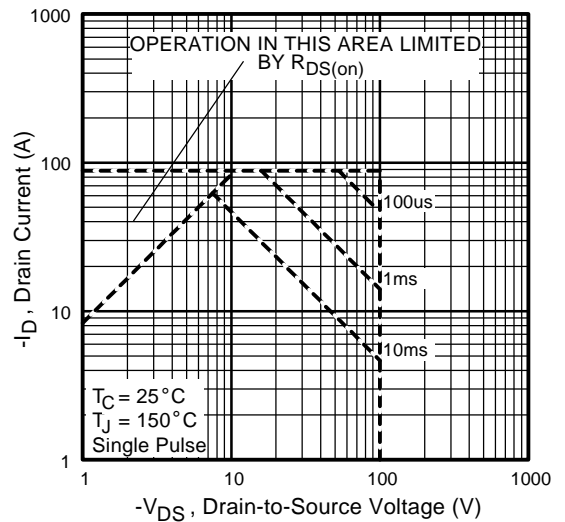

Fig 8. Maximum Safe Operating Area

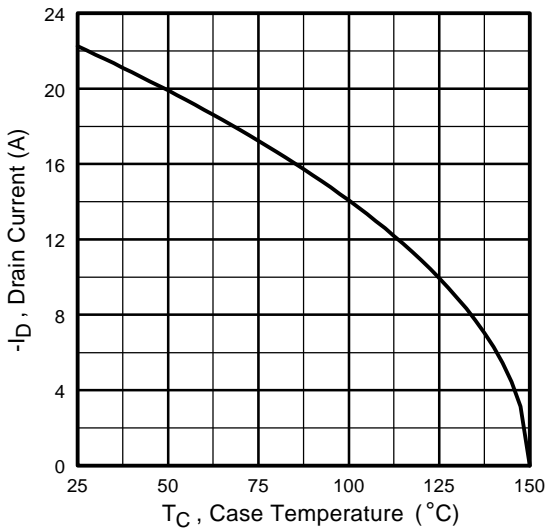

Fig 9. Maximum Drain Current Vs. Case Temperature

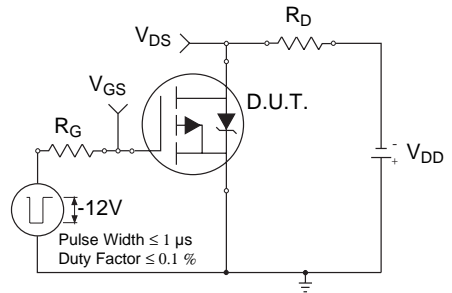

Fig 10a. Switching Time Test Circuit

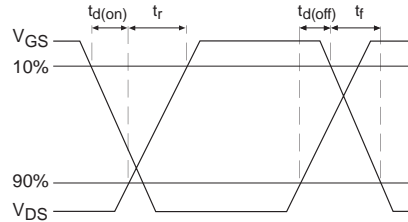

Fig 10b. Switching Time Waveforms

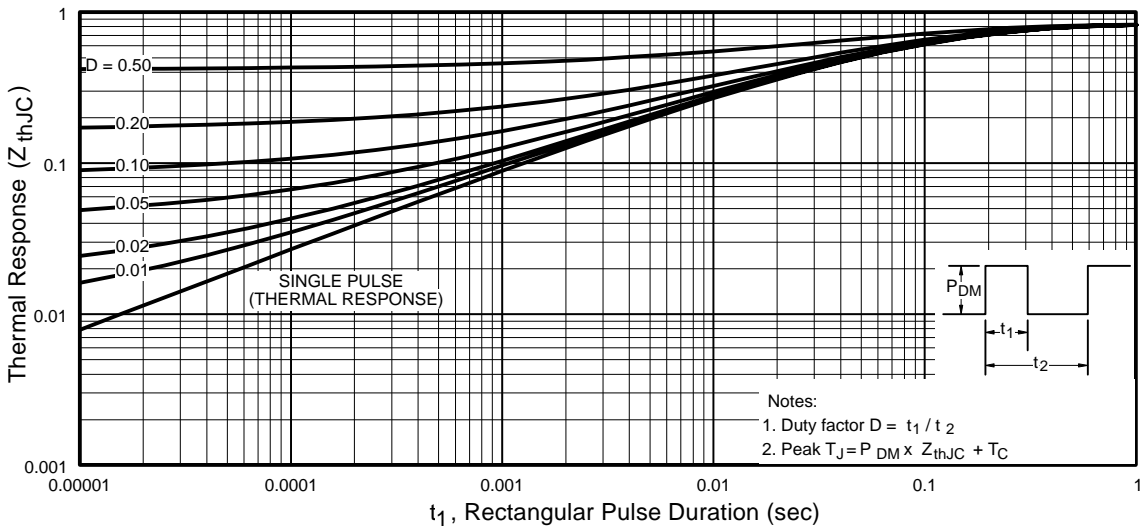

Fig 11. Maximum Effective Transient Thermal Impedance, Junction-to-Case

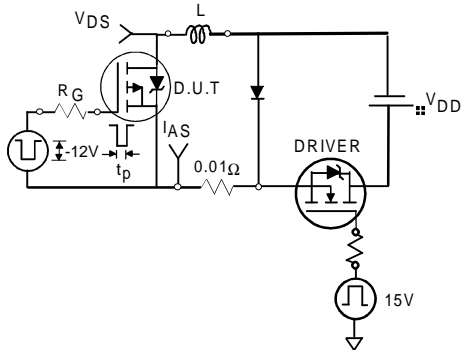

Fig 12a. Unclamped Inductive Test Circuit

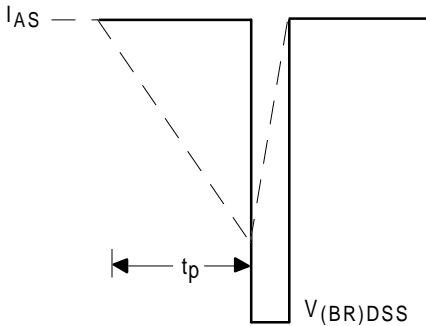

Fig 12b. Unclamped Inductive Waveforms

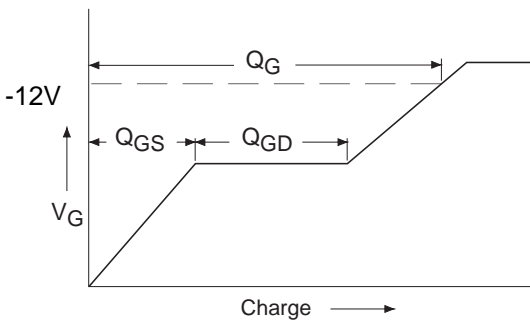

Fig 13a. Basic Gate Charge Waveform

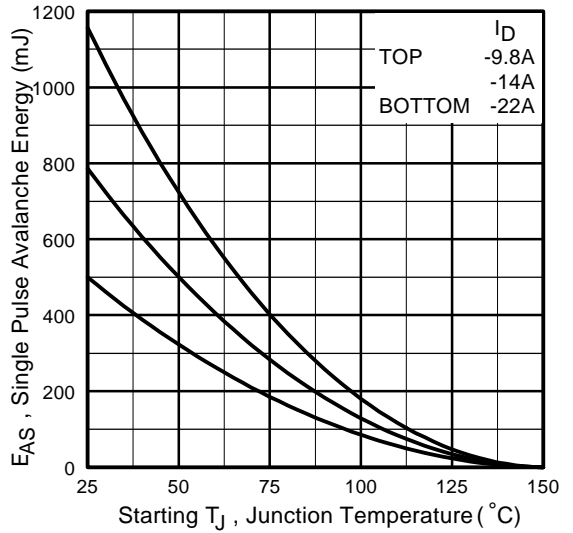

Fig 12c. Maximum Avalanche Energy Vs. Drain Current

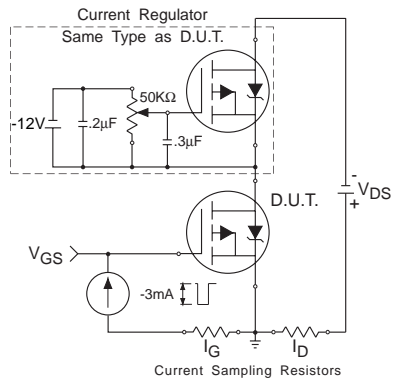
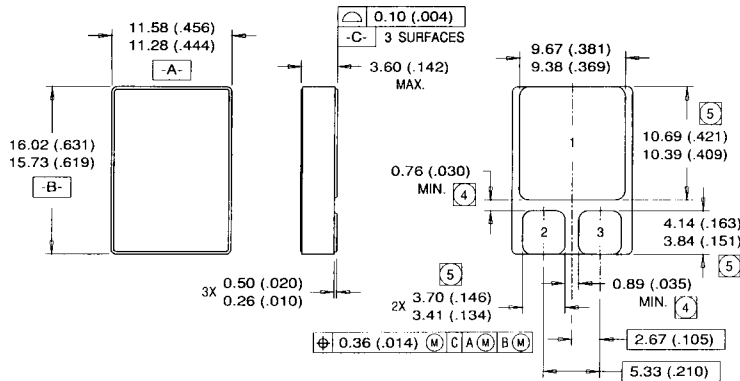

Fig 13b. Gate Charge Test Circuit

- ① Repetitive Rating; Pulse width limited by maximum junction temperature. Refer to current HEXFET reliability report.
- ② @ $V_{DD} = -25V$, Starting $T_J = 25^\circ C$, $EAS = [0.5 * L * (I_L^2)]$
Peak $I_L = -22A$, $V_{GS} = -12V$, $25 \leq R_G \leq 200\Omega$
- ③ $ISD \leq -22A$, $di/dt \leq -450A/\mu s$,
 $V_{DD} \leq BV_{DSS}$, $T_J \leq 150^\circ C$
Suggested $R_G = 2.35\Omega$
- ④ Pulse width $\leq 300 \mu s$; Duty Cycle $\leq 2\%$
irradiation per MIL-STD-750, method 1019, condition A.
- ⑤ **Total Dose Irradiation with V_{GS} Bias.**
12 volt V_{GS} applied and $V_{DS} = 0$ during irradiation per MIL-STD-750, method 1019, condition A.
- ⑥ **Total Dose Irradiation with V_{DS} Bias.**
 $V_{DS} = 0.8$ rated BV_{DSS} (pre-Irradiation) applied and $V_{GS} = 0$ during irradiation per MIL-STD-750, method 1019, condition A.
- ⑦ This test is performed using a flash x-ray source operated in the e-beam mode (energy ~ 2.5 MeV), 30 nsec pulse.
- ⑧ All Pre-Irradiation and Post-Irradiation test conditions are **identical** to facilitate direct comparison for circuit applications.

Case Outline and Dimensions — SMD-1



NOTES:

- 1. DIMENSIONING & TOLERANCING PER ANSI Y14.5M-1982
- 2. CONTROLLING DIMENSION: INCH.
- 3. DIMENSIONS ARE SHOWN IN MILLIMETERS (INCHES).
- ④ DIMENSION INCLUDES METALLIZATION FLASH.
- ⑤ DIMENSION DOES NOT INCLUDE METALLIZATION FLASH.

LEAD ASSIGNMENTS

- 1 = DRAIN
- 2 = GATE
- 3 = SOURCE

SMD-1

International
IOR Rectifier

WORLD HEADQUARTERS: 233 Kansas St., El Segundo, California 90245, Tel: (310) 322 3331

IR GREAT BRITAIN: Hurst Green, Oxted, Surrey RH8 9BB, UK Tel: ++ 44 1883 732020

IR CANADA: 15 Lincoln Court, Brampton, Ontario L6T3Z2, Tel: (905) 453 2200

IR GERMANY: Saalburgstrasse 157, 61350 Bad Homburg Tel: ++ 49 6172 96590

IR ITALY: Via Liguria 49, 10071 Borgaro, Torino Tel: ++ 39 11 451 0111

IR FAR EAST: K&H Bldg., 2F, 30-4 Nishi-Ikebukuro 3-Chome, Toshima-Ku, Tokyo Japan 171 Tel: 81 3 3983 0086

IR SOUTHEAST ASIA: 1 Kim Seng Promenade, Great World City West Tower, 13-11, Singapore 237994 Tel: ++ 65 838 4630

IR TAIWAN: 16 Fl. Suite D. 207, Sec. 2, Tun Haw South Road, Taipei, 10673, Taiwan Tel: 886-2-2377-9936

<http://www.irf.com/> Data and specifications subject to change without notice. 1/99