HD74ALVCH16543

16-bit Registered Transceivers with 3-state Outputs

HITACHI

ADE-205-169A (Z)
2nd. Edition
December 1999

Description

The HD74ALVCH16543 can be used as two 8-bit transceivers or one 16-bit transceiver. Separate latch enable ($\overline{\text{LEAB}}$ or $\overline{\text{LEBA}}$) and output enable ($\overline{\text{OEAB}}$ or $\overline{\text{OEBA}}$) inputs are provided for each register to permit independent control in either direction of data flow. The A to B enable ($\overline{\text{CEAB}}$) input must be low in order to enter data from A or to output data from B. If $\overline{\text{CEAB}}$ is low and $\overline{\text{LEAB}}$ is low, the A to B latches are transparent; a subsequent low to high transition of $\overline{\text{LEAB}}$ puts the A latches in the storage mode. With $\overline{\text{CEAB}}$ and $\overline{\text{OEAB}}$ both low, the 3-state B outputs are active and reflect the data present at the output of the A latches. Data flow from B to A is similar but requires using $\overline{\text{CEBA}}$, $\overline{\text{LEBA}}$, and $\overline{\text{OEBA}}$. Active bus hold circuitry is provided to hold unused or floating data inputs at a valid logic level.

Features

- $V_{CC} = 2.3 \text{ V to } 3.6 \text{ V}$
- Typical V_{OL} ground bounce $< 0.8 \text{ V}$ (@ $V_{CC} = 3.3 \text{ V}$, $T_a = 25^\circ\text{C}$)
- Typical V_{OH} undershoot $> 2.0 \text{ V}$ (@ $V_{CC} = 3.3 \text{ V}$, $T_a = 25^\circ\text{C}$)
- High output current $\pm 24 \text{ mA}$ (@ $V_{CC} = 3.0 \text{ V}$)
- Bus hold on data inputs eliminates the need for external pullup / pulldown resistors

HD74ALVCH16543

Function Table ^{*1}

Inputs				Output B
\overline{CEAB}	\overline{LEAB}	\overline{OEAB}	A	
H	X	X	X	Z
X	X	H	X	Z
L	H	L	X	B ₀ ^{'2}
L	L	L	L	L
L	L	L	H	H

H : High level

L : Low level

X : Immaterial

Z : High impedance

Notes 1. A to B data flow is shown; B to A flow control is the same except that it uses \overline{CEBA} , \overline{LEBA} , and \overline{OEBA} .

2. Output level before the indicated steady state input conditions were established.

Pin Arrangement

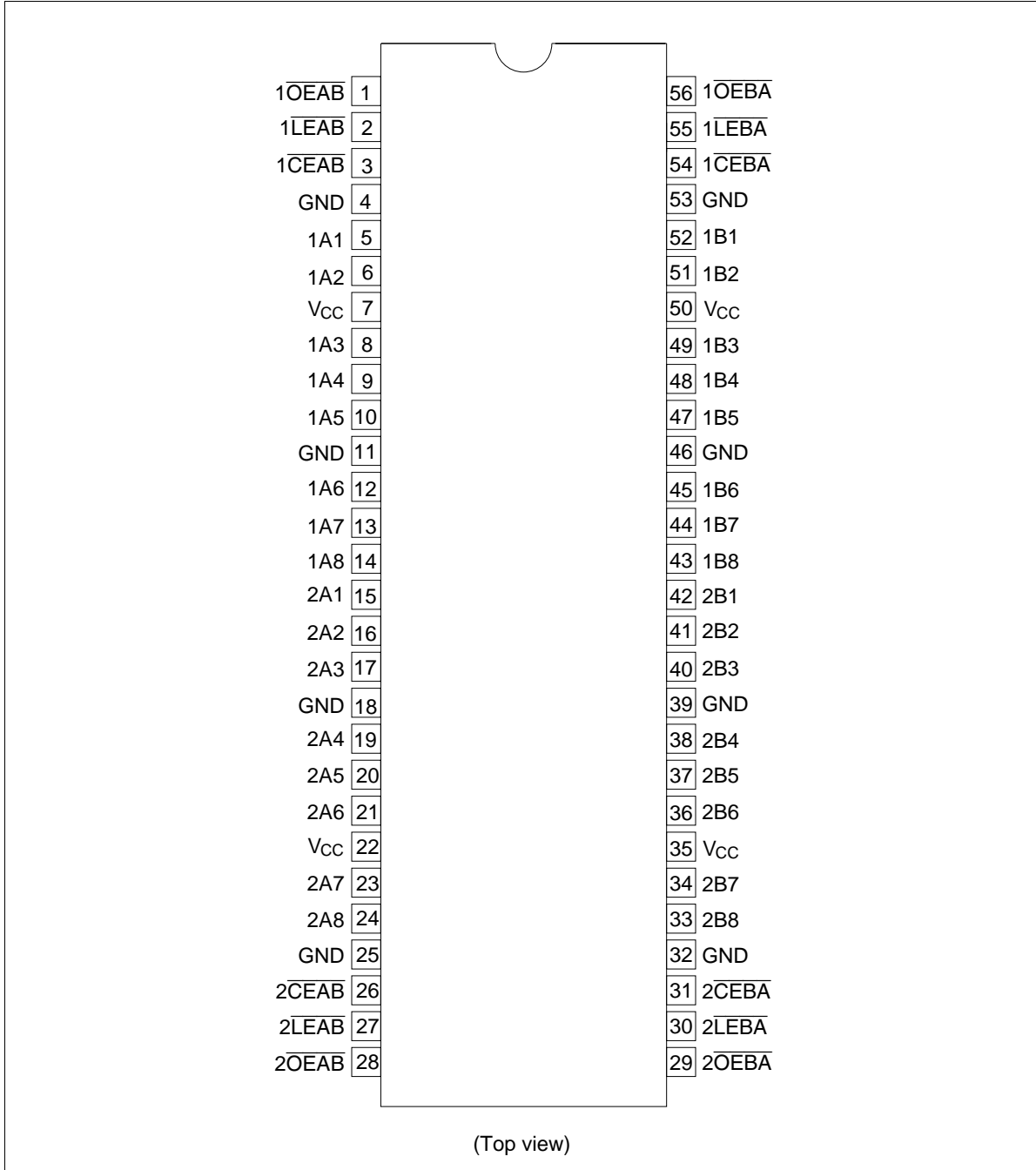

HD74ALVCH16543

Absolute Maximum Ratings

Item	Symbol	Ratings	Unit	Conditions
Supply voltage	V_{CC}	-0.5 to 4.6	V	
Input voltage ^{*1,2}	V_I	-0.5 to 4.6	V	Except I/O ports
		-0.5 to $V_{CC} + 0.5$		I/O ports
Output voltage ^{*1,2}	V_O	-0.5 to $V_{CC} + 0.5$	V	
Input clamp current	I_{IK}	-50	mA	$V_I < 0$
Output clamp current	I_{OK}	± 50	mA	$V_O < 0$ or $V_O > V_{CC}$
Continuous output current	I_O	± 50	mA	$V_O = 0$ to V_{CC}
		± 100		
Maximum power dissipation at $T_a = 55^\circ\text{C}$ (in still air) ^{*3}	P_T	1	W	TSSOP
Storage temperature	T_{stg}	-65 to 150	$^\circ\text{C}$	

Notes: Stresses beyond those listed under "absolute maximum ratings" may cause permanent damage to the device. These are stress ratings only, and functional operation of the device at these or any other conditions beyond those indicated under "recommended operating conditions" is not implied. Exposure to absolute maximum rated conditions for extended periods may affect device reliability.

1. The input and output negative voltage ratings may be exceeded if the input and output clamp current ratings are observed.
2. This value is limited to 4.6 V maximum.
3. The maximum package power dissipation is calculated using a junction temperature of 150°C and a board trace length of 750 mils.

Recommended Operating Conditions

Item	Symbol	Min	Max	Unit	Conditions
Supply voltage	V_{CC}	2.3	3.6	V	
Input voltage	V_I	0	V_{CC}	V	
Output voltage	V_O	0	V_{CC}	V	
High level output current	I_{OH}	—	-12	mA	$V_{CC} = 2.3\text{ V}$
			-12		$V_{CC} = 2.7\text{ V}$
			-24		$V_{CC} = 3.0\text{ V}$
Low level output current	I_{OL}	—	12	mA	$V_{CC} = 2.3\text{ V}$
			12		$V_{CC} = 2.7\text{ V}$
			24		$V_{CC} = 3.0\text{ V}$
Input transition rise or fall rate	$\Delta t / \Delta v$	0	10	ns / V	
Operating temperature	T_a	-40	85	$^\circ\text{C}$	

Note: Unused control inputs must be held high or low to prevent them from floating.

Logic Diagram

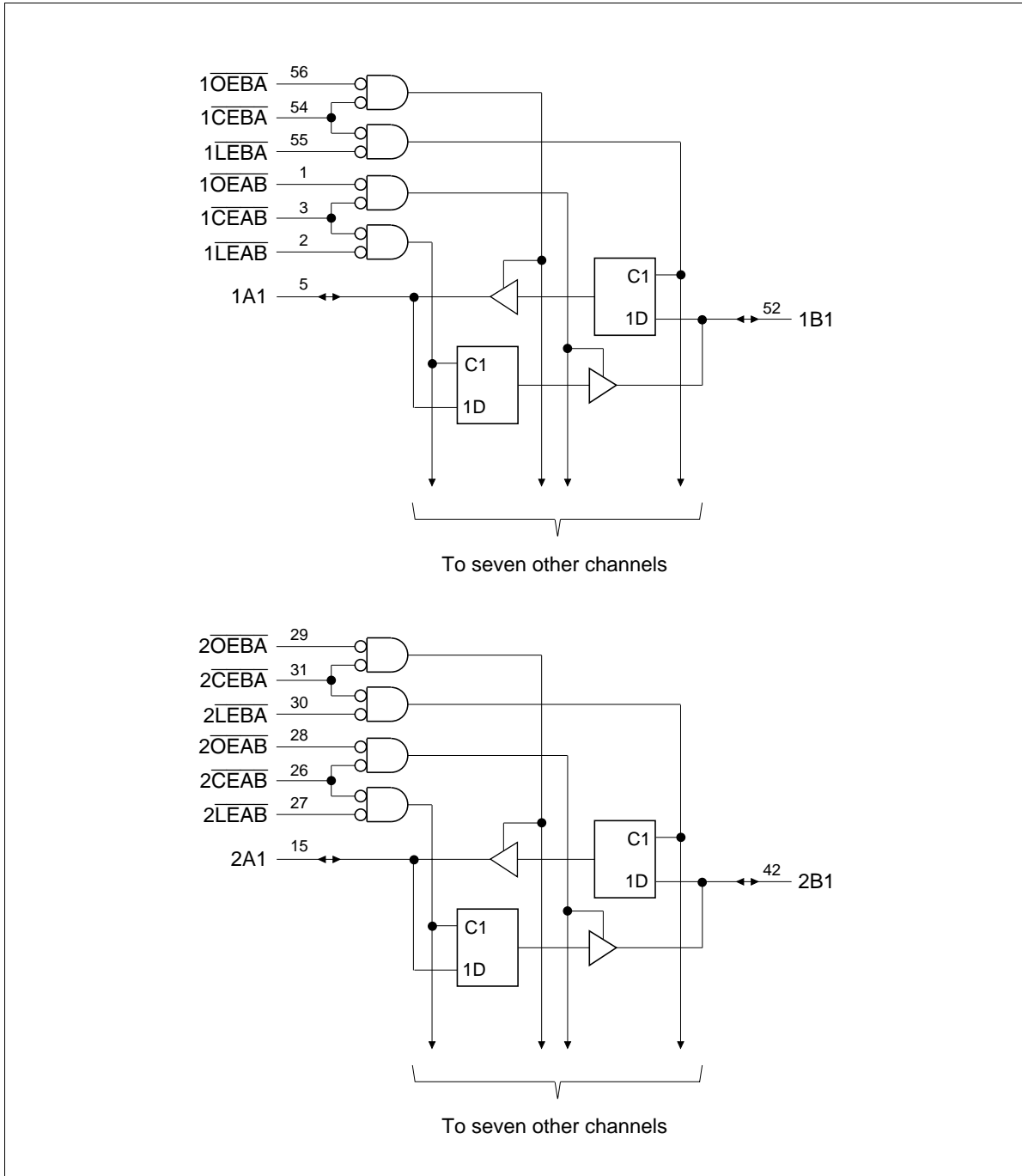

HD74ALVCH16543

Electrical Characteristics (Ta = -40 to 85°C)

Item	Symbol	V _{CC} (V) ¹	Min	Max	Unit	Test Conditions		
Input voltage	V _{IH}	2.3 to 2.7	1.7	—	V			
		2.7 to 3.6	2.0	—				
	V _{IL}	2.3 to 2.7	—	0.7				
		2.7 to 3.6	—	0.8				
Output voltage	V _{OH}	Min to Max	V _{CC} -0.2	—	V	I _{OH} = -100 μA		
		2.3	2.0	—		I _{OH} = -6 mA, V _{IH} = 1.7 V		
		2.3	1.7	—		I _{OH} = -12 mA, V _{IH} = 1.7 V		
		2.7	2.2	—		I _{OH} = -12 mA, V _{IH} = 2.0 V		
		3.0	2.4	—		I _{OH} = -12 mA, V _{IH} = 2.0 V		
		3.0	2.0	—		I _{OH} = -24 mA, V _{IH} = 2.0 V		
	V _{OL}	Min to Max	—	0.2	I _{OL} = 100 μA			
		2.3	—	0.4	I _{OL} = 6 mA, V _{IL} = 0.7 V			
		2.3	—	0.7	I _{OL} = 12 mA, V _{IL} = 0.7 V			
		2.7	—	0.4	I _{OL} = 12 mA, V _{IL} = 0.8 V			
		3.0	—	0.55	I _{OL} = 24 mA, V _{IL} = 0.8 V			
		Input current	I _{IN}	3.6	—	±5	μA	V _{IN} = V _{CC} or GND
				I _{IN (hold)}	2.3	45		—
			I _{IN (hold)}	2.3	-45	—		V _{IN} = 1.7 V
3.0	75			—	V _{IN} = 0.8 V			
I _{IN (hold)}	3.0		-75	—	V _{IN} = 2.0 V			
	3.6		—	±500	V _{IN} = 0 to 3.6 V			
Off state output current ²	I _{OZ}	3.6	—	±10	μA	V _{OUT} = V _{CC} or GND		
Quiescent supply current	I _{CC}	3.6	—	40	μA	V _{IN} = V _{CC} or GND		
	ΔI _{CC}	3.0 to 3.6	—	750	μA	V _{IN} = one input at (V _{CC} -0.6) V, other inputs at V _{CC} or GND		

Notes: 1. For conditions shown as Min or Max, use the appropriate values under recommended operating conditions.

2. For I/O ports, the parameter I_{OZ} includes the input leakage current.

Switching Characteristics (Ta = -40 to 85°C)

Item	Symbol	V _{CC} (V)	Min	Typ	Max	Unit	FROM (Input)	TO (Output)				
Propagation delay time	t _{PLH}	2.5±0.2	1.0	—	5.1	ns	A or B	B or A				
	t _{PHL}	2.7	—	—	4.8							
		3.3±0.3	1.0	—	4.3							
		2.5±0.2	1.1	—	6.5							
			3.3±0.3	1.1	—				5.0			A or B
2.5±0.2						1.0	—	6.8				
Output enable time	t _{ZH}	2.5±0.2	1.0	—	7.2	ns	\overline{CE}	A or B				
	t _{ZL}	2.7	—	—	6.9							
		3.3±0.3	1.0	—	5.6							
		2.5±0.2	1.0	—	6.8							
			3.3±0.3	1.0	—				5.3		\overline{OE}	A or B
2.5±0.2						1.0	—	6.8				
Output disable time	t _{HZ}	2.5±0.2	2.0	—	6.1	ns	\overline{CE}	A or B				
	t _{LZ}	2.7	—	—	6.2							
		3.3±0.3	1.5	—	5.1							
		2.5±0.2	1.6	—	5.7							
			3.3±0.3	1.1	—				4.6		\overline{OE}	A or B
2.5±0.2						1.0	—	6.8				
Input capacitance	C _{IN}	3.3	—	3.5	—	pF	Control inputs					
Output capacitance	C _{IN/O}	3.3	—	7.0	—	pF	A or B ports					

HD74ALVCH16543

Switching Characteristics (Ta = -40 to 85°C) (Cont)

Item	Symbol	V _{cc} (V)	Min	Typ	Max	Unit	FROM (Input)
Setup time	t _{su}	2.5±0.2	1.2	—	—	ns	Data before $\overline{CE}\uparrow$
		2.7	1.5	—	—		
		3.3±0.3	1.2	—	—		
		2.5±0.2	1.2	—	—		Data before $\overline{LE}\uparrow$
		2.7	1.5	—	—		\overline{CE} "L"
		3.3±0.3	1.2	—	—		
Hold time	t _h	2.5±0.2	1.2	—	—	ns	Data after $\overline{CE}\uparrow$
		2.7	0.8	—	—		
		3.3±0.3	1.3	—	—		
		2.5±0.2	1.2	—	—		Data after $\overline{LE}\uparrow$
		2.7	0.8	—	—		\overline{CE} "L"
		3.3±0.3	1.3	—	—		
Pulse width	t _w	2.5±0.2	3.3	—	—	ns	\overline{CE} or \overline{LE} "L"
		2.7	3.3	—	—		
		3.3±0.3	3.3	—	—		

• **Test Circuit**

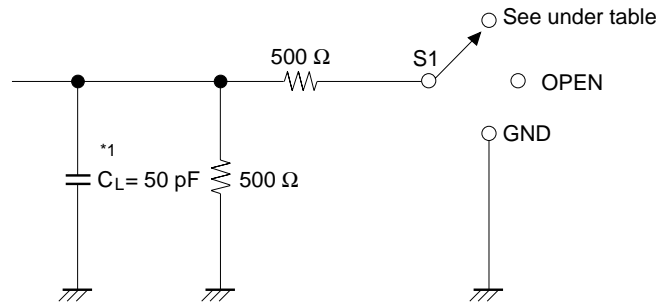

Load Circuit for Outputs

Symbol	$V_{CC}=2.5\pm 0.2V$	$V_{CC}=2.7V,$ $3.3\pm 0.3V$
t_{PLH}/t_{PHL}	OPEN	OPEN
$t_{su}/t_h/t_w$	OPEN	OPEN
t_{ZH}/t_{HZ}	GND	GND
t_{ZL}/t_{LZ}	4.6 V	6.0 V

Note: 1. C_L includes probe and jig capacitance.

HD74ALVCH16543

• Waveforms – 1

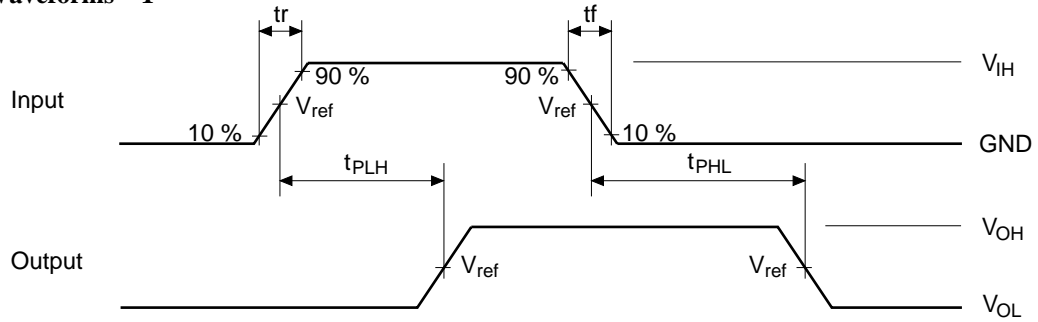

• Waveforms – 2

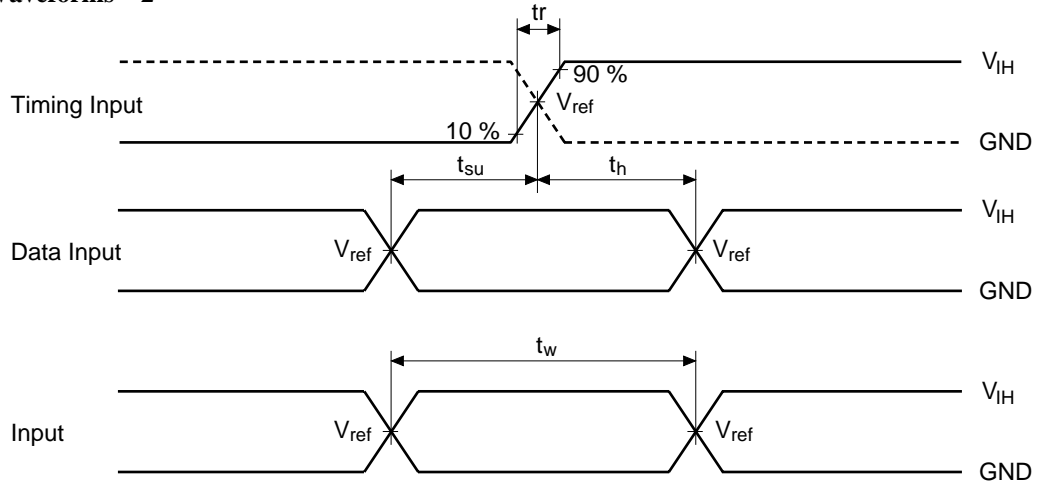

• Waveforms – 3

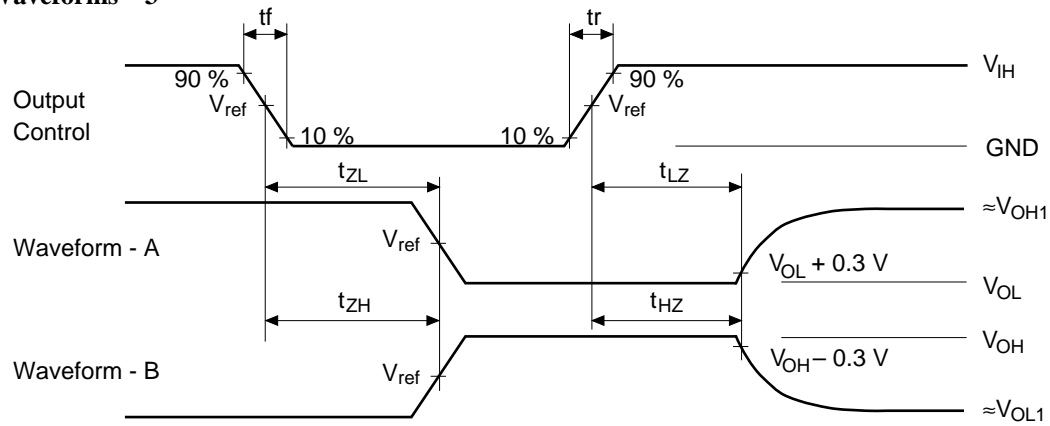

TEST	$V_{CC}=2.5\pm 0.2V$	$V_{CC}=2.7V, 3.3\pm 0.3V$
V_{IH}	2.3 V	2.7 V
V_{ref}	1.2 V	1.5 V
V_{OH1}	2.3 V	3.0 V
V_{OL1}	GND	GND

- Notes:
1. All input pulses are supplied by generators having the following characteristics:
 $PRR \leq 10 \text{ MHz}$, $Z_o = 50 \Omega$, $t_r \leq 2.5 \text{ ns}$, $t_f \leq 2.5 \text{ ns}$.
 2. Waveform – A is for an output with internal conditions such that the output is low except when disabled by the output control.
 3. Waveform – B is for an output with internal conditions such that the output is high except when disabled by the output control.
 4. The output are measured one at a time with one transition per measurement.

HD74ALVCH16543

Package Dimensions

Unit : mm

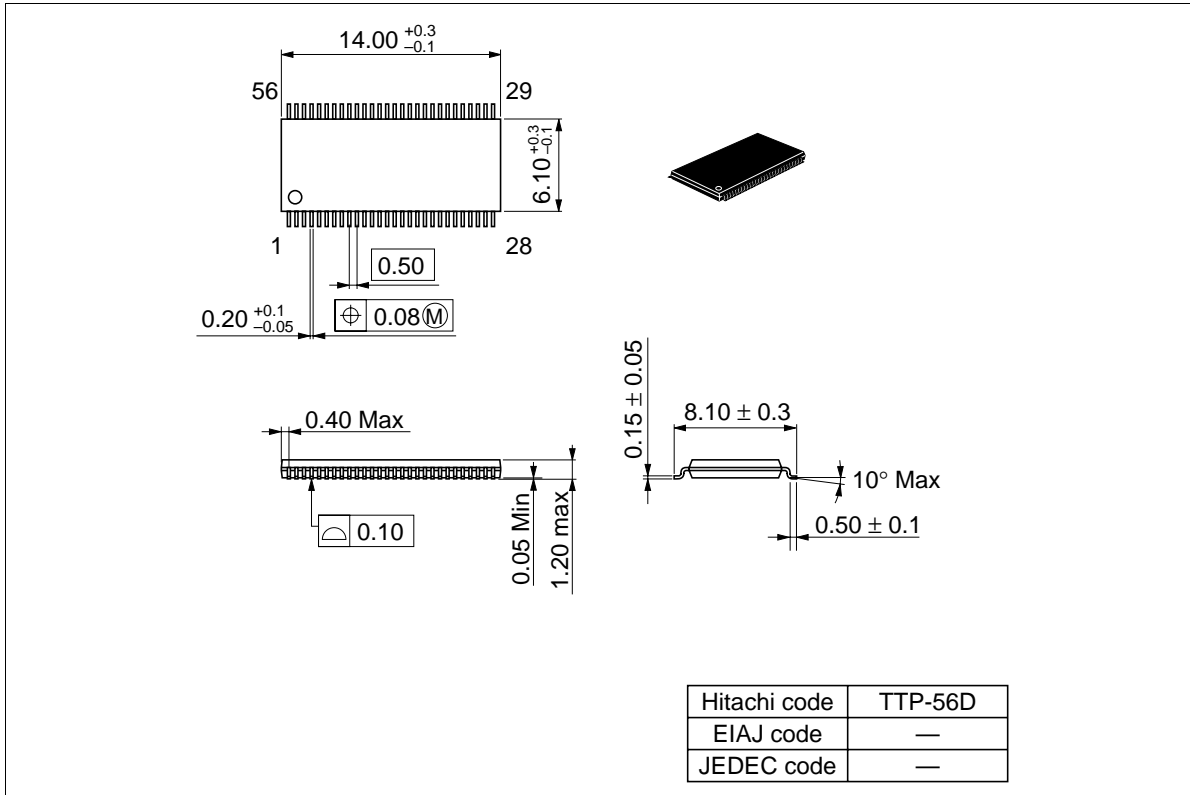

Cautions

1. Hitachi neither warrants nor grants licenses of any rights of Hitachi's or any third party's patent, copyright, trademark, or other intellectual property rights for information contained in this document. Hitachi bears no responsibility for problems that may arise with third party's rights, including intellectual property rights, in connection with use of the information contained in this document.
2. Products and product specifications may be subject to change without notice. Confirm that you have received the latest product standards or specifications before final design, purchase or use.
3. Hitachi makes every attempt to ensure that its products are of high quality and reliability. However, contact Hitachi's sales office before using the product in an application that demands especially high quality and reliability or where its failure or malfunction may directly threaten human life or cause risk of bodily injury, such as aerospace, aeronautics, nuclear power, combustion control, transportation, traffic, safety equipment or medical equipment for life support.
4. Design your application so that the product is used within the ranges guaranteed by Hitachi particularly for maximum rating, operating supply voltage range, heat radiation characteristics, installation conditions and other characteristics. Hitachi bears no responsibility for failure or damage when used beyond the guaranteed ranges. Even within the guaranteed ranges, consider normally foreseeable failure rates or failure modes in semiconductor devices and employ systemic measures such as fail-safes, so that the equipment incorporating Hitachi product does not cause bodily injury, fire or other consequential damage due to operation of the Hitachi product.
5. This product is not designed to be radiation resistant.
6. No one is permitted to reproduce or duplicate, in any form, the whole or part of this document without written approval from Hitachi.
7. Contact Hitachi's sales office for any questions regarding this document or Hitachi semiconductor products.

HITACHI**Hitachi, Ltd.**

Semiconductor & Integrated Circuits.
Nippon Bldg., 2-6-2, Ohte-machi, Chiyoda-ku, Tokyo 100-0004, Japan
Tel: Tokyo (03) 3270-2111 Fax: (03) 3270-5109

URL NorthAmerica : <http://semiconductor.hitachi.com/>
 Europe : <http://www.hitachi-eu.com/hel/ecg>
 Asia (Singapore) : <http://www.has.hitachi.com.sg/grp3/sicd/index.htm>
 Asia (Taiwan) : http://www.hitachi.com.tw/E/Product/SICD_Frame.htm
 Asia (HongKong) : <http://www.hitachi.com.hk/eng/bo/grp3/index.htm>
 Japan : <http://www.hitachi.co.jp/Sicd/index.htm>

For further information write to:

Hitachi Semiconductor
(America) Inc.
179 East Tasman Drive,
San Jose, CA 95134
Tel: <1> (408) 433-1990
Fax: <1> (408) 433-0223

Hitachi Europe GmbH
Electronic components Group
Dornacher StraÙe 3
D-85622 Feldkirchen, Munich
Germany
Tel: <49> (89) 9 9180-0
Fax: <49> (89) 9 29 30 00

Hitachi Europe Ltd.
Electronic Components Group.
Whitebrook Park
Lower Cookham Road
Maidenhead
Berkshire SL6 8YA, United Kingdom
Tel: <44> (1628) 585000
Fax: <44> (1628) 778322

Hitachi Asia Pte. Ltd.
16 Collyer Quay #20-00
Hitachi Tower
Singapore 049318
Tel: 535-2100
Fax: 535-1533

Hitachi Asia Ltd.
Taipei Branch Office
3F, Hung Kuo Building, No.167,
Tun-Hwa North Road, Taipei (105)
Tel: <886> (2) 2718-3666
Fax: <886> (2) 2718-8180

Hitachi Asia (Hong Kong) Ltd.
Group III (Electronic Components)
7/F., North Tower, World Finance Centre,
Harbour City, Canton Road, Tsim Sha Tsui,
Kowloon, Hong Kong
Tel: <852> (2) 735 9218
Fax: <852> (2) 730 0281
Telex: 40815 HITEC HX

Copyright ' Hitachi, Ltd., 1999. All rights reserved. Printed in Japan.