

AZ100LVEL11

PECL/ECL 1:2 Differential Fanout Buffer

www.azmicrotek.com

FEATURES

- 265ps propagation delay
- 5ps skew between outputs
- Internal input pull-down resistors
- Direct replace for ON Semi MC100LVEL11 and MC100EL11

DESCRIPTION

The [AZ100LVEL11](#) is a differential 1:2 fanout gate. The device is functionally similar to the E111 device but with higher performance capabilities. Having within-device skews and output transition times significantly improved over the E111, the AZ100LVEL11 is ideally suited for those applications that require the ultimate in AC performance.

The differential inputs of the AZ100LVEL11 employ clamping circuitry to maintain stability under open input conditions. If the inputs are left open, the Q outputs will go LOW.

The AZ100LVEL11 is a direct replacement for the ON Semi MC100LVEL11 and MC100EL11

BLOCK DIAGRAM

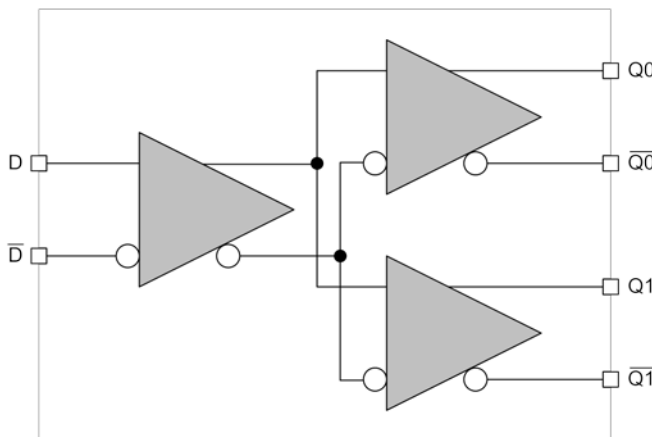

APPLICATIONS

- General applications

PACKAGE AVAILABILITY

- MLP8
- SOIC8
- MSOP8
- Green/RoHS Compliant/Pb-Free

Order Number	Package	Marking
AZ100LVEL11NG ¹	MLP8	L1G ²
AZ100LVEL11D+ ¹	SOIC8	AZM100+LVEL11 ²
AZ100LVEL11TG ¹	MSOP8	AZHGLV11 ²

¹ [Tape & Reel](#) - Add 'R1' at end of order number for 7in (1k parts), 'R2' (2.5k) for 13in

² See www.azmicrotek.com for [date code format](#)

PIN DESCRIPTION AND CONFIGURATION

Table 1 - Pin Description

Pin	Name	Type	Function
1	Q0	Input	Data Input
2	$\overline{Q0}$	Input	Data Input
3	Q1	Input	Data Input
4	$\overline{Q1}$	Output	Data Input
5	V_{EE}	Power	Negative Supply
6	\overline{D}	Output	Data Output
7	D	Output	Data Output
8	V_{CC}	Power	Positive Supply

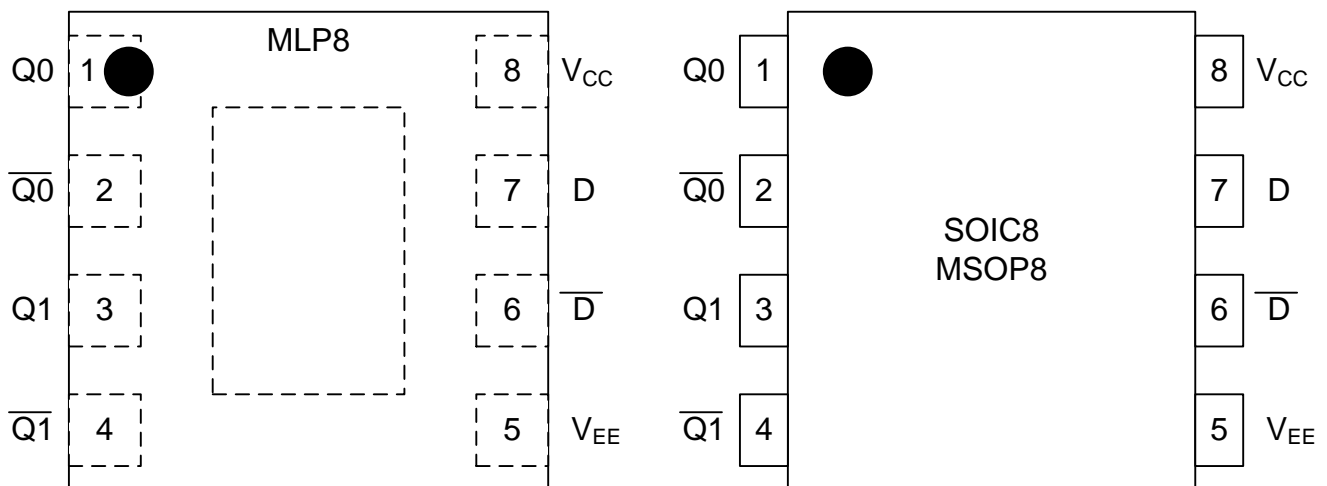

Figure 1 - Pin Configuration for MLP8 & SOIC8/MSOP8

For MLP8, leave center bottom pad open or connect to V_{EE}

ENGINEERING NOTES

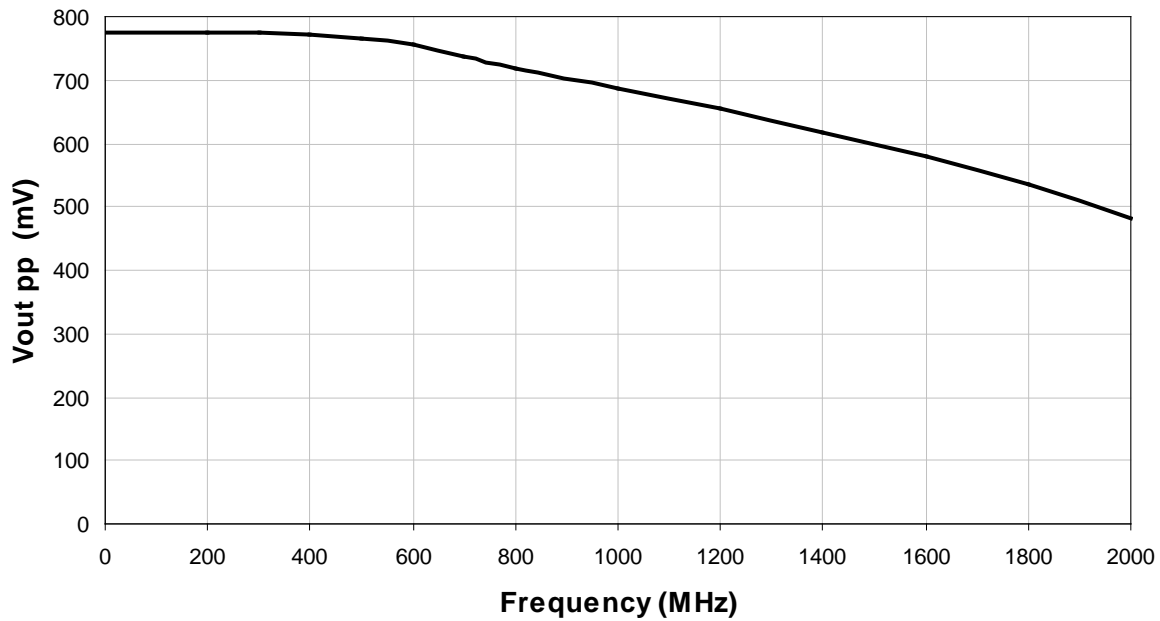

Figure 2 - Typical Output Swing

PERFORMANCE DATA

Table 2 – Absolute Maximum Ratings

Symbol	Characteristic	Condition	Rating	Unit
V_{CC}	PECL Power Supply	$V_{EE} = 0V$	0 to +8.0	V
V_I	PECL Input Voltage	$V_{EE} = 0V$	0 to +6.0	V
V_{EE}	ECL Power Supply	$V_{CC} = 0V$	-8.0 to 0	V
V_I	ECL Input Voltage	$V_{CC} = 0V$	-6.0 to 0	V
I_{OUT}	Output Current	Continuous	50	mA
		Surge	100	
T_A	Operating Temperature Range		-40 to +85	°C
T_{STG}	Storage Temperature Range		-65 to +150	°C
ESD_{HBM}	Human Body Model		2500	V
ESD_{MM}	Machine Model		200	V
ESD_{CDM}	Charged Device Model		2500	V

Table 3 - ECL DC Characteristics

ECL DC Characteristics ($V_{EE} = -3.0V$ to $-5.5V$, $V_{CC} = GND$)

Symbol	Characteristic	-40 °C			0 °C			25 °C			85 °C			Unit
		Min	Typ	Max	Min	Typ	Max	Min	Typ	Max	Min	Typ	Max	
V_{OH}	Output HIGH Voltage ¹	-1085	-1005	-880	-1025	-955	-880	-1025	-955	-880	-1025	-955	-880	mV
V_{OL}	Output LOW Voltage ¹	-1830	-1695	-1555	-1810	-1705	-1620	-1810	-1705	-1620	-1810	-1705	-1620	mV
V_{IH}	Input HIGH Voltage	-1165		-880	-1165		-880	-1165		-880	-1165		-880	mV
V_{IL}	Input LOW Voltage	-1810		-1475	-1810		-1475	-1810		-1475	-1810		-1475	mV
I_{IL}	Input LOW Current	-150			-150			-150			-150			μA
I_{IH}	Input HIGH Current			150			150			150			150	μA
I_{EE}	Power Supply Current		22	31		23	31		24	31		28	34	mA

¹ Each output is terminated through a 50 Ω resistor to $V_{CC} -2V$

Table 4 - LVPECL DC Characteristics

LVPECL DC Characteristics ($V_{EE} = GND$, $V_{CC} = +3.3V$)

Symbol	Characteristic	-40 °C			0 °C			25 °C			85 °C			Unit
		Min	Typ	Max	Min	Typ	Max	Min	Typ	Max	Min	Typ	Max	
V_{OH}	Output HIGH Voltage ¹	2215	2295	2420	2275	2345	2420	2275	2345	2420	2275	2345	2420	mV
V_{OL}	Output LOW Voltage ¹	1470	1605	1745	1490	1595	1680	1490	1595	1680	1490	1595	1680	mV
V_{IH}	Input HIGH Voltage	2135		2420	2135		2420	2135		2420	2135		2420	mV
V_{IL}	Input LOW Voltage	1490		1825	1490		1825	1490		1825	1490		1825	mV
I_{IL}	Input LOW Current	-150			-150			-150			-150			μA
I_{IH}	Input HIGH Current			150			150			150			150	μA
I_{EE}	Power Supply Current		22	31		23	31		24	31		28	34	mA

¹ Each output is terminated through a 50 Ω resistor to $V_{CC} -2V$

Table 5 - PECL DC Characteristics

PECL DC Characteristics ($V_{EE} = GND$, $V_{CC} = +5.0V$)

Symbol	Characteristic	-40 °C			0 °C			25 °C			85 °C			Unit
		Min	Typ	Max	Min	Typ	Max	Min	Typ	Max	Min	Typ	Max	
V_{OH}	Output HIGH Voltage ¹	3915	3995	4120	3975	4045	4120	3975	4045	4120	3975	4045	4120	mV
V_{OL}	Output LOW Voltage ¹	3170	3305	3445	3190	3295	3380	3190	3295	3380	3190	3295	3380	mV
V_{IH}	Input HIGH Voltage	3835		4120	3835		4120	3835		4120	3835		4120	mV
V_{IL}	Input LOW Voltage	3190		3525	3190		3525	3190		3525	3190		3525	mV
I_{IL}	Input LOW Current	-150			-150			-150			-150			μA
I_{IH}	Input HIGH Current			150			150			150			150	μA
I_{EE}	Power Supply Current		22	31		23	31		24	31		28	34	mA

¹ Each output is terminated through a 50 Ω resistor to $V_{CC} -2V$

Table 6 - AC Characteristics

AC Characteristics ($V_{EE} = -3.0V$ to $-5.5V$, $V_{CC} = GND$ or $V_{EE} = GND$, $V_{CC} = +3.0V$ to $+5.0V$)

Symbol	Characteristic	-40 °C			0 °C			25 °C			85 °C			Unit
		Min	Typ	Max	Min	Typ	Max	Min	Typ	Max	Min	Typ	Max	
t_{PLH}/t_{PHL}	Propagation Delay to Output	135	260	335	185	260	335	190	265	340	215	310	365	ps
t_{skew}	Duty Cycle Skew ¹		5			5	20		5	20		5	20	ps
	Within Device Skew ²		5			5	20		5	20		5	20	ps
V_{PP}	Minimum Input Swing ³	150			150			150			150			mV
V_{CMR}	Common Mode Range ⁴	$V_{EE} + 1.2$		$V_{CC} - 0.2$	$V_{EE} + 1.2$		$V_{CC} - 0.2$	$V_{EE} + 1.2$		$V_{CC} - 0.2$	$V_{EE} + 1.2$		$V_{CC} - 0.2$	V
t_r/t_f	Output Rise/Fall Times Q (20%-80%)	100		260	100		260	100		260	100		260	ps

¹ Within-device skew defined as identical transitions on similar paths through a device.

² Duty cycle skew is the difference between a t_{PLH} and t_{PHL} propagation delay through a device.

³ V_{PP} is the minimum peak-to-peak differential input swing for which AC parameters guaranteed. The device has a DC gain of 40.

⁴ The V_{CMR} range is referenced to the most positive side of the differential input signal. Normal operation is obtained if the HIGH level falls within the specified range and the peak-to-peak voltage lies between V_{PP} (min) and 1V.

PACKAGE DIAGRAM

MLP8
Green/RoHS compliant/Pb-Free
MSL=1

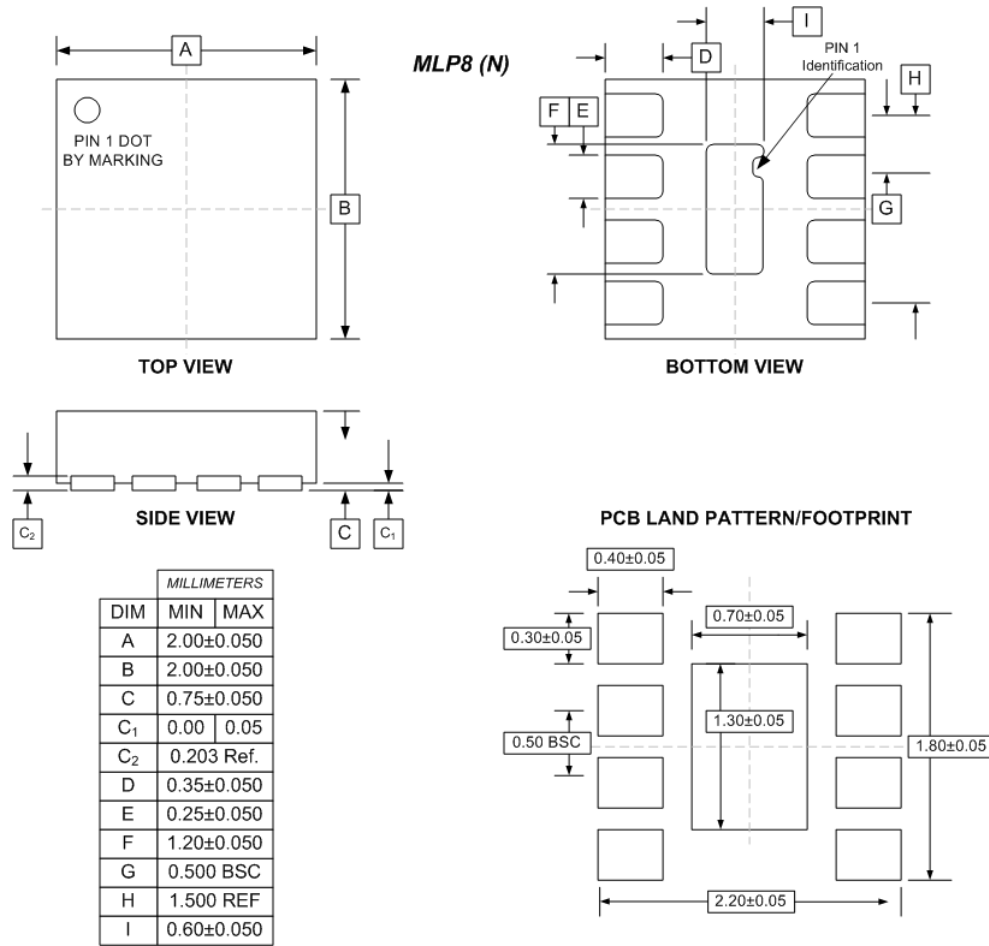

PACKAGE DIAGRAM
SOIC8
 Green/RoHS compliant/Pb-Free
 MSL=1

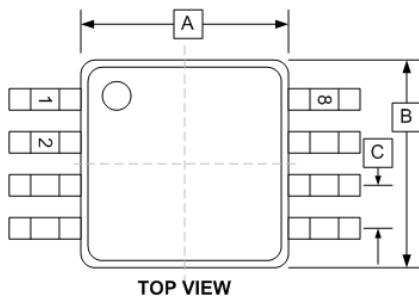

SOIC8 (D)

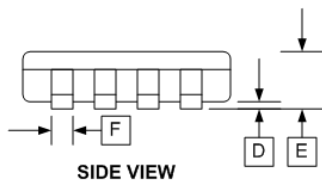
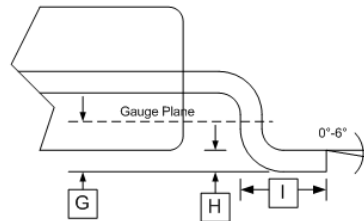

PCB LAND PATTERN/FOOTPRINT

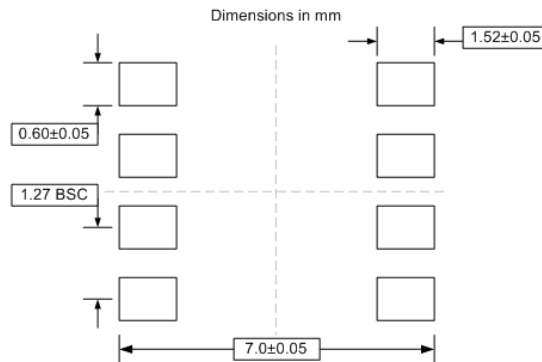

DIM	INCHES	
	MIN	MAX
A	0.189	0.196
B	0.150	0.157
C	0.050 BSC	
D	0.004	0.01
E	0.054	0.068
F	0.014	0.019
G	0.010	
H	0.0075	0.0098
I	0.016	0.034

PACKAGE DIAGRAM
MSOP8
 Green/RoHS compliant/Pb-Free
 MSL=1

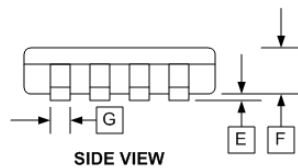
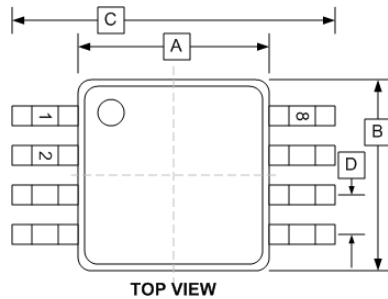

DIM	INCHES	
	MIN	MAX
A	0.118±0.004	
B	0.118±0.004	
C	0.192±0.008	
D	0.0256 TYP	
E	0.004±0.002	
F	0.034±0.002	
G	0.009±0.014	
H	0.010	
I	0.006±0.002	
J	0.021±0.004	

MSOP8 (T)

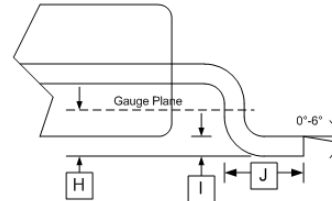

PCB LAND PATTERN/FOOTPRINT

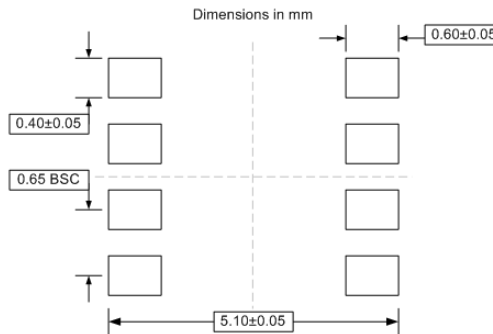

Arizona Microtek, Inc. reserves the right to change circuitry and specifications at any time without prior notice. Arizona Microtek, Inc. makes no warranty, representation or guarantee regarding the suitability of its products for any particular purpose, nor does Arizona Microtek, Inc. assume any liability arising out of the application or use of any product or circuit and specifically disclaims any and all liability, including without limitation special, consequential or incidental damages. Arizona Microtek, Inc. does not convey any license rights nor the rights of others. Arizona Microtek, Inc. products are not designed, intended or authorized for use as components in systems intended to support or sustain life, or for any other application in which the failure of the Arizona Microtek, Inc. product could create a situation where personal injury or death may occur. Should Buyer purchase or use Arizona Microtek, Inc. products for any such unintended or unauthorized application, Buyer shall indemnify and hold Arizona Microtek, Inc. and its officers, employees, subsidiaries, affiliates, and distributors harmless against all claims, costs, damages, and expenses, and reasonable attorney fees arising out of, directly or indirectly, any claim of personal injury or death associated with such unintended or unauthorized use, even if such claim alleges that Arizona Microtek, Inc. was negligent regarding the design or manufacture of the part.