

**ebm-papst St. Georgen GmbH & Co. KG**

Hermann-Papst-Straße 1

D-78112 St. Georgen

Phone +49 7724 81-0

Fax +49 7724 81-1309

info2@de.ebmpapst.com

www.ebmpapst.com

Nominal data

Type	3900	
Phase		1~
Nominal voltage	VAC	115
Frequency	Hz	60
Speed	min ⁻¹	3150
Power input	W	9.0
Min. ambient temperature	°C	-20
Max. ambient temperature	°C	80
Air flow	m ³ /h	70
Sound power level	B	5.1
Sound pressure level	dB(A)	40

ml = max. load · me = max. efficiency · fa = running at free air · cs = customer specs · cu = customer unit
Subject to alterations



Technical features

General description	<p>AC voltage fan with internal rotor shaded-pole motor. Protected from overload by impedance protection.</p> <p>Fan housing made of metal, impeller made of mineral-reinforced PA plastic.</p> <p>Air exhaust over bars. Rotational direction counter-clockwise looking at rotor.</p> <p>Electrical connection to 2 flat plugs 2.8 x 0.5 mm.</p> <p>Fan housing with grounding lug for M4 screw.</p> <p>Mass 280 g.</p> <p>Please note our new ACmaxx series. With identical fastening dimensions and voltages, this series achieves higher energy efficiency.</p>
Mass	0.280 kg
Dimensions	92 x 92 x 25 mm
Material of impeller	Mineral-reinforced PA plastic
Housing material	Metal
Direction of air flow	Air exhaust over bars
Direction of rotation	Left, looking at rotor
Bearing	Sintec sleeve bearing system
Lifetime L10 at 40 °C	60000 h
Lifetime L10 at maximum temperature	22500 h
Connection line	2 flat plugs 2.8 x 0.5 mm. Housing with grounding lug for M4 screw.
Motor protection	Protected from overload using impedance protection
Approval	VDE, CSA, UL, CE

Product drawing

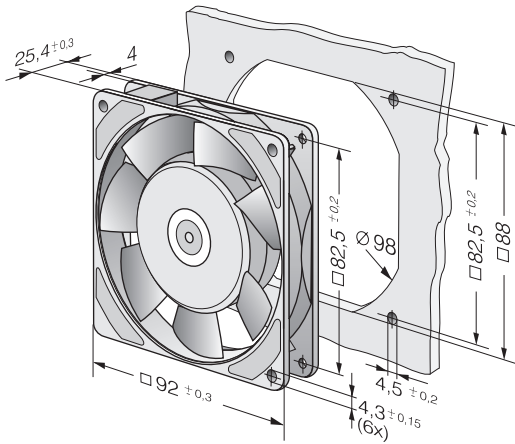

Charts: Air flow

