

REV	DESCRIPTION	DATE	PREP	APPD
B	05-0448	3/1/05	KS	KS

APPROVALS		DATE			VECTRON INTERNATIONAL MOUNT HOLLY SPRINGS, PA 17065	
PREPARED BY	K. Sheriff	3/3/03	OSCILLATOR SPECIFICATION Hi-Rel Standard OCXO			
PROCESS	D. Risser	6/23/04				
QUALITY	R.L. Smith	6/30/04				
ENGINEER	K. Sheriff	5/7/04				
			CODE IDENT NO	SIZE	DWG. NO.	REV
			00136	A	OS-80001	B
			UNSPECIFIED TOLERANCES: N/A			SHEET 1 OF 15

1. SCOPE

1.1 General. This specification defines the design, assembly and functional evaluation of high reliability Oven-Controlled Crystal Oscillators (OCXO) produced by Vectron International. Devices delivered to this specification are processed with standard documents, procedures, and processes developed by Vectron International. Ordering information, including an order entry sheet, is detailed to facilitate part number definition and ordering.

1.2 Classification. All devices defined by this specification are Type 4 or Type 6 oscillators In Accordance With (IAW) MIL-PRF-55310.

1.2.1 Part Number Breakdown.

<u>C499</u>	<u>1</u>	<u>R</u>	<u>A</u>	<u>-0001</u>	<u>S</u>
Base Model #	Oscillator Class (See 1.2.2)	Radiation Environment (See 1.2.3)	Temperature Range (See 1.2.4)	Dash Number (See 1.2.5)	Screening Option (See 1.2.6)

1.2.2 Oscillator Class. The oscillator classes covered by this specification are identified buy technology class as follows:

Class 1 --- Oscillators using discrete technology. This technology uses exclusively discrete type electronic parts (including surface mount devices) assembled and interconnected on a printed circuit board or an insulating substrate.

Class 2 --- Oscillators using microelectronic (hybrid) technology. This technology uses microelectronic circuit elements electrically and mechanically interconnected on an insulating substrate upon which resistors, capacitors, or conductors have been deposited, and used in a package that will be backfilled with an inert gas.

Class 3 --- Oscillators using mixed technology (i.e., a combination of discrete technology and microelectronic technology).

1.2.3 Radiation Environment. The radiation environment is identified by a single letter as follows:

R --- Radiation Environment, Swept High Q Synthetic Quartz

X --- Non-Radiation Environment, High Q Synthetic Quartz

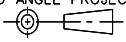
SIZE A	CODE IDENT NO. 00136	THIRD ANGLE PROJECTION 	UNSPECIFIED TOLERANCES N/A	DWG NO. OS-80001	REV. B	SHEET 2
------------------	--------------------------------	---	--------------------------------------	----------------------------	------------------	-------------------

1.2.4 Temperature Range. The operating temperature range is identified by a single letter as follows:

- A --- Other, Customer Specified
- B --- 0°C to +50°C
- C --- 0°C to +70°C
- D --- -20°C to +70°C
- E --- -40°C to +70°C
- F --- -40°C to +85°C
- L --- -55°C to +85°C

1.2.5 Dash Number. The dash number uniquely identifies the OCXO. The dash number will be assigned by Vectron International after order placement, or prior to order placement if the customer requires the dash number to be placed on the official purchase order.

1.2.6 Screening Option. The screening option is identified by a single letter as follows. See Table 1 and 2 for detailed screening information.

- A --- Customer Specified
- S --- Product Level S, MIL-PRF-55310 (High reliability space applications).
For Class 2 and 3 oscillators, microelectronics will be screened IAW MIL-PRF-38534, Class K.
- B --- Product Level B, MIL-PRF-55310 (High reliability applications).
For Class 2 and 3 oscillators, microelectronics will be screened IAW MIL-PRF-38534, Class H.
- R --- Modified MIL-PRF-55310, Product Level B.
For Class 1 oscillators, plastic encapsulated surface mount devices screened IAW with MIL-PRF-19500 for JANTX parts may be used.
For Class 2 and 3 oscillators, microelectronics will not be screened.
- E --- Engineering Model (EM) (See Note 1)
- P --- Proof of Design (POD) / Prototype (See Note 1)

Note 1: When option E or P is selected, unscreened or commercial grade components may be used in the product.

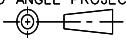
SIZE A	CODE IDENT NO. 00136	THIRD ANGLE PROJECTION 	UNSPECIFIED TOLERANCES N/A	DWG NO. OS-80001	REV. B	SHEET 3
------------------	--------------------------------	---	--------------------------------------	----------------------------	------------------	-------------------

2. APPLICABLE DOCUMENTS

- 2.1 Specifications and Standards. The following specifications and standards form a part of this document to the extent specified herein. The issue currently in effect on the date of quotation will be the product baseline, unless otherwise specified.

SPECIFICATION

MIL-PRF-55310 --- Oscillator, Crystal Controlled, General Specification for
MIL-PRF-38534 --- Hybrid Microcircuits, General Specification for

STANDARDS

MIL-STD-202 --- Test Methods for Electronic and Electrical Component Parts
MIL-STD-794 --- Parts and Equipment, Procedures for Packaging of
MIL-STD-883 --- Test Method Standard Microcircuits

VECTRON INTERNATIONAL

QSP-90100 --- Quality Systems Manual
QSP-90401 --- Reliability Assurance Procedure for New Products
QSP-90800 --- Product Identification and Traceability Procedure
QSP-91502 --- Electrostatic Discharge Precautions Procedure
GR-53731 --- Work Instructions for Packaging and Shipping

OTHER

IPC-A-610 --- Acceptability of Electronic Assemblies

- 2.2 Order of Precedence. In the event of a conflict between the text of this document and the references cited herein, the text of this document takes precedence.

3. GENERAL REQUIREMENTS

- 3.1 Design and Construction. The ruggedized designs implemented for these devices are proven in military and space applications under extreme environments. Typical designs utilize 4-point crystal mounting and established reliability components. When specified, radiation hardening up to 100krad(Si) can be included without altering the device's internal topography.
- 3.2 Assembly and Workmanship. All devices delivered to this specification are assembled IAW MIL-PRF-55310 and IPC-A-610, class 3.
- 3.3 Electrical. Unless specified otherwise, all devices delivered to this specification are tested IAW MIL-PRF-55310.

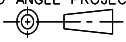
SIZE	CODE IDENT NO.	THIRD ANGLE PROJECTION	UNSPECIFIED TOLERANCES	DWG NO.	REV.	SHEET
A	00136		N/A	OS-80001	B	4

- 3.4 Inspection. The inspection requirements of MIL-PRF-55310 apply to all devices delivered to this document. Inspection conditions and standards are documented in accordance with the Quality Assurance System as defined in QSP-90100 (ISO-9001 derived).
- 3.5 Traceability. Active device lots are homogenous and traceable to the manufacturer's individual wafer. Crystals are traceable to the quartz bar and the processing details of the autoclave lot, as applicable. All other elements and materials are traceable to their incoming inspection lots.
- 3.6 Marking. Device marking shall be in accordance with the requirements of MIL-PRF-55310.
- 3.7 Packaging. All devices delivered are packaged in such a manner that they will be protected from damage during shipping, handling, and storage. Devices are packaged in anti-static packaging and identified as being static sensitive in accordance with QSP-91502.

4. DETAIL REQUIREMENTS

4.1 Components.

- 4.1.1 Crystals. Design and construction of crystal units are in accordance with MIL-C-3098 and the applicable detailed crystal specification drawing for the device being delivered. Crystal units utilize a 4 point mount structure. When radiation environment R is specified (see paragraph 1.2.3) premium Q swept cultured quartz will be used.
- 4.1.2 Discrete Passive Components. Discrete passive components are either high reliability military parts or established reliability (ER) military parts with a failure rate level R or better. Ceramic capacitors are procured per MIL-C-123 or are subjected to destructive physical analysis (DPA) and humidity, steady state and low voltage testing IAW MIL-C-123.
- 4.1.3 Packaged Semiconductors. Packaged semiconductors are of the type JAN, JANTX, or JANTXV IAW MIL-PRF-19500. Class 1 oscillators, screening option R, may use plastic encapsulated surface mount devices screened IAW with MIL-PRF-19500 for JAN or JANTX.
- 4.1.4 Microcircuits. Microcircuits are procured from wafer lots that have passed MIL-PRF-55310 Lot Acceptance Tests for Class S devices.
- 4.1.5 Hybrid Elements. The dies used in hybrid circuitry are procured from wafer lots that have passed MIL-PRF-55310 Lot Acceptance Tests for Class S devices. Multilayer, ceramic chip capacitors are subjected to DPA, and humidity, steady state and low voltage testing in accordance with MIL-C-123.
- 4.2 Materials. The materials, packages, terminals, and finishes used in the construction of devices, procured per this specification, shall meet the requirements of MIL-PRF-55310.

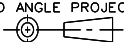
SIZE A	CODE IDENT NO. 00136	THIRD ANGLE PROJECTION 	UNSPECIFIED TOLERANCES N/A	DWG NO. OS-80001	REV. B	SHEET 5
------------------	--------------------------------	---	--------------------------------------	----------------------------	------------------	-------------------

5. QUALITY ASSURANCE PROVISIONS AND VERIFICATION

5.1 Verification and Test. Device lots are tested prior to delivery in accordance with the applicable Screening Option letter as stated on the customer's purchase order. Table 1 tests are conducted in the order shown and annotated on the appropriate process travelers and data sheets of the governing test procedure.

5.2 Test Conditions. Unless otherwise stated herein, inspections are performed in accordance with those specified in MIL-PRF-55310 and MIL-PRF-38534, in that order. Process travelers identify the applicable methods, conditions and procedures to be used.

5.3 Deliverables. The manufacturer supplies the following data, as a minimum, with each lot of devices:

- ◆ Completed assembly and screening lot travelers, including rework history.
- ◆ Electrical test variables data, identified by unique serial number.
- ◆ Data as required by purchase order.

5.4 Conformance Inspection. When specified on the purchase order, Group A and B conformance inspection will be performed IAW MIL-PRF-55310.

5.5 Group C Inspection. When specified on the purchase order, Group C inspection will be performed IAW MIL-PRF-55310.

6. ORDERING INFORMATION

6.1 Part Number. Define Part Number as detailed in paragraph 1.2 of this document.

6.2 Detailed Requirements. Complete the Order Entry Sheet, attached to the end of this document, for specific information concerning the oscillator requirements. If the requirement is Not Applicable place an NA in the appropriate field. It is very important not to over specify a requirement. We at Vectron International fully understand that the customer may not have the ability to determine all of the requirements noted on the order entry sheet. If at any time a question arises, please contact your sales representative and/or our Hi-Rel/Military Engineering group to assist you.

6.3 Environmental Conditions. Specify the detailed environmental conditions for the oscillator on the Order Entry Sheet attached to the end of this document. If the requirement is Not Applicable place an NA in the appropriate field.

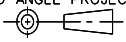
SIZE A	CODE IDENT NO. 00136	THIRD ANGLE PROJECTION 	UNSPECIFIED TOLERANCES N/A	DWG NO. OS-80001	REV. B	SHEET 6
------------------	--------------------------------	---	--------------------------------------	----------------------------	------------------	-------------------

6.4 Oscillator Package. Depending on package chosen, some electrical parameters or screening options may not be available.

Type A – Other, Customer Defined

Type B – Class 1 Oscillators (See Figure 1)

Type C – Class 2 Oscillators (See Figure 2)

Type D – Class 3 Oscillators (See Figure 3)

6.5 Additional Ordering information. The following is a list of options that can be added by purchase order request.

Group A Inspection IAW MIL-PRF-55310

Group B Inspection IAW MIL-PRF-55310

Group C Inspection IAW MIL-PRF-55310

Internal Water-Vapor Content (RGA) samples and test performance

Destruct Physical Analysis (DPA) Test Specimens

Reliability Predictions (MTBF)

Manufacturer's Parts List

Deliverable Process Identification Documentation (PID)

Program Management

Customer Source Inspection (pre-cap / final)

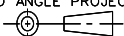
SIZE A	CODE IDENT NO. 00136	THIRD ANGLE PROJECTION 	UNSPECIFIED TOLERANCES N/A	DWG NO. OS-80001	REV. B	SHEET 7
------------------	--------------------------------	---	--------------------------------------	----------------------------	------------------	-------------------

Screening Requirements (100%) for Class 1 and 3 Oscillators:

Process ID	OPERATION LISTING	Option S (MIL-PRF-55310 Product Level S)	Option B (MIL-PRF-55310 Product Level B)	Option R (Modified MIL-PRF-55310 Product Level B)	Option E (Eng. Model)	Option P (POD/Prototype)
1	Random Vibration	MIL-STD-202, Meth 214, Cond I-B, duration 5 minutes per axis	N/A	N/A	N/A	N/A
2	Thermal Shock	MIL-STD-202, Meth 107, Test Condition Letter A-1	MIL-STD-202, Meth 107 Test Condition Letter A	MIL-STD-202, Meth 107 Test Condition Letter A	N/A	N/A
3	Electrical Test (Pre Burn-in) Input current-power Output waveform Output voltage-power As specified	MIL-PRF-55310, Par. 4.8.5 MIL-PRF-55310, Par. 4.8.20 MIL-PRF-55310, Par. 4.8.21 Customer PO	N/A N/A N/A Customer PO	N/A N/A N/A Customer PO	N/A N/A N/A Customer PO	N/A N/A N/A Customer PO
4	Burn-in (load)	Maximum specified operating temperature, nominal supply voltage and burn-in load, 240 hours minimum	Maximum specified operating temperature, nominal supply voltage and burn-in load, 160 hours minimum	Maximum specified operating temperature, nominal supply voltage and burn-in load, 160 hours minimum	Room temperature, nominal supply voltage and load, 160 hours minimum	N/A
5	Electrical Test (Post Burn-in) Input current-power Output waveform Output voltage-power As specified	MIL-PRF-55310, Par. 4.8.5 MIL-PRF-55310, Par. 4.8.20 MIL-PRF-55310, Par. 4.8.21 Customer PO	MIL-PRF-55310, Par. 4.8.5 MIL-PRF-55310, Par. 4.8.20 MIL-PRF-55310, Par. 4.8.21 Customer PO	MIL-PRF-55310, Par. 4.8.5 MIL-PRF-55310, Par. 4.8.20 MIL-PRF-55310, Par. 4.8.21 Customer PO	Room Temperature Only MIL-PRF-55310, Par. 4.8.5 MIL-PRF-55310, Par. 4.8.20 MIL-PRF-55310, Par. 4.8.21 Customer PO	Room Temperature Only MIL-PRF-55310, Par. 4.8.5 MIL-PRF-55310, Par. 4.8.20 MIL-PRF-55310, Par. 4.8.21 Customer PO
6	Seal Test (If Applicable)	MIL-STD-202, Meth 112, Test Condition Letter D	MIL-STD-202, Meth 112, Test Condition Letter D	MIL-STD-202, Meth 112, Test Condition Letter D	MIL-STD-202, Meth 112, Test Condition Letter D	MIL-STD-202, Meth 112, Test Condition Letter D
7	Radiographic	MIL-STD-202, Meth 209, Test Condition Letter B	N/A	N/A	N/A	N/A

TABLE 1 - Class 1 and 3 Test Matrix

SIZE A	CODE IDENT NO. 00136	THIRD ANGLE PROJECTION 	UNSPECIFIED TOLERANCES N/A	DWG NO. OS-80001	REV. B	SHEET 8
------------------	--------------------------------	---	--------------------------------------	----------------------------	------------------	-------------------

Screening Requirements (100%) for Class 2 Oscillators:

Process ID	OPERATION LISTING	Option S (MIL-PRF-55310 Product Level S)	Option B (MIL-PRF-55310 Product Level B)	Option R (Modified MIL-PRF-55310 Product Level B)	Option E (Eng. Model)	Option P (POD/Prototype)
1	Non-Destruct Bond Pull	MIL-STD-883, Meth 2023	N/A	N/A	N/A	N/A
2	Internal Visual	MIL-STD-883, Meth 2017 Cond H, Meth 2032 Cond M	MIL-STD-883, Meth 2017 Cond H, Meth 2032 Cond M	MIL-STD-883, Meth 2017 Cond H, Meth 2032 Cond M	MIL-STD-883, Meth 2017 Cond H, Meth 2032 Cond M	N/A
3	Stabilization Bake (prior to seal)	MIL-STD-883, Meth 1008, Cond C, 150°C, 48 hours min.	MIL-STD-883, Meth 1008, Cond C, 150°C, 24 hours min.	MIL-STD-883, Meth 1008, Cond C, 150°C, 24 hours min.	MIL-STD-883, Meth 1008, Cond C, 150°C, 24 hours min.	MIL-STD-883, Meth 1008, Cond C, 150°C, 24 hours min.
4	Thermal Shock	MIL-STD-883, Meth 1011, Cond A	N/A	N/A	N/A	N/A
5	Temperature Cycle	MIL-STD-883, Meth 1010, Cond B	MIL-STD-883, Meth 1010, Cond B	MIL-STD-883, Meth 1010, Cond B	MIL-STD-883, Meth 1010, Cond B	MIL-STD-883, Meth 1010, Cond B
6	Constant Acceleration	MIL-STD-883, Meth 2001, Cond A, Y1 plane only, 5000 g's	MIL-STD-883, Meth 2001, Cond A, Y1 plane only, 5000 g's	MIL-STD-883, Meth 2001, Cond A, Y1 plane only, 5000 g's	N/A	N/A
7	Seal: Fine Leak	MIL-STD-883, Meth 1014, Cond A2	MIL-STD-883, Meth 1014, Cond A2	MIL-STD-883, Meth 1014, Cond A2	MIL-STD-883, Meth 1014, Cond A2	MIL-STD-883, Meth 1014, Cond A2
8	Seal: Gross Leak	MIL-STD-883, Meth 1014, Cond C	MIL-STD-883, Meth 1014, Cond C	MIL-STD-883, Meth 1014, Cond C	MIL-STD-883, Meth 1014, Cond C	MIL-STD-883, Meth 1014, Cond C
9	Particle Impact Noise Detection	MIL-STD-883, Meth 2020, Cond B	N/A	N/A	N/A	N/A
10	Electrical Test (Pre Burn-in) Input current-power Output waveform Output voltage-power As specified	MIL-PRF-55310, Par. 4.8.5 MIL-PRF-55310, Par. 4.8.20 MIL-PRF-55310, Par. 4.8.21 Customer PO	N/A N/A N/A Customer PO	N/A N/A N/A Customer PO	N/A N/A N/A Customer PO	N/A N/A N/A Customer PO
11	Burn-In (load)	+125°C, nominal supply voltage and burn-in load, 240 hours minimum	+125°C, nominal supply voltage and burn-in load, 160 hours minimum	+125°C, nominal supply voltage and burn-in load, 160 hours minimum	+25°C, nominal supply voltage and burn-in load, 160 hours minimum	N/A
12	Electrical Test (Pre Burn-in) Input current-power Output waveform Output voltage-power As specified	Nominal and extreme supply voltages, specified load, +23°C and temperature extremes. MIL-PRF-55310, Par. 4.8.5 MIL-PRF-55310, Par. 4.8.20 MIL-PRF-55310, Par. 4.8.21 Customer PO	Nominal supply voltages, specified load, +23°C and frequency verified at the temperature extremes. MIL-PRF-55310, Par. 4.8.5 MIL-PRF-55310, Par. 4.8.20 MIL-PRF-55310, Par. 4.8.21 Customer PO	Nominal supply voltages, specified load, +23°C and frequency verified at the temperature extremes. MIL-PRF-55310, Par. 4.8.5 MIL-PRF-55310, Par. 4.8.20 MIL-PRF-55310, Par. 4.8.21 Customer PO	Nominal supply voltages, specified load, +23°C and frequency verified at the temperature extremes. MIL-PRF-55310, Par. 4.8.5 MIL-PRF-55310, Par. 4.8.20 MIL-PRF-55310, Par. 4.8.21 Customer PO	Nominal supply voltages, specified load, +23°C. MIL-PRF-55310, Par. 4.8.5 MIL-PRF-55310, Par. 4.8.20 MIL-PRF-55310, Par. 4.8.21 Customer PO
13	Radiographic Inspection	MIL-STD-883, Meth 2012	N/A	N/A	N/A	N/A

TABLE 2 - Class 2 Test Matrix

SIZE A	CODE IDENT NO. 00136	THIRD ANGLE PROJECTION 	UNSPECIFIED TOLERANCES N/A	DWG NO. OS-80001	REV. B	SHEET 9
------------------	--------------------------------	---	--------------------------------------	----------------------------	------------------	-------------------

Enclosure: Type B (Class 1)

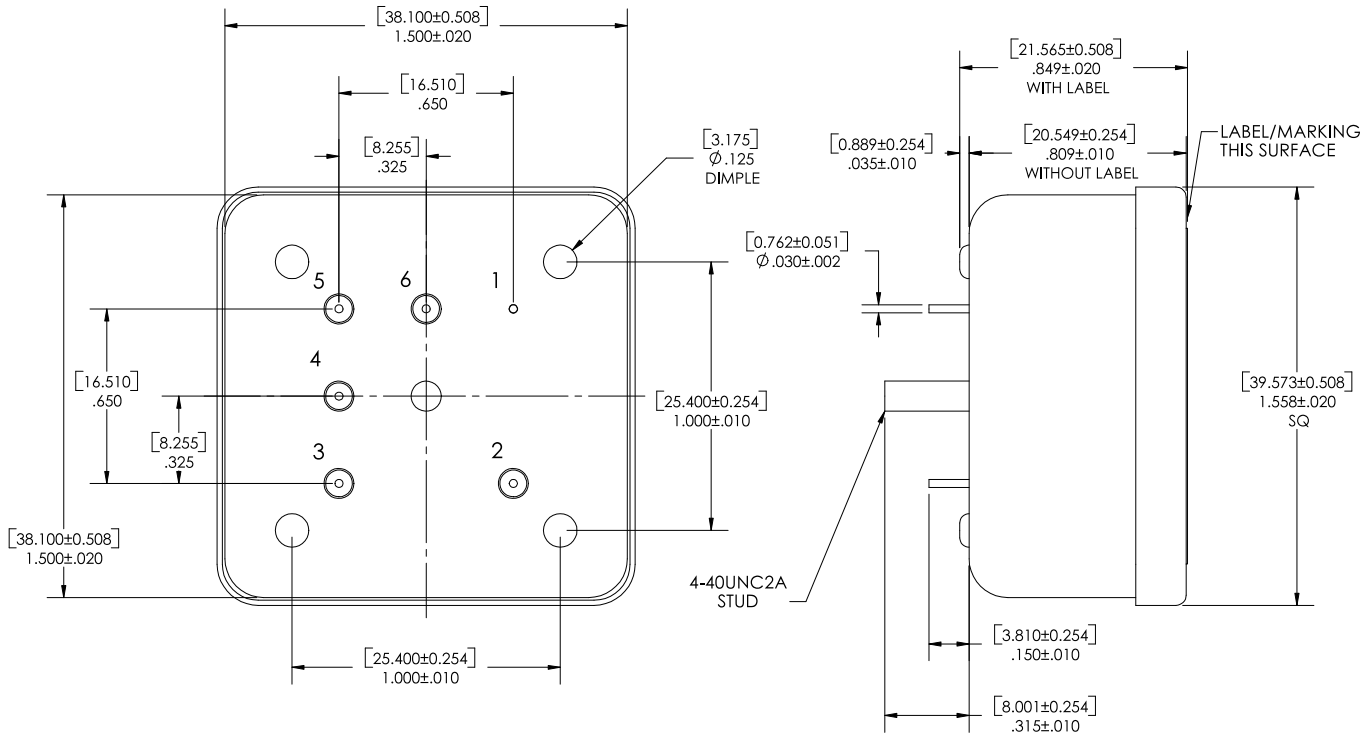

Material: CRS	
Finish: Hot Solder Dip per MIL-F-14072	
Weight: < 125 grams	
Pin Connections	
1	CASE GROUND
2	EFC
3	RF OUTPUT
4	INPUT VOLTAGE, OVEN
5	INPUT VOLTAGE, OSCILLATOR
6	OVEN READY INDICATOR (If Required)

Figure 1

SIZE A	CODE IDENT NO. 00136	THIRD ANGLE PROJECTION 	UNSPECIFIED TOLERANCES N/A	DWG NO. OS-80001	REV. B	SHEET 10
------------------	--------------------------------	---	--------------------------------------	----------------------------	------------------	--------------------

Enclosure: Type C (Class 2)

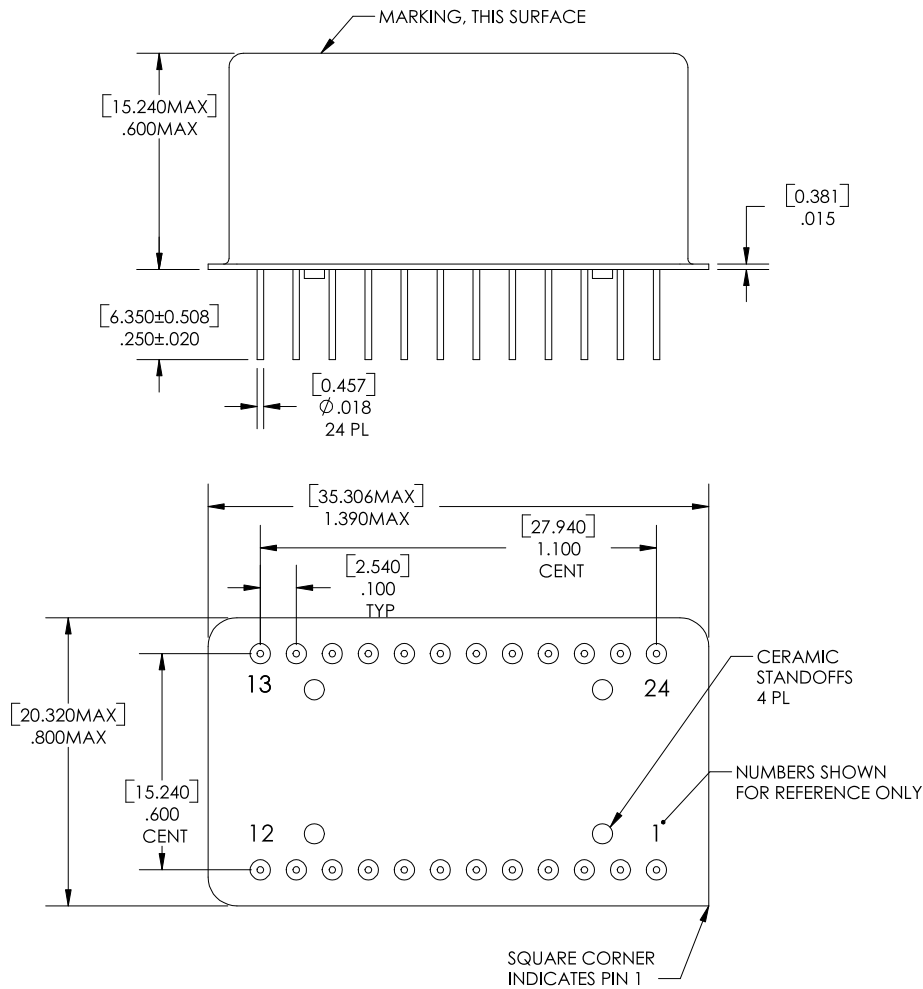

Material: Kovar per ASTM F-15	
Finish: Gold plating per MIL-G-45204, Type III, Grade A, Class 1 over electrodeposited nickel per QQ-N-290, Class 1 except that the plating thickness shall be 100 to 250 microinches.	
Weight: < 30 grams	
Pin Connections	
1	EFC
2-11	N/C
12	CASE GROUND
13	RF OUTPUT
14-23	N/C
24	INPUT VOLTAGE

Figure 2

SIZE A	CODE IDENT NO. 00136	THIRD ANGLE PROJECTION 	UNSPECIFIED TOLERANCES N/A	DWG NO. OS-80001	REV. B	SHEET 11
------------------	--------------------------------	---	--------------------------------------	----------------------------	------------------	--------------------

Enclosure: Type D (Class 3)

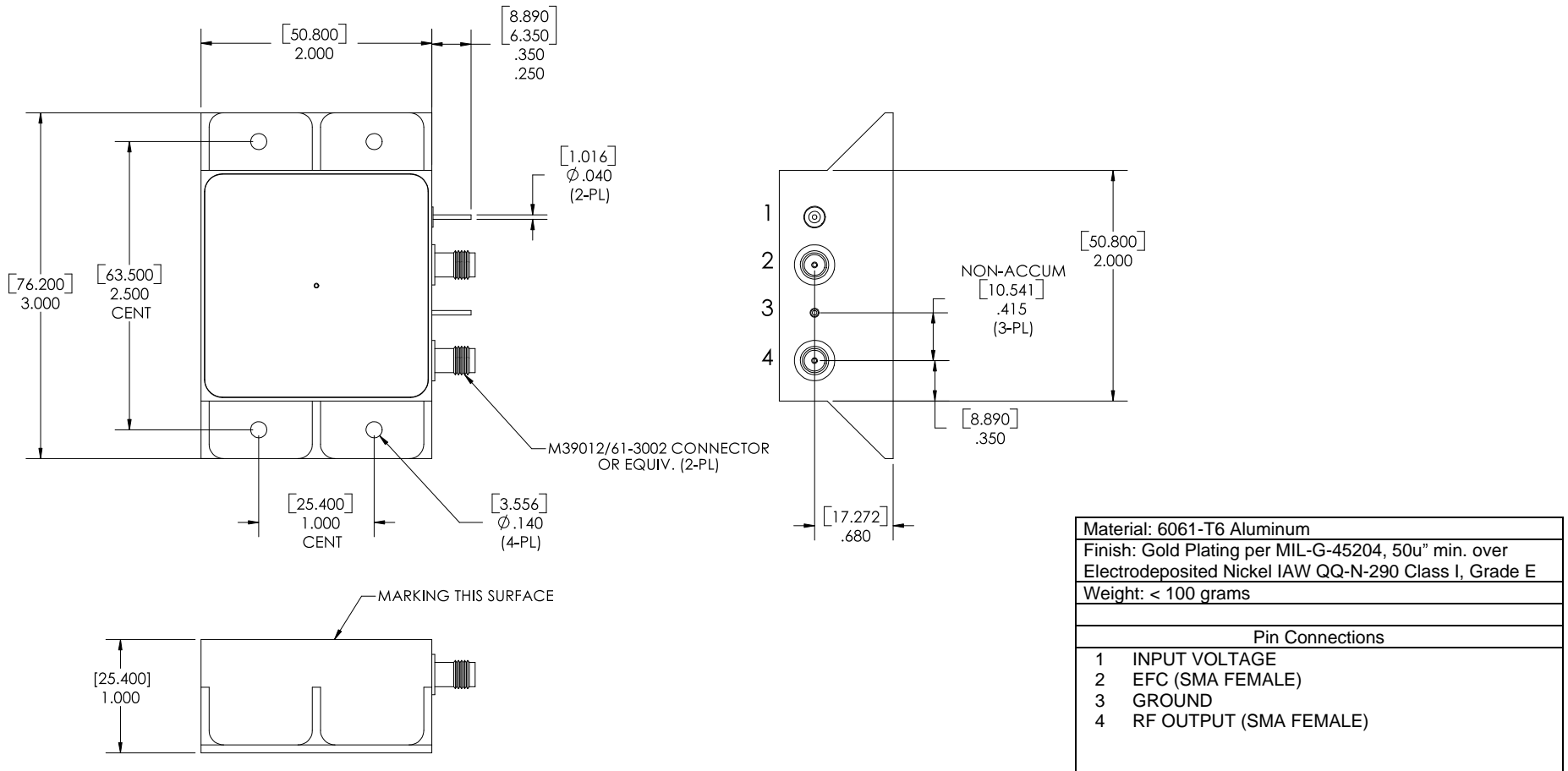

Figure 3

SIZE A	CODE IDENT NO. 00136	THIRD ANGLE PROJECTION 	UNSPECIFIED TOLERANCES N/A	DWG NO. OS-80001	REV. B	SHEET 12
------------------	--------------------------------	---	--------------------------------------	----------------------------	------------------	--------------------

ORDER ENTRY SHEET DETAILED REQUIREMENTS

C499

XXXX

Base
Model #

Oscillator
Class
(See 1.2.2)

Radiation
Environment
(See 1.2.3)

Temperature
Range
(See 1.2.4)

Dash
Number
(See 1.2.5)

Screening
Option
(See 1.2.6)

ELECTRICAL REQUIREMENTS^{1,2}

Parameter	Nominal Value	Limit (min.)	Limit (max.)	Unit	OPTIONS / RANGES
Frequency (Fo)				MHz	1MHz -125MHz
Set-on Tolerance				Hz	
Input Voltage 1				VDC	5V,12V,15V
Input Power 1					
Turn-on				W	
Steady State @ +25°C				W	
Steady State @ Minimum Operating Temperature				W	
Input Voltage 2				VDC	5V,12V,15V
Input Power 2					
Turn-on				W	
Steady State @ +25°C				W	
Steady State @ Minimum Operating Temperature				W	
RF Output Power				dBm	0 to +10dBm
Harmonics				dBc	
Spurious (Fo ±1MHz)				dBc	
Spurious (DC to 1.6GHz)				dBc	
Electronic Frequency Control					
Input Voltage Range				V	
Frequency Deviation				ΔF/F	
Slope	Negative or Positive			---	
Linearity				%	
Oven Ready Indicator					
Turn-on				V	
Steady State				V	

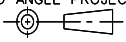
SIZE A	CODE IDENT NO. 00136	THIRD ANGLE PROJECTION 	UNSPECIFIED TOLERANCES N/A	DWG NO. OS-80001	REV. B	SHEET 13
------------------	--------------------------------	---	--------------------------------------	----------------------------	------------------	--------------------

FREQUENCY STABILITY^{1,2,4}

Parameter	Limit (max.)	Unit	Condition
Frequency vs. Temperature		$\Delta F/F$	
Warm-up Time			
Temperature = +25°C		$\Delta F/F$	ΔF , ____ minutes to ____ minutes after turn-on
Temperature = Minimum Operating Temperature		$\Delta F/F$	ΔF , ____ minutes to ____ minutes after turn-on
Frequency vs. Voltage		$\Delta F/F$	
Frequency vs. Load		$\Delta F/F$	
Aging			
Daily		$\Delta F/F$	At time of shipment
Yearly		$\Delta F/F$	
Other		$\Delta F/F$	
Phase Noise (Static)			
1 Hz		dBc/Hz	
10 Hz		dBc/Hz	
100 Hz		dBc/Hz	
1 kHz		dBc/Hz	
10 kHz		dBc/Hz	
100 kHz and Above		dBc/Hz	
Short Term Stability (Static)			
$\tau = 0.01$ sec.		$\Delta F/F$	
$\tau = 0.1$ sec.		$\Delta F/F$	
$\tau = 1.0$ sec		$\Delta F/F$	
$\tau = 10.0$ sec.		$\Delta F/F$	
Acceleration Sensitivity (2g tip-over)			
X axis		ppb/g	
Y axis		ppb/g	
Z axis		ppb/g	
Total gamma		ppb/g	

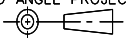
SIZE A	CODE IDENT NO. 00136	THIRD ANGLE PROJECTION 	UNSPECIFIED TOLERANCES N/A	DWG NO. OS-80001	REV. B	SHEET 14
------------------	--------------------------------	---	--------------------------------------	----------------------------	------------------	--------------------

MECHANICAL SPECIFICATIONS^{1,4}

Parameter	Type	Comment
Customer Specified Enclosure	A	Customer Outline Required
Class 1 Oscillators	B	See Figure 1
Class 2 Oscillators	C	See Figure 2
Class 3 Oscillators	D	See Figure 3

ENVIRONMENTAL CONDITIONS^{1,4}

Parameter	Limit (min.)	Limit (max.)	Unit	Condition
Operating Temperature Range			°C	
Extended Temperature Range			°C	Operational, non-specification compliant
Storage Temperature Range			°C	
Radiation			Rad(Si)	
Random Vibration	MIL-STD-202, Method 214, Test Condition ____, Letter ____			
Vibration, High Frequency	MIL-STD-202, Method 204, Test Condition ____			
Shock	MIL-STD-202, Method 213, Test Condition ____			
Ambient Pressure	MIL-STD-202, Method 105, Test Condition ____			
Constant Acceleration	MIL-STD-202, Method 212, Test Condition ____			
Humidity (Steady State)	MIL-STD-202, Method 103, Test Condition ____			

ADDITIONAL INFORMATION⁴

Parameter	Required	Condition / Comment
Group A Inspection		
Group B Inspection		
Group C Inspection		
Internal Water-Vapor Content (RGA)		
Destruct Physical Analysis (DPA)		
Reliability Predictions (MTBF) ³		Hours: _____
Manufacturer's Parts List		
Deliverable Process Identification Documentation (PID)		
Program Management		
Customer Source Inspection (pre-cap / final)		
OTHER: (List Below)		

Notes:

- Not all options and codes are available at all frequencies and configurations.
- Unless otherwise stated, all values are valid after warm-up time and refer to typical conditions for supply voltage, frequency control voltage, load, temperature (25°C)
- Mean Time Between Failure calculated IAW MIL-HDBK-217
- Any field left blank will be assigned N/A. See paragraph 6.2 for additional information.

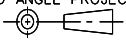
SIZE A	CODE IDENT NO. 00136	THIRD ANGLE PROJECTION 	UNSPECIFIED TOLERANCES N/A	DWG NO. OS-80001	REV. B	SHEET 15
------------------	--------------------------------	---	--------------------------------------	----------------------------	------------------	--------------------