

## AD96685/AD96687

### FEATURES

**Fast: 2.5 ns Propagation Delay**  
**Low Power: 118 mW per Comparator**  
**Packages: DIP, TO-100, SOIC, PLCC**  
**Power Supplies: +5 V, -5.2 V**  
**Logic Compatibility: ECL**  
**MIL-STD-883 Versions Available**  
**50 ps Delay Dispersion**

### APPLICATIONS

**High Speed Triggers**  
**High Speed Line Receivers**  
**Threshold Detectors**  
**Window Comparators**  
**Peak Detectors**

### GENERAL DESCRIPTION

The AD 96685 and AD 96687 are ultrafast voltage comparators. The AD 96685 is a single comparator with 2.5 ns propagation delay; the AD 96687 is an equally fast dual comparator. Both devices feature 50 ps propagation delay dispersion which is a particularly important characteristic of high speed comparators. It is a measure of the difference in propagation delay under differing overdrive conditions.

A fast, high precision differential input stage permits consistent propagation delay with a wide variety of signals in the common mode range from -2.5 V to +5 V. Outputs are complementary digital signals fully compatible with ECL 10K and 10KH logic

### AD96685 FUNCTIONAL BLOCK DIAGRAM

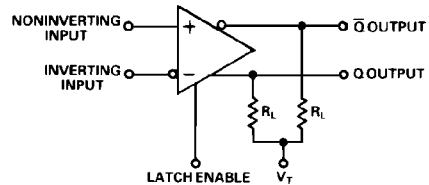

### AD96687 FUNCTIONAL BLOCK DIAGRAM

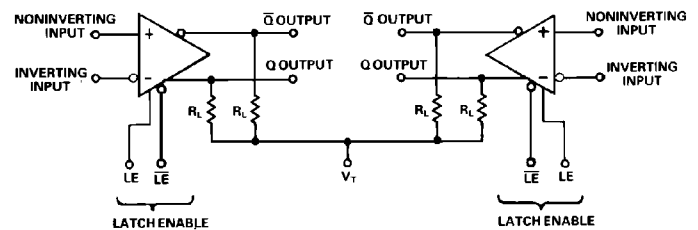

THE OUTPUTS ARE OPEN EMITTERS, REQUIRING EXTERNAL PULL-DOWN RESISTORS. THESE RESISTORS MAY BE IN THE RANGE OF 50 $\Omega$  - 200 $\Omega$  CONNECTED TO -2.0V, OR 200 $\Omega$  - 2000 $\Omega$ .

families. The outputs provide sufficient drive current to directly drive transmission lines terminated in 50  $\Omega$  to -2 V. A level-sensitive latch input is included which permits tracking, track-hold, or sample-and-hold modes of operation.

The AD 96685 and AD 96687 are available in both industrial, -25°C to +85°C, and military temperature ranges. Industrial range devices are available in 16-pin DIP, SOIC, and 20-lead PLCC; additionally, the AD 96685 is available in a 10-pin, TO-100 metal can.

REV. C

Information furnished by Analog Devices is believed to be accurate and reliable. However, no responsibility is assumed by Analog Devices for its use, nor for any infringements of patents or other rights of third parties which may result from its use. No license is granted by implication or otherwise under any patent or patent rights of Analog Devices.

# AD96685/AD96687—SPECIFICATIONS

## ABSOLUTE MAXIMUM RATINGS<sup>1</sup>

Positive Supply Voltage (+V <sub>S</sub> )	+6.5 V
Negative Supply Voltage (-V <sub>S</sub> )	-6.5 V
Input Voltage Range <sup>2</sup>	±5 V
Differential Input Voltage	5.5 V
Latch Enable Voltage	-V <sub>S</sub> to 0 V
Output Current	30 mA
Operating Temperature Range <sup>3</sup>	
AD 96685/87/BH/BQ/BP/BR	-25°C to +85°C
AD 96685/87/TQ	-55°C to +125°C
Storage Temperature Range	-55°C to +150°C
Junction Temperature	+175°C
Lead Soldering Temperature (10 sec)	+300°C

## EXPLANATION OF TEST LEVELS

Test Level	
I	100% production tested.
II	100% production tested at +25°C, and sample tested at specified temperatures.
III	Sample tested only.
IV	Parameter is guaranteed by design and characterization testing.
V	Parameter is a typical value only.
VI	All devices are 100% production tested at +25°C; 100% production tested at temperature extremes for extended temperature devices; sample tested at temperature extremes for commercial/industrial devices.

## ELECTRICAL CHARACTERISTICS (Positive Supply Voltage = +5.0 V; Negative Supply Voltage = -5.2 V, unless otherwise noted)

Parameter	Temp	Test Level	Industrial Temp. Range -25°C to +85°C			Military Temp. Range -55°C to +125°C			Units			
			AD 96685BH/BQ/BP/BR	AD 96687BQ/BP/BR	AD 96685TQ	AD 96687TQ						
			Min	Typ	Max	Min	Typ	Max	Min	Typ	Max	
<b>INPUT CHARACTERISTICS</b>												
Input Offset Voltage <sup>4</sup>	+25°C	I	1	2		1	2		1	2		mV
	Full	VI		3			3			3		mV
Input Offset Drift	Full	V	20			20			20			μV/°C
Input Bias Current	+25°C	I	7	10		7	10		7	10		μA
	Full	VI		13			13			16		μA
Input Offset Current	+25°C	I	0.1	1.0		0.1	1.0		0.1	1.0		μA
	Full	VI		1.2			1.2			1.2		μA
Input Resistance	+25°C	V	200			200			200			kΩ
Input Capacitance	+25°C	V	2			2			2			pF
Input Voltage Ranges	Full	VI	-2.5	+5.0		-2.5	+5.0		-2.5	+5.0		V
Common-Mode Rejection Ratio	Full	VI	80	90		80	90		80	90		dB
<b>ENABLE INPUT</b>												
Logic "1" Voltage	Full	VI	-1.1			-1.1			-1.1			V
Logic "0" Voltage	Full	VI		-1.5			-1.5			-1.5		V
Logic "1" Current	Full	VI		40			40			40		μA
Logic "0" Current	Full	VI		5			5			5		μA
<b>DIGITAL OUTPUTS<sup>6</sup></b>												
Logic "1" Voltage	Full	VI	-1.1			-1.1			-1.1			V
Logic "0" Voltage	Full	VI		-1.5			-1.5			-1.5		V
<b>SWITCHING PERFORMANCES</b>												
Propagation Delays <sup>7</sup>												
Input to Output HIGH	+25°C	IV	2.5	3.5		2.5	3.5		2.5	3.5		ns
Input to Output LOW	+25°C	IV	2.5	3.5		2.5	3.5		2.5	3.5		ns
Latch Enable to Output HIGH	+25°C	IV	2.5	3.5		2.5	3.5		2.5	3.5		ns
Latch Enable to Output LOW	+25°C	IV	2.5	3.5		2.5	3.5		2.5	3.5		ns
Dispersions <sup>8</sup>												
Latch Enable	+25°C	V	50			50			50			ps
Minimum Pulse Width												
Minimum Setup Time	+25°C	IV	2.0	3.0		2.0	3.0		2.0	3.0		ns
Minimum Hold Time	+25°C	IV	0.5	1.0		0.5	1.0		0.5	1.0		ns
Power Supply <sup>9</sup>												
Positive Supply Current (+5.0 V)	Full	VI	8	9		15	18		8	9		mA
Negative Supply Current (-5.2 V)	Full	VI	15	18		31	36		15	18		mA
Power Supply Rejection Ratio <sup>10</sup>	Full	VI	60	70		60	70		60	70		dB

### NOTES

<sup>1</sup>Absolute maximum ratings are limiting values, may be applied individually, and beyond which serviceability of the circuit may be impaired. Functional operation under any of these conditions is not necessarily implied. Exposure to absolute maximum rating conditions for extended periods may affect device reliability.

<sup>2</sup>Under no circumstances should the input voltages exceed the supply voltages.

<sup>3</sup>Typical thermal impedances...

AD 96685 M etal Can	θ <sub>JA</sub> = 172°C/W ; θ <sub>JC</sub> = 52°C/W
AD 96685 Ceramic	θ <sub>JA</sub> = 115°C/W ; θ <sub>JC</sub> = 57°C/W
AD 96685 SO IC	θ <sub>JA</sub> = 170°C/W ; θ <sub>JC</sub> = 60°C/W
AD 96685 FLCC	θ <sub>JA</sub> = 88°C/W ; θ <sub>JC</sub> = 45°C/W
AD 96687 Ceramic	θ <sub>JA</sub> = 115°C/W ; θ <sub>JC</sub> = 57°C/W
AD 96687 SO IC	θ <sub>JA</sub> = 92°C/W ; θ <sub>JC</sub> = 47°C/W
AD 96687 FLCC	θ <sub>JA</sub> = 81°C/W ; θ <sub>JC</sub> = 45°C/W

<sup>4</sup>R<sub>S</sub> = 100 Ω.

<sup>5</sup>Input Voltage Range can be extended to -3.3 V if -V<sub>S</sub> = -6.0 V.

<sup>6</sup>Outputs terminated through 50 Ω to -2.0 V.

<sup>7</sup>Propagation delays measured with 100 mV pulse (10 mV overdrive), to 50% transition point of the output.

<sup>8</sup>Change in propagation delay from 100 mV to 1 V input overdrive.

<sup>9</sup>Supply voltages should remain stable within ±5% for normal operation.

<sup>10</sup>Measured at ±5% of +V<sub>S</sub> and -V<sub>S</sub>.

Specifications subject to change without notice.

FUNCTIONAL DESCRIPTION

Pin Name	Description
+V <sub>S</sub>	Positive supply terminal, nominally +5.0 V.
NON INVERTING INPUT	Noninverting analog input of the differential input stage. The NON INVERTING INPUT must be driven in conjunction with the INVERTING INPUT.
INVERTING INPUT	Inverting analog input of the differential input stage. The INVERTING INPUT must be driven in conjunction with the NON INVERTING INPUT.
LATCH ENABLE	In the "compare" mode (logic HIGH), the output will track changes at the input of the comparator. In the "latch" mode (logic LOW), the output will reflect the input state just prior to the comparator being placed in the "latch" mode. LATCH ENABLE must be driven in conjunction with LATCH ENABLE for the AD96687.
<u>LATCH ENABLE</u>	In the "compare" mode (logic HIGH), the output will track changes at the input of the comparator. In the "latch" mode (logic LOW), the output will reflect the input state just prior to the comparator being placed in the "latch" mode. LATCH ENABLE must be driven in conjunction with <u>LATCH ENABLE</u> for the AD96687.
-V <sub>S</sub>	Negative supply terminal, nominally -5.2 V.
Q	One of two complementary outputs. Q will be at logic HIGH if the analog voltage at the NON INVERTING INPUT is greater than the analog voltage at the INVERTING INPUT (provided the comparator is in the "compare" mode). See LATCH ENABLE and <u>LATCH ENABLE</u> (AD96687 only) for additional information.
<u>Q</u>	One of two complementary outputs. <u>Q</u> will be at logic LOW if the analog voltage at the NON INVERTING INPUT is greater than the analog voltage at the INVERTING INPUT (provided the comparator is in the "compare" mode). See LATCH ENABLE and <u>LATCH ENABLE</u> (AD96687 only) for additional information.
GROUND 1	One of two grounds, but primarily associated with the digital ground. Both grounds should be connected together near the comparator.
GROUND 2	One of two grounds, but primarily associated with the analog ground. Both grounds should be connected together near the comparator.

PIN DESIGNATIONS

AD96685BQ/TQ/BR

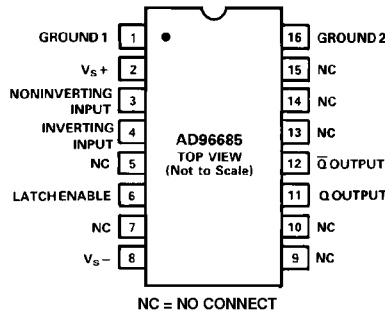

AD96687BQ/TQ/BR

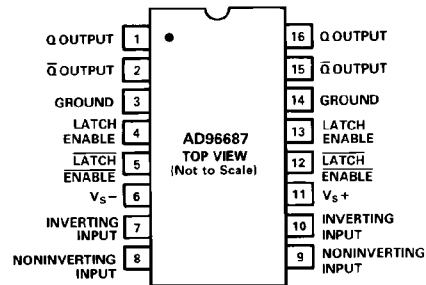

AD96685BP

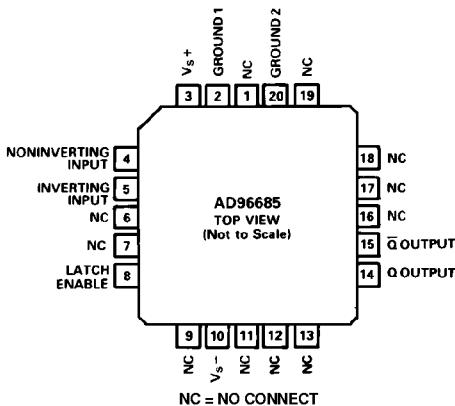

AD96685BH

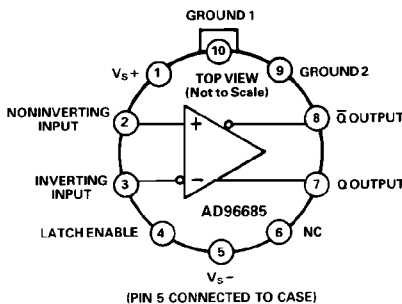

AD96687BP

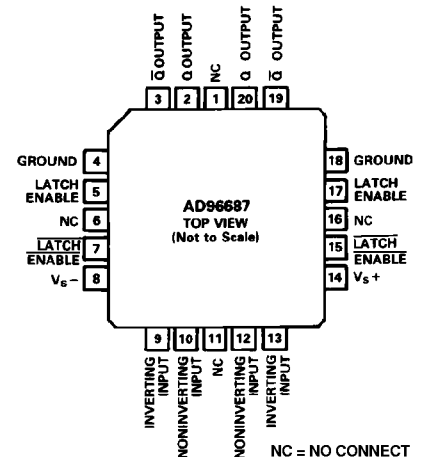

SYSTEM TIMING DIAGRAM

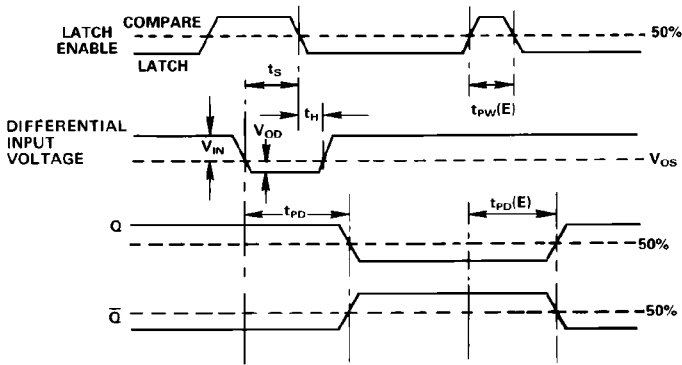

- t<sub>s</sub> - Minimum Setup Time
- t<sub>H</sub> - Minimum Hold Time
- t<sub>PD</sub> - Input to Output Delay
- t<sub>PD(E)</sub> - LATCH ENABLE to Output Delay
- t<sub>PW(E)</sub> - Minimum LATCH ENABLE Pulse Width
- V<sub>OS</sub> - Input Offset Voltage
- V<sub>OD</sub> - Overdrive Voltage

DIE LAYOUT AND MECHANICAL INFORMATION

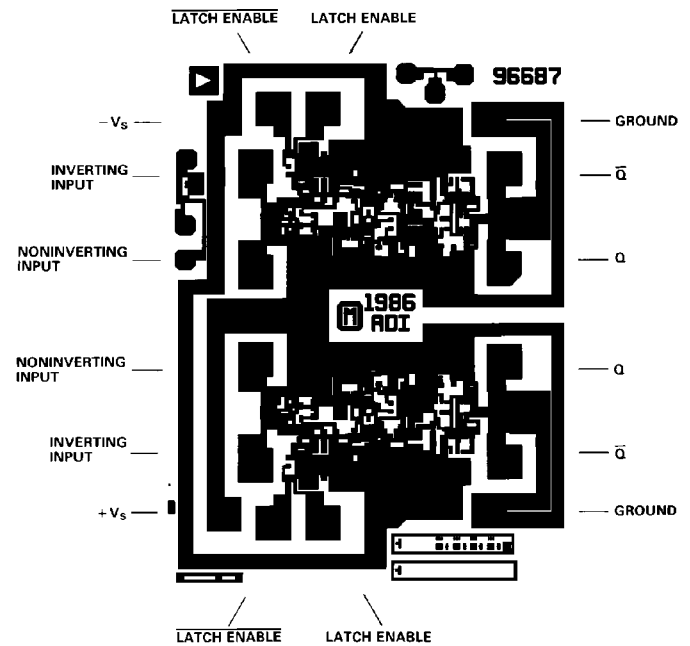
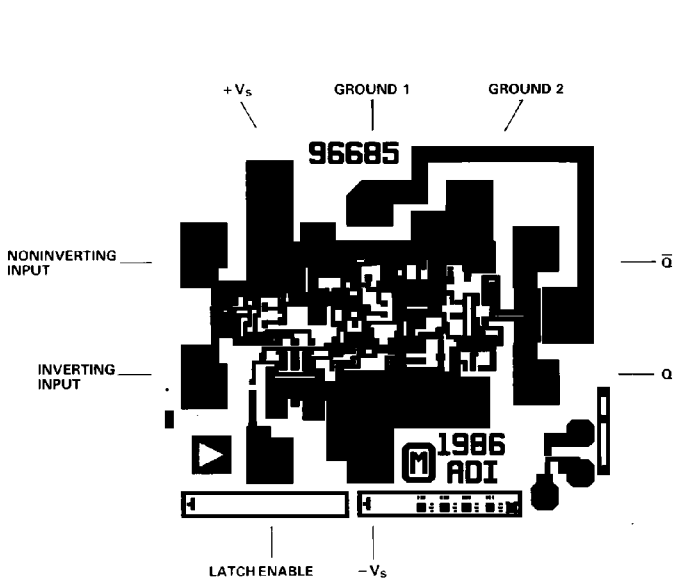

Die Dimensions (AD 96685) . . . . . 44 × 50 × 15 (±2) mils  
 Pad Dimensions . . . . . 4 × 4 mils  
 Metallization . . . . . Aluminum  
 Backing . . . . . None  
 Substrate Potential . . . . . -V<sub>S</sub>  
 Passivation . . . . . Oxynitride  
 Die Attach . . . . . Gold Eutectic  
 Bond Wire . . . . . 1.25 mil, Aluminum; Ultrasonic Bonding  
 or 1 mil, Gold, Gold Ball Bonding

Die Dimensions (AD 96687) . . . . . 77 × 60 × 15 (±2) mils  
 Pad Dimensions . . . . . 4 × 4 mils  
 Metallization . . . . . Aluminum  
 Backing . . . . . None  
 Substrate Potential . . . . . -V<sub>S</sub>  
 Passivation . . . . . Oxynitride  
 Die Attach . . . . . Gold Eutectic  
 Bond Wire . . . . . 1.25 mil, Aluminum; Ultrasonic Bonding  
 or 1 mil, Gold, Gold Ball Bonding

## ORDERING GUIDE

Model	Type	Temperature Range	Description	Package Options
AD 96685BH	Single	-25°C to +85°C	10-Pin Can, Industrial	H-10A
AD 96685BP	Single	-25°C to +85°C	20-Pin PLCC, Industrial	P-20A
AD 96685BQ	Single	-25°C to +85°C	16-Pin DIP, Industrial	Q-16
AD 96685BR	Single	-25°C to +85°C	16-Pin SOIC, Industrial	R-16A
AD 96685BP-REEL	Single	-25°C to +85°C	20-Pin PLCC, Industrial	P-20A
AD 96685TQ	Single	-55°C to +125°C	16-Pin DIP, Extended Temperature	Q-16
AD 96687BP	Dual	-25°C to +85°C	20-Pin PLCC, Industrial	P-20A
AD 96687BQ	Dual	-25°C to +85°C	16-Pin DIP, Industrial	Q-16
AD 96687BR	Dual	-25°C to +85°C	16-Pin SOIC, Industrial	R-16A
AD 96687BR-REEL	Dual	-25°C to +85°C	16-Pin SOIC, Industrial	R-16A
AD 96687TQ	Dual	-55°C to +125°C	16-Pin DIP, Extended Temperature	Q-16

### APPLICATIONS INFORMATION

The AD 96685/87 comparators are very high speed devices. Consequently, high speed design techniques must be employed to achieve the best performance. The most critical aspect of any AD 96685/87 design is the use of a low impedance ground plane.

Another area of particular importance is power supply decoupling. Normally, both power supply connections should be separately decoupled to ground through 0.1  $\mu\text{F}$  ceramic and 0.001  $\mu\text{F}$  mica capacitors. The basic design of comparator circuits makes the negative supply somewhat more sensitive to variations. As a result more attention should be placed on insuring a "clean" negative supply.

The LATCH ENABLE input is active LOW (latched). If the latching function is not used, the LATCH ENABLE input should be grounded (ground is an ECL logic HIGH). The LATCH ENABLE input of the AD 96687 should be tied to -2.0 V or left "floating," to disable the latching function. An alternate use of the LATCH ENABLE input is as a hysteresis control input. By varying the voltage at the LATCH ENABLE input for the AD 96685 and the differential voltage between both latch inputs for the AD 96687, small variations in the hysteresis can be achieved.

Occasionally, one of the two comparator stages within the AD 96687 will not be used. The inputs of the unused comparator should not be allowed to "float." The high internal gain may cause the output to oscillate (possibly affecting the other comparator which is being used) unless the output is forced into a fixed state. This is easily accomplished by insuring that the two inputs are at least one diode drop apart, while also grounding the LATCH ENABLE input.

The best performance will be achieved with the use of proper ECL terminations. The open-emitter outputs of the AD 96685/87 are designed to be terminated through 50  $\Omega$  resistors to -2.0 V, or any other equivalent ECL termination. If high speed ECL signals must be routed more than a few centimeters, MicroStrip or StripLine techniques may be required to insure proper transition times and prevent output ringing.

The AD 96685/87 have been specifically designed to reduce propagation delay dispersion over an input overdrive range of 100 mV to 1 V. Propagation delay dispersion is the change in propagation delay which results from a change in the degree of overdrive (how far the switching point is exceeded by the input). The overall result is a higher degree of timing accuracy since the AD 96685/87 is far less sensitive to input variations than most comparator designs.

### Typical Applications

#### HIGH SPEED SAMPLING CIRCUIT

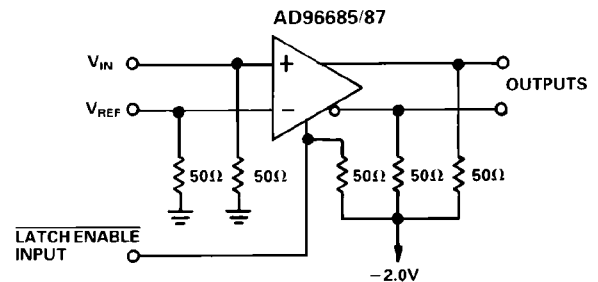

#### HIGH SPEED WINDOW COMPARATOR

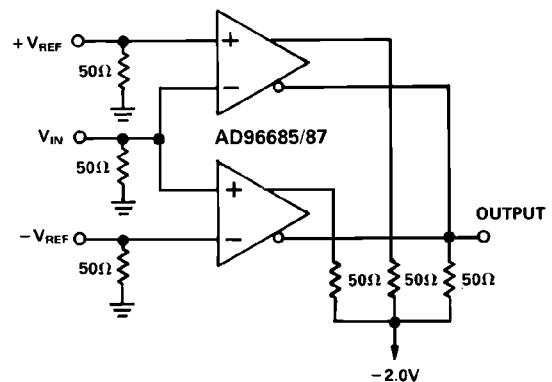

OUTLINE DIMENSIONS

Dimensions shown in inches and (mm).

16-Pin Ceramic DIP

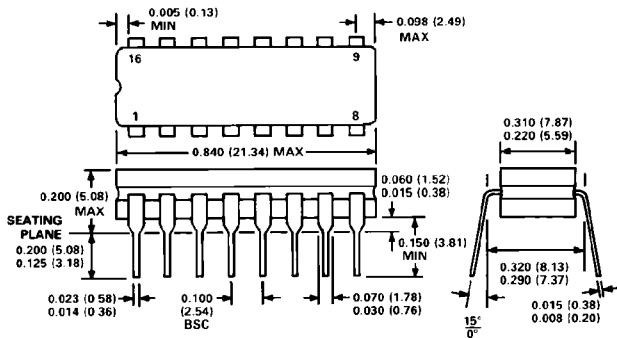

16-Pin SOIC

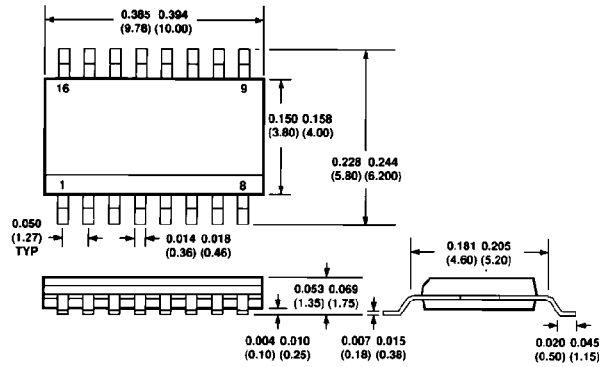

20-Pin LCC

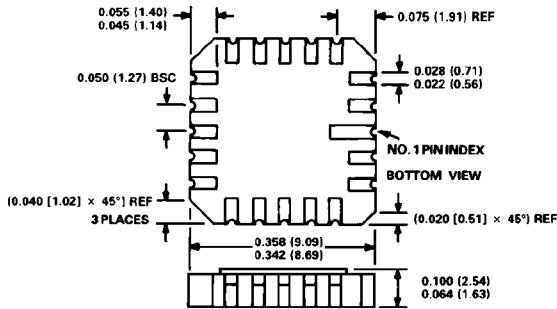

20-Pin PLCC

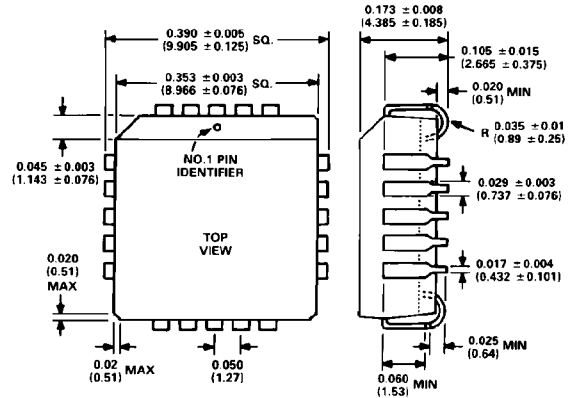

10-Pin TO-100 Metal Can

