

13 - 17 GHz 2.5 Watt, 25dB Power Amplifier

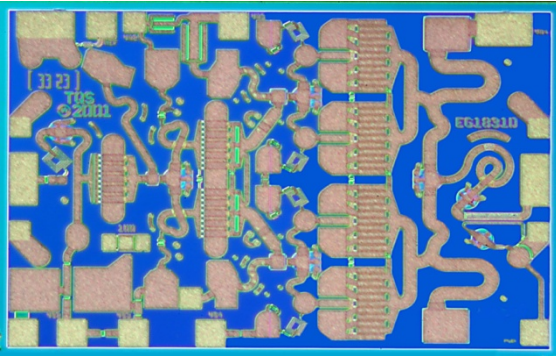

Key Features and Performance

- 34 dBm Midband Pout
- 25 dB Nominal Gain
- 7 dB Typical Input Return Loss
- 12 dB Typical Output Return Loss
- Built-in Directional Power Detector with Reference
- 0.25µm pHEMT Technology
- Bias Conditions: 7V, 640mA
- Chip dimensions:
2.03 x 1.39 x 0.10 mm
(0.080 x 0.055 x 0.004 inches)

Preliminary Measured Performance

Bias Conditions: Vd=7V Id=640mA

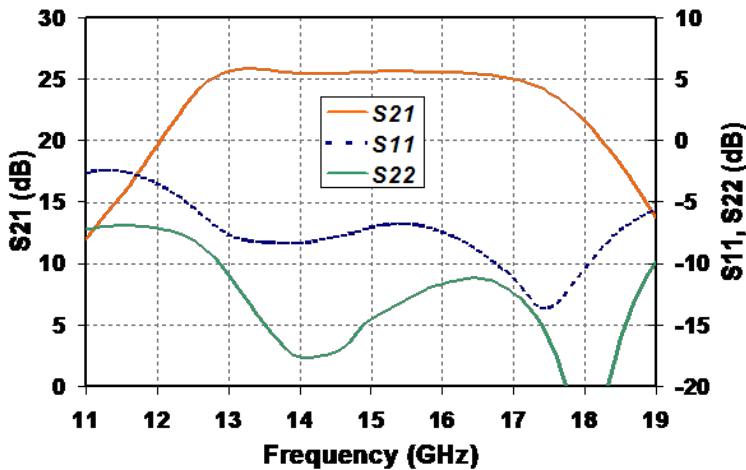

Primary Applications

- VSAT
- Point-to-Point

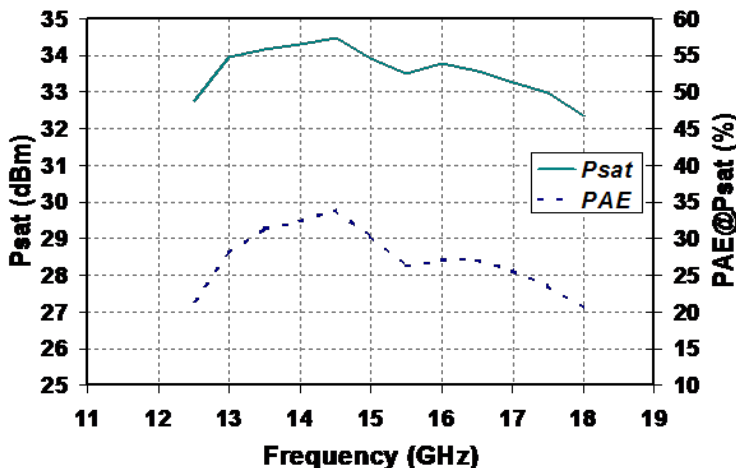

Datasheet subject to change without notice

TABLE I
MAXIMUM RATINGS

Symbol	Parameter <u>1/</u>	Value	Notes
V ⁺	Positive Supply Voltage	8 V	<u>2/</u>
V ⁻	Negative Supply Voltage Range	-5V to 0V	
I ⁺	Positive Supply Current (Quiescent)	1300 mA	<u>2/</u>
I _G	Gate Supply Current	18 mA	
P _{IN}	Input Continuous Wave Power	24 dBm	<u>2/</u>
P _D	Power Dissipation	10.5 W	<u>2/ 3/</u>
T _{CH}	Operating Channel Temperature	200 °C	<u>4/ 5/</u>
	Mounting Temperature (30 Seconds)	320 °C	
T _{STG}	Storage Temperature	-65 to 150 °C	

- 1/ These ratings represent the maximum operable values for this device.
- 2/ Combinations of supply voltage, supply current, input power, and output power shall not exceed P_D.
- 3/ When operated at this bias condition with a base plate temperature of 70°C, the median life is 2.3E4.
- 4/ These ratings apply to each individual FET.
- 5/ Junction operating temperature will directly affect the device median time to failure (T_m). For maximum life, it is recommended that junction temperatures be maintained at the lowest possible levels.

TABLE II
DC PROBE TEST
(T_A = 25 °C, Nominal)

NOTES	SYMBOL	LIMITS		UNITS
		MIN	MAX	
<u>1/</u>	I _{DSS}	80	381	mA
<u>1/</u>	G _M	175	425	mS
<u>2/</u>	V _P	0.5	1.5	V
<u>2/</u>	V _{BVGS}	8	30	V
<u>2/</u>	V _{BVGD}	13	30	V

- 1/ Measurements are performed on a 800µm FET.
- 2/ V_P, V_{BVGD}, and V_{BVGS} are negative.

TABLE III
RF CHARACTERIZATION TABLE
 (T_A = 25°C, Nominal)
 (V_d = 7V, I_d = 640mA ±5%)

SYMBOL	PARAMETER	TEST CONDITION	LIMITS	UNITS
			TYP	
Gain	Small Signal Gain	F = 13 – 17 GHz	25	dB
IRL	Input Return Loss	F = 13 – 17 GHz	7	dB
ORL	Output Return Loss	F = 13 – 17 GHz	12	dB
PWR	Output Power @ Pin = +15 dBm	F = 13 – 17 GHz	34	dBm

Note: Table III Lists the RF Characteristics of typical devices as determined by fixtured measurements.

**TABLE IV
THERMAL INFORMATION**

PARAMETER	TEST CONDITION	T _{CH} (°C)	θ _{JC} (°C/W)	T _m (HRS)
θ _{JC} Thermal Resistance (Channel to Backside)	V _D = 7V I _D = 640mA P _D = 4.48W	125.7	12.44	8.9E+6

Note: Assumes eutectic attach using 1.5mil 80/20 AuSn mounted to a 20mil CuMo carrier at 70°C baseplate temperature. Worst case condition with no RF applied, 100% of DC power is dissipated.

Median Lifetime (T_m) vs. Channel Temperature

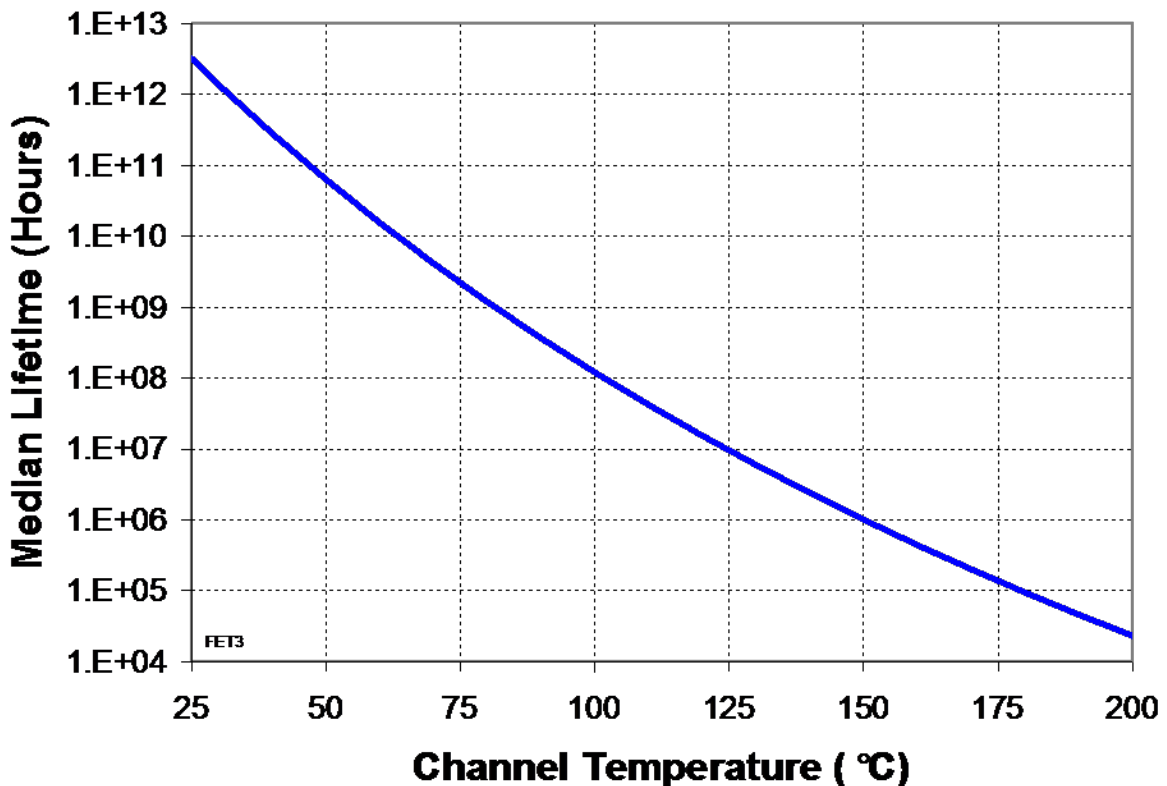

Typical Fixtured Performance

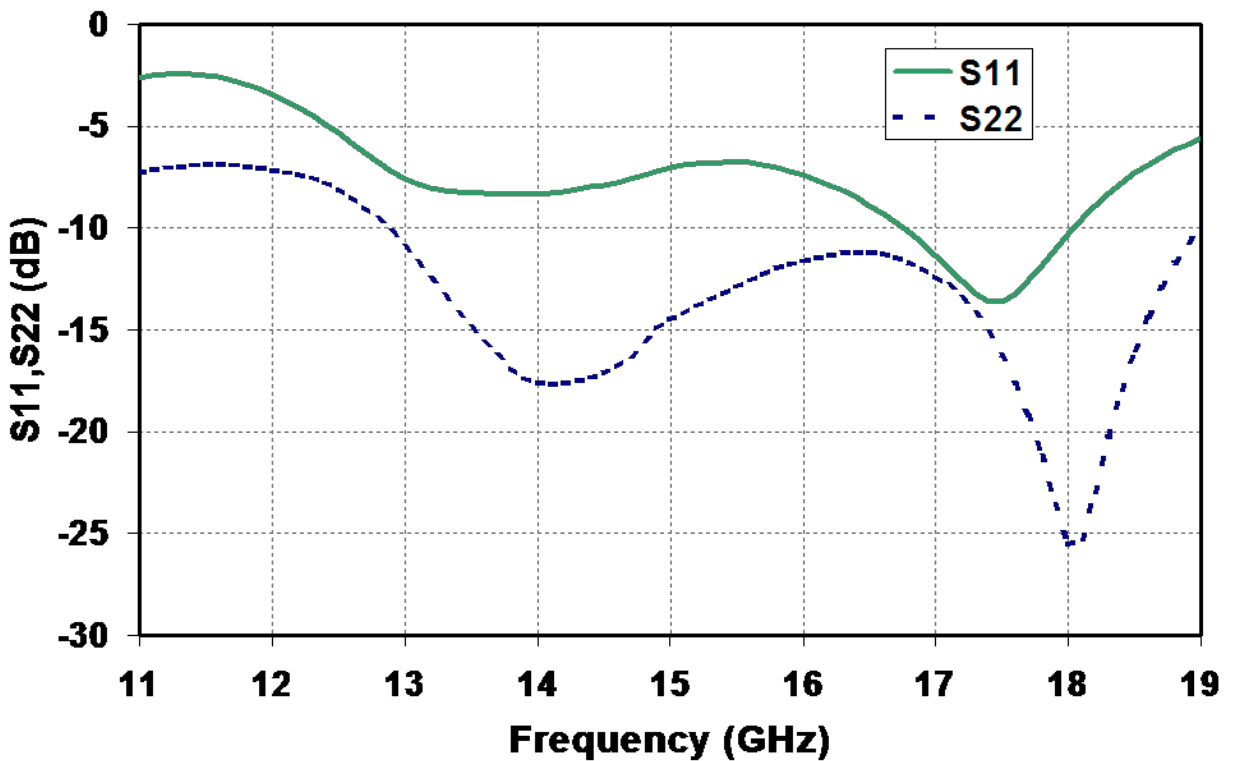
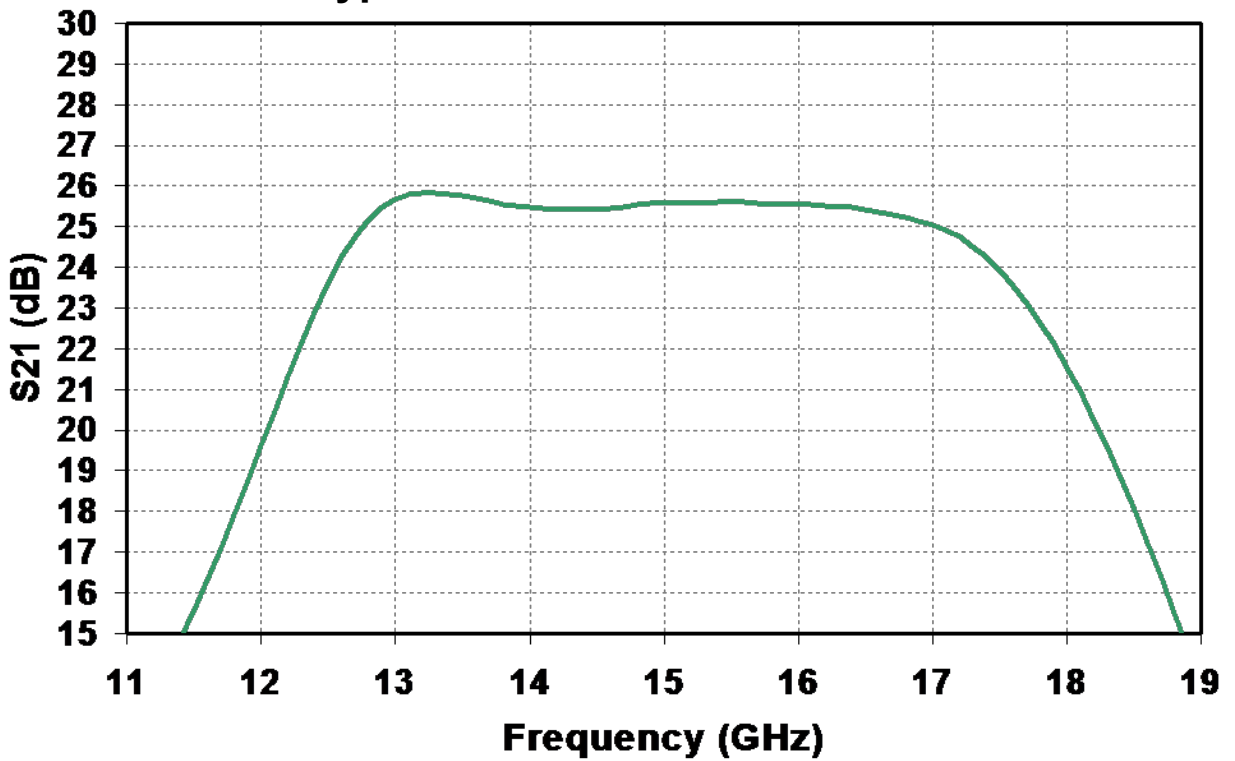

Typical Fixtured Performance

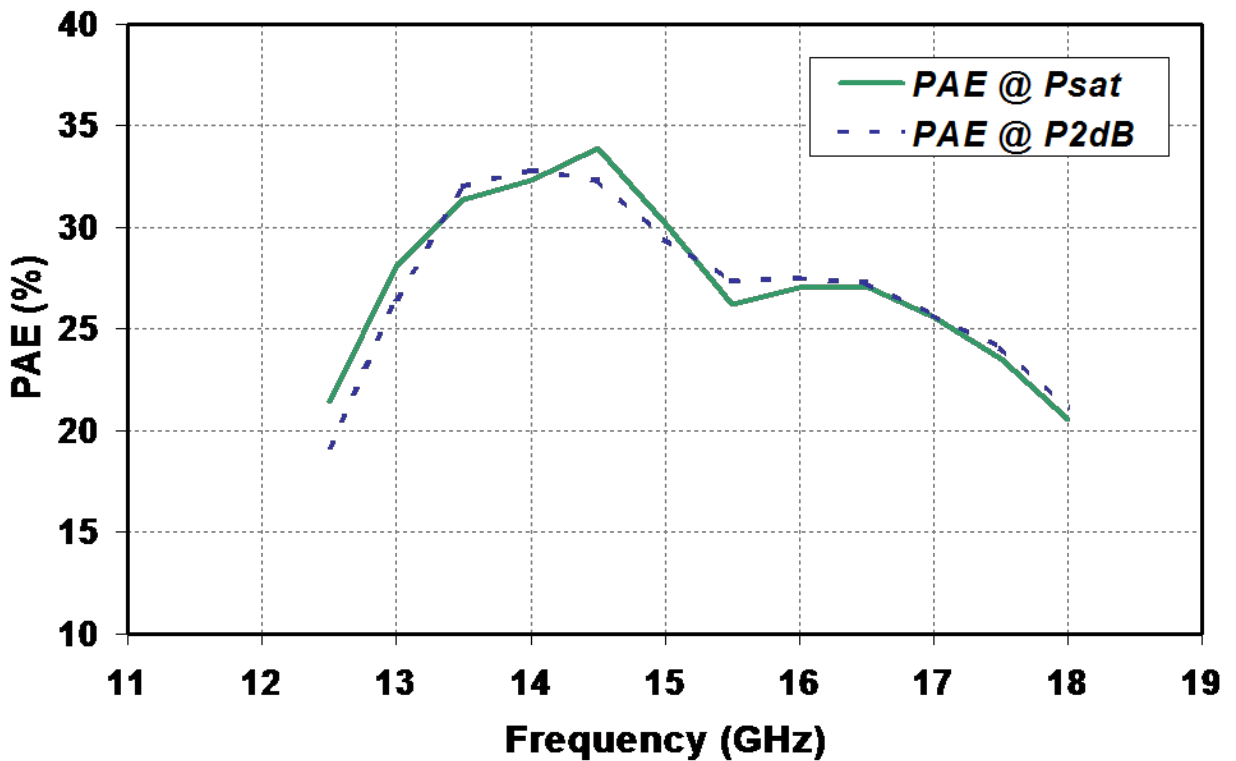
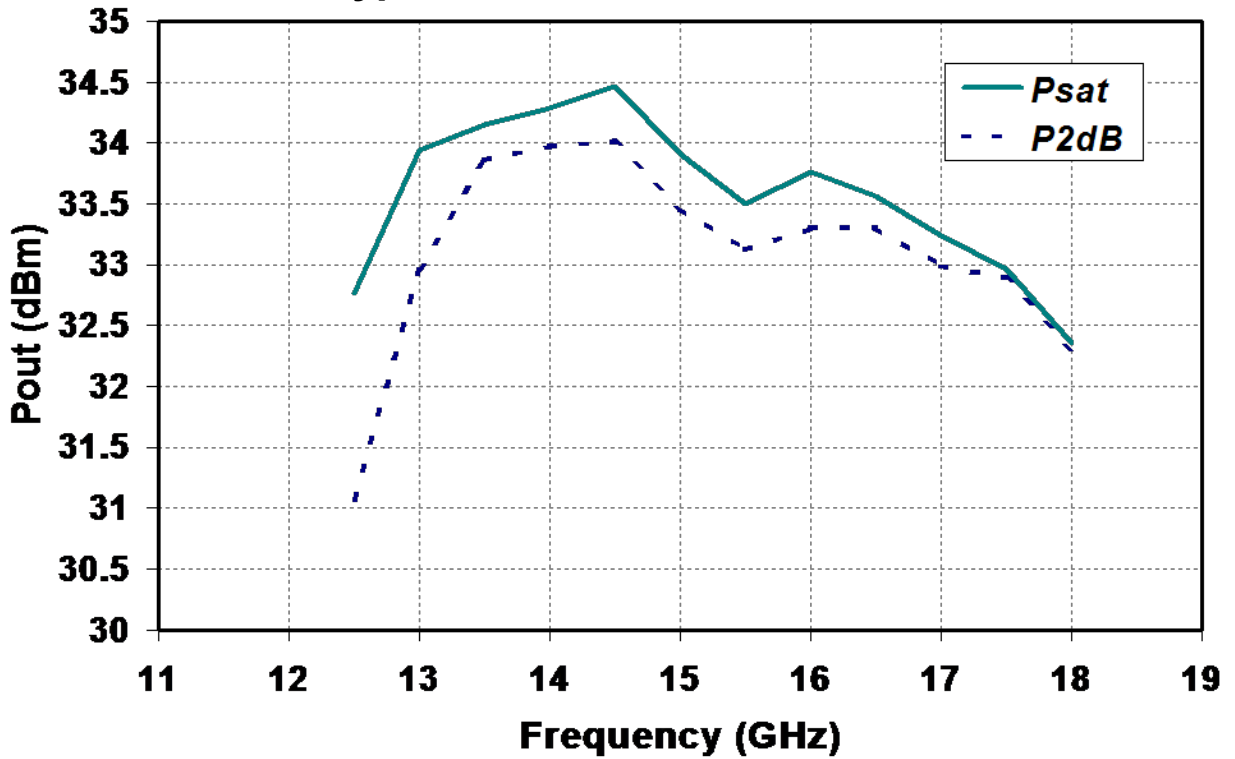

Typical Fixtured Performance

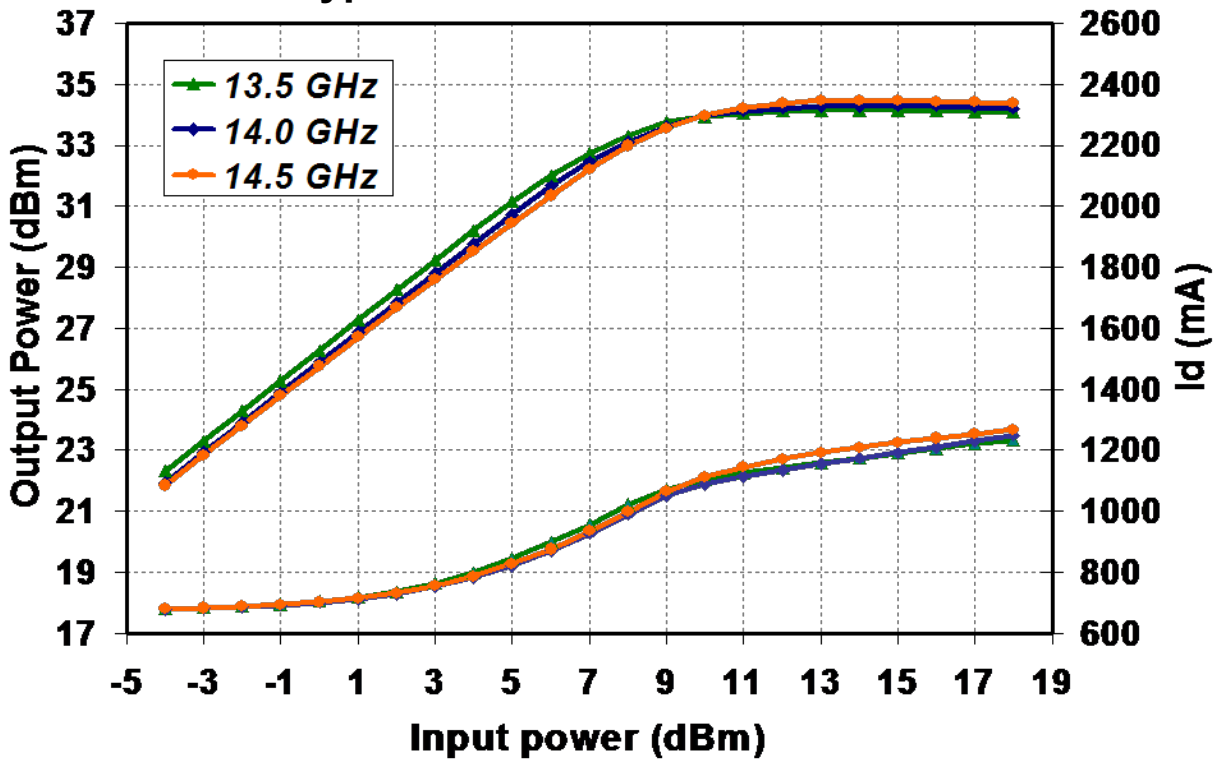

Typical Fixtured Performance

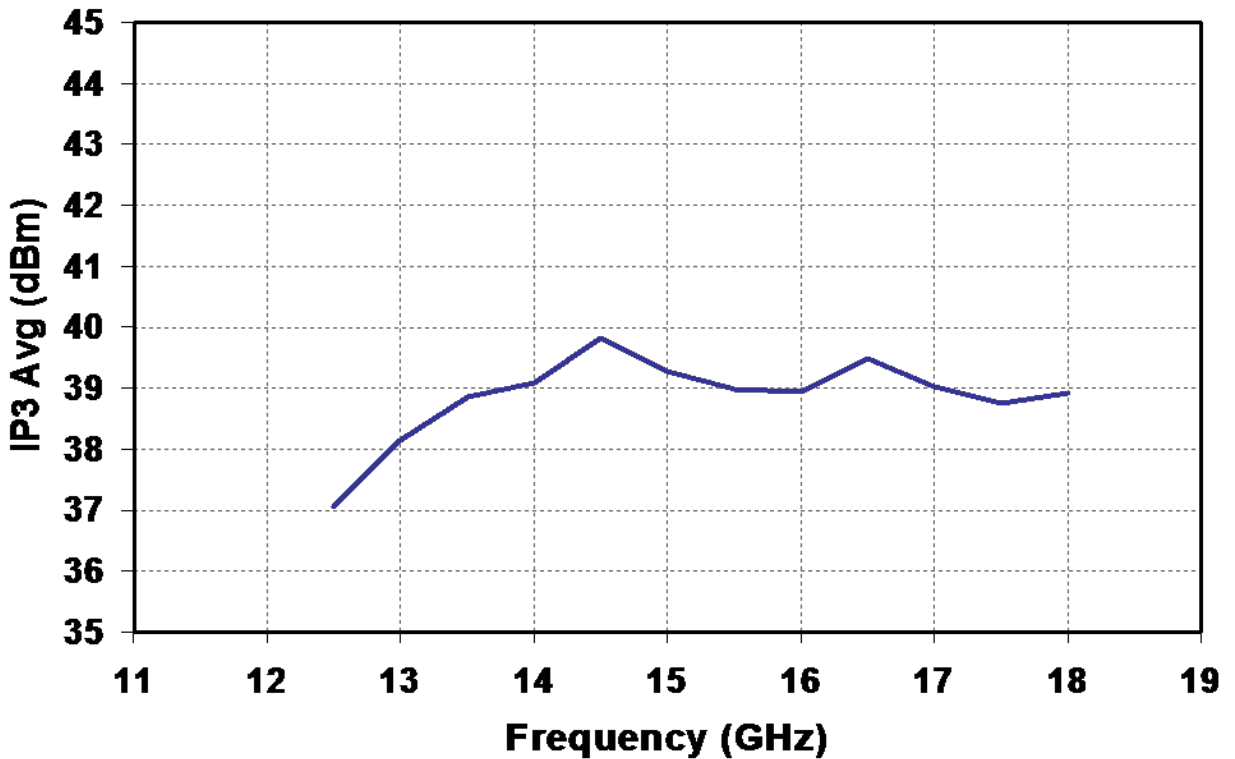
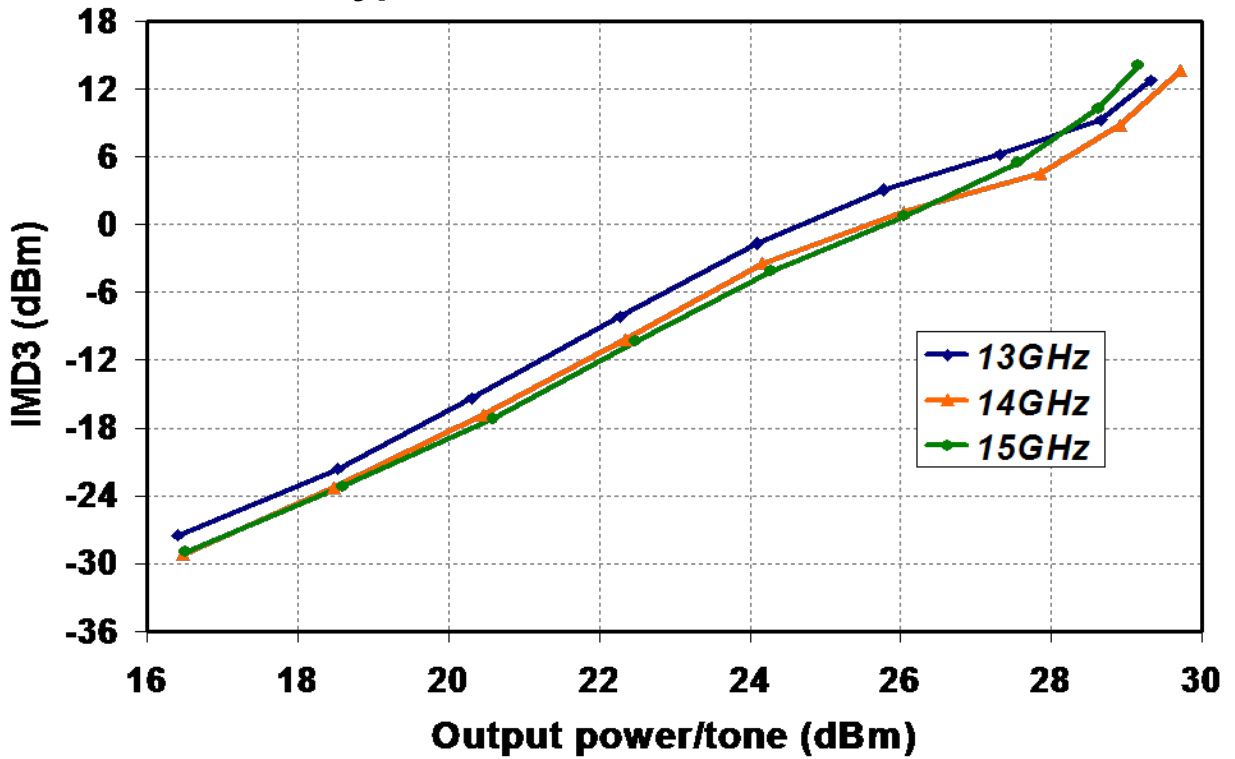

Mechanical Drawing

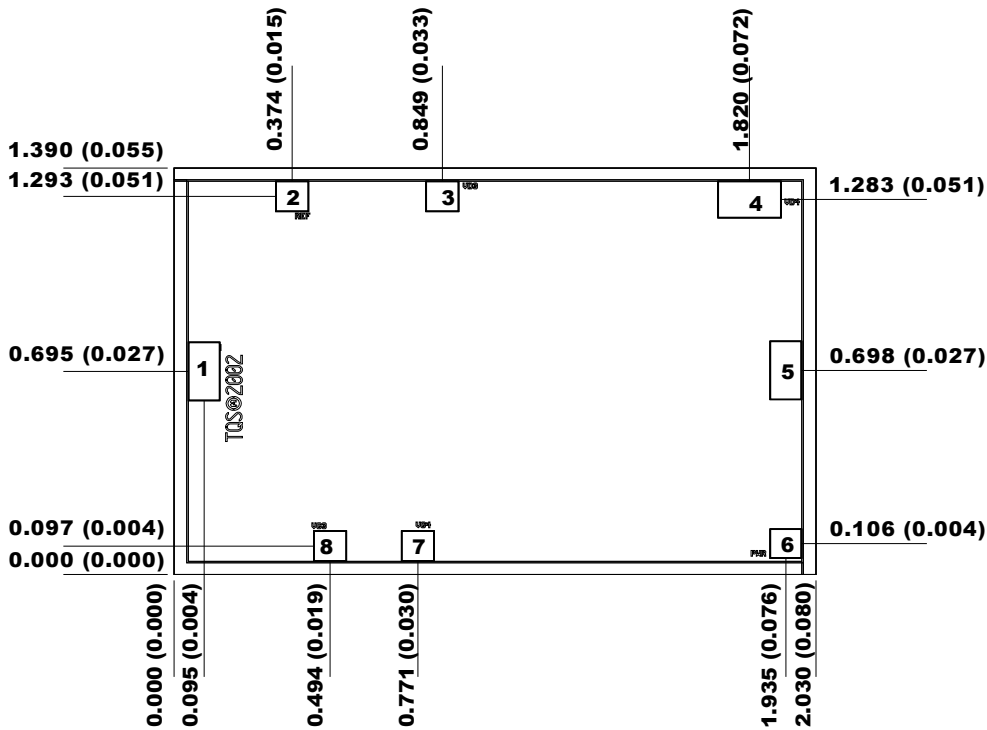

Units: millimeters (inches)

Thickness: 0.100 (0.004)

Chip edge to bond pad dimensions are shown to center of bond pad

Chip size tolerance: +/- 0.051 (0.002)

GND IS BACKSIDE OF MMIC

Bond pad #1	(RF Input)	0.100 x 0.200 (0.004 x 0.008)
Bond pad #2	(Vref)	0.100 x 0.100 (0.004 x 0.004)
Bond pad #3	(Vd3)	0.100 x 0.100 (0.004 x 0.004)
Bond pad #4	(Vd4)	0.200 x 0.125 (0.008 x 0.005)
Bond pad #5	(RF Output)	0.100 x 0.200 (0.004 x 0.008)
Bond pad #6	(Vdet)	0.100 x 0.100 (0.004 x 0.004)
Bond pad #7	(Vg4)	0.100 x 0.100 (0.004 x 0.004)
Bond pad #8	(Vg3)	0.100 x 0.100 (0.004 x 0.004)

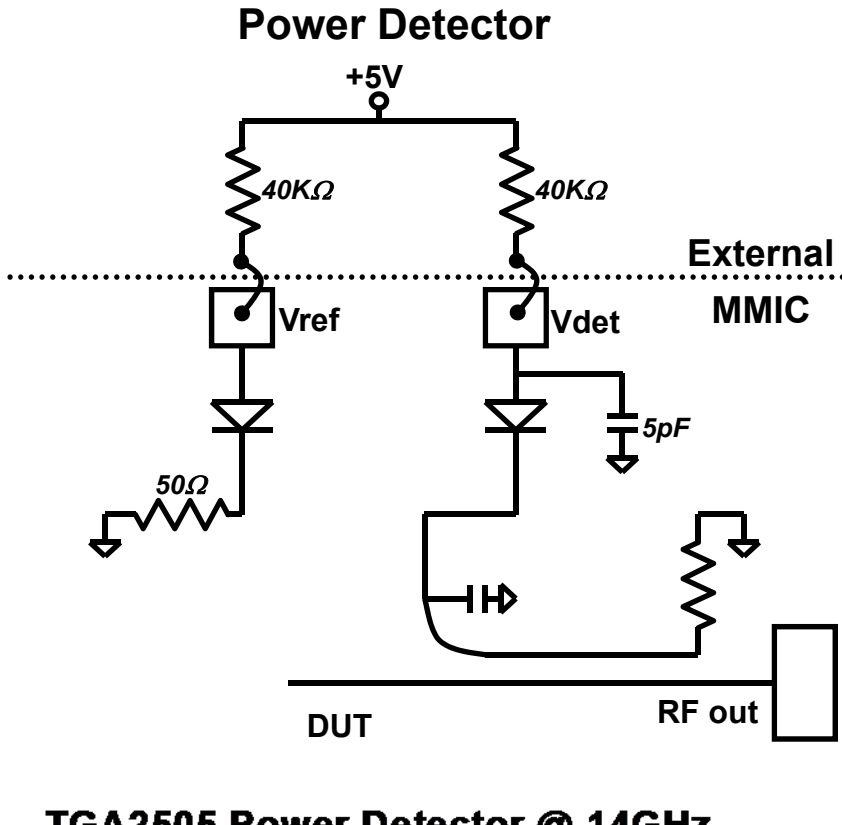

TGA2505 Power Detector @ 14GHz

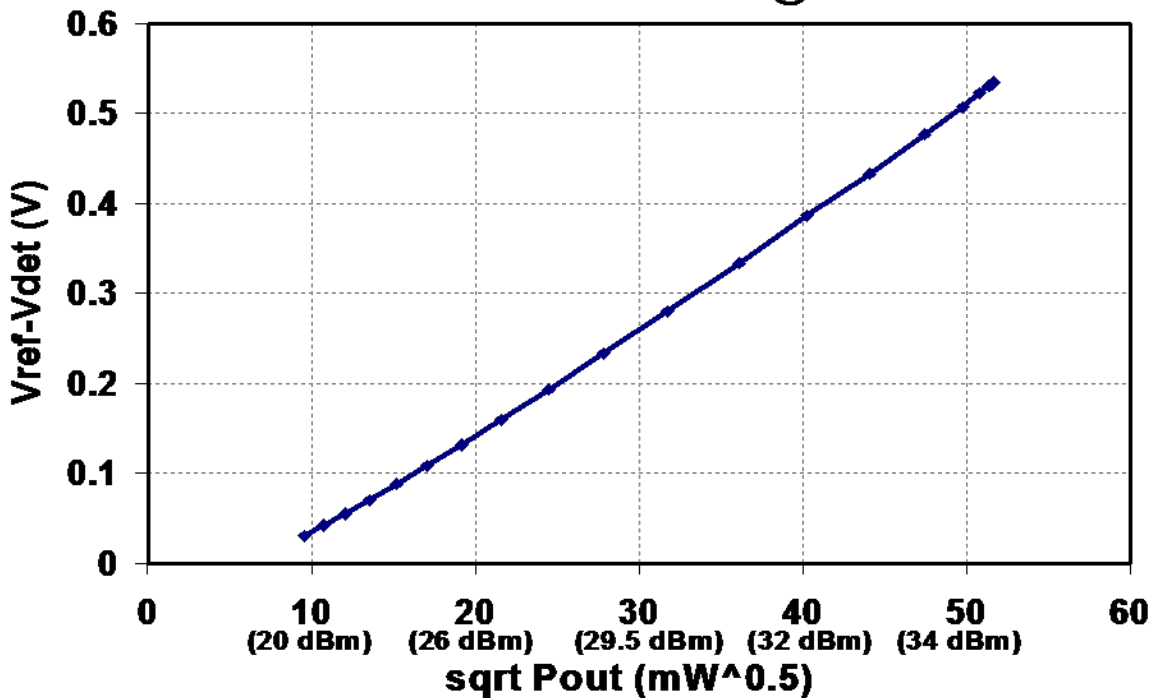

Chip Assembly & Bonding Diagram

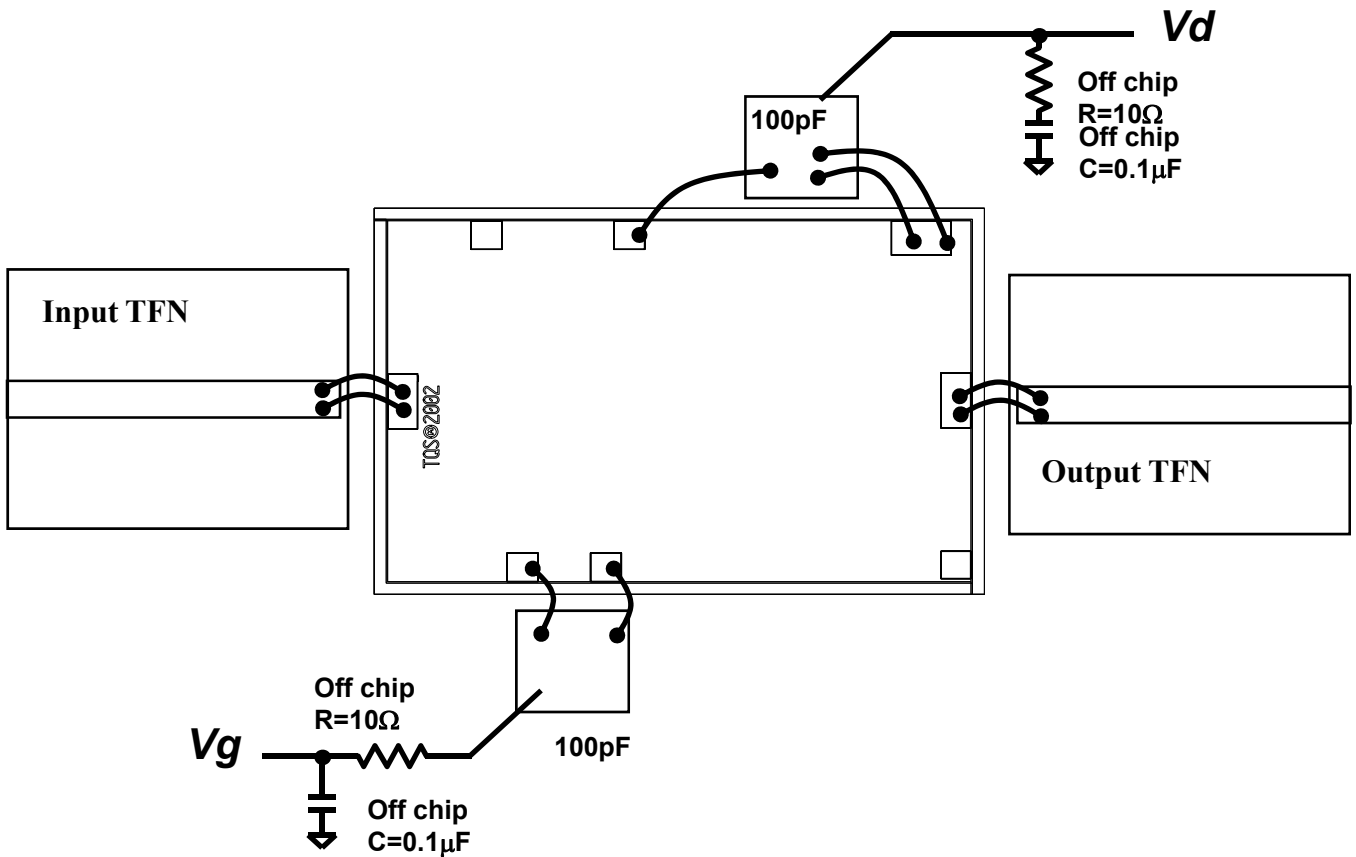

GaAs MMIC devices are susceptible to damage from Electrostatic Discharge. Proper precautions should be observed during handling, assembly and test.

Assembly Process Notes

Reflow process assembly notes:

- Use AuSn (80/20) solder with limited exposure to temperatures at or above 300°C. (30 seconds maximum)
- An alloy station or conveyor furnace with reducing atmosphere should be used.
- No fluxes should be utilized.
- Coefficient of thermal expansion matching is critical for long-term reliability.
- Devices must be stored in a dry nitrogen atmosphere.

Component placement and adhesive attachment assembly notes:

- Vacuum pencils and/or vacuum collets are the preferred method of pick up.
- Air bridges must be avoided during placement.
- The force impact is critical during auto placement.
- Organic attachment can be used in low-power applications.
- Curing should be done in a convection oven; proper exhaust is a safety concern.
- Microwave or radiant curing should not be used because of differential heating.
- Coefficient of thermal expansion matching is critical.

Interconnect process assembly notes:

- Thermosonic ball bonding is the preferred interconnect technique.
- Force, time, and ultrasonics are critical parameters.
- Aluminum wire should not be used.
- Discrete FET devices with small pad sizes should be bonded with 0.0007-inch wire.
- Maximum stage temperature is 200°C.

GaAs MMIC devices are susceptible to damage from Electrostatic Discharge. Proper precautions should be observed during handling, assembly and test.