

MIL-DTL-83513/10 Thru /15 Micro-D Connectors Right Angle PCB Connectors (CBR)

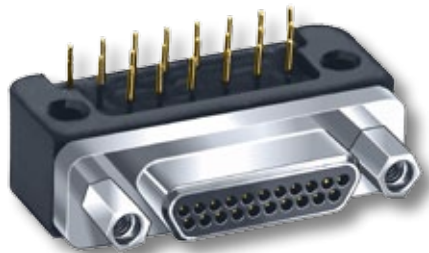

Micro-D
MIL-DTL-83513



High Performance — These connectors feature gold-plated TwistPin contacts for best performance. PC tails are .020 inch diameter. Specify nickel-plated shells or cadmium plated shells for best availability.

Solder-Dipped — Terminals are coated with SN63/Pb37 tin-lead solder for best solderability.

HOW TO ORDER M83513/10 THRU /15 NARROW PROFILE RIGHT ANGLE PCB CONNECGTORS

Spec Number	Slash Number- Shell Size	PC Tail Length	Shell Finish	Hardware Option	
M83513/	Plug (Pin Contacts)		01 - .109 Inch (2.77 mm) 02 - .140 Inch (3.56 mm) 03 - .172 Inch (4.37 mm)	C - Cadmium N - Electroless Nickel P - Passivated SST	N - No Jackpost P - Jackposts Installed T - Threaded Insert in Board Mount Hole (No Jackposts) W - Threaded Insert in Board Mount Hole and jackposts Installed See "Hardware Options" below for Illustrations Shell sizes A (9) through G (51) are #2-56 UNC-2 threads. Shell size H (100) is #4-40 UNC-2 threads.
	10-A - 9 Contacts	PC Tail Length ± .015 (0.38)			
	10-B - 15 Contacts				
	10-C - 21 Contacts				
	10-D - 25 Contacts				
	10-E - 31 Contacts				
	10-F - 37 Contacts				
	11-G - 51 Contacts				
	12-H - 100 Contacts				
	Receptacle (Socket Contacts)				
	13-A - 9 Contacts				
	13-B - 15 Contacts				
	13-C - 21 Contacts				
	13-D - 25 Contacts				
	13-E - 31 Contacts				
	13-F - 37 Contacts				
	14-G - 51 Contacts				
15-H - 100 Contacts					
Sample Part Number					
M83513/	13-B	02	N	P	



HARDWARE OPTIONS

N	P	T	W
THRU HOLE	THRU HOLE	2X THREADED INSERTS	2X THREADED INSERTS
No Jackpost	Jackpost	Threaded Insert	Jackpost, Threaded Insert



MIL-DTL-83513/10 Thru /15 Micro-D Connectors Right Angle PCB Connectors (CBR)

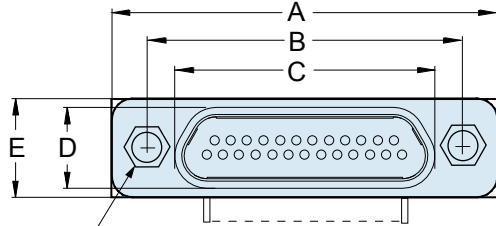

9-51 CONTACTS #2-56 UNC-2B THREADS
100 CONTACTS #4-40 UNC-2B THREADS

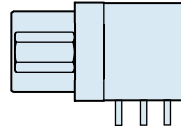

THREAD SIZES
9-51 CONTACTS #2-56 UNC
100 CONTACTS #4-40 UNC

CONFIGURATION FOR 9-25 CONTACTS

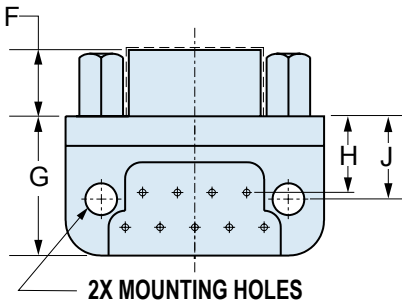

2X MOUNTING HOLES
PCB MOUNTING HOLES
9-51 CONTACTS .096 DIA. ± .003 (2.44 ± 0.08)
100 CONTACTS .125 DIA. ± .003 (3.18 ± 0.08)

CONFIGURATION FOR 31-100 CONTACTS

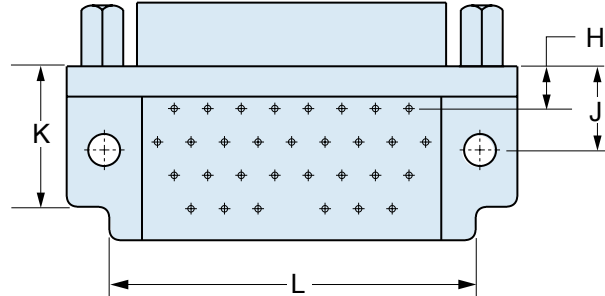

DIMENSIONS

Layout	A Max.		B		C Max.		D Max.		E Max.		F		G Max.		H		J		K Max.		L Max.	
	In.	mm.	In. ±.003	mm. ±0.08	In.	mm.	In.	mm.	In.	mm.	In. ±.003	mm. ±0.08	In.	mm.	In. ±.010	mm. ±0.25	In. ±.010	mm. ±0.25	In.	mm.	In.	mm.
9P	.787	19.94	.565	14.35	.333	8.46	.184	4.67	.310	7.87	.183	4.65	.425	10.80	.230	5.84	.250	6.35	—	—	—	—
9S	.787	19.94	.565	14.35	.400	10.16	.250	6.35	.310	7.87	.195	4.95	.425	10.80	.230	5.84	.250	6.35	—	—	—	—
15P	.937	23.75	.715	18.16	.483	12.27	.184	4.67	.310	7.87	.183	4.65	.425	10.80	.130	3.30	.250	6.35	—	—	—	—
15S	.937	23.75	.715	18.16	.551	14.00	.250	6.35	.310	7.87	.195	4.95	.425	10.80	.130	3.30	.250	6.35	—	—	—	—
21P	1.087	27.56	.865	21.97	.633	16.08	.184	4.67	.310	7.87	.183	4.65	.425	10.80	.130	3.30	.250	6.35	—	—	—	—
21S	1.087	27.56	.865	21.97	.701	17.81	.250	6.35	.310	7.87	.195	4.95	.425	10.80	.130	3.30	.250	6.35	—	—	—	—
25P	1.187	30.01	.965	24.51	.733	18.62	.184	4.67	.310	7.87	.183	4.65	.425	10.80	.130	3.30	.250	6.35	—	—	—	—
25S	1.187	30.01	.965	24.51	.801	20.35	.250	6.35	.310	7.87	.195	4.95	.425	10.80	.130	3.30	.250	6.35	—	—	—	—
31P	1.337	33.91	1.115	28.32	.883	22.43	.184	4.67	.310	7.87	.183	4.65	.525	13.34	.130	3.30	.250	6.35	.450	11.43	1.085	27.56
31S	1.337	33.91	1.115	28.32	.951	24.16	.250	6.35	.310	7.87	.195	4.95	.525	13.34	.130	3.30	.250	6.35	.450	11.43	1.085	27.56
37P	1.487	37.72	1.265	32.13	1.033	26.24	.184	4.67	.310	7.87	.183	4.65	.525	13.34	.130	3.30	.250	6.35	.450	11.43	1.185	30.10
37S	1.487	37.72	1.265	32.13	1.101	27.96	.250	6.35	.310	7.87	.195	4.95	.525	13.34	.130	3.30	.250	6.35	.450	11.43	1.185	30.10
51P	1.435	36.45	1.215	30.86	.983	24.97	.228	5.79	.351	8.92	.183	4.65	.660	16.76	.150	3.81	.300	7.62	.450	11.43	1.225	31.12
51S	1.435	36.45	1.215	30.86	1.051	26.70	.296	7.52	.351	8.92	.195	4.95	.660	16.76	.150	3.81	.300	7.62	.450	11.43	1.225	31.12
100P	2.175	55.12	1.800	45.72	1.383	35.13	.270	6.86	.394	10.01	.183	4.65	1.010	25.65	.200	5.08	.400	10.16	.590	14.99	1.820	46.23
100S	2.175	55.12	1.800	45.72	1.451	36.86	.333	8.46	.394	10.01	.195	4.95	1.010	25.65	.200	5.08	.400	10.16	.590	14.99	1.820	46.23

M83513/10 THRU /12 CONNECTOR PCB LAYOUTS – PIN CONNECTORS

Patterns shown are for connector mounting side of PC board. 9 Thru 51 Contacts .096 (2.44) Diameter Mounting Holes, 100 Pin .125 (3.18) Diameter

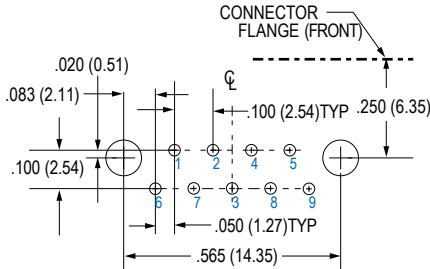

9 PIN M83513/10-A

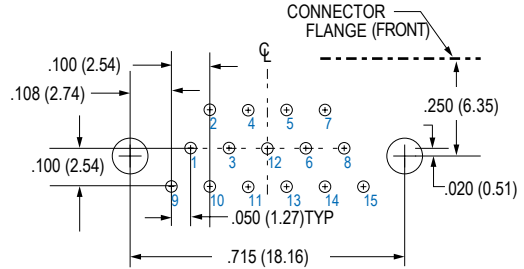

15 PIN M83513/10-B

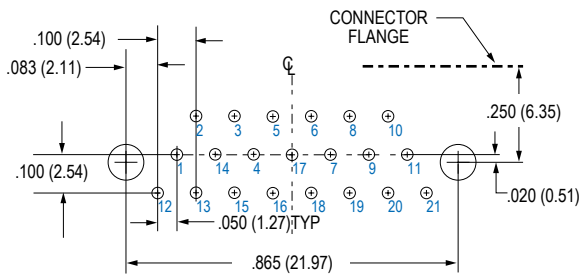

21 PIN M83513/10-C

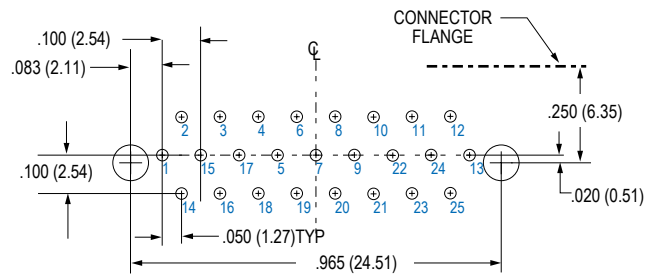

25 PIN M83513/10-D

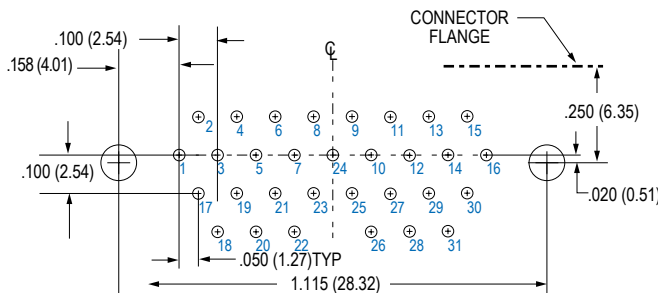

31 PIN M83513/10-E

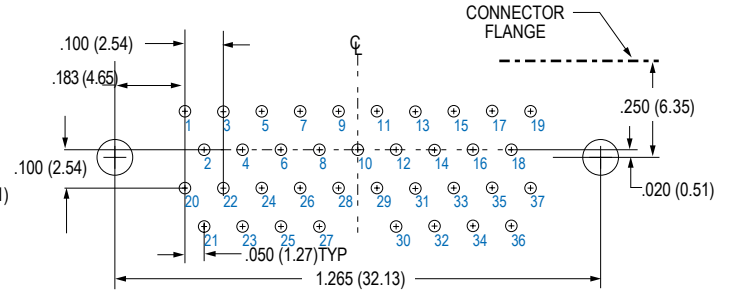

37 PIN M83513/10-F

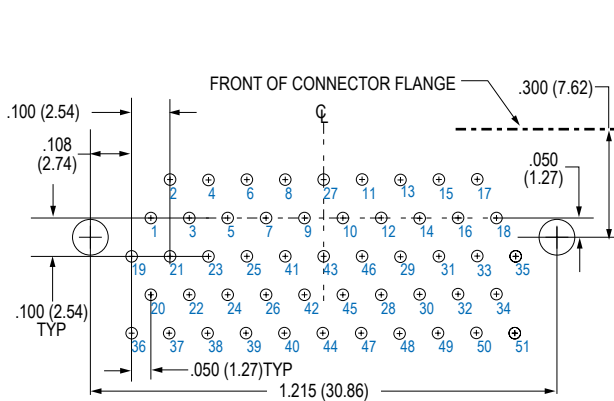

51 PIN M83513/11-G

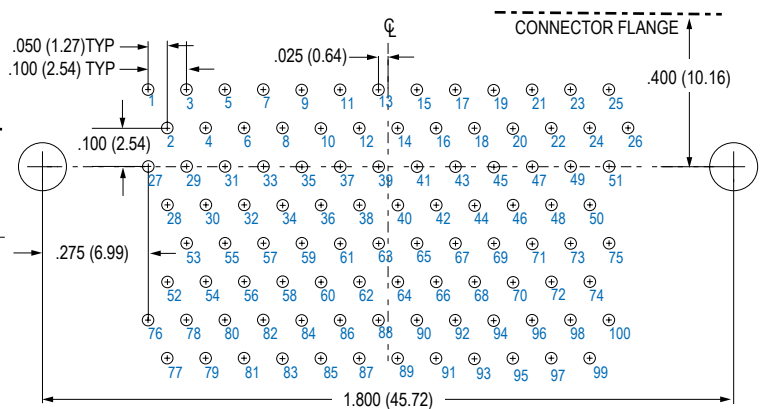

100 PIN M83513/12-H



MIL-DTL-83513/10 Thru /15 Micro-D Connectors Right Angle PCB Connectors (CBR)

M83513/13 THRU /15 CONNECTOR PCB LAYOUTS – SOCKET CONNECTORS

Patterns shown are for connector mounting side of PC board. 9 Thru 51 Contacts .096 (2.44) Diameter Mounting Holes, 100 Pin .125 (3.18) Diameter

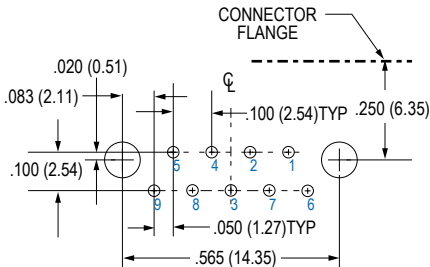

9 SOCKET M83513/13-A

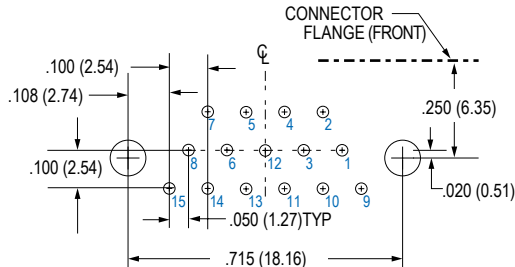

15 SOCKET M83513/13-B

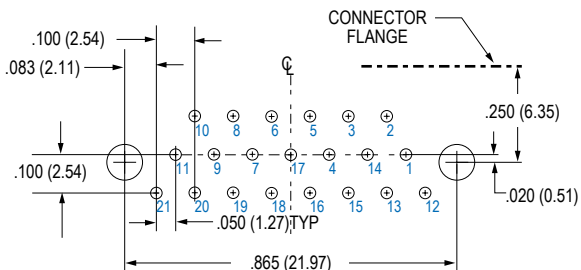

21 SOCKET M83513/13-C

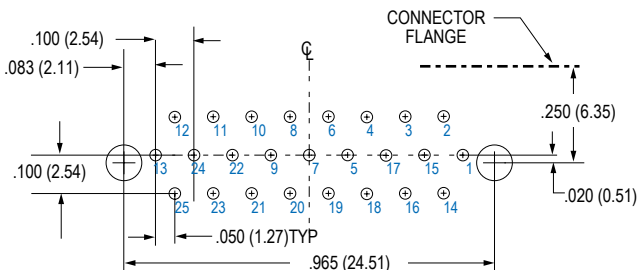

25 SOCKET M83513/13-D

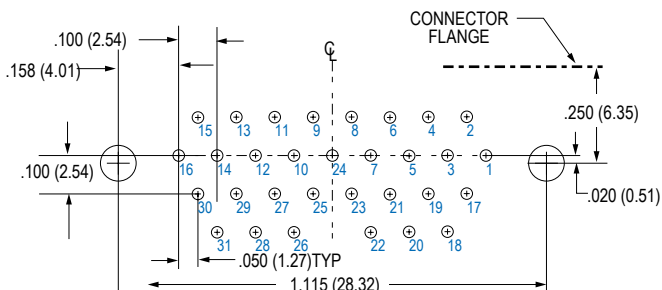

31 SOCKET M83513/13-E

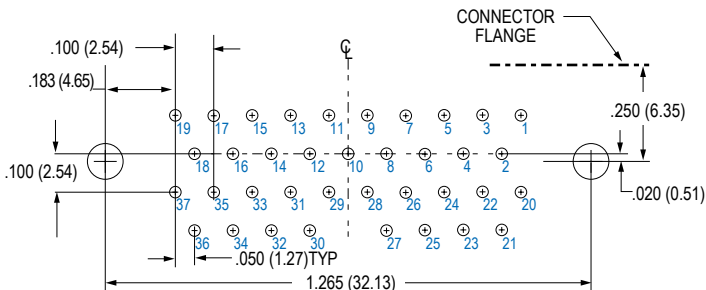

37 SOCKET M83513/13-F

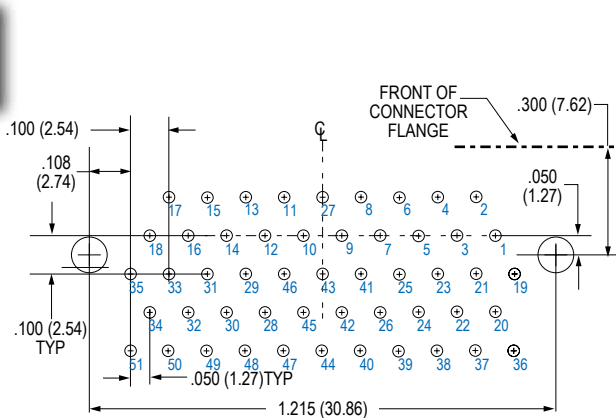

51 SOCKET M83513/14-G

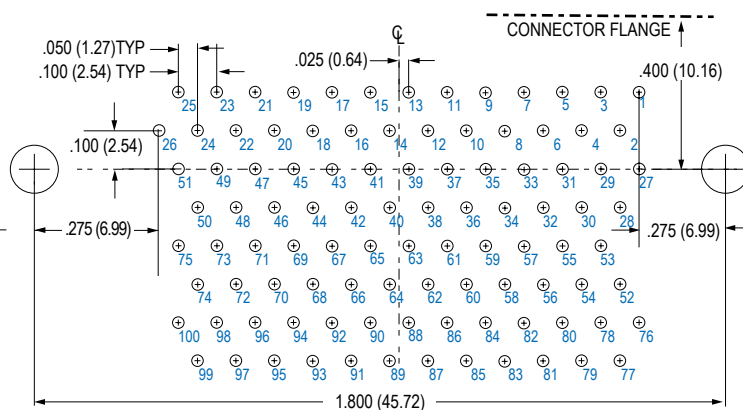

100 SOCKET M83513/15-H