

IL494A

Pulse-Width-Modulation Control Circuit

The IL494A is a fixed frequency, pulse width modulation control circuit designed primarily for SWITCH MODE power supply control.

- Complete Pulse Width Modulation Control Circuitry
- On-Chip Oscillator with Master or Slave Operation
- On-Chip Error Amplifiers
- On-Chip 5.0 V Reference
- Adjustable Deadtime Control
- Uncommitted Output Transistors Rated to 500 mA Source or Sink
- Output Control for Push-Pull or Single-Ended Operation
- Undervoltage Lockout

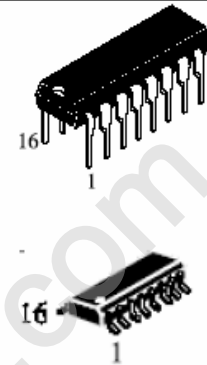

ORDERING INFORMATION

IL494AN 16-DIP

IL494AD 16-SOP

$T_A = -20^{\circ}\text{C}$ to 85°C

for all packages

LOGIC DIAGRAM

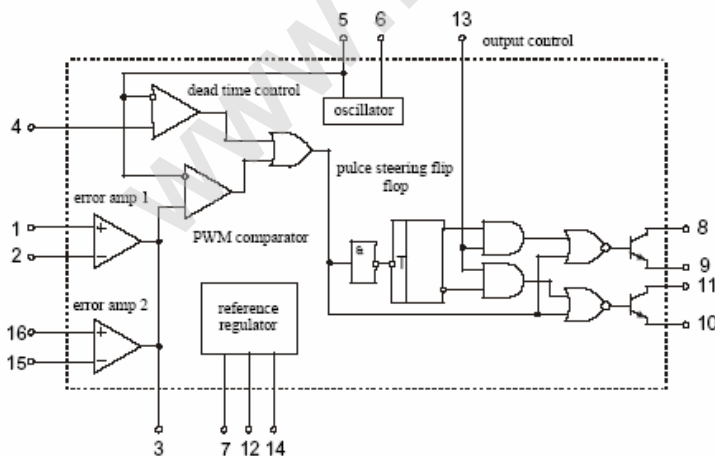

Pin 7 = GND
Pin 12 = V_{CC}

PIN ASSIGNMEN

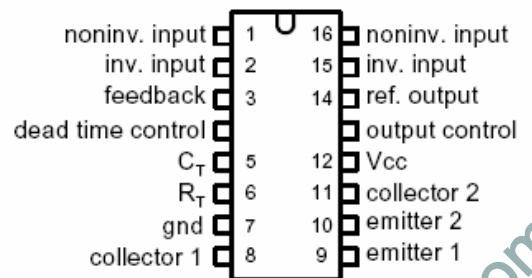

MAXIMUM RATINGS

Symbol	Parameter	Value	Unit
V_{CC}	Supply Voltage	41	V
V_I	Amplifier Input Voltage	$V_{CC} + 0.3$	V
V_O	Collector Output Voltage	41	V
	Collector Output Current	250	mA
Tstg	Storage Temperature	-65 to +150	°C

RECOMMENDED OPERATING CONDITIONS

Symbol	Parameter	Min	Max	Unit
V_{CC}	Supply Voltage	7	40	V
V_I	Amplifier Input Voltage	-0.3	$V_{CC} - 2$	V
V_O	Collector Output Voltage		40	V
	Collector Output Current (Each Transistor)		200	mA
	Current Into Feed back Terminal		0.3	mA
C_T	Timing Capacitor	0.47	10.000	nF
R_T	Timing Resistor	1.8	500	K Ω
	Oscillator Frequency	1	300	KHz
T_A	Operating Free-Air Temperature	-20	+85	°C

ELECTRICAL CHARACTERISTICS(Temperature -20 ~ 85°C, $V_{CC} = 15\text{ V}$, $f=10\text{ kHz}$)

Symbol	Parameter	Test Conditions	Value		Temperature, °C	Unit
			Min	Max		
V_{ref}	Output voltage	$I_0=1.0\text{mA}$ $V_{CC}=15\text{V}$	4.90	5.10	-20~+85	V
V_{regin}	Input regulation	$V_{CC}=7\div 40\text{V}$ $I_0=1.0\text{mA}$	-	25	25	mV
V_{regout}	Output regulation	$I_0=1\div 10\text{ mA}$ $V_{CC}=15\text{ V}$	-	15	25	mV
ΔV_{ref}	Output voltage change with temperature	$I_0=1\text{ mA}$ $V_{CC}=15\text{ V}$	-	1.0	-20~+85	%
I_{SC}	Short circuit output current	$V_{ref}=0$, $t_{sc}< 1\text{ s}$ $V_{CC}=15\text{ V}$	-	50		mA
f_{osc}	Frequency	$C=0.01\mu\text{F}$, $R=12\text{k}\Omega$ $V_{CC}=15\text{ V}$ $V_{(03)}=0.7\text{ V}$	6.0	14		kHz
$\sigma_{f_{osc}}$	Standard Deviation of Frequency *	$V_{CC}=15\text{ V}$ $V_{(03)}=0.7\text{ V}$	-	15		%
$\sigma_{f_{osc}(\Delta V)}$	Frequency Change with Voltage	$V_{CC}=7\div 40\text{ V}$ $V_{(03)}=0.7\text{ V}$	-	10	25	%
$\sigma_{f_{osc}(\Delta T)}$	Frequency Change with Temperature	$C=0.01\mu\text{F}$, $R_T=12\text{ k}\Omega$ $V_{CC}=15\text{ V}$ $V_{(03)}=0.7\text{ V}$	-	2.0	-20~+85	%
$I_{IB(2T)}$	Input bias current (pin 4)	$V_I=0\div 5.25\text{V}$ $V_{CC}=15\text{ V}$ $V_{(03)}=0.7\text{ V}$	-	-10		μA
DCmax	Maximum duty cycle (each output)	$V_{I(04)}=0\text{V}$ $V_{CC}=15\text{ V}$ $V_{(03)}=0.7\text{ V}$	45	-		%
V_{THD1}	Input threshold voltage (pin 4) (Zero Duty Cycle)	DCmax=0 $V_{CC}=15\text{ V}$ $V_{(03)}=0.7\text{ V}$	-	3,3		V
V_{THD2}	Input threshold voltage (pin 4) (Maximum Duty Cycle)	DCmax $V_{CC}=15\text{ V}$ $V_{(03)}=0.7\text{ V}$	0	-		V
t_{re}	Output voltage rise time (Common-Emitter)	$V_{CC}=15\text{ V}$ $V_{(03)}=2.0\text{ V}$	-	200	-20~+85	ns
t_{fe}	Output voltage fall time (Common-Emitter)	$V_{CC}=15\text{ V}$ $V_{(03)}=2.0\text{ V}$	-	100		ns
t_{rf}	Output voltage rise time (Emitter-Follower)	$V_{CC}=V_C=15\text{ V}$ $V_{(03)}=2.0\text{ V}$	-	200		ns
t_{ff}	Output voltage fall time (Emitter-Follower)	$V_{CC}=V_C=15\text{ V}$ $V_{(03)}=2.0\text{ V}$	-	100	-20~+85	ns

ELECTRICAL CHARACTERISTICS(Temperature -20 ~ 85°C, V_{CC} = 15 V, f=10 kHz)

Symbol	Parameter	Test Conditions	Value		Temperature, °C	Unit
			Min	Max		
V _{THP}	Input threshold voltage (pin 3)	DCmax=0 V _{CC} =15 V	-	4.5	-20~+85	V
I _I	Input sink current (pin 3)	V _{CC} = 15 V V _{O(03)} = 0.7 V	0.3	-		mA
V _{IO}	Input offset voltage	V _{CC} = 15 V V _{O(03)} = 2.5 V	-	10		mV
I _{IO}	Input offset current	V _{CC} = 15 V V _{O(03)} = 2.5 V	-	250		nA
I _{IB}	Input bias current	V _{CC} = 15 V V _{O(03)} = 2.5 V	-	1		μA
V _{ICRL}	Low Input common mode voltage range	V _{CC} = 7~40 V	-0.3	-		V
V _{ICRH}	High Input common mode voltage range	V _{CC} = 7~40 V	V _{CC} -2	-		V
A _{VOL}	Open loop voltage amplification	ΔV _O =3 V V _{CC} = 15 V V _O = 0.5~ 3.5 V	70	-		dB
f _b	Unity-gain bandwidth	V _{CC} = 15 V	100	-		kHz
CMRR	Common mode rejection ratio	V _{CC} =40 V	65	-		25
I _{OL}	Output sink current (pin 3)	V _{CC} = 15 V V _{O(03)} = 0.7 V	0.3	-	-20~+85	mA
I _{OH}	Output source current (pin 3)	V _{CC} = 15 V V _{O(03)} = 3.5 V	-2.0	-		mA
I _{C(off)}	Collector off-state current	V _{CE} = V _{CC} = 40 V	-	100		μA
I _{E(off)}	Emitter off-state current	V _{CC} = V _C = 40 V V _E = 0 V	-	-100		μA
V _{SAT(C)}	Collector - Emitter saturation voltage (Common-Emitter)	V _{CC} = 15 V V _E = 0 V V _{O(03)} = 3.0 V I _C = 200 mA	-	1.3		V
V _{SAT(E)}	Collector - Emitter saturation voltage (Emitter-follower)	V _{CC} =V _C = 15 V I _E = - 200 mA V _{O(03)} = 3.0 V	-	2.5	25	V
			-	2.9	-20~+85	
I _{OCH}	Output control input current	V _{CC} = 15 V V _{O(03)} = 0.7 V	-	3.5	25	mA
I _{CC15}	Standby Supply Current at V _{CC} 15V	V _{CC} = 15 V	-	10		mA
I _{CC40}	Standby Supply Current at V _{CC} 40V	V _{CC} = 40 V	-	15		mA
I _{CCA}	Average Supply Current	V _{CC} = 15 V V _{O(03)} = 0.7 V V _{O(04)} = 2.0 V	-	17	-20~+85	mA

* - Standard deviation is a measure of the statistical distribution about the mean as derived from the

$$\text{formula } \sigma = \sqrt{\frac{\sum_{n=1}^N (X_n - \bar{X})^2}{N - 1}}$$

**N SUFFIX PLASTIC DIP
(MS - 001BB)**

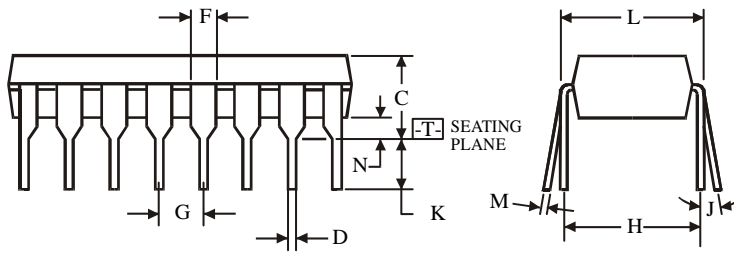
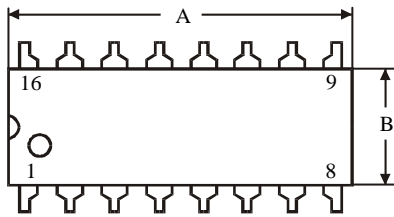
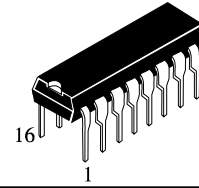

$\oplus 0.25 (0.010) \text{ (M) T}$

NOTES:

- Dimensions "A", "B" do not include mold flash or protrusions.
Maximum mold flash or protrusions 0.25 mm (0.010) per side.

Symbol	Dimension, mm	
	MIN	MAX
A	18.67	19.69
B	6.1	7.11
C		5.33
D	0.36	0.56
F	1.14	1.78
G	2.54	
H	7.62	
J	0°	10°
K	2.92	3.81
L	7.62	8.26
M	0.2	0.36
N	0.38	

**D SUFFIX SOIC
(MS - 012AC)**

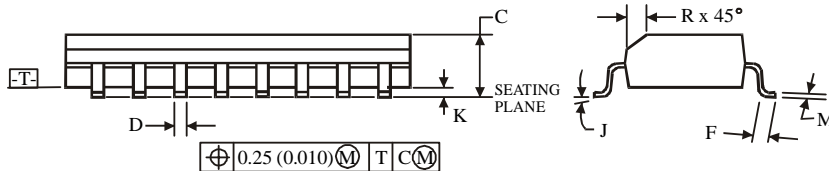
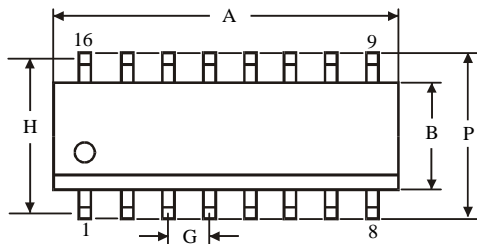
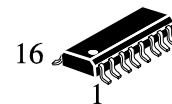

$\oplus 0.25 (0.010) \text{ (M) T C (M)}$

NOTES:

- Dimensions A and B do not include mold flash or protrusion.
- Maximum mold flash or protrusion 0.15 mm (0.006) per side for A; for B - 0.25 mm (0.010) per side.

Symbol	Dimension, mm	
	MIN	MAX
A	9.8	10
B	3.8	4
C	1.35	1.75
D	0.33	0.51
F	0.4	1.27
G	1.27	
H	5.72	
J	0°	8°
K	0.1	0.25
M	0.19	0.25
P	5.8	6.2
R	0.25	0.5