

Features

- Epitaxial Planar Die Construction
- Complementary NPN Types Available (DDTC)
- Built-In Biasing Resistors, R1≠R2
- Also Available in Lead Free Version

Mechanical Data

- Case: SC-59, Molded Plastic
- Case material - UL Flammability Rating 94V-0
- Moisture sensitivity: Level 1 per J-STD-020A
- Terminals: Solderable per MIL-STD-202, Method 208
- Also Available in Lead Free Plating (Matte Tin Finish). Please see Ordering Information, Note 3, on Page 2
- Terminal Connections: See Diagram
- Marking: Date Code and Marking Code (See Diagrams & Page 3)
- Weight: 0.008 grams (approx.)
- Ordering Information (See Page 2)

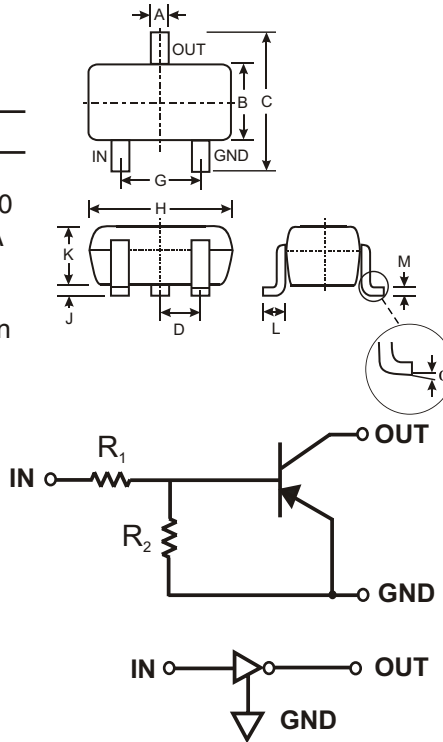

SC-59		
Dim	Min	Max
A	0.35	0.50
B	1.50	1.70
C	2.70	3.00
D	0.95	
G	1.90	
H	2.90	3.10
J	0.013	0.10
K	1.00	1.30
L	0.35	0.55
M	0.10	0.20
α	0°	8°
All Dimensions in mm		

P/N	R1 (NOM)	R2 (NOM)	MARKING
DDTA113ZKA	1KΩ	10KΩ	P02
DDTA123YKA	2.2KΩ	10KΩ	P05
DDTA123JKA	2.2KΩ	47KΩ	P06
DDTA143XKA	4.7KΩ	10KΩ	P09
DDTA143FKA	4.7KΩ	22KΩ	P10
DDTA143ZKA	4.7KΩ	47KΩ	P11
DDTA114YKA	10KΩ	47KΩ	P14
DDTA114WKA	10KΩ	4.7KΩ	P15
DDTA124XKA	22KΩ	47KΩ	P18
DDTA144VKA	47KΩ	10KΩ	P21
DDTA144WKA	47KΩ	22KΩ	P22

SCHMATIC DIAGRAM

Maximum Ratings @ T_A = 25°C unless otherwise specified

Characteristic	Symbol	Value	Unit
Supply Voltage, (3) to (1)	V _{CC}	-50	V
Input Voltage, (2) to (1)	V _{IN}	+5 to -10 +5 to -12 +5 to -12 +7 to -20 +6 to -30 +5 to -30 +6 to -40 +10 to -30 +10 to -40 +15 to -40 +10 to -40	V
Output Current	I _O	-100 -100 -100 -100 -100 -100 -100 -70 -100 -50 -30 -30	mA
Output Current	I _C (Max)	-100	mA
Power Dissipation	P _d	200	mW
Thermal Resistance, Junction to Ambient Air (Note 1)	R _{θJA}	625	°C/W
Operating and Storage and Temperature Range	T _j , T _{STG}	-55 to +150	°C

Note: 1. Mounted on FR4 PC Board with recommended pad layout at <http://www.diodes.com/datasheets/ap02001.pdf>.

Electrical Characteristics @ T_A = 25°C unless otherwise specified

Characteristic		Symbol	Min	Typ	Max	Unit	Test Condition	
Input Voltage	DDTA113ZKA DDTA123YKA DDTA123JKA DDTA143XKA DDTA143FKA DDTA143ZKA DDTA114YKA DDTA114WKA DDTA124XKA DDTA144VKA DDTA144WKA	V _{I(off)}	-0.3 -0.3 -0.5 -0.3 -0.3 -0.5 -0.3 -0.8 -0.4 -1.0 -0.8	—	—		V	V _{CC} = 5V, I _O = 100μA
	DDTA113ZKA DDTA123YKA DDTA123JKA DDTA143XKA DDTA143FKA DDTA143ZKA DDTA114YKA DDTA114WKA DDTA124XKA DDTA144VKA DDTA144WKA	V _{I(on)}	—	—	-3.0 -3.0 -1.1 -2.5 -1.3 -1.3 -1.4 -3.0 -2.5 -5.0 -4.0		V	V _O = -0.3V, I _O = -20mA V _O = -0.3V, I _O = -20mA V _O = -0.3V, I _O = -5mA V _O = -0.3V, I _O = -20mA V _O = -0.3V, I _O = -3mA V _O = -0.3V, I _O = -5mA V _O = -0.3V, I _O = -1mA V _O = -0.3V, I _O = -2mA V _O = -0.3V, I _O = -2mA V _O = -0.3V, I _O = -2mA V _O = -0.3V, I _O = -2mA
Output Voltage		V _{O(on)}	—	-0.1	-0.3	V	I _O /I _I = -5mA/-0.25mA DDTA123JKA I _O /I _I = -5mA/-0.25mA DDTA143ZKA I _O /I _I = -5mA/-0.25mA DDTA114YKA I _O /I _I = -10mA/-0.5mA All Others	
Input Current	DDTA113ZKA DDTA123YKA DDTA123JKA DDTA143XKA DDTA143FKA DDTA143ZKA DDTA114YKA DDTA114WKA DDTA124XKA DDTA144VKA DDTA144WKA	I _I	—	—	-7.2 -3.8 -3.6 -1.8 -1.8 -1.8 -0.88 -0.88 -0.36 -0.16 -0.16	mA	V _I = -5V	
Output Current		I _{O(off)}	—	—	-0.5	μA	V _{CC} = -50V, V _I = 0V	
DC Current Gain	DDTA113ZKA DDTA123YKA DDTA123JKA DDTA143XKA DDTA143FKA DDTA143ZKA DDTA114YKA DDTA114WKA DDTA124XKA DDTA144VKA DDTA144WKA	G _I	-33 -33 -80 -30 -68 -80 -68 -24 -68 -33 -56	—	—		V _O = -5V, I _O = -10mA	
Input Resistor Tolerance		ΔR ₁	-30	—	+30	%	—	
Resistance Ratio Tolerance		ΔR ₂ /R ₁	-20	—	+20	%	—	
Gain-Bandwidth Product*		f _T	—	250	—	MHz	V _{CE} = -10V, I _E = 5mA, f = 100MHz	

* Transistor - For Reference Only

Ordering Information (Note 2)

Device	Packaging	Shipping
DDTA113ZKA-7	SC-59	3000/Tape & Reel
DDTA123YKA-7	SC-59	3000/Tape & Reel
DDTA123JKA-7	SC-59	3000/Tape & Reel
DDTA143XKA-7	SC-59	3000/Tape & Reel
DDTA143FKA-7	SC-59	3000/Tape & Reel
DDTA143ZKA-7	SC-59	3000/Tape & Reel
DDTA114YKA-7	SC-59	3000/Tape & Reel
DDTA114WKA-7	SC-59	3000/Tape & Reel
DDTA124XKA-7	SC-59	3000/Tape & Reel
DDTA144VKA-7	SC-59	3000/Tape & Reel
DDTA144WKA-7	SC-59	3000/Tape & Reel

Notes: 2. For Packaging Details, go to our website at <http://www.diodes.com/datasheets/ap02007.pdf>.
3. For Lead Free version (with Lead Free terminal finish) part number, please add "-F" suffix to part number above.
Example: DDTA144WKA-7-F.

Marking Information

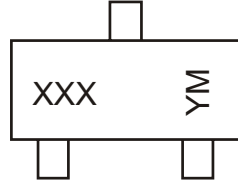

XXX = Product Type Marking Code
 See Sheet 1 Diagrams
 YM = Date Code Marking
 Y = Year ex: N = 2002
 M = Month ex: 9 = September

Date Code Key

Year	2002	2003	2004	2005	2006	2007	2008	2009
Code	N	P	R	S	T	U	V	W

Month	Jan	Feb	March	Apr	May	Jun	Jul	Aug	Sep	Oct	Nov	Dec
Code	1	2	3	4	5	6	7	8	9	O	N	D

TYPICAL CURVES - DDTA123JKA

NEW PRODUCT

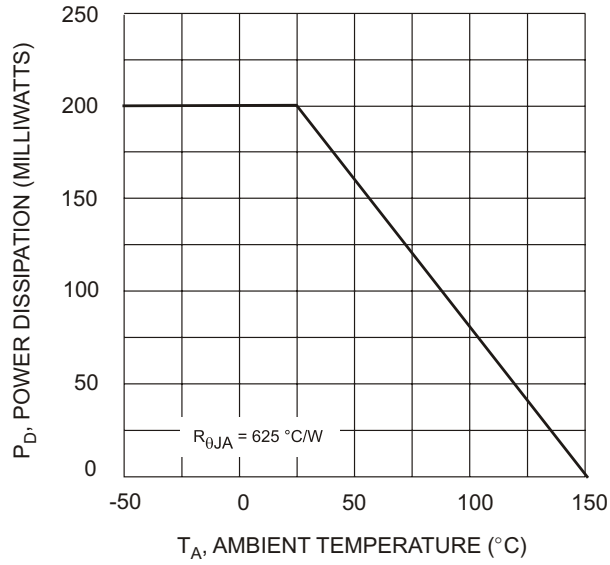

Fig. 1 Derating Curve

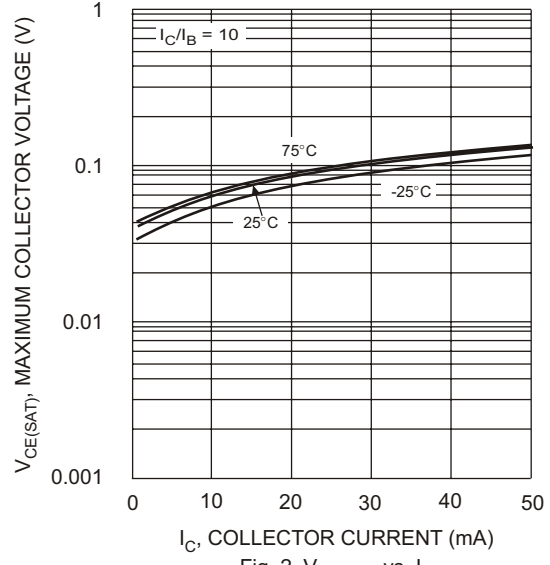

Fig. 2 $V_{CE(SAT)}$ vs. I_C

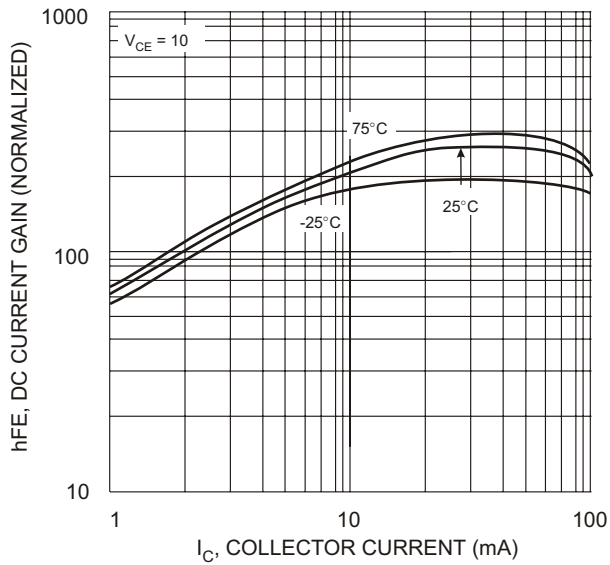

Fig. 3 DC CURRENT GAIN

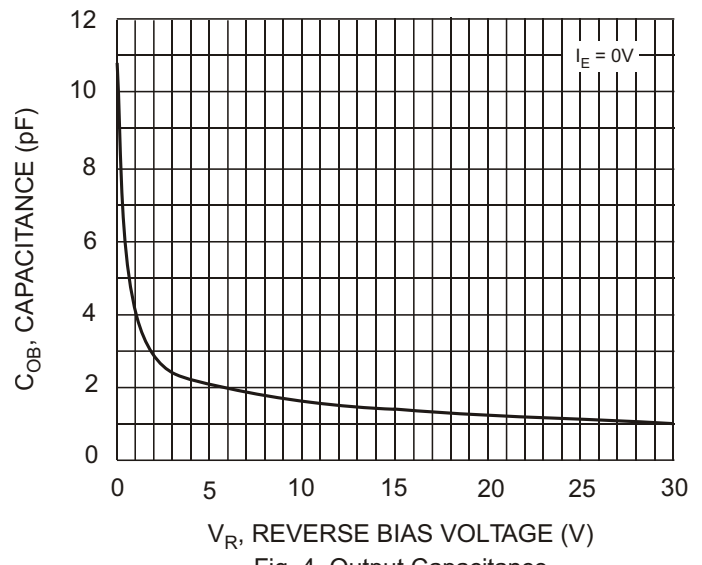

Fig. 4 Output Capacitance

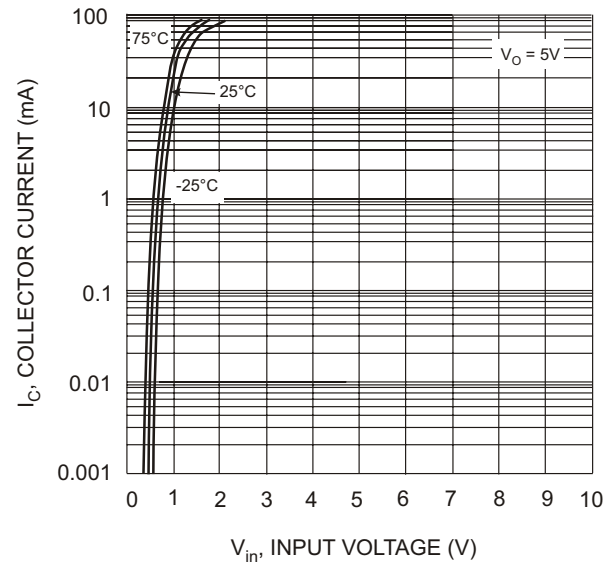

Fig. 5 Collector Current Vs. Input Voltage

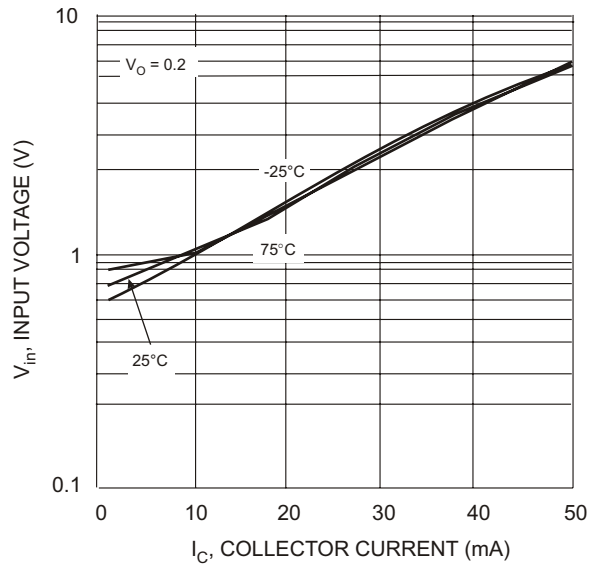

Fig. 6 Input Voltage vs. Collector Current