

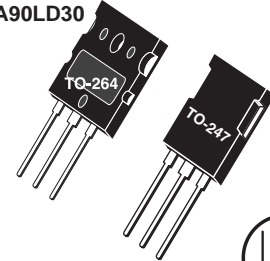
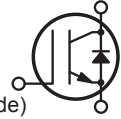

High Speed PT IGBT

POWER MOS 8® is a high speed Punch-Through switch-mode IGBT. Low E_{off} is achieved through leading technology silicon design and lifetime control processes. A reduced $E_{off} - V_{CE(ON)}$ tradeoff results in superior efficiency compared to other IGBT technologies. Low gate charge and a greatly reduced ratio of C_{res}/C_{ies} provide excellent noise immunity, short delay times and simple gate drive. The intrinsic chip gate resistance and capacitance of the poly-silicone gate structure help control di/dt during switching, resulting in low EMI, even when switching at high frequency.

APT64GA90LD30

 APT64GA90B2D30
 Combi (IGBT and Diode)

FEATURES

- Fast switching with low EMI
- Very Low E_{off} for maximum efficiency
- Ultra low C_{res} for improved noise immunity
- Low conduction loss
- Low gate charge
- Increased intrinsic gate resistance for low EMI
- RoHS compliant 

TYPICAL APPLICATIONS

- ZVS phase shifted and other full bridge
- Half bridge
- High power PFC boost
- Welding
- UPS, solar, and other inverters
- High frequency, high efficiency industrial

Absolute Maximum Ratings

Symbol	Parameter	Ratings	Unit
V_{CES}	Collector Emitter Voltage	900	V
I_{C1}	Continuous Collector Current @ $T_c = 25^\circ\text{C}$	117	A
I_{C2}	Continuous Collector Current @ $T_c = 100^\circ\text{C}$	64	
I_{CM}	Pulsed Collector Current ¹	193	
V_{GE}	Gate-Emitter Voltage ²	± 30	V
P_D	Total Power Dissipation @ $T_c = 25^\circ\text{C}$	500	W
SSOA	Switching Safe Operating Area @ $T_J = 150^\circ\text{C}$	193A @ 900V	
T_J, T_{STG}	Operating and Storage Junction Temperature Range	-55 to 150	°C
T_L	Lead Temperature for Soldering: 0.063" from Case for 10 Seconds	300	

Static Characteristics

 $T_J = 25^\circ\text{C}$ unless otherwise specified

Symbol	Parameter	Test Conditions	Min	Typ	Max	Unit
$V_{BR(CES)}$	Collector-Emitter Breakdown Voltage	$V_{GE} = 0V, I_C = 250\mu\text{A}$	900			V
$V_{CE(on)}$	Collector-Emitter On Voltage	$V_{GE} = 15V, I_C = 38A$		2.5 2.2	3.1	
		$T_J = 25^\circ\text{C}$ $T_J = 125^\circ\text{C}$				
$V_{GE(th)}$	Gate Emitter Threshold Voltage	$V_{GE} = V_{CE}, I_C = 1mA$	3	4.5	6	μA
I_{CES}	Zero Gate Voltage Collector Current	$V_{CE} = 900V, V_{GE} = 0V$			350 1500	
I_{GES}	Gate-Emitter Leakage Current	$V_{GS} = \pm 30V$			± 100	nA

Dynamic Characteristics
 $T_J = 25^\circ\text{C}$ unless otherwise specified
APT64GA90L_B2D30

Symbol	Parameter	Test Conditions	Min	Typ	Max	Unit
C_{ies}	Input Capacitance	Capacitance $V_{GE} = 0V, V_{CE} = 25V$ $f = 1\text{MHz}$		3525		pF
C_{oes}	Output Capacitance			318		
C_{res}	Reverse Transfer Capacitance			53		
Q_g^3	Total Gate Charge	Gate Charge $V_{GE} = 15V$ $V_{CE} = 450V$ $I_C = 38A$		162		nC
Q_{ge}	Gate-Emitter Charge			26		
Q_{gc}	Gate-Collector Charge			64		
SSOA	Switching Safe Operating Area	$T_J = 150^\circ\text{C}, R_G = 4.7\Omega^4, V_{GE} = 15V,$ $L = 100\mu\text{H}, V_{CE} = 900V$	193			A
$t_{d(on)}$	Turn-On Delay Time	Inductive Switching (25°C) $V_{CC} = 600V$ $V_{GE} = 15V$ $I_C = 38A$ $R_G = 4.7\Omega^4$ $T_J = +25^\circ\text{C}$		18		ns
t_r	Current Rise Time			26		
$t_{d(off)}$	Turn-Off Delay Time			131		
t_f	Current Fall Time			104		
E_{on2}	Turn-On Switching Energy			1192		
E_{off}^6	Turn-Off Switching Energy		1088		μJ	
$t_{d(on)}$	Turn-On Delay Time	Inductive Switching (125°C) $V_{CC} = 600V$ $V_{GE} = 15V$ $I_C = 38A$ $R_G = 4.7\Omega^4$ $T_J = +125^\circ\text{C}$		17		ns
t_r	Current Rise Time			27		
$t_{d(off)}$	Turn-Off Delay Time			181		
t_f	Current Fall Time			171		
E_{on2}	Turn-On Switching Energy			1857		
E_{off}^6	Turn-Off Switching Energy		2311		μJ	

Thermal and Mechanical Characteristics

Symbol	Characteristic	Min	Typ	Max	Unit
$R_{\theta JC}$	Junction to Case Thermal Resistance (IGBT)	-	-	.25	$^\circ\text{C}/\text{W}$
$R_{\theta JC}$	Junction to Case Thermal Resistance (Diode)			0.8	
W_T	Package Weight	-	6.1	-	g
Torque	Mounting Torque (TO-264 Package), 4-40 or M3 screw			10	in-lbf

1 Repetitive Rating: Pulse width and case temperature limited by maximum junction temperature.

2 Pulse test: Pulse Width < $380\mu\text{s}$, duty cycle < 2%.

3 See Mil-Std-750 Method 3471.

4 R_G is external gate resistance, not including internal gate resistance or gate driver impedance. (MIC4452)

5 E_{on2} is the clamped inductive turn on energy that includes a commutating diode reverse recovery current in the IGBT turn on energy loss. A combi device is used for the clamping diode.

6 E_{off} is the clamped inductive turn-off energy measured in accordance with JEDEC standard JESD24-1.

Microsemi reserves the right to change, without notice, the specifications and information contained herein.

Typical Performance Curves

APT64GA90L_B2D30

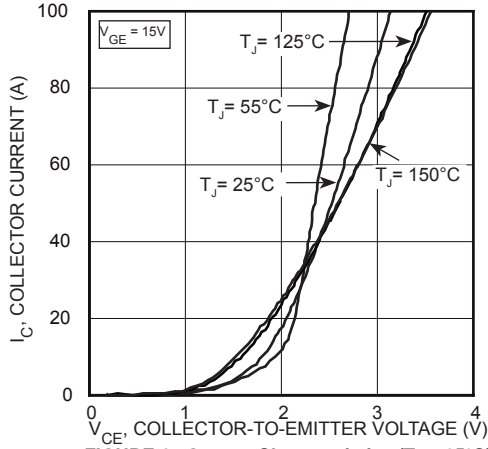

FIGURE 1, Output Characteristics ($T_J = 25^\circ\text{C}$)

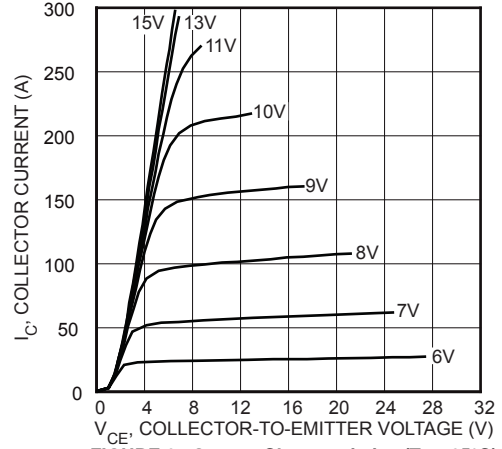

FIGURE 2, Output Characteristics ($T_J = 25^\circ\text{C}$)

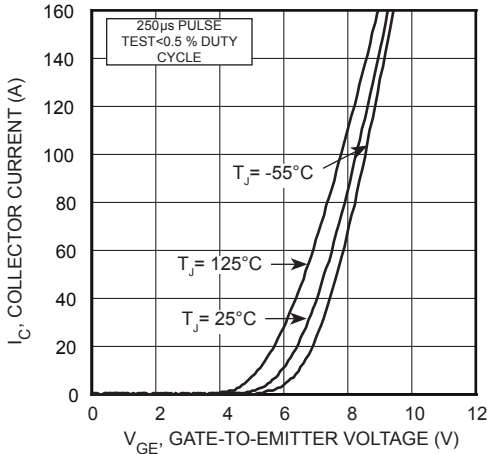

FIGURE 3, Transfer Characteristics

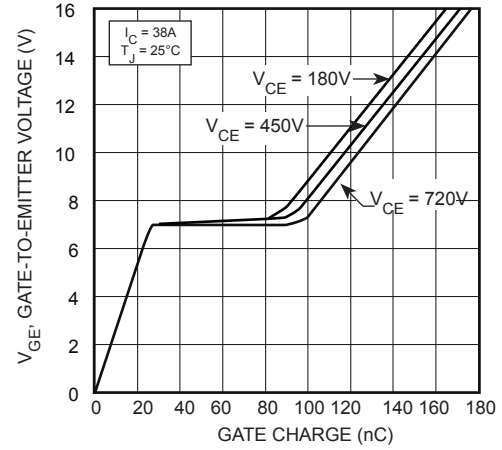

FIGURE 4, Gate charge

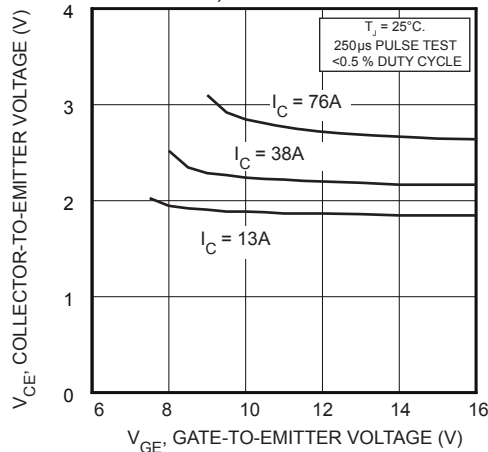

FIGURE 5, On State Voltage vs Gate-to-Emitter Voltage

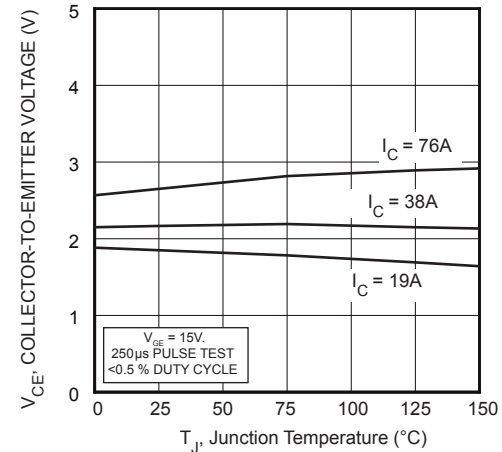

FIGURE 6, On State Voltage vs Junction Temperature

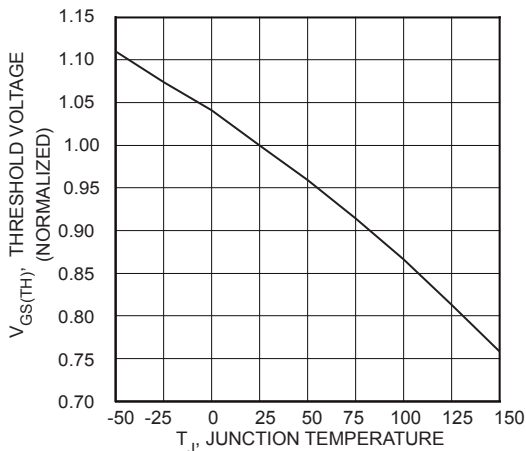

FIGURE 7, Threshold Voltage vs Junction Temperature

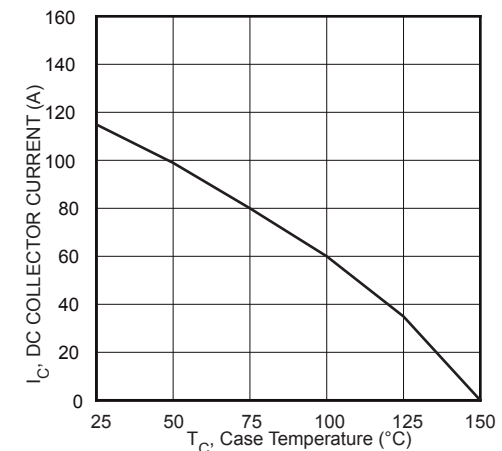

FIGURE 8, DC Collector Current vs Case Temperature

Typical Performance Curves

APT64GA90L_B2D30

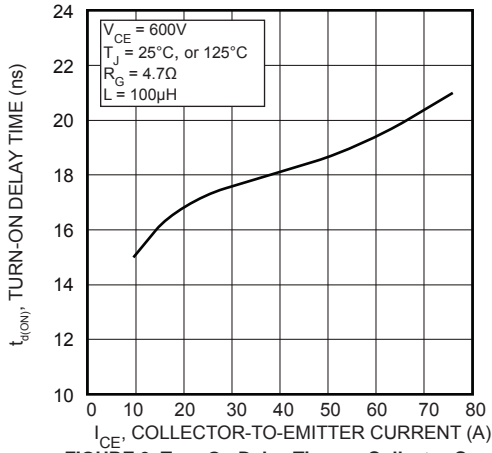

FIGURE 9, Turn-On Delay Time vs Collector Current

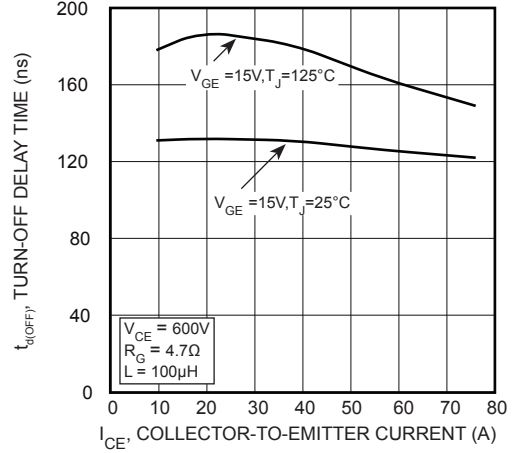

FIGURE 10, Turn-Off Delay Time vs Collector Current

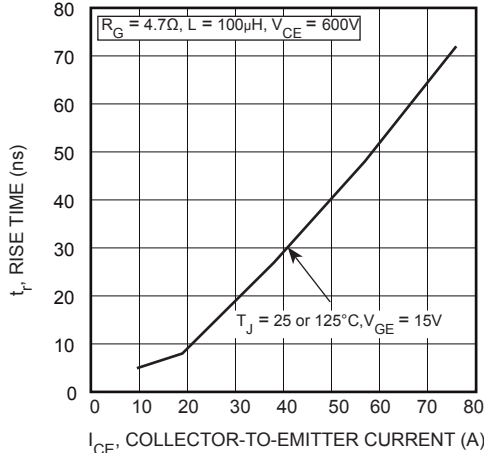

FIGURE 11, Current Rise Time vs Collector Current

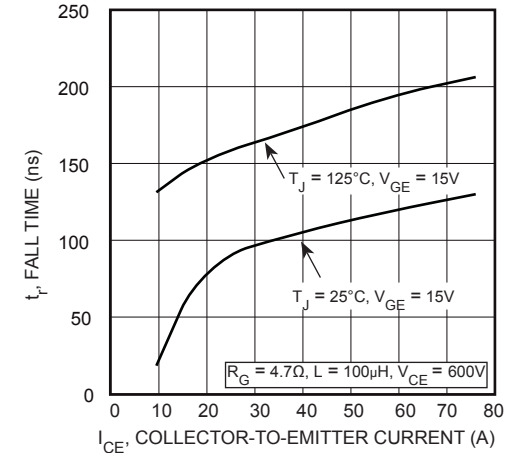

FIGURE 12, Current Fall Time vs Collector Current

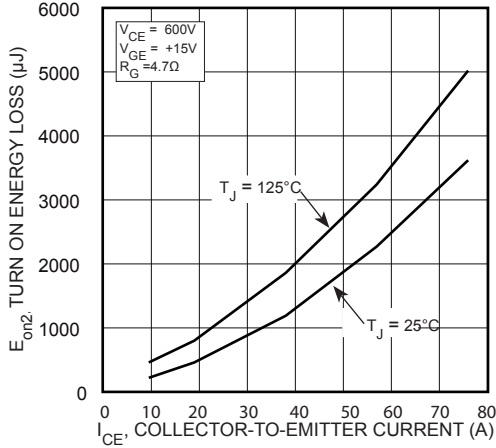

FIGURE 13, Turn-On Energy Loss vs Collector Current

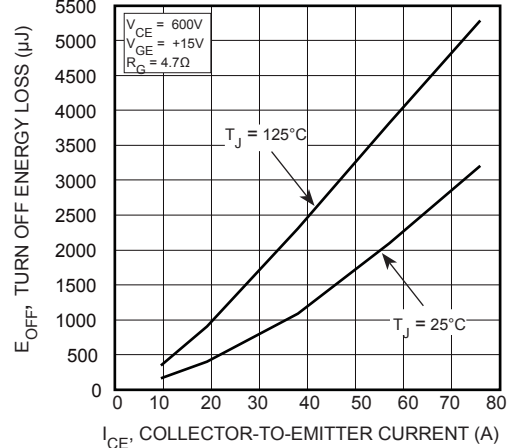

FIGURE 14, Turn-Off Energy Loss vs Collector Current

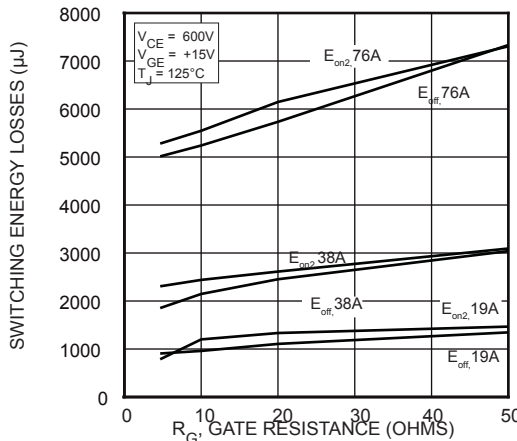

FIGURE 15, Switching Energy Losses vs Gate Resistance

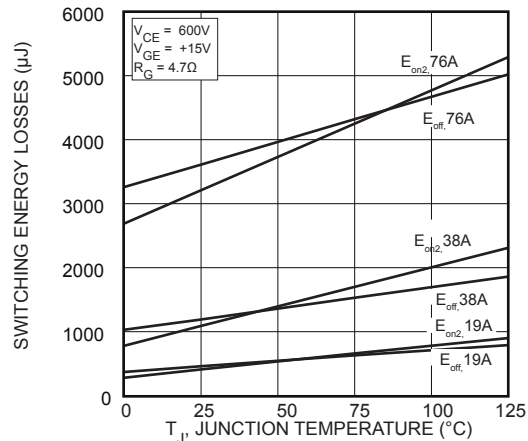

FIGURE 16, Switching Energy Losses vs Junction Temperature

Typical Performance Curves

APT64GA90L_B2D30

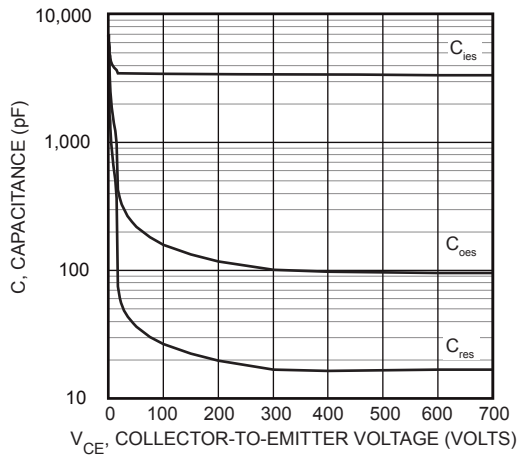

FIGURE 17, Capacitance vs Collector-To-Emitter Voltage

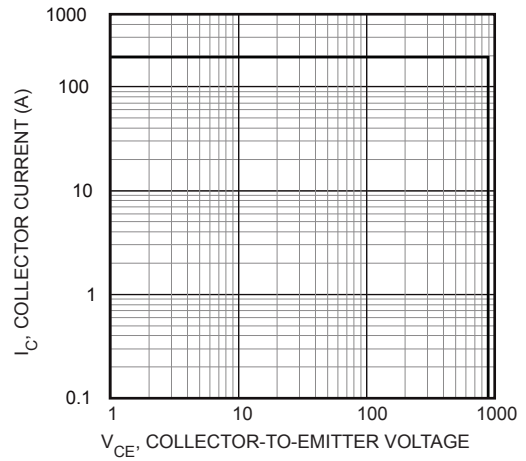

FIGURE 18, Minimum Switching Safe Operating Area

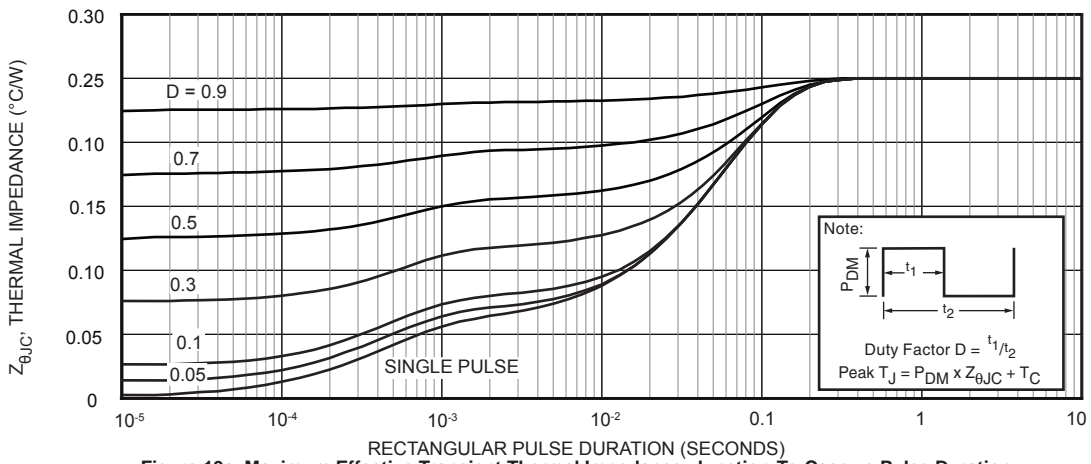

Figure 19a, Maximum Effective Transient Thermal Impedance, Junction-To-Case vs Pulse Duration

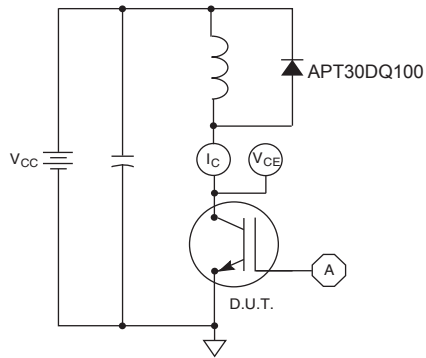

Figure 20, Inductive Switching Test Circuit

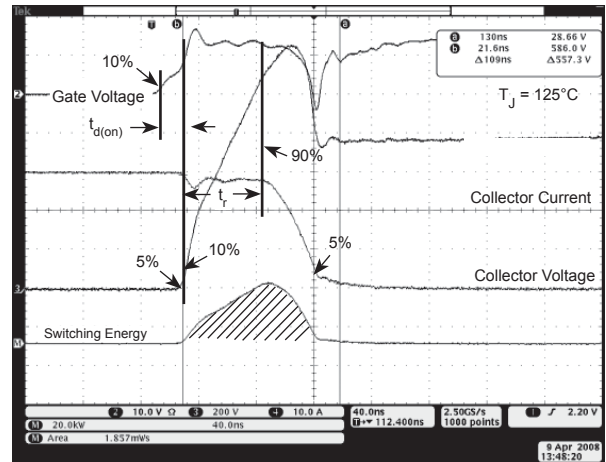

Figure 21, Turn-on Switching Waveforms and Definitions

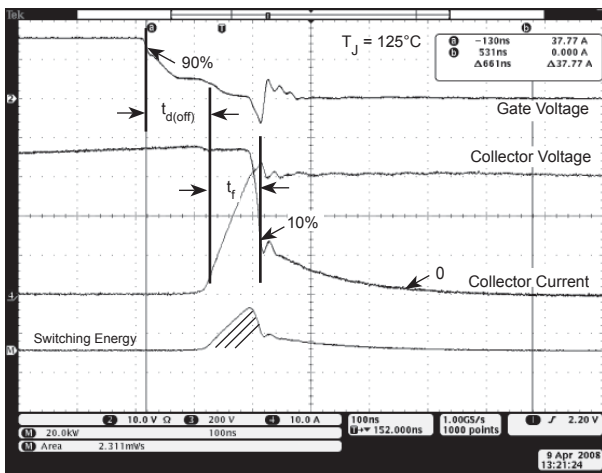

Figure 22, Turn-off Switching Waveforms and Definitions

ULTRAFAST SOFT RECOVERY RECTIFIER DIODE

MAXIMUM RATINGS

All Ratings: $T_C = 25^\circ\text{C}$ unless otherwise specified.

Symbol	Characteristic / Test Conditions	APT64GA90L_B2D30	Unit
$I_{F(AV)}$	Maximum Average Forward Current ($T_C = 102^\circ\text{C}$, Duty Cycle = 0.5)	30	Amps
$I_{F(RMS)}$	RMS Forward Current (Square wave, 50% duty)	43	
I_{FSM}	Non-Repetitive Forward Surge Current ($T_J = 45^\circ\text{C}$, 8.3 ms)	150	

STATIC ELECTRICAL CHARACTERISTICS

Symbol	Characteristic / Test Conditions	Min	Type	Max	Unit
V_F	Forward Voltage		$I_F = 30\text{A}$	2.5	Volts
			$I_F = 60\text{A}$	3.06	
			$I_F = 30\text{A}, T_J = 125^\circ\text{C}$	1.92	

DYNAMIC CHARACTERISTICS

Symbol	Characteristic	Test Conditions	Min	Typ	Max	Unit
t_{rr}	Reverse Recovery Time	$I_F = 1\text{A}, di_F/dt = -100\text{A}/\mu\text{s}, V_R = 30\text{V}, T_J = 25^\circ\text{C}$	-	24	-	ns
t_{rr}	Reverse Recovery Time	$I_F = 30\text{A}, di_F/dt = -200\text{A}/\mu\text{s}, V_R = 667\text{V}, T_C = 25^\circ\text{C}$	-	295	-	ns
Q_{rr}	Reverse Recovery Charge		-	440	-	
I_{RRM}	Maximum Reverse Recovery Current	$I_F = 30\text{A}, di_F/dt = -200\text{A}/\mu\text{s}, V_R = 667\text{V}, T_C = 125^\circ\text{C}$	-	4	-	Amps
t_{rr}	Reverse Recovery Time		-	330	-	ns
Q_{rr}	Reverse Recovery Charge	$I_F = 30\text{A}, di_F/dt = -1000\text{A}/\mu\text{s}, V_R = 667\text{V}, T_C = 125^\circ\text{C}$	-	1550	-	nC
I_{RRM}	Maximum Reverse Recovery Current		-	8	-	Amps
t_{rr}	Reverse Recovery Time	$I_F = 30\text{A}, di_F/dt = -1000\text{A}/\mu\text{s}, V_R = 667\text{V}, T_C = 125^\circ\text{C}$	-	150	-	ns
Q_{rr}	Reverse Recovery Charge		-	2250	-	nC
I_{RRM}	Maximum Reverse Recovery Current		-	25	-	Amps

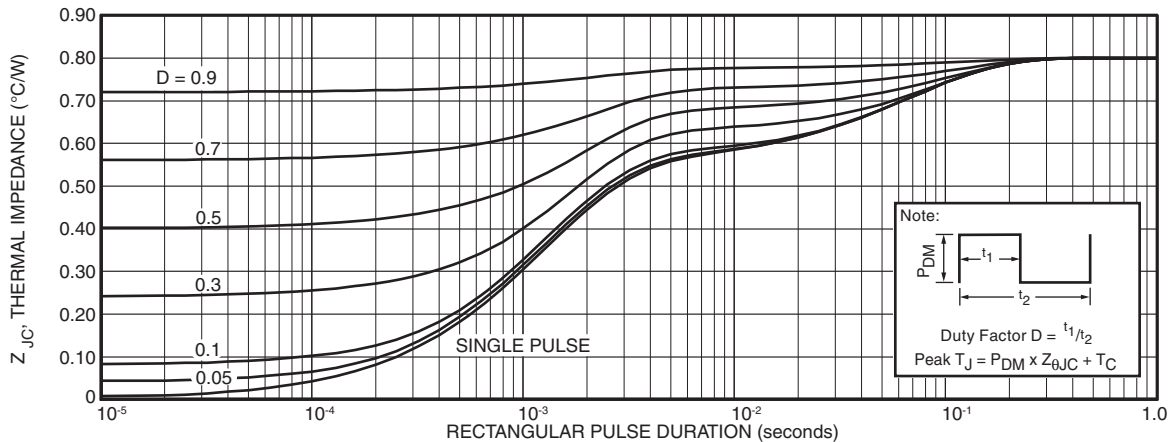

FIGURE 1a. MAXIMUM EFFECTIVE TRANSIENT THERMAL IMPEDANCE, JUNCTION-TO-CASE vs. PULSE DURATION

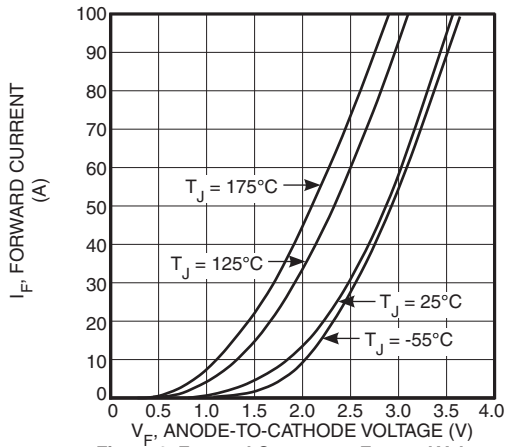

Figure 2. Forward Current vs. Forward Voltage

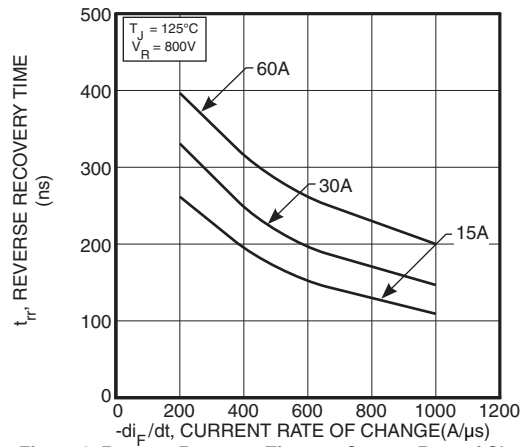

Figure 3. Reverse Recovery Time vs. Current Rate of Change

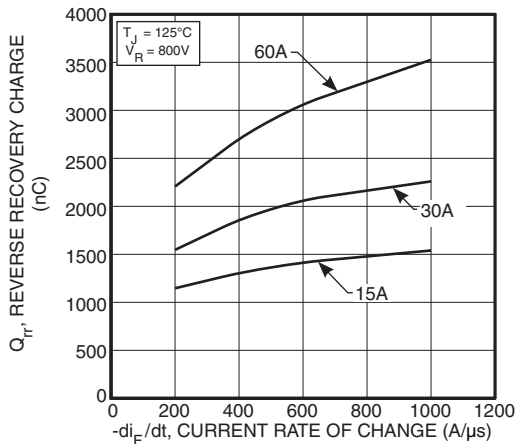

Figure 4. Reverse Recovery Charge vs. Current Rate of Change

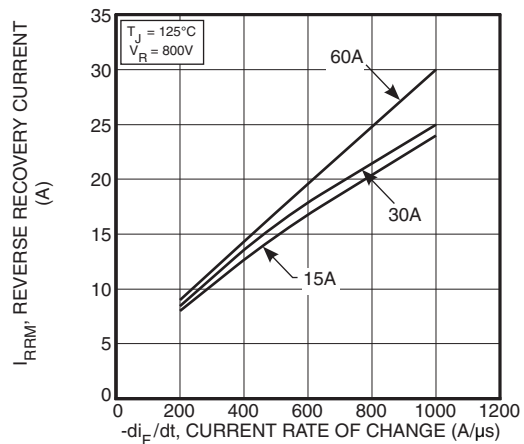

Figure 5. Reverse Recovery Current vs. Current Rate of Change

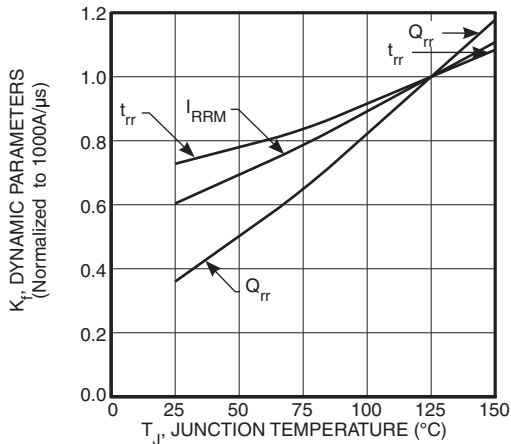

Figure 6. Dynamic Parameters vs. Junction Temperature

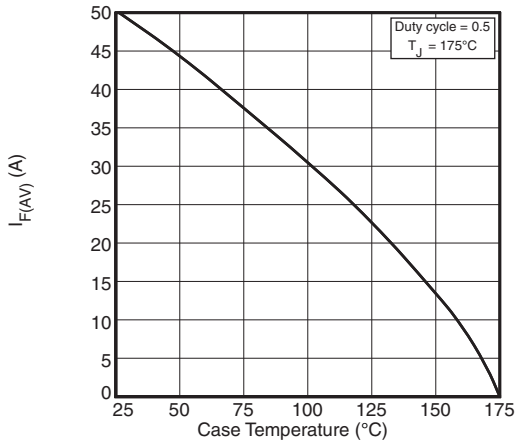

Figure 7. Maximum Average Forward Current vs. Case Temperature

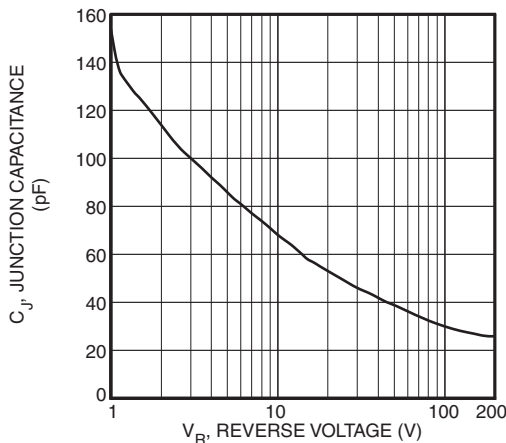

Figure 8. Junction Capacitance vs. Reverse Voltage

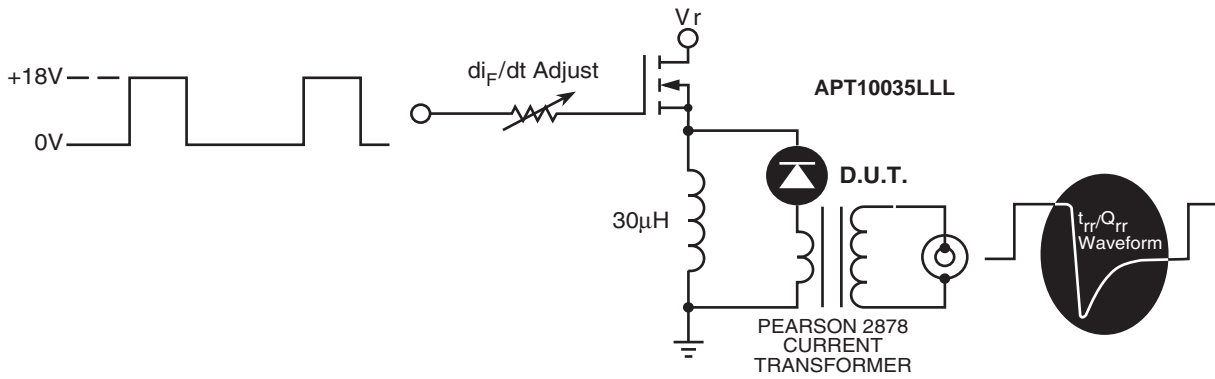

Figure 9. Diode Test Circuit

- 1 I_F - Forward Conduction Current
- 2 di_F/dt - Rate of Diode Current Change Through Zero Crossing.
- 3 I_{RRM} - Maximum Reverse Recovery Current.
- 4 t_{rr} - Reverse Recovery Time, measured from zero crossing where diode current goes from positive to negative, to the point at which the straight line through I_{RRM} and 0.25•I_{RRM} passes through zero.
- 5 Q_{rr} - Area Under the Curve Defined by I_{RRM} and t_{rr}.

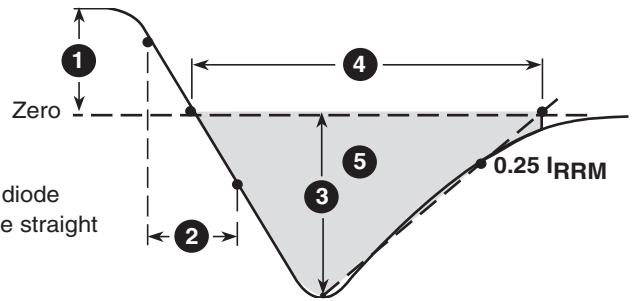
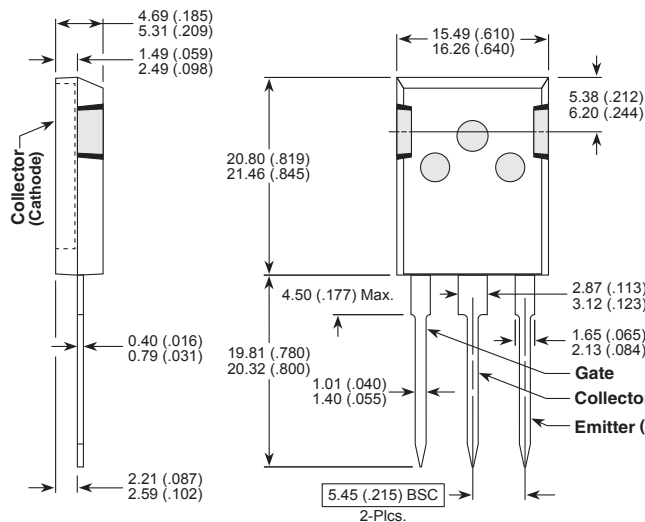

Figure 10, Diode Reverse Recovery Waveform and Definitions

T-MAX™ (B2) Package Outline



These dimensions are equal to the TO-247 without the mounting hole.
Dimensions in Millimeters and (Inches)

TO-264 (L) Package Outline

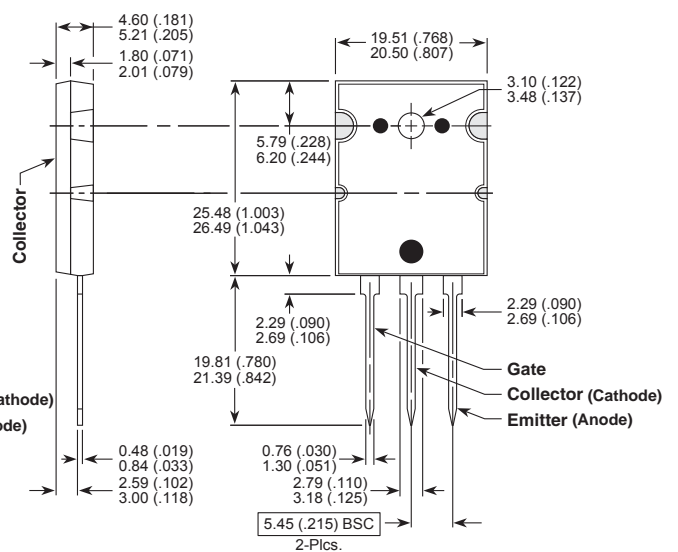

Dimensions in Millimeters and (Inches)