



UK3919

Power MOSFET

SWITCHING N-CHANNEL POWER MOSFET

DESCRIPTION

This **UK3919** N-Channel Logic Level MOSFET is produced using UTC Semiconductor advanced Power Trench process which has been tailored to make the on-state resistance minimum and yet maintain low gate charge for superior switching performance especially.

The **UK3919** is well suited for where low in-line power loss is needed in a very small outline surface mount package, such as low voltage and battery powered applications.

FEATURES

- * $R_{DS(ON)} = 5.6m\Omega @ V_{GS} = 10 V$
- * Low capacitance
- * Optimized gate charge
- * Fast switching capability
- * Avalanche energy specified

SYMBOL

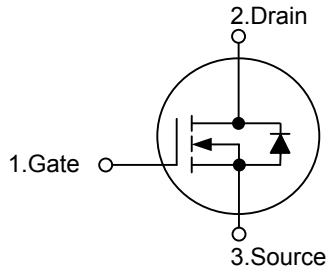

ORDERING INFORMATION

Ordering Number		Package	Pin Assignment			Packing
Normal	Lead Free Plating		1	2	3	
UK3919-TN3-R	UK3919L-TN3-R	TO-252	G	D	S	Tape Reel
UK3919-TN3-T	UK3919L-TN3-T	TO-252	G	D	S	Tube

<p>UK3919L-TN3-R</p> <p>(1)Packing Type</p> <p>(2)Package Type</p> <p>(3)Lead Plating</p>	<p>(1) R: Tape Reel, T: Tube</p> <p>(2) TN3:TO-252</p> <p>(3) L: Lead Free Plating, Blank: Pb/Sn</p>
---	--

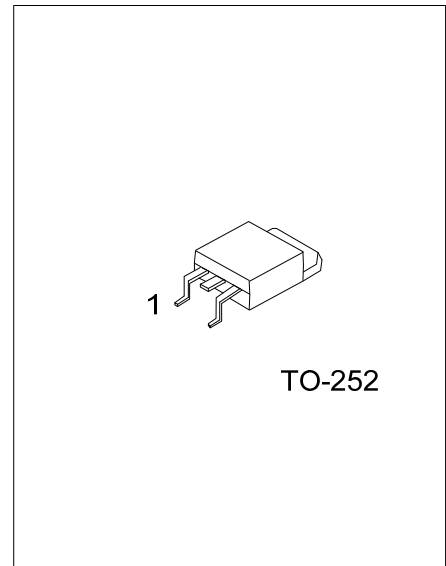

*Pb-free plating product number:UK3919L

■ ABSOLUTE MAXIMUM RATINGS ($T_C = 25^\circ\text{C}$, unless otherwise specified)

PARAMETER	SYMBOL	RATINGS	UNIT
Drain to Source Voltage	V_{DS}	25	V
Gate to Source Voltage	V_{GS}	± 20	V
Continuous Drain Current	I_D	± 64	A
Pulsed Drain Current (Note1)	I_{DM}	± 256	A
Single Avalanche Current (Note2)	I_{AS}	27	A
Single Avalanche Energy (Note2)	E_{AS}	73	mJ
Total Power Dissipation	P_D	36	W
Storage Temperature	T_{STG}	-55 ~ +150	$^\circ\text{C}$

Note: Absolute maximum ratings are those values beyond which the device could be permanently damaged.

Absolute maximum ratings are stress ratings only and functional device operation is not implied.

■ ELECTRICAL CHARACTERISTICS ($T_C = 25^\circ\text{C}$, unless otherwise specified)

PARAMETER	SYMBOL	TEST CONDITIONS	MIN	TYP	MAX	UNIT
OFF CHARACTERISTICS						
Zero Gate Voltage Drain Current	I_{DSS}	$V_{DS} = 25\text{ V}, V_{GS} = 0\text{ V}$			10	μA
Gate-Body Leakage Current	I_{GSS}	$V_{DS} = 0\text{ V}, V_{GS} = \pm 20\text{ V}$			± 100	nA
ON CHARACTERISTICS						
Gate-Threshold Voltage	$V_{GS(OFF)}$	$V_{DS} = 10\text{ V}, I_D = 1\text{ mA}$	2.0	2.5	3.0	V
Drain-Source On-Resistance	$R_{DS(ON)}$	$V_{GS} = 10\text{ V}, I_D = 32\text{ A}$		4.5	5.6	m Ω
		$V_{GS} = 5.0\text{ V}, I_D = 16\text{ A}$		6.8	13.7	
DYNAMIC PARAMETERS						
Input Capacitance	C_{ISS}	$V_{DS} = 10\text{ V}, V_{GS} = 0\text{ V}, f = 1\text{ MHz}$		2050		pF
Output Capacitance	C_{OSS}			460		
Reverse Transfer Capacitance	C_{RSS}			330		
SWITCHING PARAMETERS						
Gate to Source Charge	Q_G	$V_{DD} = 20\text{ V}, V_{GS} = 10\text{ V}, I_D = 64\text{ A}$		42		nC
Gate Charge at Threshold	Q_{GS}			8		
Gate to Drain Charge	Q_{GD}			15		
Turn-ON Delay Time	$t_{D(ON)}$	$V_{DD} = 12.5\text{ V}, I_D = 32\text{ A}, V_{GS} = 10\text{ V}, R_G = 10\ \Omega$		16		ns
Turn-ON Rise Time	t_R			19		
Turn-OFF Delay Time	$t_{D(OFF)}$			53		
Turn-OFF Fall-Time	t_F			22		
SOURCE- DRAIN DIODE RATINGS AND CHARACTERISTICS						
Body Diode Forward Voltage	V_{SD}	$I_F = 64\text{ A}, V_{GS} = 0\text{ V}$		0.97		V
Reverse Recovery Time	t_{RR}	$I_F = 64\text{ A}, V_{GS} = 0\text{ V}, di/dt = 100\text{ A}/\mu\text{s}$		23		ns
Reverse Recovery Charge	Q_{RR}			11		nC

Notes: 1. $PW \leq 10\ \mu\text{s}$, Duty Cycle $\leq 1\%$

2. Starting $T_{CH} = 25^\circ\text{C}$, $V_{DD} = 12.5\text{ V}$, $R_G = 25\ \Omega$, $V_{GS} = 20 \rightarrow 0\text{ V}$

TYPICAL CHARACTERISTICS

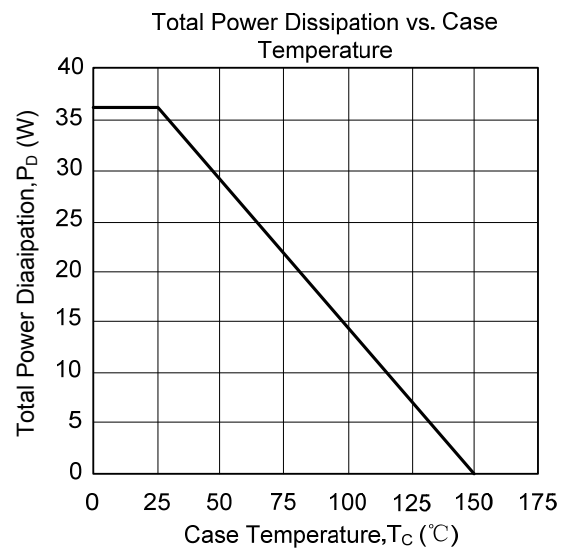
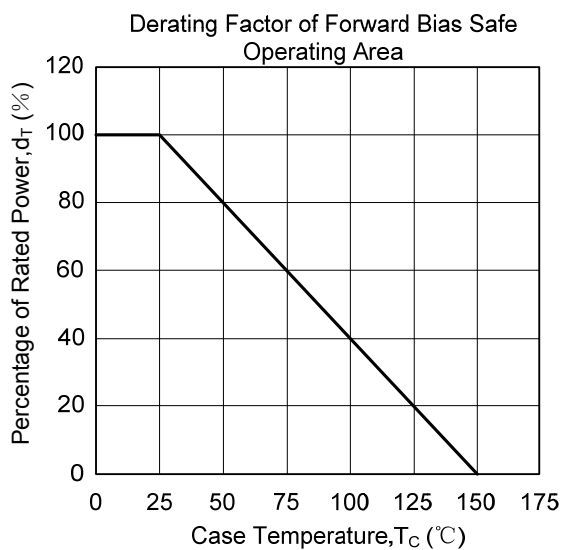
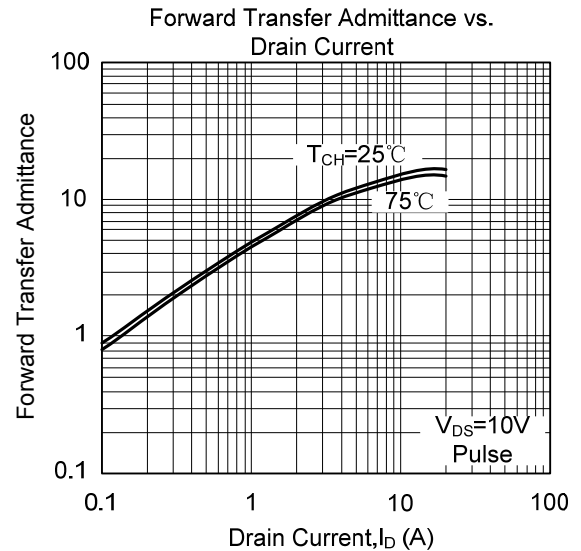
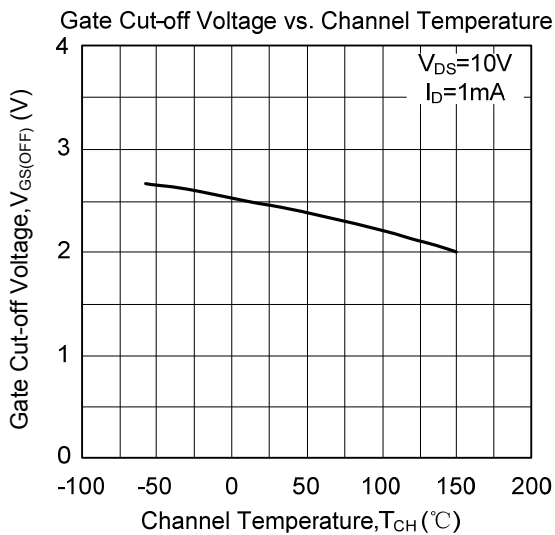
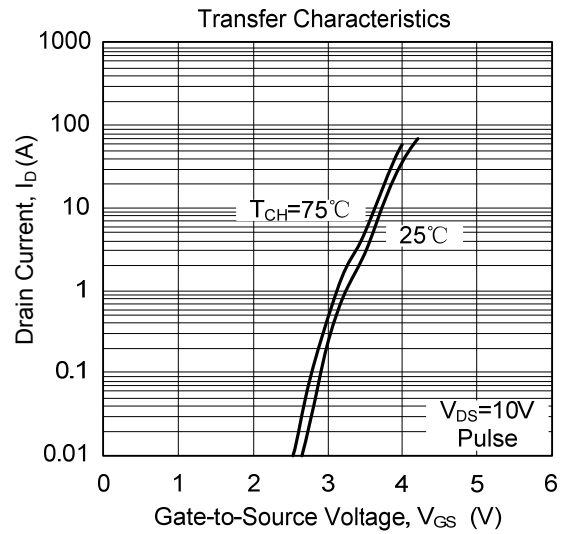
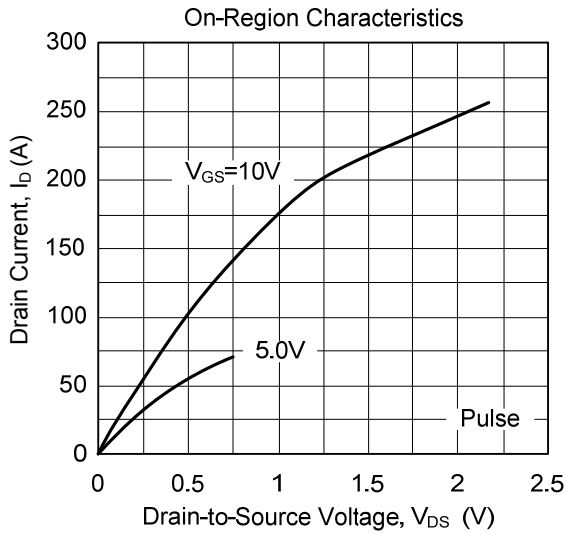

■ TYPICAL CHARACTERISTICS(Cont.)

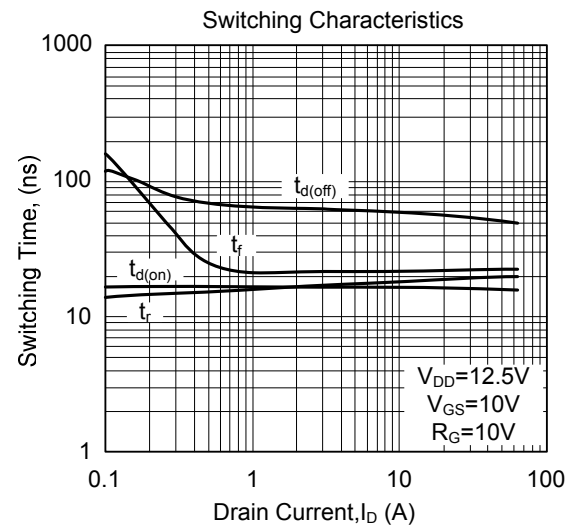
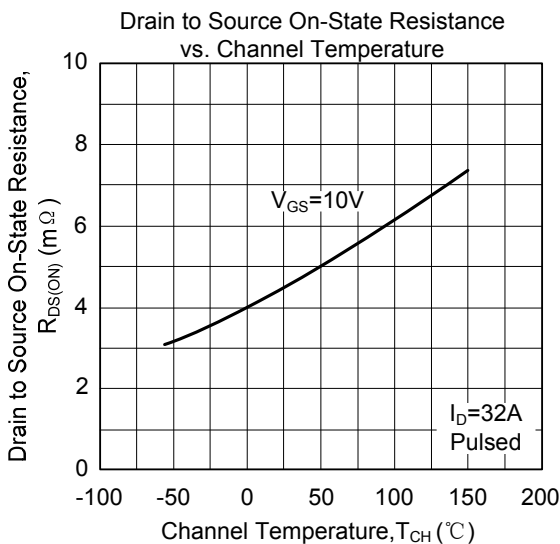
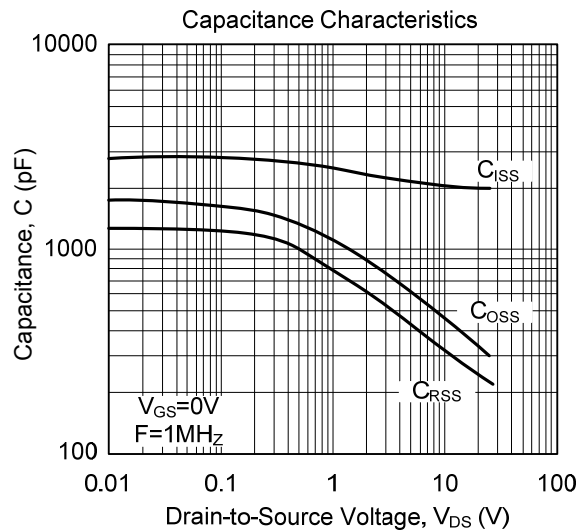
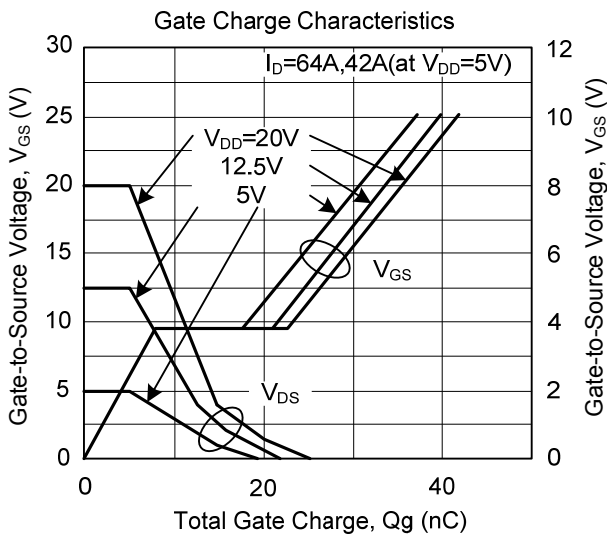
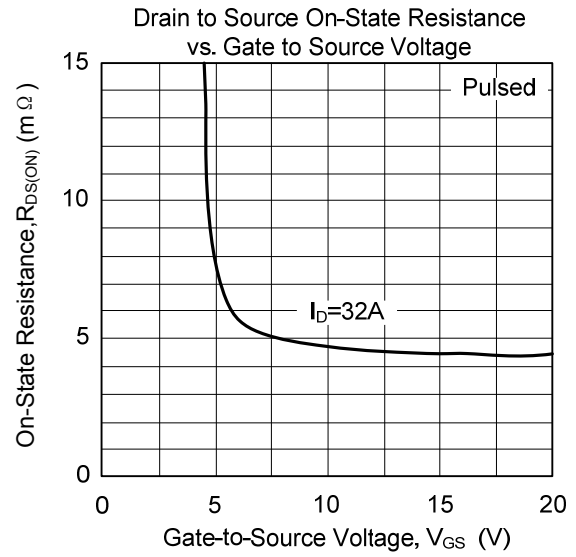
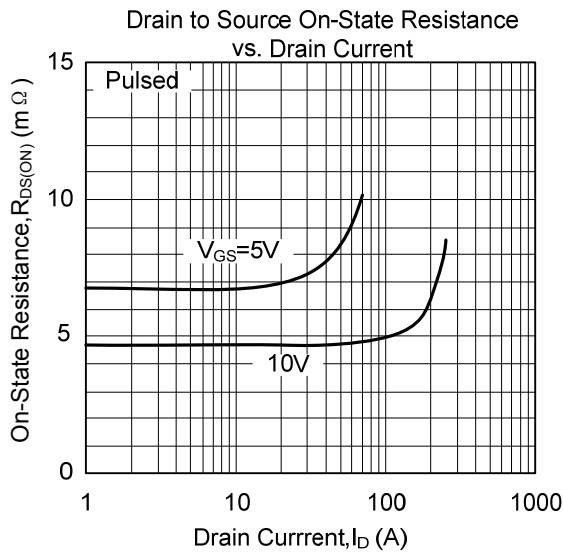

■ TYPICAL CHARACTERISTICS(Cont.)

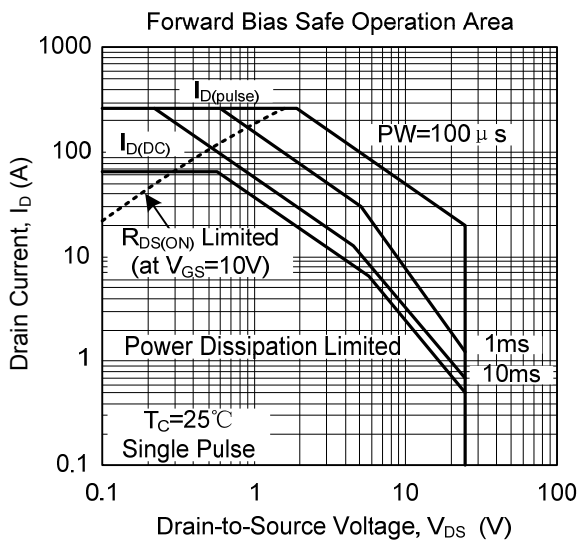
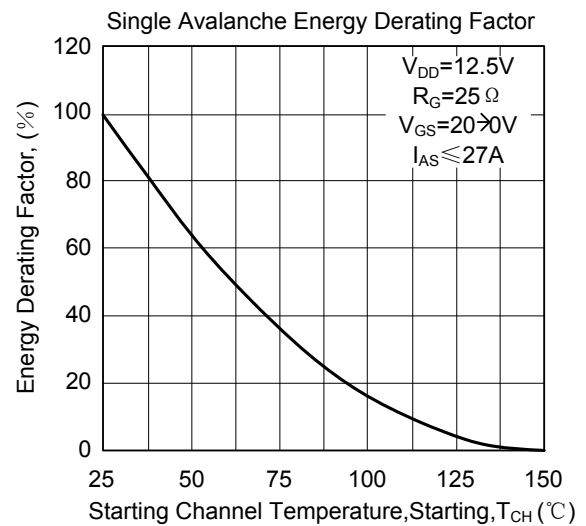
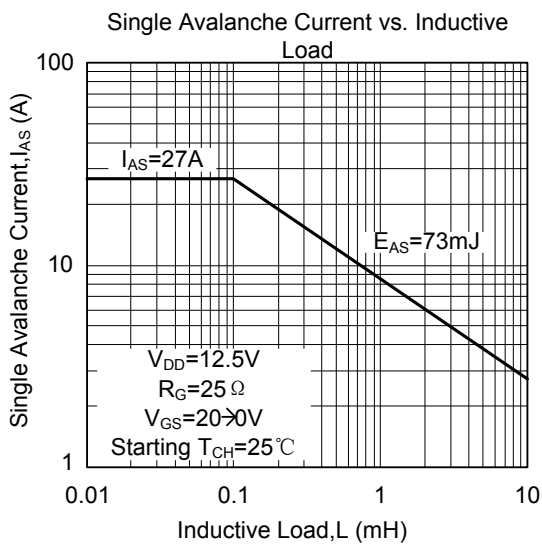
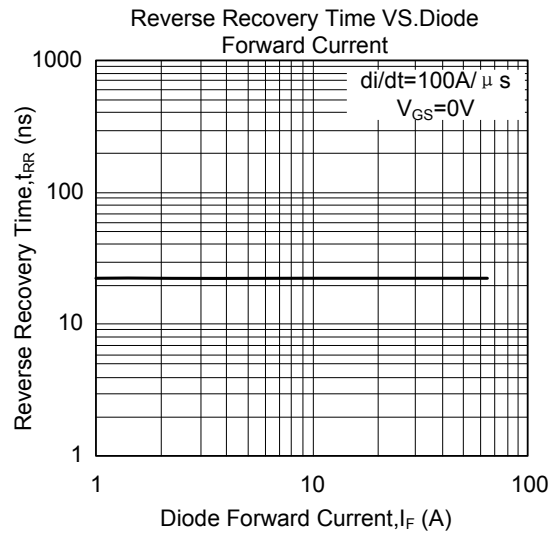
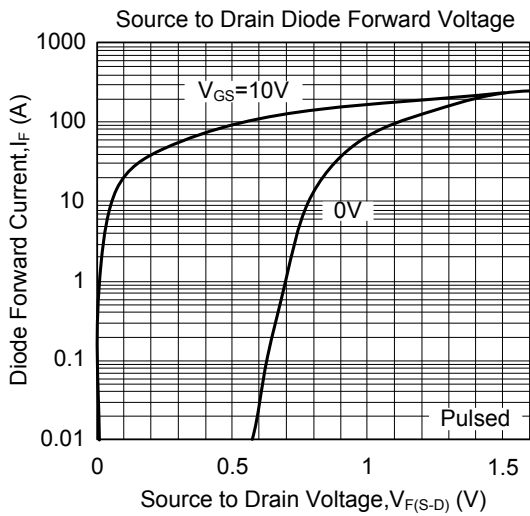

■ TYPICAL CHARACTERISTICS(Cont.)

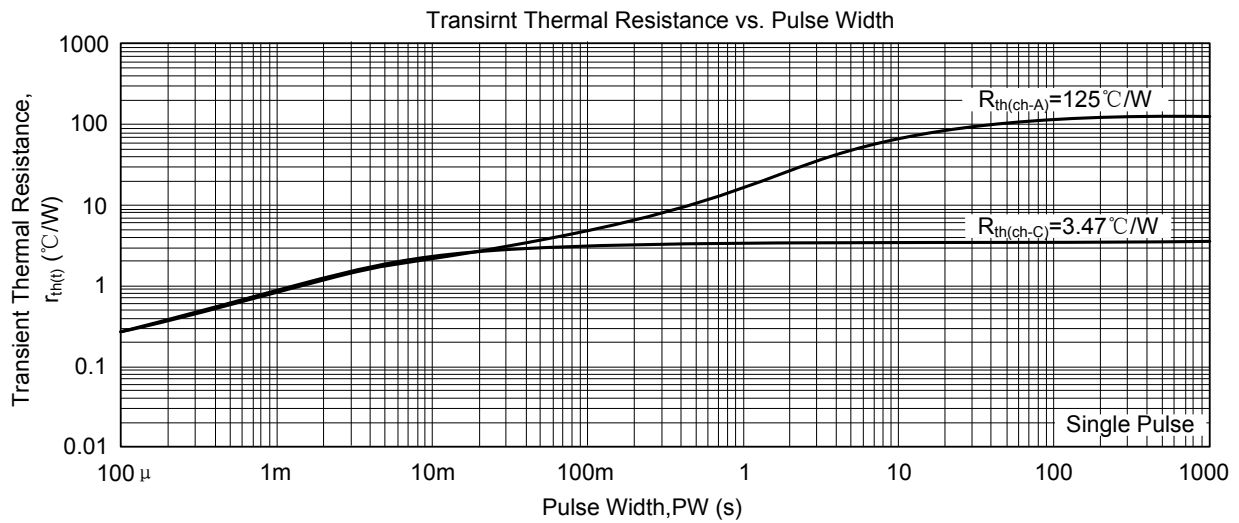

UTC assumes no responsibility for equipment failures that result from using products at values that exceed, even momentarily, rated values (such as maximum ratings, operating condition ranges, or other parameters) listed in products specifications of any and all UTC products described or contained herein. UTC products are not designed for use in life support appliances, devices or systems where malfunction of these products can be reasonably expected to result in personal injury. Reproduction in whole or in part is prohibited without the prior written consent of the copyright owner. The information presented in this document does not form part of any quotation or contract, is believed to be accurate and reliable and may be changed without notice.