

T1G6000528-Q3

7W, 28V, DC – 6 GHz, GaN RF Power Transistor



Applications

- Wideband and narrowband defense and commercial communication systems
 - General Purpose RF Power
 - Jammers
 - Radar
 - Professional radio systems
 - WiMAX
 - Wideband amplifiers
 - Test instrumentation
 - Cellular infrastructure

Available Package



Product Features

- Frequency: DC to 6 GHz
- Linear Gain: >10 dB at 6 GHz
- Operating Voltage: 28 V
- Output Power (P_{3dB}): >7 W at 6 GHz
- Lead-free and RoHS compliant
- Low thermal resistance package

Package Information

Package Type	Description	Base
Q3	5.0mm x 4.0mm ceramic air cavity straight lead package	CuMo

General Description

The TriQuint T1G6000528-Q3 is a 7 W (P_{3dB}) discrete GaN on SiC HEMT which operates from DC to 6 GHz and typically provides >10 dB gain at 6 GHz. The device is constructed with TriQuint's proven 0.25 μ m production process, which features advanced field plate techniques to optimize power and efficiency at high drain bias operating conditions. This optimization can potentially lower system costs in terms of fewer amplifier line-ups and lower thermal management costs.

Ordering Information

Material No.	Part No.	Description	ECCN
1075579	T1G6000528-Q3	Packaged part	EAR99
1081733	T1G6000528-Q3-EVB3	Narrowband 3.0 to 3.5 GHz evaluation board	EAR99

T1G6000528-Q3

7W, 28V, DC – 6 GHz, GaN RF Power Transistor



Specifications

Absolute Maximum Ratings¹

Sym	Parameter	Value
V ⁺	Positive Supply Value ²	28
V ⁻	Negative Supply Voltage Range	- 10V to 0V
I	Positive Supply Current ²	0.8 A
I _G	Gate Supply Current	12.5 mA
P _D	Power Dissipation ²	10 W
T _{CH}	Operating Channel Temperature ²	200°C

Notes:

- ¹ Absolute maximum ratings at 3 GHz
- ² Absolute maximum ratings are set based on industry recommended standard mean time to failure (MTTF) greater than 1M hours while operating at a maximum case temperature of 85C. Operating at lower maximum case temperatures allows maximum operating voltage to be increased up to a maximum of 40V. Application specific limits can be determined with engineering guidance from TriQuint.

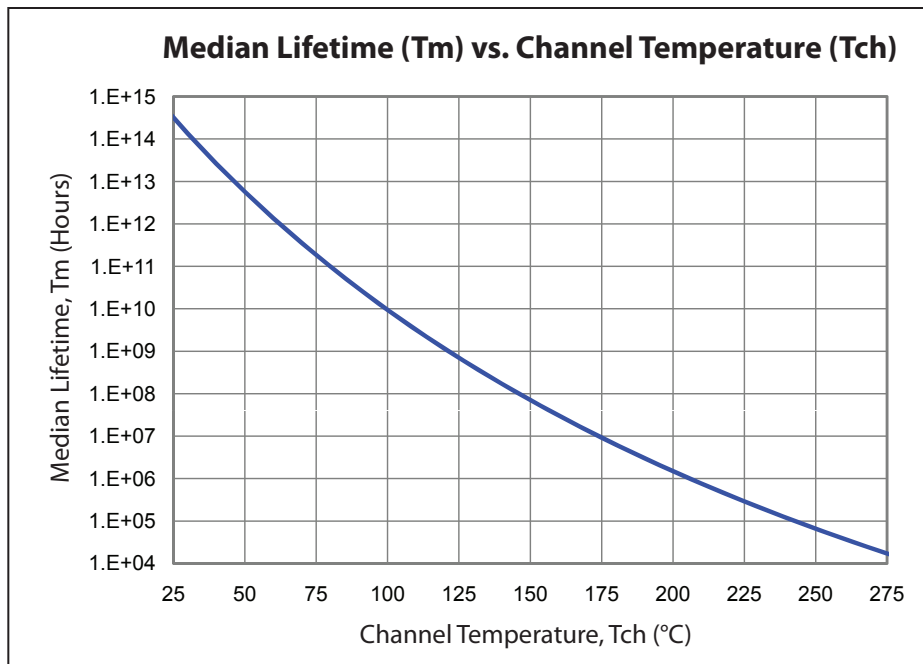

T1G6000528-Q3

7W, 28V, DC – 6 GHz, GaN RF Power Transistor



Specifications

Thermal Information

Test Conditions	T_{CH} (°C)	Θ_{JC} (°C/W) ¹
DC at 85°C Case	199	11.2

Notes:

¹ Thermal resistance (channel to backside of case)

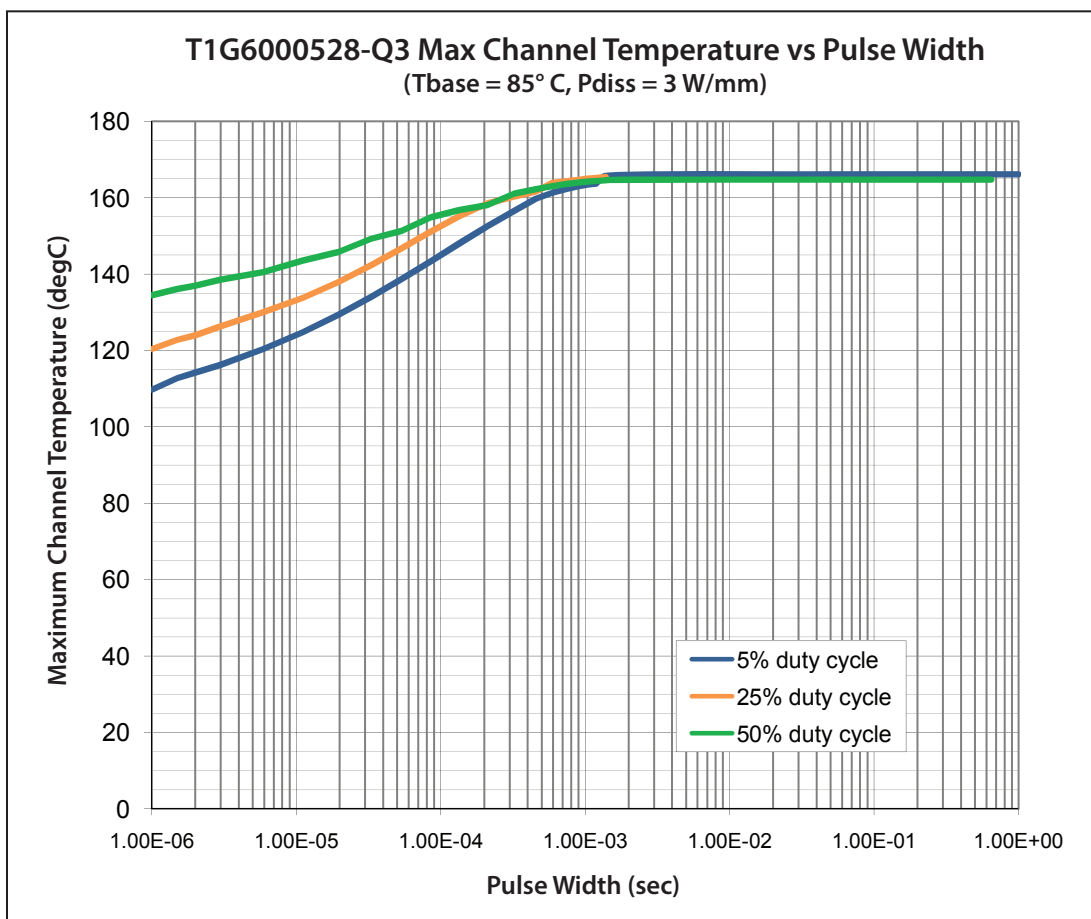

T1G6000528-Q3

7W, 28V, DC – 6 GHz, GaN RF Power Transistor



Electrical Specifications

Recommended operating conditions apply unless otherwise specified: $T_A=25\text{ }^\circ\text{C}$

DC Characteristics

Characteristics	Symbol	Min	Typ	Max	Unit	Conditions
Break-Down Voltage Drain Source	BV_{DSX}	85	120		V	$V_{GS} = -8\text{ V}; I_D = 1\text{ mA}$
Gate Quiescent Voltage	$V_{GS(Q)}$		-3.9		V	$V_{DS} = 28\text{ V}; I_{DQ} = 100\text{ mA}$
Gate Threshold Voltage	$V_{GS(th)}$		-4.5		V	$V_{DS} = 10\text{ V}; I_D = 5\text{ mA}$
Saturated Drain Current	I_{DSX}		2		A	$V_{DS} = 5\text{ V}; V_{GS} = 0\text{ V}$

RF Characteristics

Characteristics	Symbol	Min	Typ	Max	Unit
Load Pull Performance at 6.0 GHz ($V_{DS} = 28\text{ V}, I_{DQ} = 50\text{ mA}, CW$)					
Linear Gain	G_{LIN}	13.0	13.5		dB
Output Power at 3 dB Gain Compression	P_{3dB}	8.0	10.0		W
Drain Efficiency at 3 dB Gain Compression	DE_{3dB}	55	65		%
Power-Added Efficiency at 3 dB Gain Compression	PAE_{3dB}	50	55		%
Gain at 3 dB Compression	G_{3dB}	10.0	10.5		dB
Performance at 3.3 GHz in the 3.0 to 3.5 GHz Fixture ($V_{DS} = 28\text{ V}, I_{DQ} = 50\text{ mA}, 200\text{msec pulse}, 20\%$ duty-cycle)					
Linear Gain	G_{LIN}	15.5	16.9		dB
Output Power at 3 dB Gain Compression	P_{3dB}	8.9	11.0		W
Drain Efficiency at 3 dB Gain Compression	DE_{3dB}	55	58		%
Power-Added Efficiency at 3 dB Gain Compression	PAE_{3dB}	50	53		%
Gain at 3 dB Compression	G_{3dB}	12.5	13.9		dB
Narrowband Performance at 3.5 GHz ($V_{DS} = 28\text{ V}, I_{DQ} = 50\text{ mA}, CW$ at P1dB, applied for 3.5 secs)					
Impedance Mismatch Ruggedness	VSWR		10:1		

T1G6000528-Q3

7W, 28V, DC – 6 GHz, GaN RF Power Transistor



Device Characterization Data

S-Parameter Smith Chart

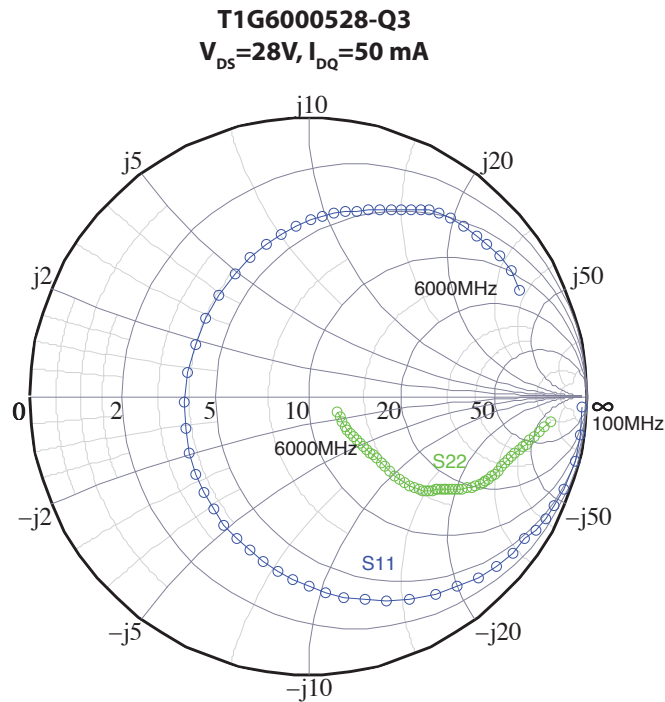

Small-Signal Gain

Maximum Stable Gain of T1G6000528-Q3

$V_{DS}=28V, I_{DQ}=50\text{ mA}$

Gmax vs. Frequency

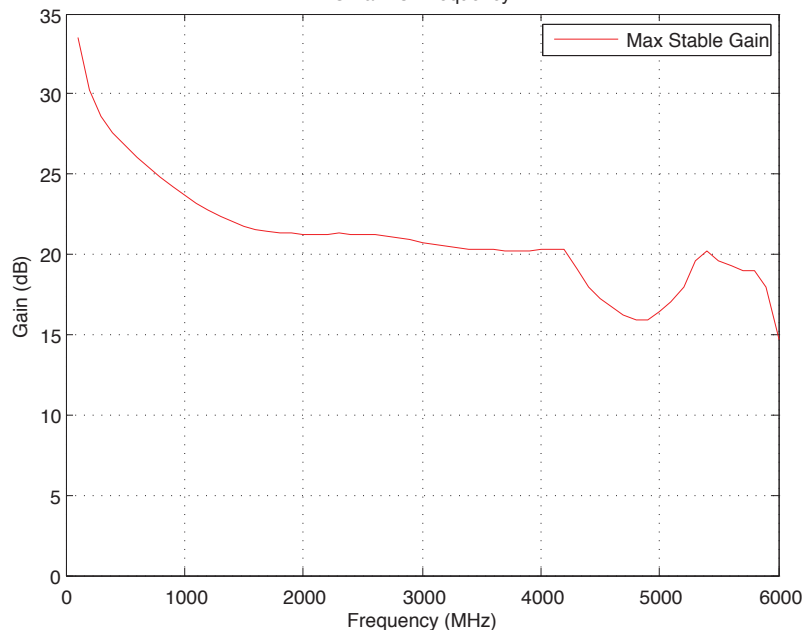

The data was taken in a package fixture. The reference planes are at the package interface.

T1G6000528-Q3

7W, 28V, DC – 6 GHz, GaN RF Power Transistor



S-Parameter Data ($V_{DS} = 28\text{ V}$, $I_{DQ} = 50\text{ mA}$)

Freq. [GHz]	Real S11	Imag S11	Real S21	Imag S21	Real S12	Imag S12	Real S22	Imag S22
0.1	0.892	-0.182	-14.955	4.241	0.005	0.005	0.440	-0.285
0.2	0.726	-0.593	-12.756	7.176	0.008	0.011	0.361	-0.316
0.3	0.438	-0.840	-10.636	9.084	0.012	0.015	0.294	-0.342
0.4	0.127	-0.926	-8.639	10.186	0.016	0.017	0.236	-0.362
0.5	-0.058	-0.910	-6.798	10.673	0.020	0.018	0.187	-0.379
0.6	-0.178	-0.894	-5.134	10.700	0.024	0.017	0.144	-0.391
0.7	-0.276	-0.856	-3.659	10.398	0.028	0.015	0.106	-0.401
0.8	-0.349	-0.817	-2.377	9.874	0.031	0.013	0.072	-0.409
0.9	-0.444	-0.777	-1.287	9.214	0.034	0.011	0.040	-0.415
1.0	-0.521	-0.726	-0.381	8.485	0.036	0.008	0.008	-0.422
1.1	-0.589	-0.669	0.353	7.737	0.037	0.006	-0.025	-0.428
1.2	-0.637	-0.608	0.929	7.010	0.038	0.004	-0.059	-0.435
1.3	-0.681	-0.558	1.365	6.329	0.038	0.002	-0.091	-0.441
1.4	-0.719	-0.501	1.677	5.712	0.037	0.000	-0.122	-0.447
1.5	-0.747	-0.452	1.886	5.168	0.037	-0.001	-0.149	-0.451
1.6	-0.769	-0.411	2.009	4.701	0.035	-0.002	-0.173	-0.454
1.7	-0.786	-0.375	2.066	4.309	0.034	-0.003	-0.194	-0.455
1.8	-0.799	-0.344	2.074	3.986	0.033	-0.004	-0.213	-0.454
1.9	-0.810	-0.315	2.049	3.724	0.031	-0.005	-0.231	-0.451
2.0	-0.818	-0.289	2.006	3.515	0.030	-0.005	-0.249	-0.446
2.1	-0.826	-0.263	1.958	3.348	0.028	-0.005	-0.268	-0.439
2.2	-0.833	-0.238	1.915	3.213	0.027	-0.006	-0.287	-0.431
2.3	-0.839	-0.214	1.886	3.099	0.026	-0.006	-0.306	-0.422
2.4	-0.844	-0.190	1.878	2.997	0.026	-0.006	-0.323	-0.412
2.5	-0.849	-0.166	1.895	2.899	0.025	-0.007	-0.339	-0.402
2.6	-0.853	-0.143	1.940	2.798	0.025	-0.007	-0.352	-0.393
2.7	-0.856	-0.119	2.012	2.689	0.025	-0.007	-0.363	-0.384
2.8	-0.858	-0.094	2.110	2.568	0.025	-0.007	-0.372	-0.377
2.9	-0.859	-0.067	2.231	2.432	0.026	-0.008	-0.380	-0.370
3.0	-0.858	-0.038	2.370	2.282	0.026	-0.008	-0.389	-0.364
3.1	-0.857	-0.006	2.522	2.118	0.027	-0.008	-0.397	-0.359
3.2	-0.854	0.028	2.678	1.941	0.028	-0.009	-0.406	-0.354
3.3	-0.850	0.063	2.832	1.755	0.029	-0.009	-0.414	-0.349
3.4	-0.845	0.098	2.974	1.564	0.030	-0.009	-0.424	-0.344
3.5	-0.839	0.132	3.097	1.371	0.030	-0.009	-0.433	-0.339
3.6	-0.833	0.165	3.193	1.182	0.031	-0.009	-0.443	-0.332
3.7	-0.825	0.196	3.252	1.002	0.031	-0.009	-0.453	-0.324
3.8	-0.817	0.226	3.268	0.835	0.031	-0.008	-0.463	-0.315
3.9	-0.809	0.253	3.234	0.685	0.030	-0.008	-0.472	-0.303
4.0	-0.800	0.278	3.145	0.555	0.029	-0.007	-0.481	-0.290
4.1	-0.790	0.300	2.998	0.449	0.028	-0.007	-0.490	-0.273
4.2	-0.780	0.321	2.798	0.370	0.026	-0.006	-0.498	-0.255
4.3	-0.770	0.341	2.800	0.349	0.023	-0.005	-0.506	-0.237
4.4	-0.759	0.360	2.798	0.363	0.020	-0.004	-0.513	-0.218
4.5	-0.746	0.379	2.789	0.430	0.016	-0.003	-0.520	-0.201
4.6	-0.733	0.400	2.759	0.590	0.012	-0.002	-0.527	-0.186
4.7	-0.720	0.421	2.652	0.962	0.008	-0.001	-0.534	-0.172
4.8	-0.706	0.443	2.054	1.934	0.003	0.000	-0.540	-0.160
4.9	-0.693	0.464	-0.806	2.704	-0.002	0.001	-0.547	-0.150
5.0	-0.681	0.486	-2.262	1.685	-0.007	0.002	-0.553	-0.139
5.1	-0.671	0.507	-2.554	1.198	-0.012	0.002	-0.559	-0.130
5.2	-0.657	0.528	-2.647	0.975	-0.018	0.003	-0.565	-0.120
5.3	-0.638	0.551	-2.687	0.860	-0.022	0.003	-0.571	-0.111
5.4	-0.609	0.576	-2.703	0.805	-0.027	0.003	-0.577	-0.101
5.5	-0.566	0.605	-2.705	0.798	-0.031	0.002	-0.582	-0.092
5.6	-0.512	0.634	-2.692	0.842	-0.033	0.002	-0.588	-0.082
5.7	-0.464	0.657	-2.653	0.957	-0.035	0.002	-0.593	-0.072
5.8	-0.389	0.687	-2.562	1.184	-0.036	0.003	-0.597	-0.061
5.9	-0.295	0.709	-2.203	1.485	-0.035	0.003	-0.601	-0.049
6.0	-0.168	0.688	-1.649	1.944	-0.032	0.005	-0.605	-0.037

The data was taken in a package fixture. The reference planes are at the package interface.

T1G6000528-Q3

7W, 28V, DC – 6 GHz, GaN RF Power Transistor



Device Characterization Data

Load-Pull Data

Test conditions: $V_{DD} = 28\text{ V}$, $I_{DQ} = 50\text{ mA}$, Test signal = CW

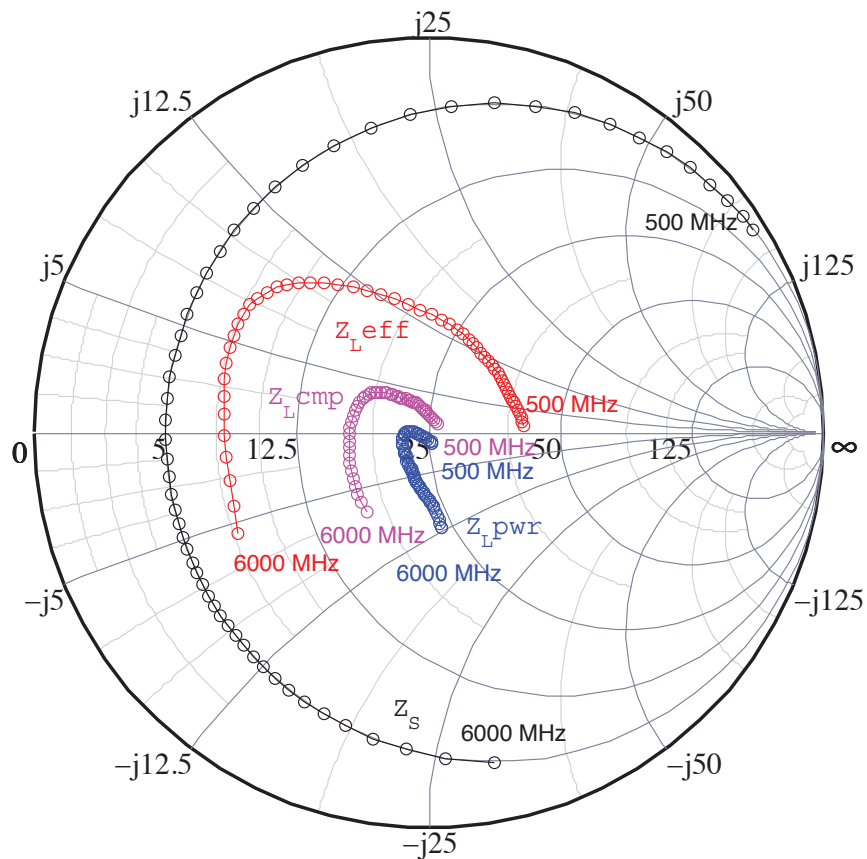

T1G6000528-Q3

7W, 28V, DC – 6 GHz, GaN RF Power Transistor



Load-Pull Data

RF performance that the device typically exhibits when placed in the specified impedance environment. The impedances are not the impedances of the device, they are the impedances presented to the device via an RF circuit or load-pull system. The impedances listed follow an optimized trajectory to maintain high power and high efficiency (ZLcmp). Test conditions: $V_{DS}=28V$, $I_{DQ}=50mA$

Freq. [MHz]	Real(ZS)	Imag(ZS)	Real(ZL)	Imag(ZL)	G3dB [dB]	P3dB [dBm]	P3dB [W]	PAE @3dB[%]
500	5.00	86.68	26.11	1.23	17.8	38.8	7.6	54.0
600	5.00	80.16	25.94	1.34	17.9	38.9	7.7	54.4
700	5.00	72.72	25.77	1.47	17.9	38.9	7.8	54.8
800	5.00	65.74	25.62	1.59	18.0	39.0	7.9	55.2
900	5.00	59.41	25.46	1.73	18.0	39.0	8.0	55.6
1000	5.00	53.61	25.31	1.87	18.1	39.1	8.1	56.0
1100	5.00	48.21	25.16	2.01	18.1	39.3	8.6	57.4
1200	5.00	43.15	25.01	2.15	18.2	39.6	9.1	58.8
1300	5.00	38.42	24.86	2.29	18.2	39.8	9.6	60.2
1400	5.00	34.02	24.71	2.43	18.3	40.1	10.1	61.6
1500	5.00	29.98	24.55	2.57	18.3	40.3	10.7	63.0
1600	5.00	26.32	24.40	2.71	18.3	40.5	11.3	64.4
1700	5.00	23.05	24.23	2.84	18.4	40.8	12.0	65.8
1800	5.00	20.16	24.06	2.97	18.4	41.0	12.6	67.2
1900	5.00	17.62	23.89	3.09	18.5	41.3	13.4	68.6
2000	5.00	15.40	23.71	3.20	18.5	41.5	14.1	70.0
2100	5.00	13.46	23.52	3.31	18.2	41.5	14.0	68.6
2200	5.00	11.77	23.32	3.40	17.8	41.4	13.8	67.2
2300	5.00	10.29	23.11	3.49	17.5	41.4	13.6	65.8
2400	5.00	8.97	22.90	3.56	17.1	41.3	13.5	64.4
2500	5.00	7.78	22.67	3.62	16.8	41.3	13.3	63.0
2600	5.00	6.66	22.43	3.68	16.4	41.2	13.2	61.6
2700	5.00	5.60	22.18	3.73	16.1	41.2	13.0	60.2
2800	5.00	4.56	21.93	3.77	15.7	41.1	12.9	58.8
2900	5.00	3.55	21.66	3.81	15.4	41.1	12.7	57.4
3000	5.00	2.54	21.38	3.85	15.0	41.0	12.6	56.0
3100	5.00	1.55	21.09	3.88	14.9	41.0	12.5	56.6
3200	5.00	0.59	20.79	3.92	14.8	41.0	12.5	57.2
3300	5.00	-0.33	20.48	3.97	14.8	40.9	12.4	57.8
3400	5.00	-1.20	20.16	4.01	14.7	40.9	12.4	58.4
3500	5.00	-2.03	19.84	4.04	14.6	40.9	12.3	59.0
3600	5.00	-2.80	19.52	4.06	14.5	40.9	12.2	59.6
3700	5.00	-3.53	19.20	4.05	14.4	40.9	12.2	60.2
3800	5.00	-4.23	18.89	4.00	14.4	40.8	12.1	60.8
3900	5.00	-4.89	18.60	3.93	14.3	40.8	12.1	61.4
4000	5.00	-5.52	18.32	3.80	14.2	40.8	12.0	62.0
4100	5.00	-6.14	18.06	3.63	14.0	40.8	11.9	62.0
4200	5.00	-6.74	17.82	3.40	13.9	40.7	11.8	62.0
4300	5.00	-7.33	17.60	3.11	13.7	40.7	11.7	62.0
4400	5.00	-7.93	17.40	2.77	13.6	40.6	11.6	62.0
4500	5.00	-8.52	17.23	2.38	13.4	40.6	11.5	62.0
4600	5.00	-9.11	17.07	1.95	13.2	40.6	11.4	62.0
4700	5.00	-9.73	16.93	1.48	13.1	40.5	11.3	62.0
4800	5.00	-10.36	16.82	0.97	12.9	40.5	11.2	62.0
4900	5.00	-11.03	16.71	0.43	12.8	40.4	11.1	62.0
5000	5.00	-11.75	16.63	-0.14	12.6	40.4	11.0	62.0
5100	5.00	-12.54	16.57	-0.73	12.5	40.4	11.0	61.7
5200	5.00	-13.41	16.52	-1.36	12.4	40.4	11.0	61.4
5300	5.00	-14.39	16.49	-2.00	12.3	40.4	11.0	61.1
5400	5.00	-15.52	16.48	-2.67	12.2	40.4	11.0	60.8
5500	5.00	-16.84	16.50	-3.36	12.1	40.4	11.0	60.5
5600	5.00	-18.43	16.53	-4.08	11.9	40.4	11.0	60.2
5700	5.00	-20.37	16.59	-4.82	11.8	40.4	11.0	59.9
5800	5.00	-22.78	16.68	-5.58	11.7	40.4	11.0	59.6
5900	5.00	-25.88	16.80	-6.37	11.6	40.4	11.0	59.3
6000	5.00	-29.97	16.95	-7.19	11.5	40.4	11.0	59.0

T1G6000528-Q3

7W, 28V, DC – 6 GHz, GaN RF Power Transistor



Typical Performance: Gain, Efficiency and Output Power

Performance is measured at DUT reference plane

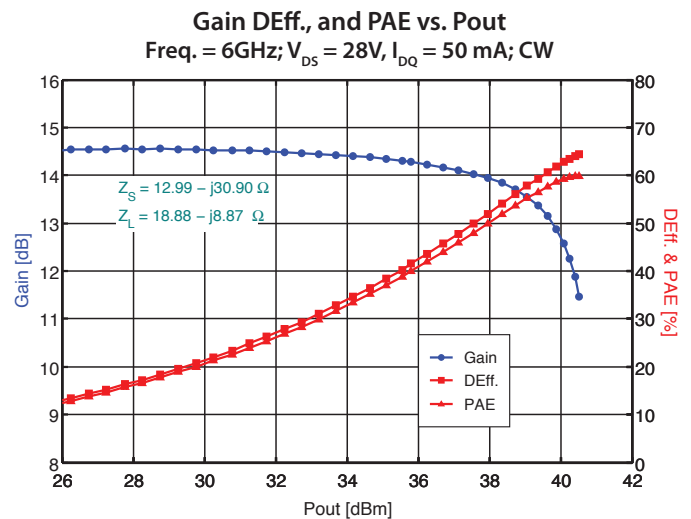
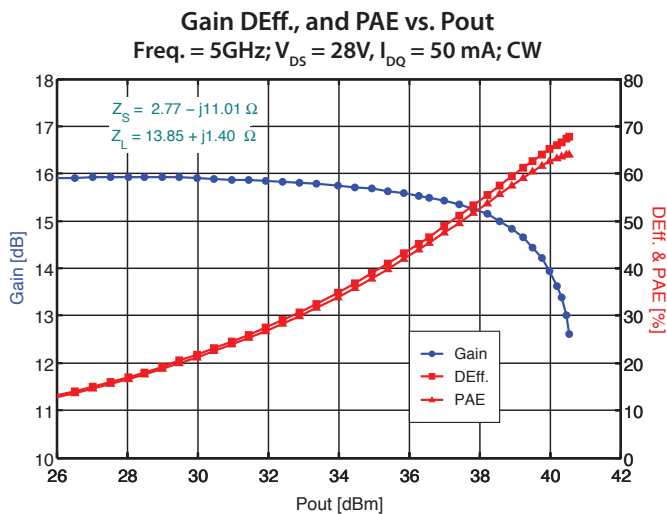
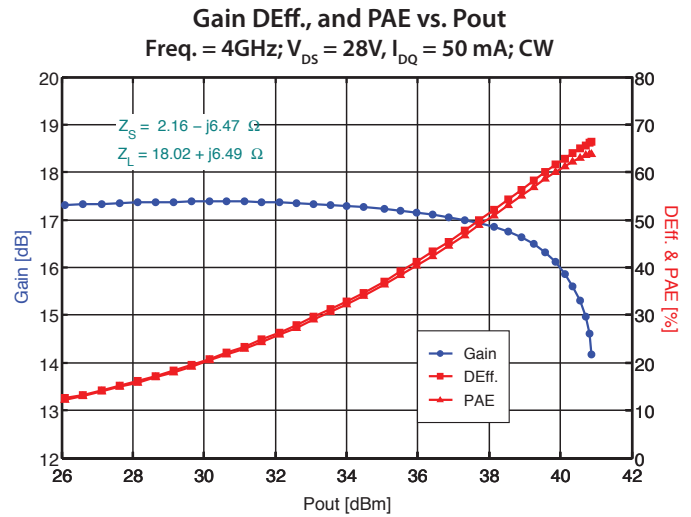
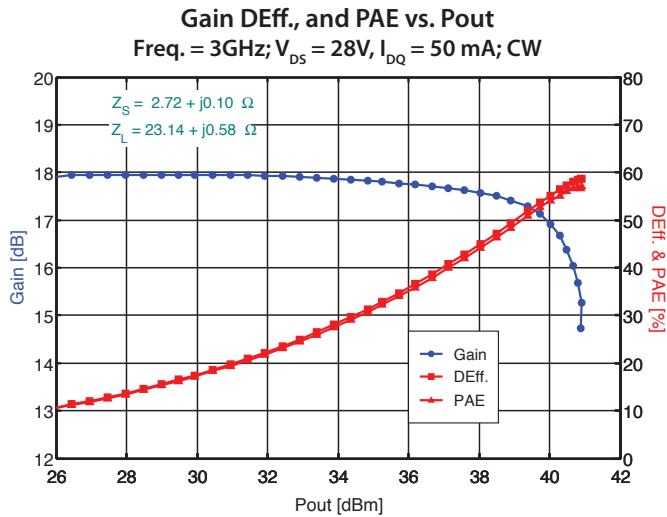

T1G6000528-Q3

7W, 28V, DC – 6 GHz, GaN RF Power Transistor



Performance Over Temperature: Gain, Efficiency and Output Power

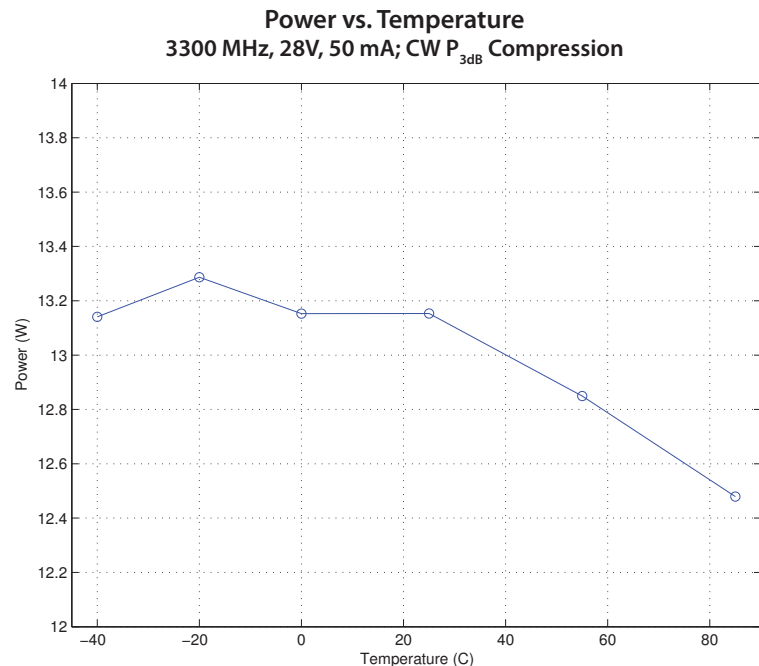
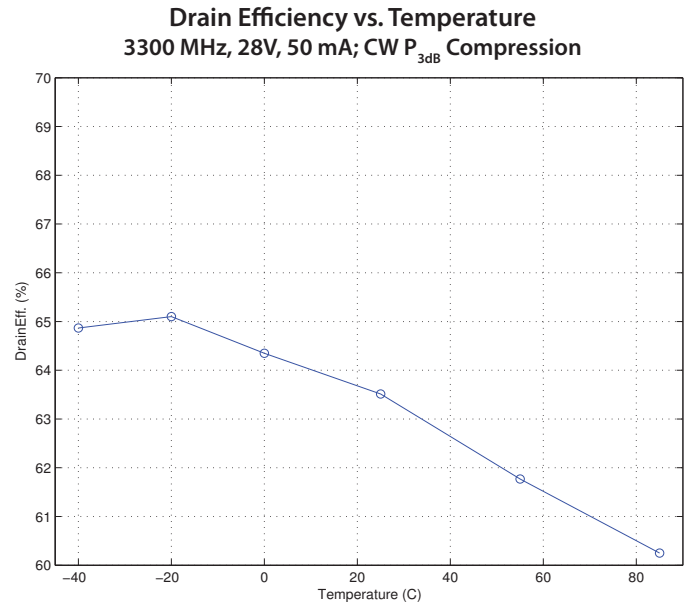
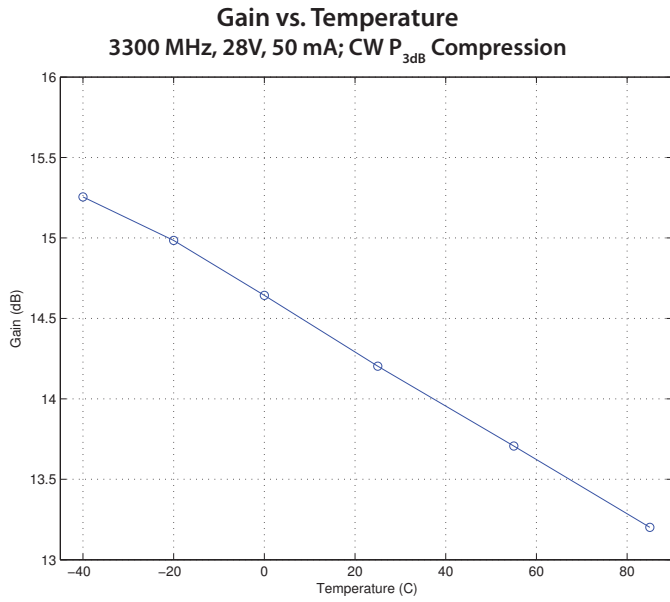

T1G6000528-Q3

7W, 28V, DC – 6 GHz, GaN RF Power Transistor



Evaluation Board Performance: 3.0 to 3.5 GHz

T1G6000528-Q3 P3dB Compression in Narrowband Fixture
28V, 50mA; 200µsec – 20% duty-cycle pulse

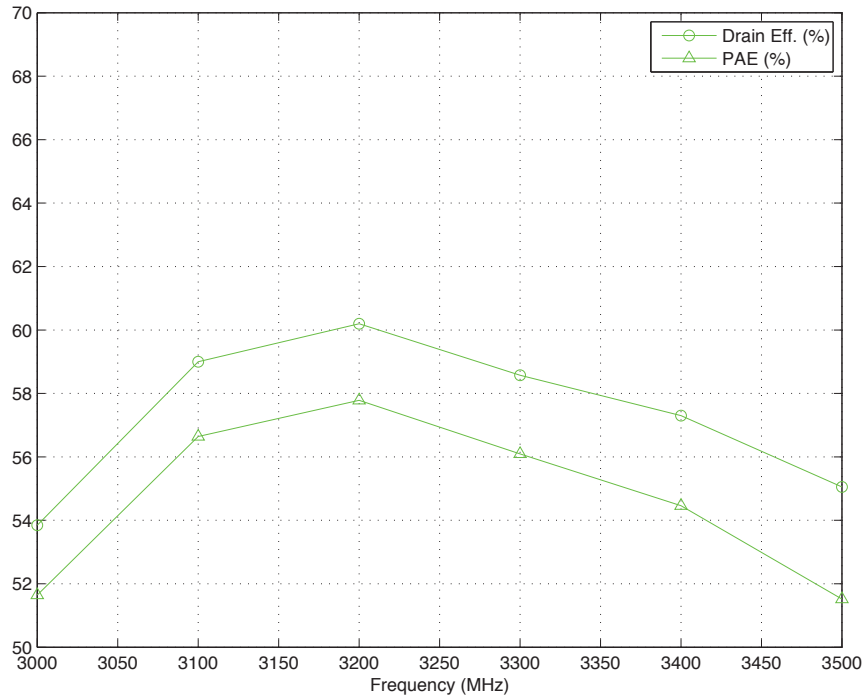

T1G6000528-Q3 P3dB Compression in Narrowband Fixture
28V, 50mA; 200µsec – 20% duty-cycle pulse

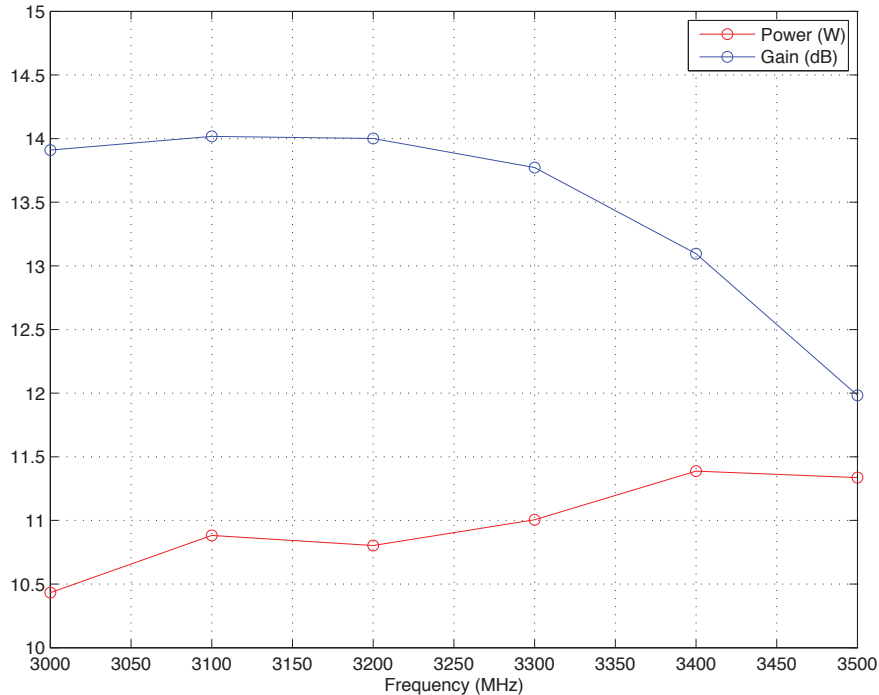

T1G6000528-Q3

7W, 28V, DC – 6 GHz, GaN RF Power Transistor



Evaluation Board Information

PC Board Layout: T1G6000528-Q3-EVB3, 3.0 to 3.5 GHz

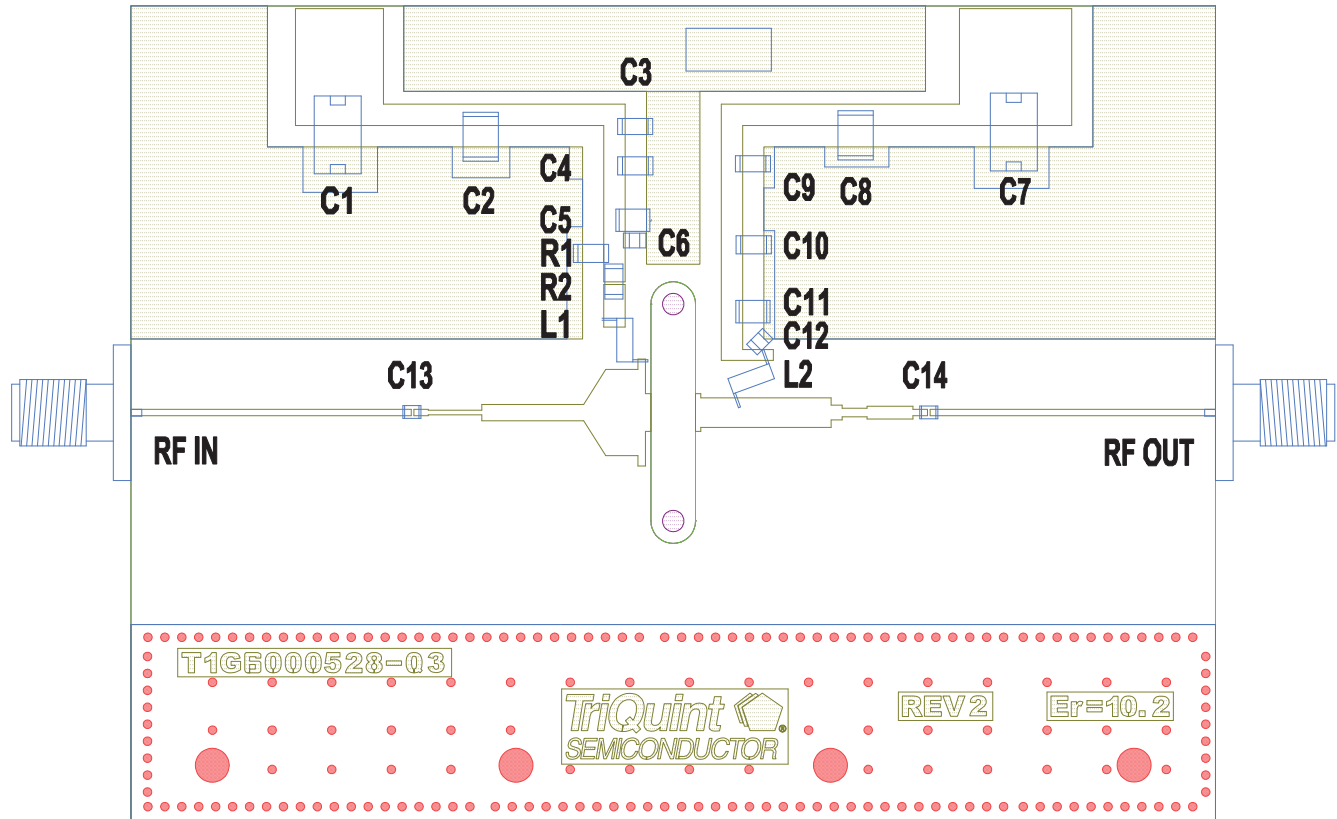

Bill of Materials

Reference Desg.	Value	Manufacturer	Part Number	Reference Desg.	Value	Manufacturer	Part Number
C1	22 uF	Sprague	T491D	C9	0.1 uF	Kemet	C1206C104KRAC7800
C2	1 uF	Kemet	1812C105KAT2A	C10	.01 uF	Kemet	C1206C103KRAC7800
C3	0.1 uG	Kemet	C1206C104KRAC7800	C11	100 pF	ATC	100B101
C4	.01 uF	Kemet	C1206C103KRAC7800	C12	2400 pF	DLI	C08BL242X5UNX0B
C5	100 pF	ATC	100B101	L2	9.85 nH	Coilcraft	16069JLB
C6	2400 pF	DLI	C08BL242X5UNX0B	C13	27 pF	ATC	600L270JT200
R1	1000 ohm	Vishay Dale	CRCW08051001F100	C14	27 pF	ATC	600L270JT200
R2	12 ohm	Vishay Dale	RM73B2B120J	PCB	RO3210	Rogers	$\epsilon_r=10.2$ h=25 mil
L1	9.85 nH	Coilcraft	16069JLB	IMN			distributed transmission line input network
C7	22 uF	Sprague	T491D	OMN			distributed transmission line output network
C8	1 uF	Kemet	1812C105KAT2A				

T1G6000528-Q3

7W, 28V, DC – 6 GHz, GaN RF Power Transistor



Evaluation Board Information (Continued)

PC Board Schematic: T1G6000528-Q3-EVB3, 3.0 to 3.5 GHz

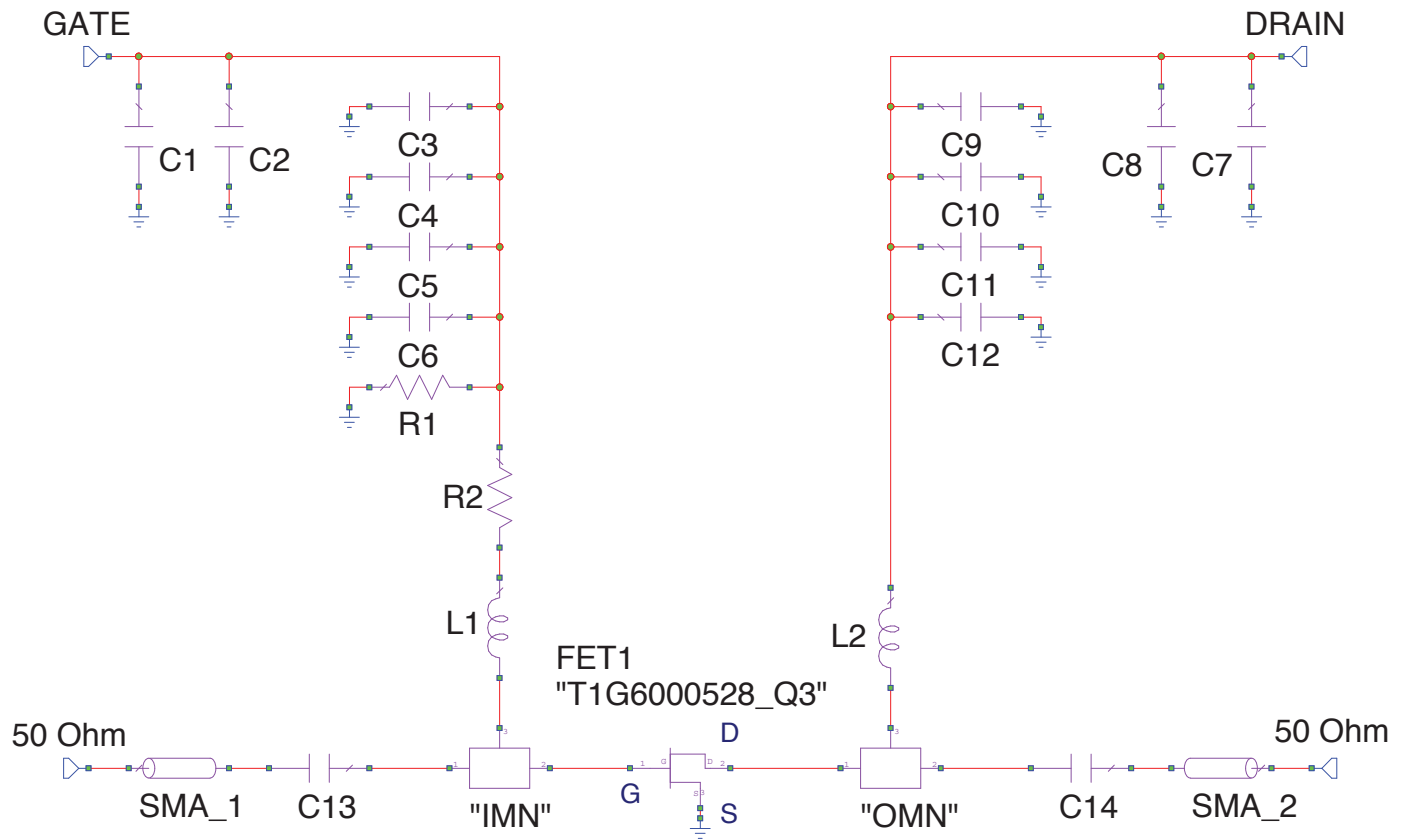

Bias-up Procedure	Bias-down Procedure
Set gate voltage (Vg) to -5.0 V	Turn off RF signal
Set drain voltage (Vd) to 28 V	Turn off Vd and wait 1 second to allow drain capacitor(s) to dissipate
Slowly increase Vg until quiescent Id is 50 mA. Typical Vg is -3.9 V	Turn off Vg
Apply RF signal	

T1G6000528-Q3

7W, 28V, DC – 6 GHz, GaN RF Power Transistor



Mechanical Information

Package Information and Dimensions

This package is lead-free/ROHS-compliant.

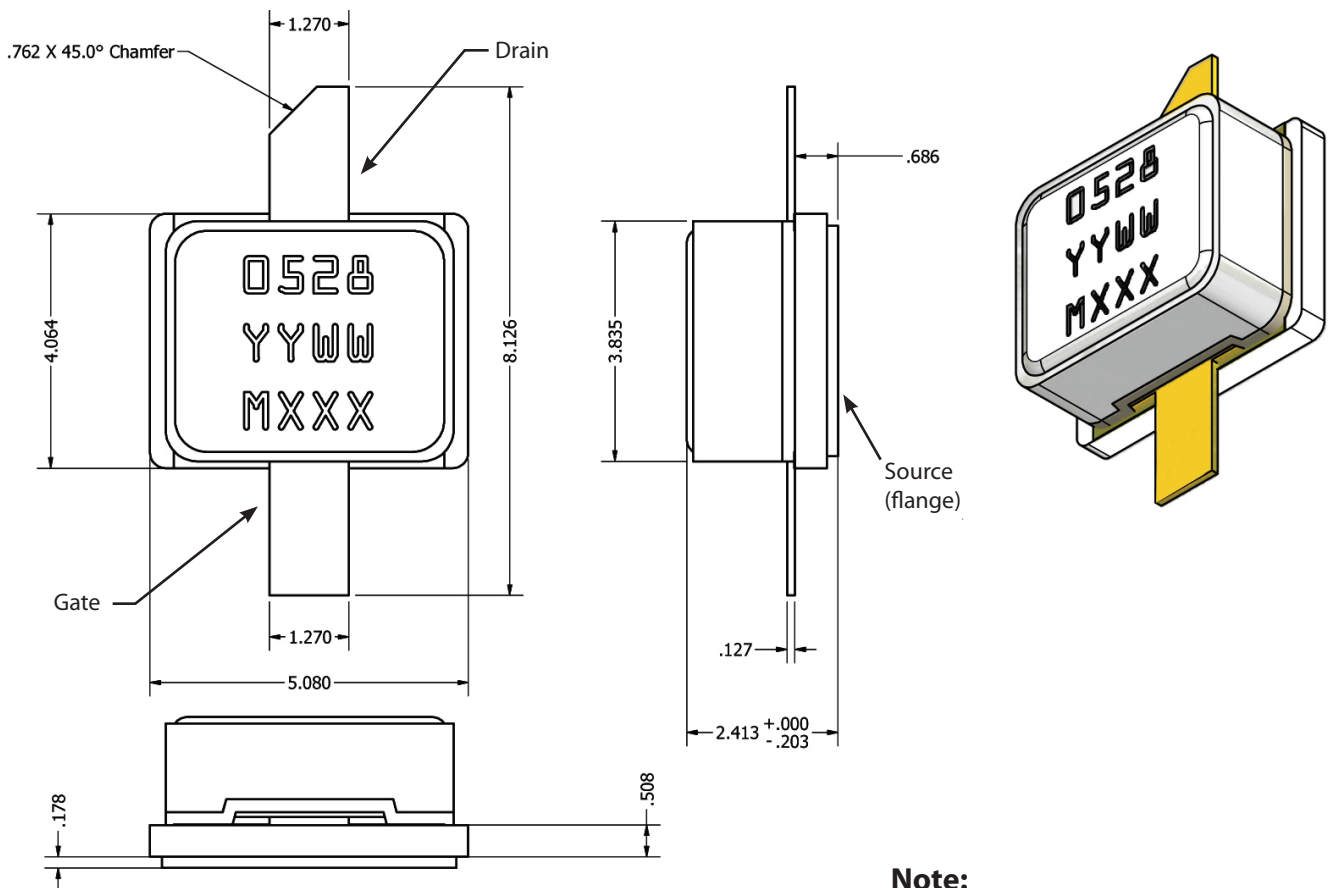

Note:
Unless specified otherwise,
dimensions are in millimeters

T1G6000528-Q3

7W, 28V, DC – 6 GHz, GaN RF Power Transistor

Product Compliance Information

ESD Information



Caution! ESD-Sensitive Device

ESD Rating: 1A

Value: Passes ≥ 250 V min.

Test: Human Body Model (HBM)

Standard: JEDEC Standard JESD22-A114

MSL Rating

Level 3 at +260 °C convection reflow.

The part is rated Moisture Sensitivity Level 3 at 260°C per JEDEC standard IPC/JEDEC J-STD-020.

ECCN

U.S. Department of Commerce EAR99

T1G6000528-Q3

7W, 28V, DC – 6 GHz, GaN RF Power Transistor



Contact Information

For the latest specifications, additional product information, worldwide sales and distribution locations, and information about TriQuint:

Web: www.triquint.com

Important Notice

The information contained herein is believed to be reliable. TriQuint makes no warranties regarding the information contained herein. TriQuint assumes no responsibility or liability whatsoever for any of the information contained herein. TriQuint assumes no responsibility or liability whatsoever for the use of the information contained herein. The information contained herein is provided "AS IS, WHERE IS" and with all faults, and the entire risk associated with such information is entirely with the user. All information contained herein is subject to change without notice. Customers should obtain and verify the latest relevant information before placing orders for TriQuint products. The information contained herein or any use of such information does not grant, explicitly or implicitly, to any party any patent rights, licenses, or any other intellectual property rights, whether with regard to such information itself or anything described by such information.

TriQuint products are not warranted or authorized for use as critical components in medical, life-saving, or life-sustaining applications, or other applications where a failure would reasonably be expected to cause severe personal injury or death.