



FEATURES:

- AC-DC Constant Current or Constant Voltage LED Driver
- Input range 90-305VAC/47-440Hz
- High efficiency up to 86%
- Operating temperature -40 to 85°C
- Dimmable via analog / 0-10V dimming ^②
- Over temperature protection
- Over current protection
- Waterproof case rated IP68
- Power Factor Correction
- Short circuit protection



Models Single output

Model	Output Voltage Range (V) ^③	Output Current (A) ^③	Input Voltage (VAC/Hz)	Input Voltage (VDC)	Mode of Operation	Max Output Power (W) ^①	Efficiency (%)
AMEPR30-5070AZ	36-50	0-0.77	90-305/47-440	120-430	Constant Current	35	86
					Constant Voltage ^②	38.5	85
AMEPR30-4864AZ	36-48	0-0.66	90-305/47-440	120-430	Constant Current	30.7	86
					Constant Voltage ^②	31.7	84
AMEPR30-36100AZ	24-36	0-1.04	90-305/47-440	120-430	Constant Current	36	85
					Constant Voltage ^②	37.4	84
AMEPR30-24140AZ	12-24	0-1.45	90-305/47-440	120-430	Constant Current	33.6	84
					Constant Voltage ^②	34.8	84
AMEPR30-12250AZ	5-12	0-2.55	90-305/47-440	120-430	Constant Current	30	83
					Constant Voltage ^②	30.6	83

^① Exceeding the maximum output power will permanently damage the converter

^② The dimming feature is not supported when units are used in Constant Voltage mode only.

^③ In constant current mode output current is maximum shown, in constant voltage mode output voltage is the maximum shown.

NOTE: All specifications in this datasheet are measured at an ambient temperature of 25°C, humidity<75%, nominal input voltage and at rated output load unless otherwise specified.

Input Specifications

Parameters	Conditions	Typical	Maximum	Units
Inrush current <2ms	115VAC	25		A
	230VAC	40		
Leakage current	115VAC	0.3		mA
	230VAC	0.5		
AC current	115VAC	0.43		A
	230VAC	0.25		
Power Factor	115VAC		0.96	
	230VAC		0.90	
External fuse			250V/1A	
Start up time		450		ms

Output Specifications

Parameters	Conditions	Typical	Maximum	Units
Current accuracy		±2		%
Line regulation	LL-HL	±1		%
Load regulation	0-100% load	±2		%
Ripple & Noise ^④	20MHz Bandwidth	75		mV p-p
Hold-up time		50		ms
Current adjustment range		100-0		%
Minimum Load Voltage	See the models table			

^④ Tested with 0.1µF (C/C) or (M/C) and 47µF (E/C) parallel capacitors at the end.

Isolation Specifications

Parameters	Conditions	Typical	Rated	Units
Tested I/O voltage	3sec		3000	VAC
Isolation Resistance	500VDC	>1000		MΩ
Isolation Capacitance		1000		pF

General Specifications

Parameters	Conditions	Typical	Maximum	Units
Switching frequency		130		KHz
Over current protection		95-110% of Iout		
Over voltage protection		110% of Vout		
Short circuit protection		Continuous		
Short circuit restart		Auto recovery		
Over temperature protection		>105°C		
Operating temperature	With derating over 55°C	-40 to +85		°C
Maximum case temperature			100	°C
Storage temperature		-40 to +95		°C
Temperature coefficient		±0.02		% / °C
Cooling		Free air convection		
Humidity			95	% RH
Case material		Plastic		
Potting		Epoxy (IP67 rated)		
Wires		UL1015 18AWG * 20CM		
Weight		350		g
Dimensions		5.30 x 2.27 x 1.59 inches 134.80 x 57.68 x 40.50 mm		
MTBF		>400,000 hrs (MIL-HDBK-217F at +25°C)		

Safety Specifications

Parameters		
Agency approvals	cULus, CE	
Standards	UL8750, UL60950-1, EN55022, class B, EN60529(IP68), EN61347-1, EN61347-2-13	
	Information Technology Equipment	EN55022 Class B
	Harmonic Current Emissions	IEC/EN 61000-3-2, Class C
	Voltage fluctuations and flicker	IEC/EN 61000-3-3, (EN60555-3)
	Electrostatic Discharge Immunity	IEC 61000-4-2
	RF, Electromagnetic Field Immunity	IEC 61000-4-3
	Electrical Fast Transient / Burst Immunity	IEC 61000-4-4
	Surge Immunity	IEC 61000-4-5
	RF, Conducted Disturbance Immunity	IEC 61000-4-6
	Power frequency Magnetic Field Immunity	IEC 61000-4-8
	Voltage dips, Short Interruptions Immunity	IEC 61000-4-11

Dimensions

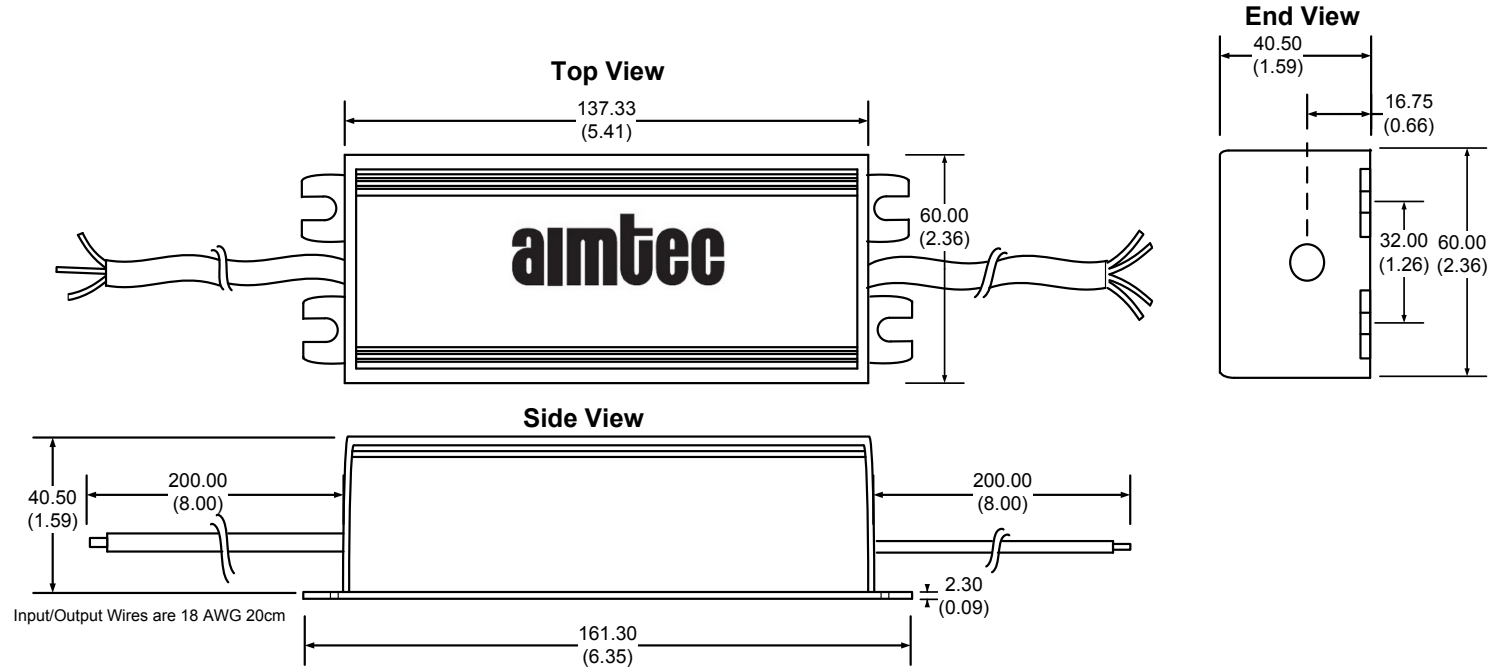

NOTE: to adjust the output current connect a 20K Ohm pot between blue and white wire

Analog (Resistive) Dimming Application Circuit

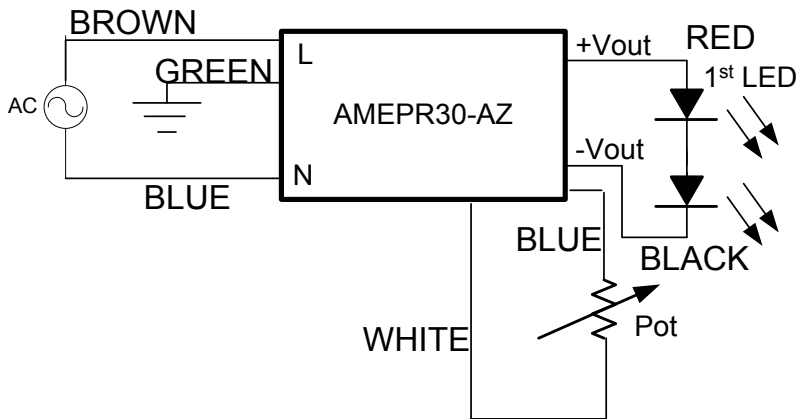

Model Number	Maximum Pot Value (kΩ)
AMEPR30-5070AZ	9.00
AMEPR30-4864AZ	9.00
AMEPR30-36100AZ	9.00
AMEPR30-24140AZ	26.00
AMEPR30-12250AZ	26.10

0-10V Dimming Application Circuit

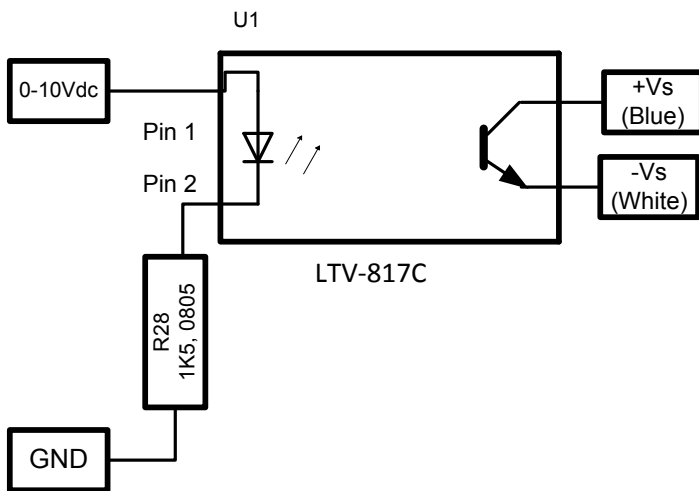

Derating

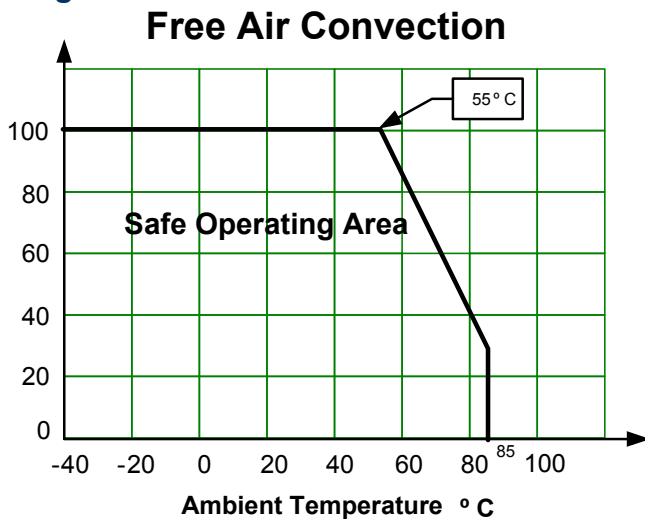

Efficiency Vs. Input Voltage & Output Current (Constant Current Mode)

AMEPR30-5070AZ

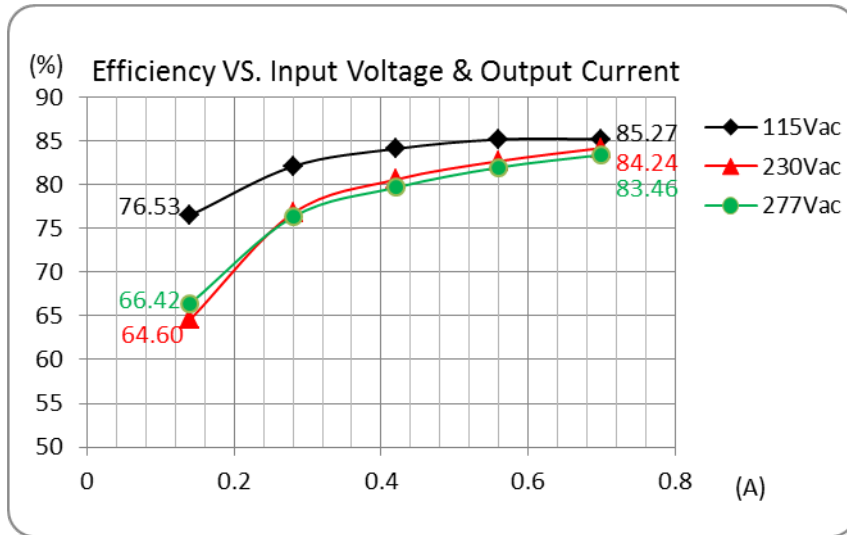

AMEPR30-4864AZ

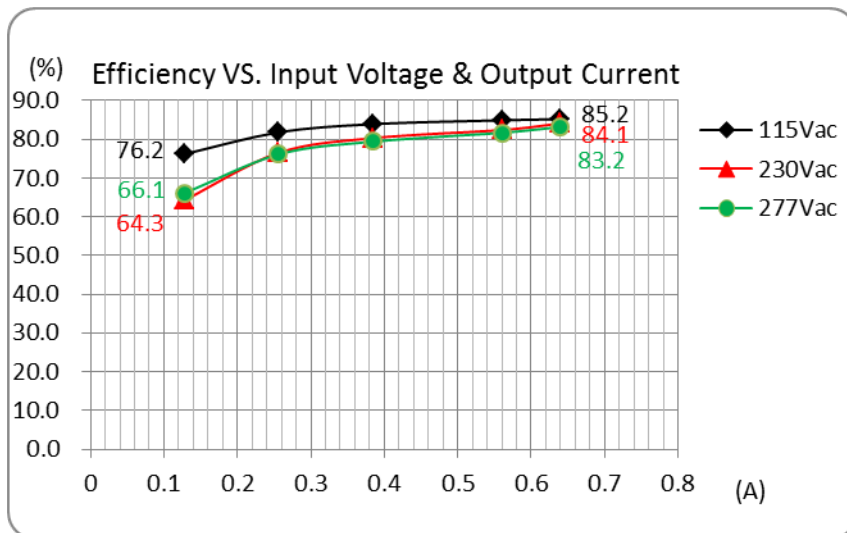

**Efficiency Vs. Input Voltage & Output Current (Constant Current Mode)
Continued**

AMEPR30-36100AZ

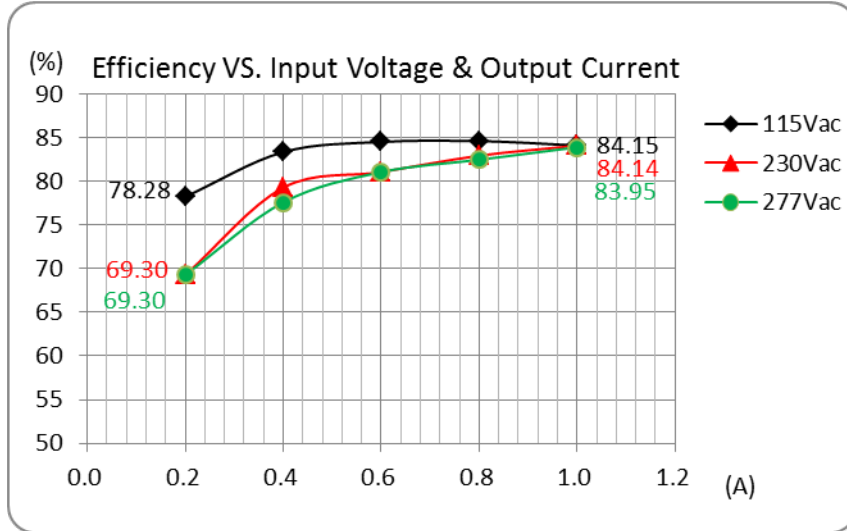

AMEPR30-24140AZ

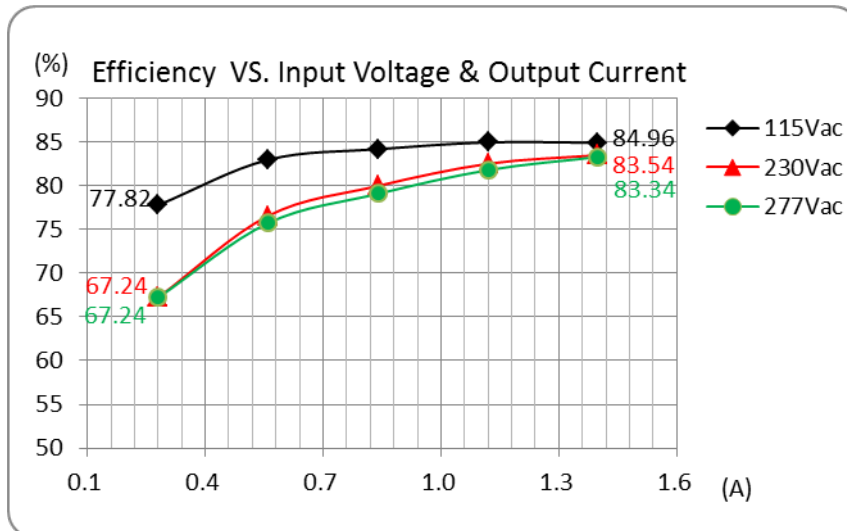

**Efficiency Vs. Input Voltage & Output Current (Constant Current Mode)
Continued**

AMEPR30-12250AZ

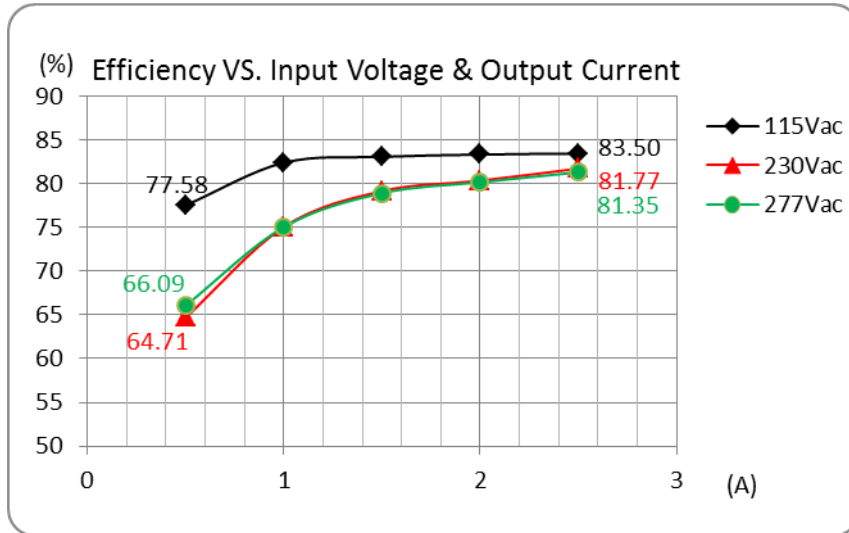

PFC Value vs. Output Load Current (Constant Current Mode)

AMEPR30-5070AZ

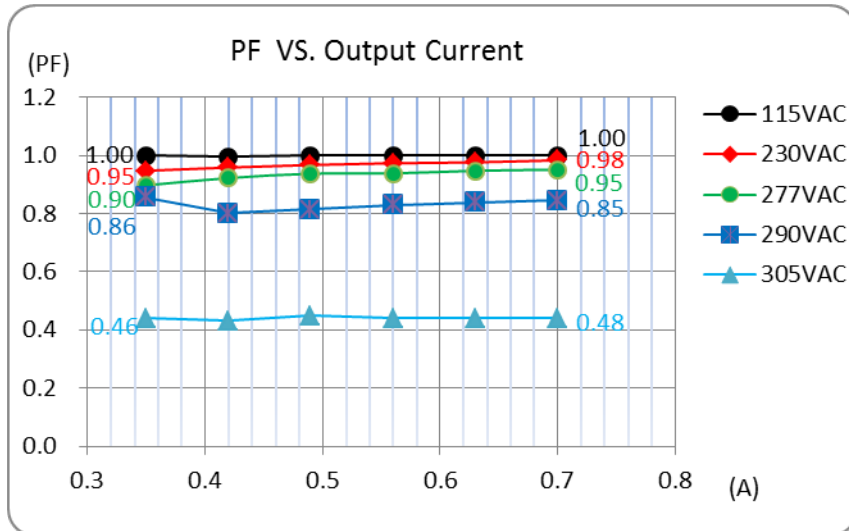

**PFC Value vs. Output Load Current (Constant Current Mode)
Continued**

AMEPR30-4864AZ

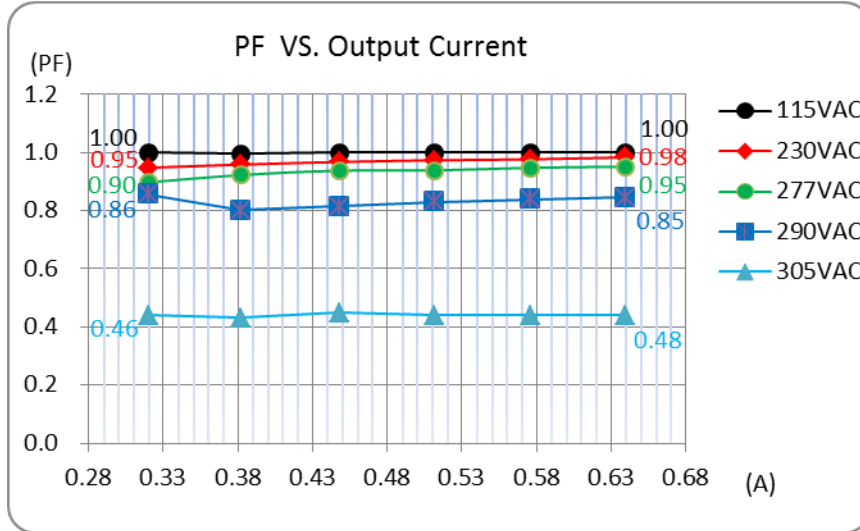

AMEPR30-36100AZ

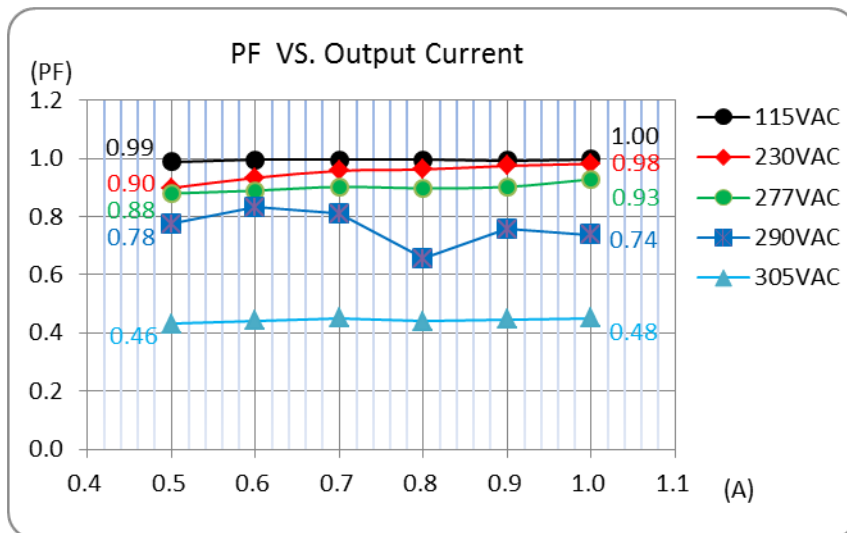

**PFC Value vs. Output Load Current (constant current mode)
Continued**

AMEPR30-24140AZ

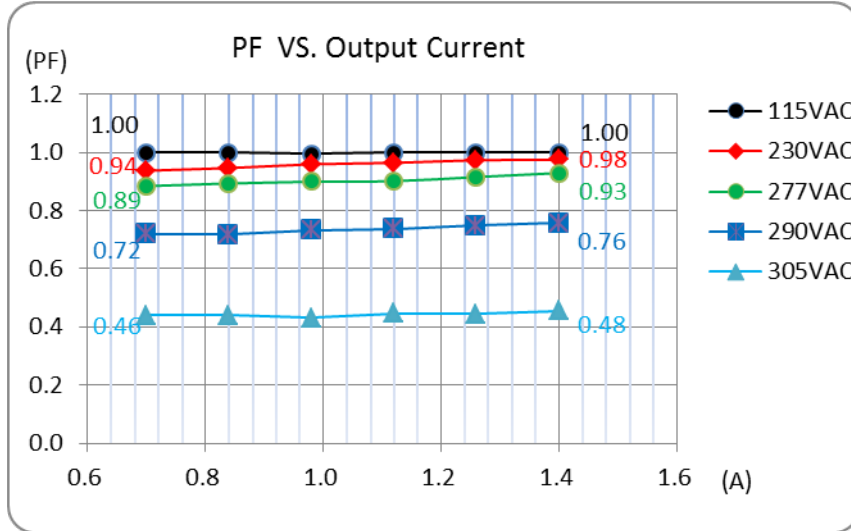

AMEPR30-12250AZ

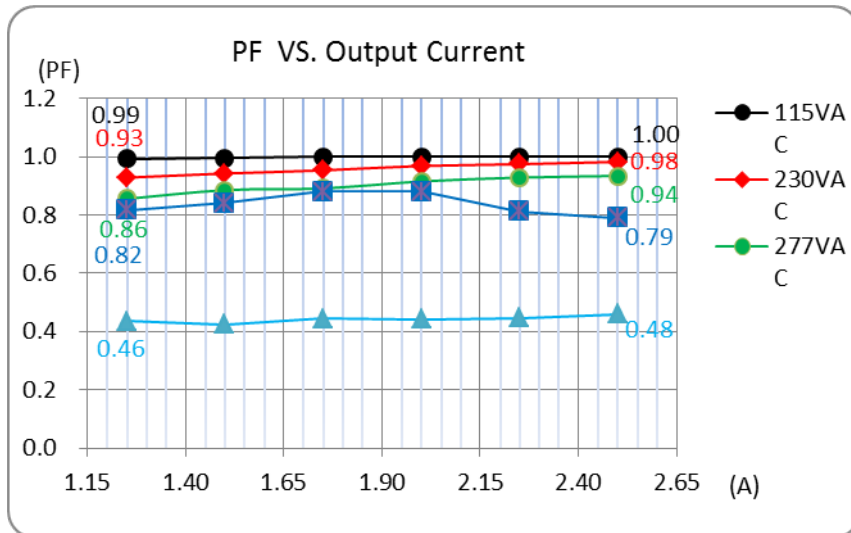

Constant Current vs. Constant Voltage Mode

AMEPR30-5070AZ

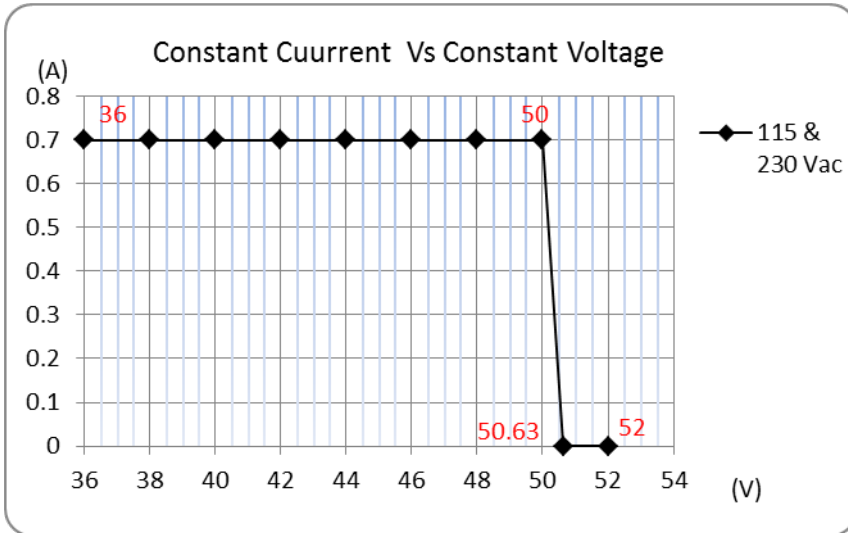

AMEPR30-4864AZ

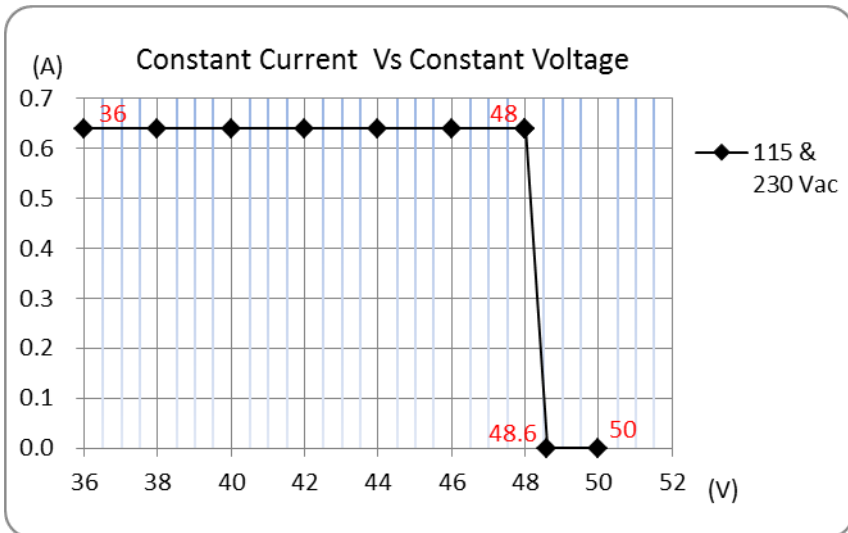

Constant Current vs. Constant Voltage Mode (continued)

AMEPR30-36100AZ

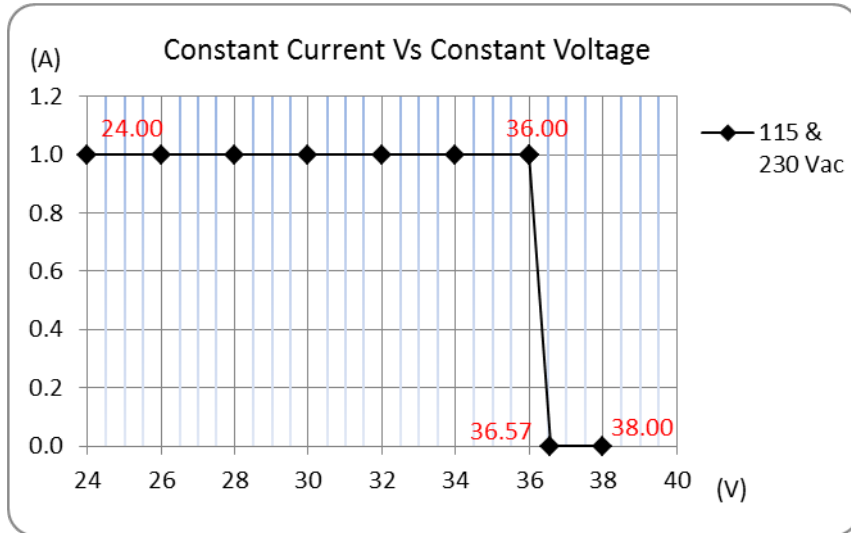

AMEPR30-24140AZ

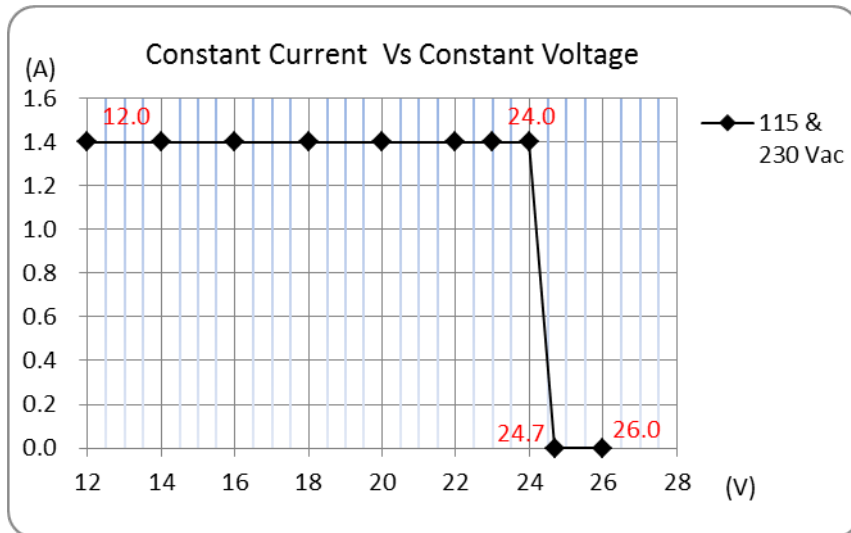

Constant Current vs. Constant Voltage Mode (continued)

AMEPR30-12250AZ

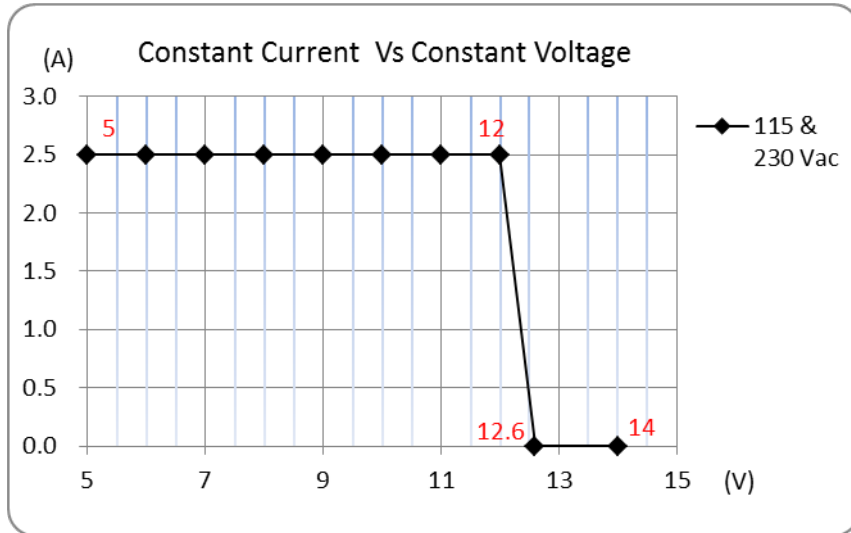

Dimming Control (Output Current vs. Radj)

AMEPR30-5070AZ

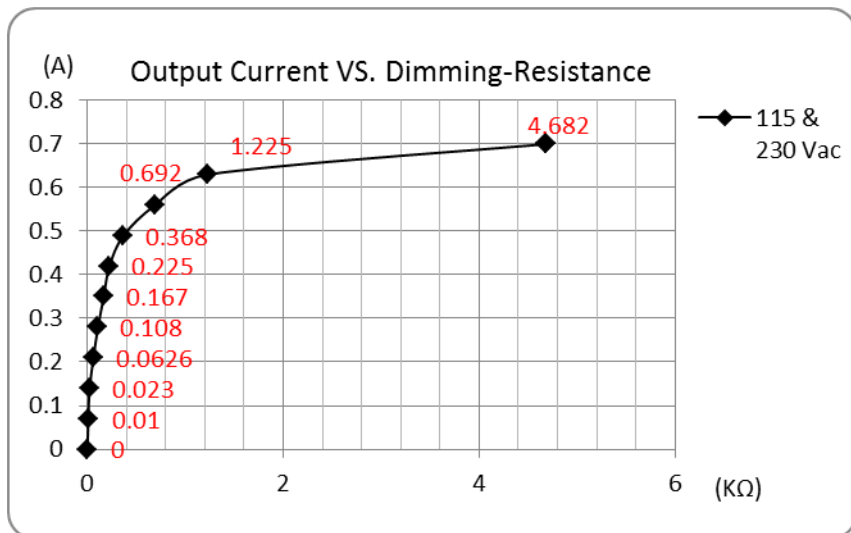

Dimming Control (Output Current vs. R_{adj}) continued

AMEPR30-4864AZ

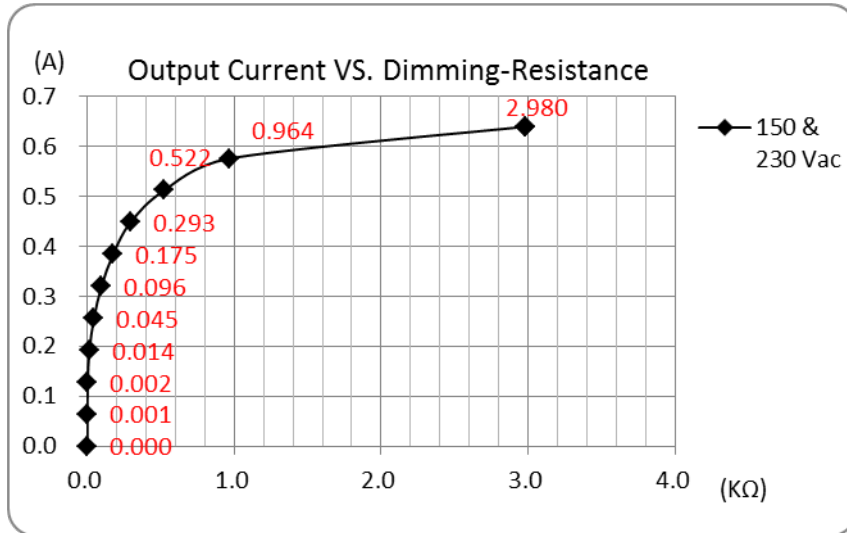

AMEPR30-36100AZ

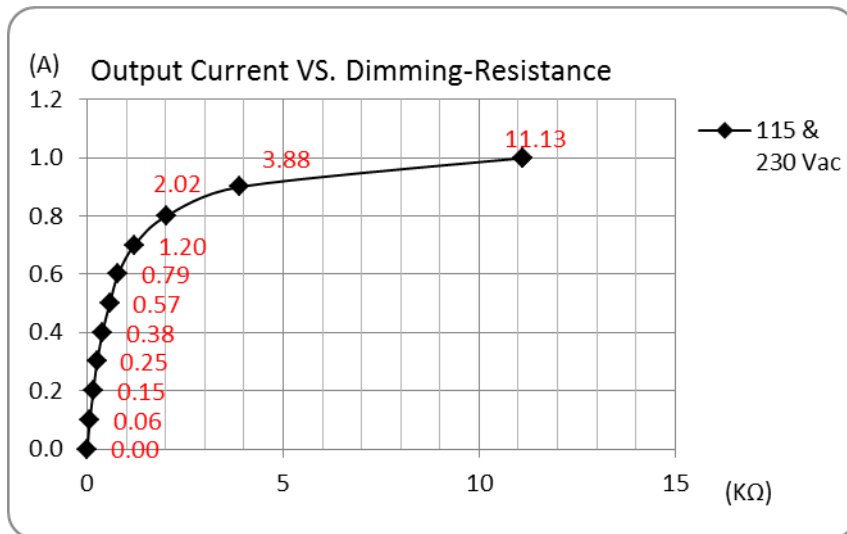

Dimming Control (Output Current vs. R_{adj}) continued

AMEPR30-24140AZ

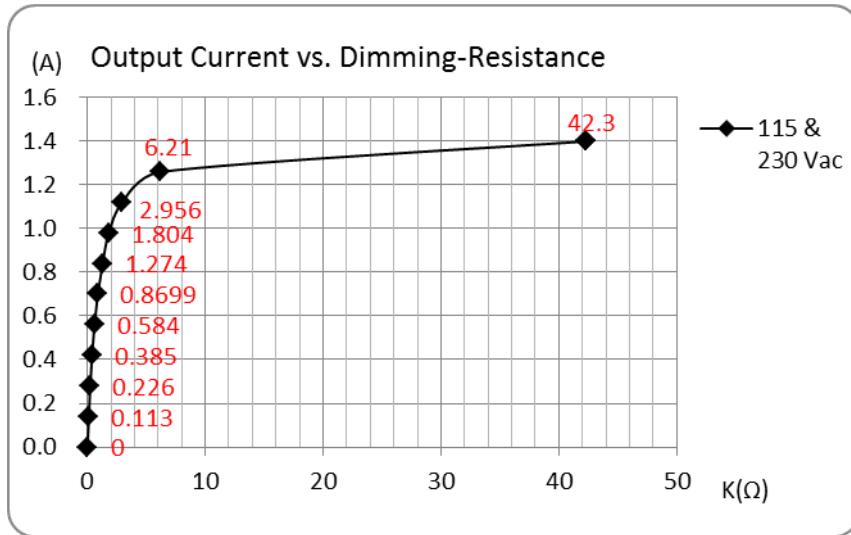

AMEPR30-12250AZ

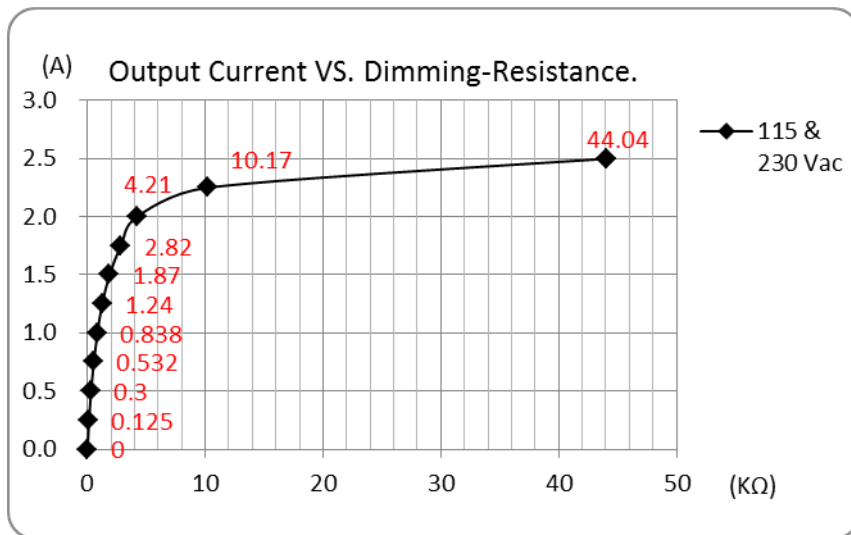

NOTE: 1. Datasheets are updated as needed and as such, specifications are subject to change without notice. Once printed or downloaded, datasheets are no longer controlled by Aimtec; refer to www.aimtec.com for the most current product specifications. 2. Product labels shown, including safety agency certifications on labels, may vary based on the date manufactured. 3. Mechanical drawings and specifications are for reference only. 4. All specifications are measured at an ambient temperature of 25°C, humidity<75%, nominal input voltage and at rated output load unless otherwise specified. 5. Aimtec may not have conducted destructive testing or chemical analysis on all internal components and chemicals at the time of publishing this document. CAS numbers and other limited information are considered proprietary and may not be available for release. 6. This product is not designed for use in critical life support systems, equipment used in hazardous environments, nuclear control systems or other such applications which necessitate specific safety and regulatory standards other the ones listed in this datasheet. 7. Warranty is in accordance with Aimtec's standard Terms of Sale available at www.aimtec.com.