



SANYO Semiconductors

DATA SHEET

An ON Semiconductor Company

2SA1706 — PNP Epitaxial Planar Silicon Transistor High-Current Switching Applications

Applications

- Voltage regulators, relay drivers, lamp drivers

Features

- Adoption of FBET, MBIT processes
- Large current capacity and wide ASO
- Fast switching speed

Specifications

Absolute Maximum Ratings at Ta=25°C

Parameter	Symbol	Conditions	Ratings	Unit
Collector-to-Base Voltage	V _{CBO}		-60	V
Collector-to-Emitter Voltage	V _{CEO}		-50	V
Emitter-to-Base Voltage	V _{EBO}		-6	V
Collector Current	I _C		-2	A
Collector Current (Pulse)	I _{CP}		-4	A
Collector Dissipation	PC		1	W
Junction Temperature	T _j		150	°C
Storage Temperature	T _{stg}		-55 to +150	°C

Package Dimensions

unit : mm (typ)

7540-001

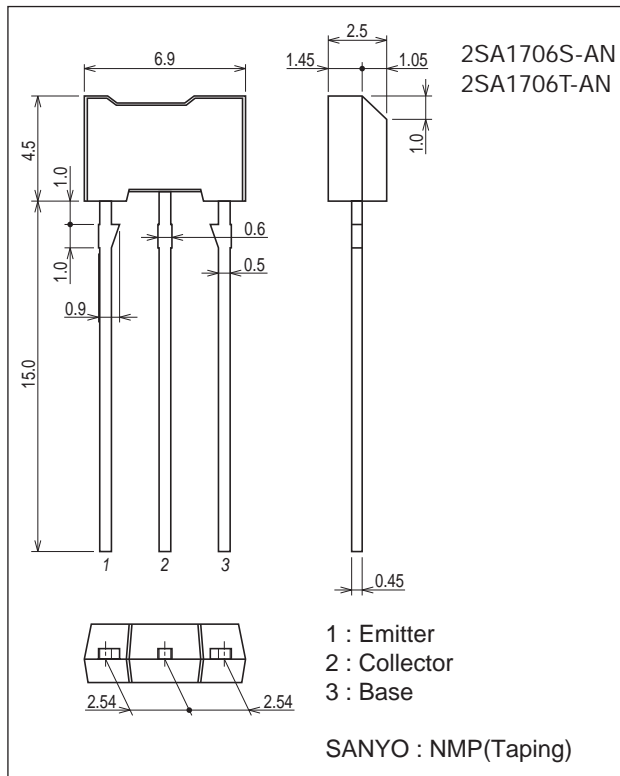

Product & Package Information

- Package : NMP(Taping)
- JEITA, JEDEC : SC-71
- Minimum Packing Quantity : 2,500 pcs./box

Marking(NMP(Taping))

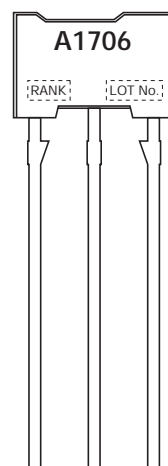

Electrical Connection

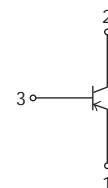

2SA1706

Electrical Characteristics at Ta=25°C

Parameter	Symbol	Conditions	Ratings			Unit
			min	typ	max	
Collector Cutoff Current	ICBO	V _{CB} =-50V, I _E =0A			-100	nA
Emitter Cutoff Current	I _{EBO}	V _{EB} =-4V, I _C =0A			-100	nA
DC Current Gain	h _{FE1}	V _{CE} =-2V, I _C =-100mA	140*		400*	
	h _{FE2}	V _{CE} =-2V, I _C =-1.5A	40			
Gain-Bandwidth Product	f _T	V _{CE} =-10V, I _C =-50mA		150		MHz
Collector-to-Emitter Saturation Voltage	V _{CE(sat)}	I _C =-1A, I _B =-50mA		-0.3	-0.7	V
Base-to-Emitter Saturation Voltage	V _{BE(sat)}	I _C =-1A, I _B =-50mA		-0.9	-1.2	V
Output Capacitance	C _{ob}	V _{CB} =-10V, f=1MHz		22		pF
Collector-to-Base Breakdown Voltage	V _{(BR)CBO}	I _C =-10μA, I _E =0A	-60			V
Collector-to-Emitter Breakdown Voltage	V _{(BR)CEO}	I _C =-1mA, R _{BE} =∞	-50			V
Emitter-to-Base Breakdown Voltage	V _{(BR)EBO}	I _E =-10μA, I _C =0A	-6			V
Turn-ON Time	t _{on}	See specified Test Circuit.		60		ns
Storage Time	t _{stg}			450		ns
Fall Time	t _f			30		ns

* : The 2SA1706 is classified by 100mA h_{FE} as follows :

Rank	S	T
h _{FE}	140 to 280	200 to 400

Switching Time Test Circuit

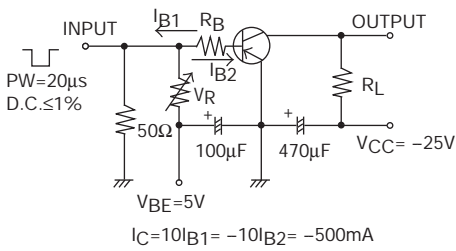

Ordering Information

Device	Package	Shipping	memo
2SA1706S-AN	NMP(Taping)	2,500pcs./box	Pb Free
2SA1706T-AN	NMP(Taping)	2,500pcs./box	

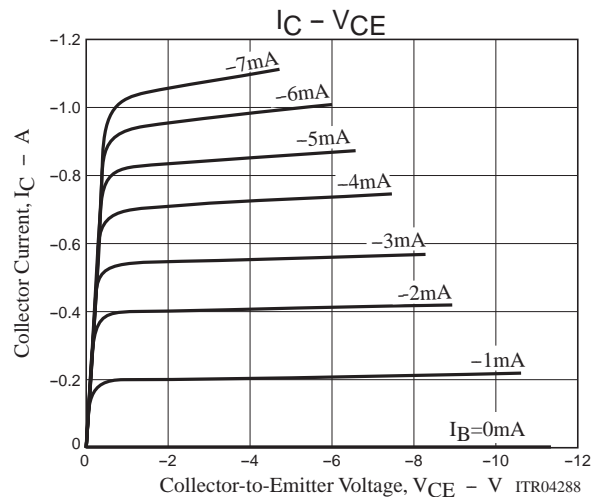
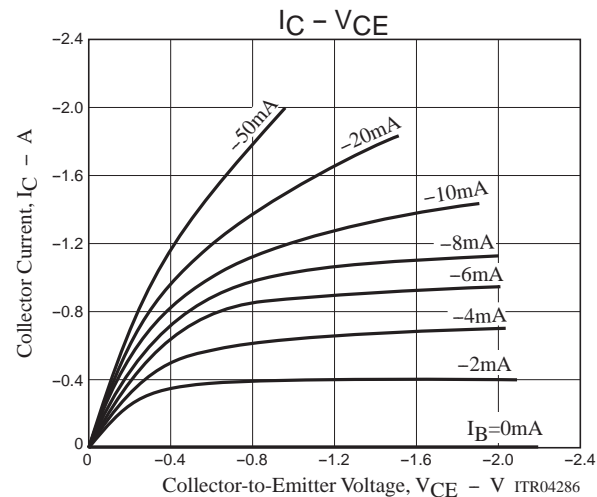

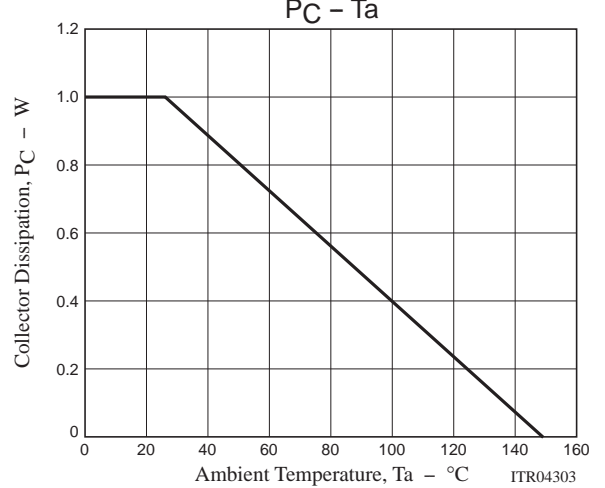
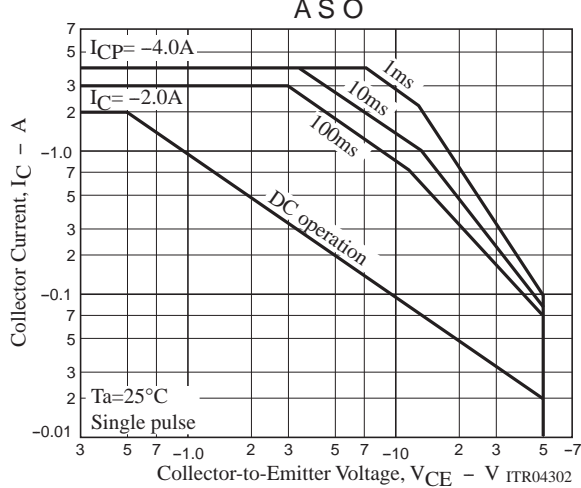
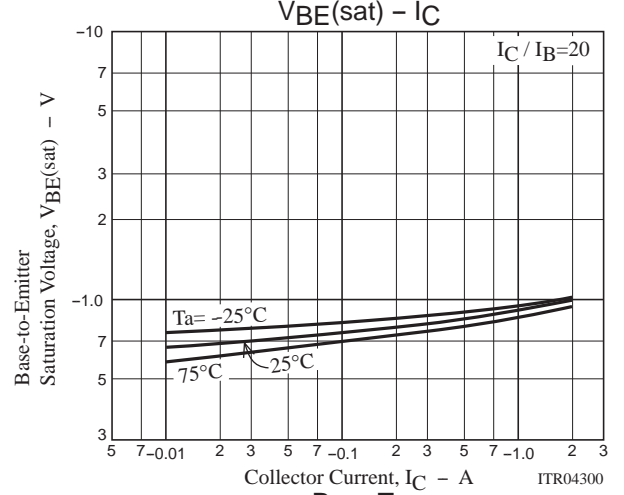
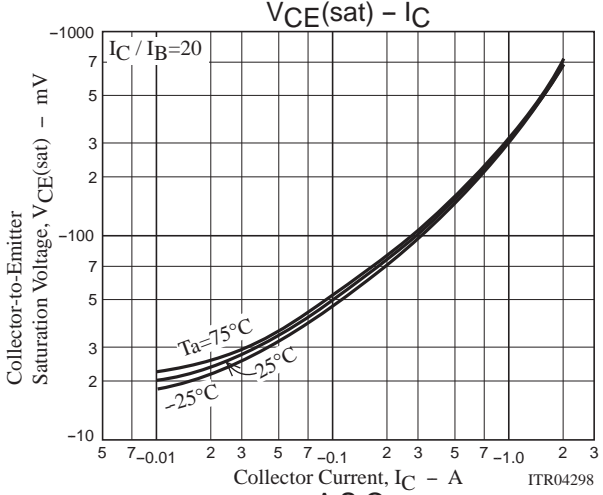
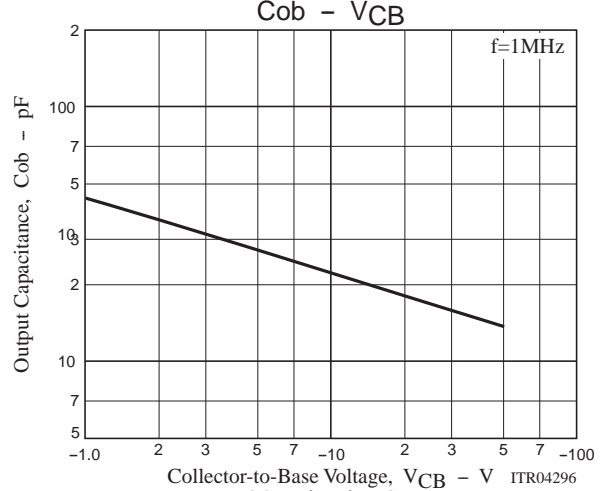
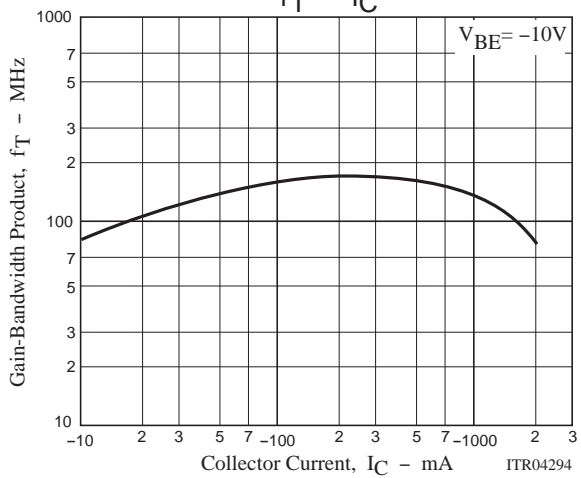
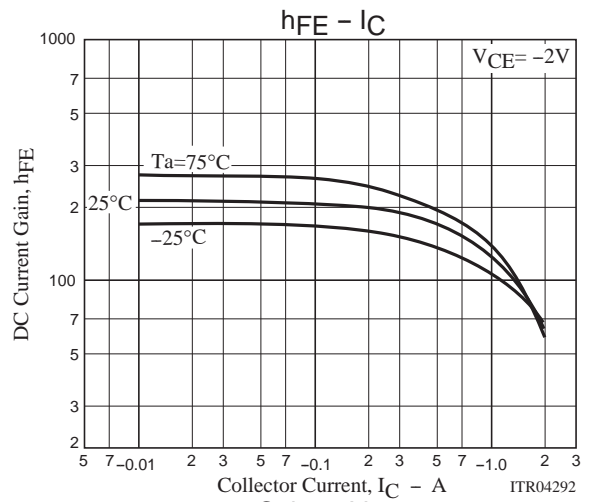
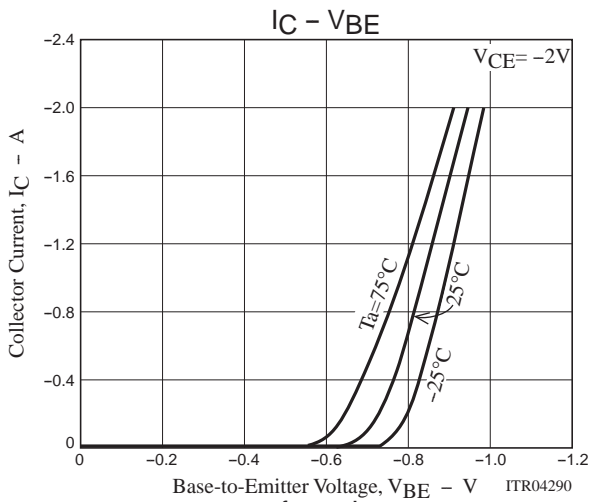

Bag Packing Specification

2SA1706S-AN, 2SA1706T-AN

NMP (Zigzag folding)

Storage package Outline name	Package type	Maximum Number of devices contained (pcs.)		Packing format	
		Inner box No.	Storage quantity	Outer box (C-6)	Outer box (C-8)
NMP	AN/AZ	C-3 Inner box Dimensions :mm(external) 330×45×125	2,500	8 inner boxes contained(20,000pcs.) Outer box Dimensions:mm(external) 585×345×195	4 inner boxes contained(10,000pcs.) Outer box Dimensions:mm(external) 345×300×195

1. Packing format

Packing method

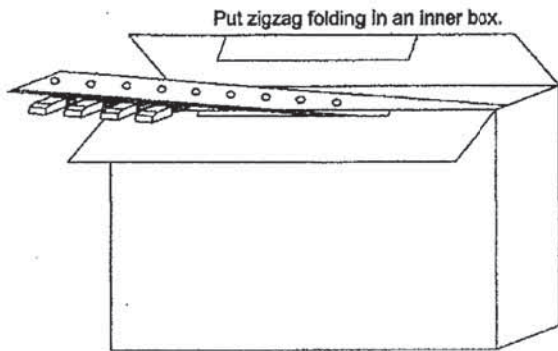

2. Bar code label

(Unit : mm)

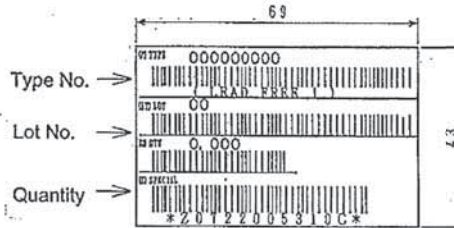

*LEAD FREE 1:

Lead-free External terminal surface treatment product.

2. Taping specifications

2-1. Carrier tape size (Unit:mm)

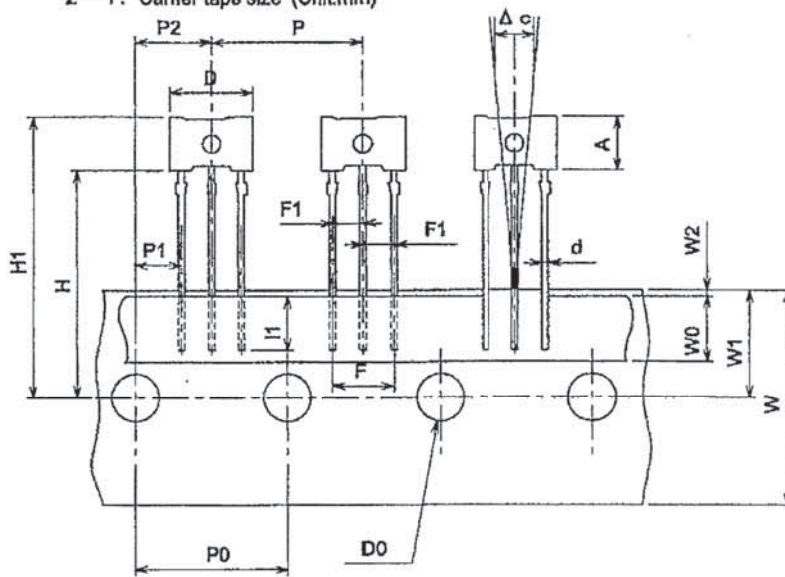

Marking surface

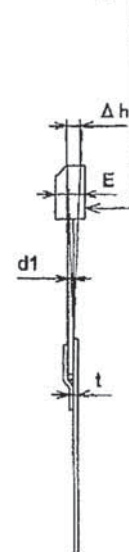

2-2. Taping size standard

Item	Symbol	Standard	Tolerance
Work piece outside diameter	D	6.9	±0.2
	E	2.5	±0.2
Work piece height	A	4.5	±0.2
Lead wire diameter	d	0.5	±0.1
Lead wire thickness	d1	0.45	±0.1
Bonded lead wire	I1	3.0MIN	
Pitch between products	P	12.7	±0.5
Pitch between perforations	P0	12.7	±0.2
Total pitch for 21 perforations	P0×20	254.0	±1.0
Distance between lead wire	F	5.0	+0.8 -0.2
Lead wire pitch distance	F1	2.54	+0.4 -0.1
Displacement of perforations	P1	3.81	±0.3
	P2	6.35	±0.3
Displacement of tape	W2	0 ~ 0.5	

Unit:mm

Item	Symbol	Standard	Tolerance
Tape width	W	18.0	±0.5
Adhesive tape	W0	6.0	±0.5
Displacement of perforations	W1	9.0	±0.5
Work piece bottom surface position	H	19.0	+1.0 -0.5
Work piece upper limit position	H1	23.5	±1.0
Perforations diameter	D0	φ4.0	±0.2
Tape thickness (total thickness)	t	0.6	±0.2
Product inclination	Δc	0	±0.7
Product inclination	Δh	0	±1.0

2—3. Taping structure

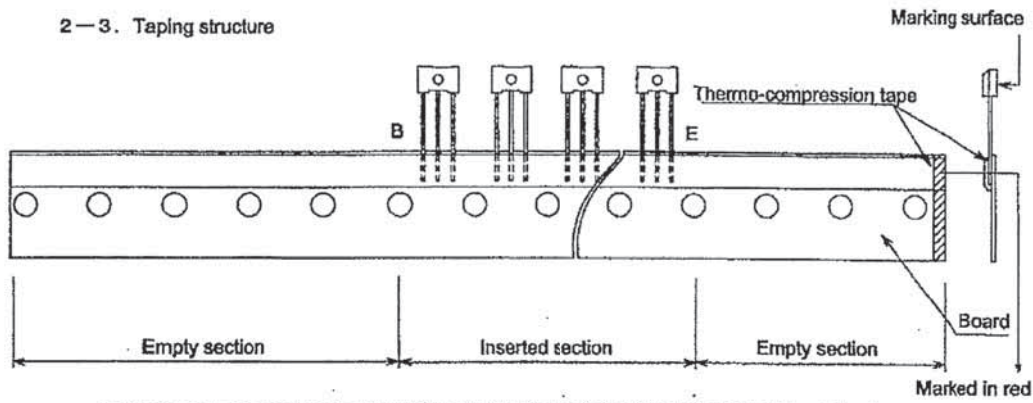

- Provide an empty section for about three to five pieces in leading and end portions of the tape.
- Provide an empty section in the fold-back portion.
- Provide marking in red to the E-side end of the board.

Outline Drawing

2SA1706S-AN, 2SA1706T-AN

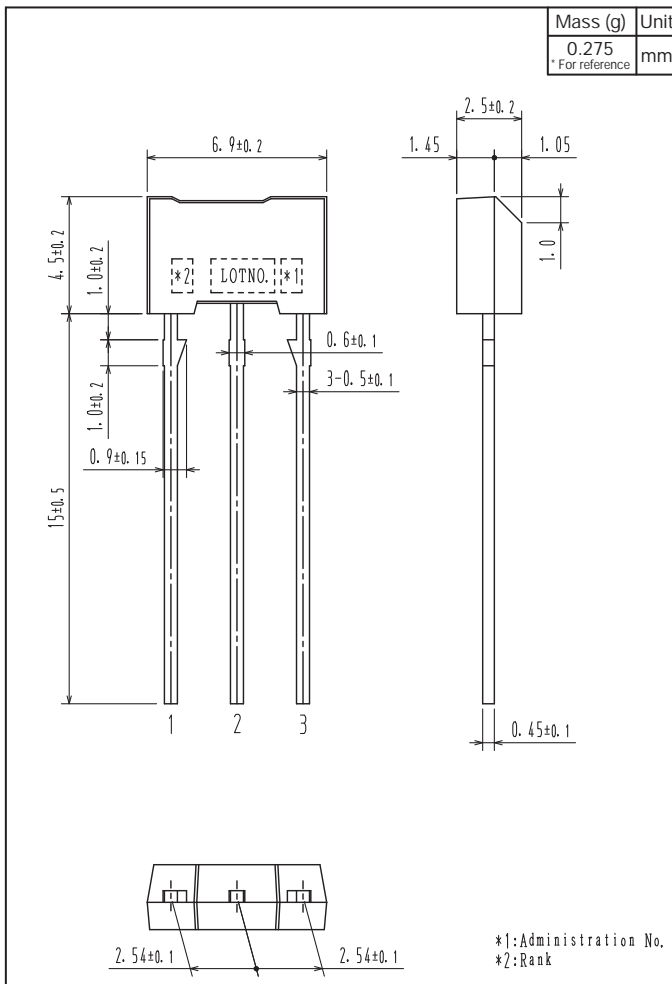

- Any and all SANYO Semiconductor Co.,Ltd. products described or contained herein are, with regard to "standard application", intended for the use as general electronics equipment. The products mentioned herein shall not be intended for use for any "special application" (medical equipment whose purpose is to sustain life, aerospace instrument, nuclear control device, burning appliances, transportation machine, traffic signal system, safety equipment etc.) that shall require extremely high level of reliability and can directly threaten human lives in case of failure or malfunction of the product or may cause harm to human bodies, nor shall they grant any guarantee thereof. If you should intend to use our products for new introduction or other application different from current conditions on the usage of automotive device, communication device, office equipment, industrial equipment etc. , please consult with us about usage condition (temperature, operation time etc.) prior to the intended use. If there is no consultation or inquiry before the intended use, our customer shall be solely responsible for the use.
- Specifications of any and all SANYO Semiconductor Co.,Ltd. products described or contained herein stipulate the performance, characteristics, and functions of the described products in the independent state, and are not guarantees of the performance, characteristics, and functions of the described products as mounted in the customer's products or equipment. To verify symptoms and states that cannot be evaluated in an independent device, the customer should always evaluate and test devices mounted in the customer's products or equipment.
- SANYO Semiconductor Co.,Ltd. assumes no responsibility for equipment failures that result from using products at values that exceed, even momentarily, rated values (such as maximum ratings, operating condition ranges, or other parameters) listed in products specifications of any and all SANYO Semiconductor Co.,Ltd. products described or contained herein.
- Regarding monolithic semiconductors, if you should intend to use this IC continuously under high temperature, high current, high voltage, or drastic temperature change, even if it is used within the range of absolute maximum ratings or operating conditions, there is a possibility of decrease reliability. Please contact us for a confirmation.
- SANYO Semiconductor Co.,Ltd. strives to supply high-quality high-reliability products, however, any and all semiconductor products fail or malfunction with some probability. It is possible that these probabilistic failures or malfunction could give rise to accidents or events that could endanger human lives, trouble that could give rise to smoke or fire, or accidents that could cause damage to other property. When designing equipment, adopt safety measures so that these kinds of accidents or events cannot occur. Such measures include but are not limited to protective circuits and error prevention circuits for safe design, redundant design, and structural design.
- In the event that any or all SANYO Semiconductor Co.,Ltd. products described or contained herein are controlled under any of applicable local export control laws and regulations, such products may require the export license from the authorities concerned in accordance with the above law.
- No part of this publication may be reproduced or transmitted in any form or by any means, electronic or mechanical, including photocopying and recording, or any information storage or retrieval system, or otherwise, without the prior written consent of SANYO Semiconductor Co.,Ltd.
- Any and all information described or contained herein are subject to change without notice due to product/technology improvement, etc. When designing equipment, refer to the "Delivery Specification" for the SANYO Semiconductor Co.,Ltd. product that you intend to use.
- Upon using the technical information or products described herein, neither warranty nor license shall be granted with regard to intellectual property rights or any other rights of SANYO Semiconductor Co.,Ltd. or any third party. SANYO Semiconductor Co.,Ltd. shall not be liable for any claim or suits with regard to a third party's intellectual property rights which has resulted from the use of the technical information and products mentioned above.

This catalog provides information as of October, 2012. Specifications and information herein are subject to change without notice.